



Artisan Technology Group is your source for quality new and certified-used/pre-owned equipment

- FAST SHIPPING AND DELIVERY
- TENS OF THOUSANDS OF IN-STOCK ITEMS
- EQUIPMENT DEMOS
- HUNDREDS OF MANUFACTURERS SUPPORTED
- LEASING/MONTHLY RENTALS
- ITAR CERTIFIED SECURE ASSET SOLUTIONS

SERVICE CENTER REPAIRS

Experienced engineers and technicians on staff at our full-service, in-house repair center

*InstraView*SM REMOTE INSPECTION

Remotely inspect equipment before purchasing with our interactive website at www.instraview.com ↗

WE BUY USED EQUIPMENT

Sell your excess, underutilized, and idle used equipment. We also offer credit for buy-backs and trade-ins. www.artisanng.com/WeBuyEquipment ↗

LOOKING FOR MORE INFORMATION?

Visit us on the web at www.artisanng.com ↗ for more information on price quotations, drivers, technical specifications, manuals, and documentation

Contact us: (888) 88-SOURCE | sales@artisanng.com | www.artisanng.com

Threaded fittings







FESTO



Threaded fittings

Product range overview









Design	Version	Type	Connection D1			Connection D2			→ Page/ Internet
			M thread	G thread ¹⁾	R thread ¹⁾	M thread	G thread ¹⁾	R thread ¹⁾	
Straight type	Blanking plug								
		B	M3	-	-	-	-	-	6
			M5						
			M7						
			-	G1/8					
				G1/4					
				G3/8					
				G1/2					
				G3/4					
			G1						
	Sleeve								
		NPFB-S	M5	-	-	-	-	-	12
			-	G1/8					
				G1/4					
				G3/8					
			G1/2						
	QM	M5	-	-	-	-	-	10	
		-	G1/8						
			G1/4						
			G3/8						
			G1/2						
	QM	M5	-	-	M5	-	-	10	
		-	G1/8			-	G1/8		
			G1/4				G1/4		
			G3/8				G3/8		
			G1/2				G1/2		
Reducing sleeve									
	NPFB-R	-	G1/8	-	-	G3/8	-	12	
				G1/2			G3/4		
	QMR	-	G1/8	-	M5	-	-	11	
				G1/4		-	G1/8		
				G3/8			G1/4		
				G1/2			G3/8		
Extension									
	NPFB-E...	-	G1/8	-	-	G1/8	-	13	
				G1/4			G1/4		
				G3/8			G3/8		
				G1/2			G1/2		

1) Sealing of the parallel threaded fittings NPFB with thread sealing tape GWB-0,1 Part No. 9076 is recommended.

Threaded fittings

Product range overview



Design	Version	Type	Connection D1			Connection D2			→ Page/ Internet	
			M thread	G thread ¹⁾	R thread ¹⁾	M thread	G thread ¹⁾	R thread ¹⁾		
Straight type	Double nipple									
		NPFB-D	M5	–	–	M5	–	–	14	
			M7	–	–	–	G1/8	–		
			–	G1/8	–	–	G1/8, G1/4, G3/8	–		
			–	G1/4	–	–	G1/4, G3/8, G1/2	–		
			–	G3/8	–	–	G3/8, G1/2	–		
			–	G1/2	–	–	G1/2	–		
			–	–	R1/8	–	–	R1/8, R1/4, R3/8		–
			–	–	R1/4	–	–	R1/4, R3/8, R1/2		–
			–	–	R3/8	–	–	R3/8, R1/2		–
			–	–	R1/2	–	–	R1/2, R3/4		–
	–	–	R3/4	–	–	R3/4	–			
	–	–	R1	–	–	R1	–			
		E	M3	–	–	M3	–	–	8	
			M5	–	–	M5	G1/8	–		
M7			–	–	–	G1/8	–			
–			G1/8	–	–	G1/8, G1/4, G3/8	–			
–			G1/4	–	–	G1/4, G3/8, G1/2	–			
–			G3/8	–	–	G3/8, G1/2	–			
–			G1/2	–	–	G1/2, G3/4	–			
–	G3/4	–	–	G3/4	–					
	ESK	–	–	R1/8	–	–	R1/8, R1/4, R3/8	9		
		–	–	R1/4	–	–	R1/4, R3/8, R1/2			
		–	–	R3/8	–	–	R3/8, R1/2			
		–	–	R1/2	–	–	R1/2			
Reducing nipple – Female thread/male thread										
	NPFB-R	M5	–	–	–	G1/8	–	15		
		–	G1/8	–	–	G1/4, G3/8	–			
		–	G1/4	–	–	G3/8	–			
		–	G3/8	–	–	G1/2	–			
Reducing nipple – Male thread/female thread										
	NPFB-R	–	G1/8	–	M5	–	–	15		
		–	G1/4	–	–	G1/8	–			
		–	G3/8	–	–	G1/8, G1/4	–			
		–	G1/2	–	–	G1/4, G3/8	–			
		–	G3/4	–	–	G1/2	–			
	D	M3	–	–	M5	–	–	7		
		M5	–	–	M7	G1/8, G1/4	–			
		M7	–	–	–	G1/8	–			
		–	G1/8	–	–	G1/4, G3/8	–			
		–	G1/4	–	–	G3/8, G1/2, G3/4	–			
		–	G3/8	–	–	G1/2, G3/4	–			
		–	G1/2	–	–	G3/4, G1	–			
		–	G3/4	–	–	G1	–			

1) Sealing of the parallel threaded fittings NPFB with thread sealing tape GWB-0,1 Part No. 9076 is recommended.

Threaded fittings

Product range overview











Design	Version	Type	Connection D1			Connection D2			→ Page/ Internet
			M thread	G thread ¹⁾	R thread ¹⁾	M thread	G thread ¹⁾	R thread ¹⁾	
Straight type 	Female bulkhead fitting								
	SCM	M5	–	–	–	–	–	9	
		–	G 1/8	–	–	–	–		
		–	G 1/4	–	–	–	–		
		–	G 3/8	–	–	–	–		
–	G 1/2	–	–	–	–				
L-shape 	Elbow fitting – Female thread								
	NPFB-L	M5	–	–	–	–	–	16	
		–	G 1/8	–	–	–	–		
		–	G 1/4	–	–	–	–		
		–	G 3/8	–	–	–	–		
		–	G 1/2	–	–	–	–		
		–	G 3/4	–	–	–	–		
	–	G 1	–	–	–	–			
	Elbow fitting – Male thread/female thread								
	NPFB-L	M5	–	–	M5	–	–	16	
		–	G 1/8	–	–	–	R 1/8		
		–	G 1/4	–	–	–	R 1/4		
		–	G 3/8	–	–	–	R 3/8		
–		G 1/2	–	–	–	R 1/2			
–		G 3/4	–	–	–	R 3/4			
–	G 1	–	–	–	R 1				
Elbow fitting – Male thread									
NPFB-L	M5	–	–	–	–	–	17		
	–	–	–	R 1/8	–	–			
	–	–	–	R 1/4	–	–			
	–	–	–	R 3/8	–	–			
	–	–	–	R 1/2	–	–			
	–	–	–	R 3/4	–	–			
–	–	–	R 1	–	–				
T-type 	T-fitting – Female thread								
	NPFB-T	M5	–	–	–	–	–	17	
		–	G 1/8	–	–	–	–		
		–	G 1/4	–	–	–	–		
		–	G 3/8	–	–	–	–		
		–	G 1/2	–	–	–	–		
		–	G 3/4	–	–	–	–		
	–	G 1	–	–	–	–			
	T-fitting – Female thread/male thread/female thread								
	NPFB-T	M5	–	–	M5	–	–	18	
		–	G 1/8	–	–	–	R 1/8		
–		G 1/4	–	–	–	R 1/4			
–		G 3/8	–	–	–	R 3/8			
–		G 1/2	–	–	–	R 1/2			
–		G 3/4	–	–	–	R 3/4			
–	G 1	–	–	–	R 1				

1) Sealing of the parallel threaded fittings NPFB with thread sealing tape GWB-0,1 Part No. 9076 is recommended.

Threaded fittings

Product range overview

Design	Version	Type	Connection D1			Connection D2			→ Page/ Internet	
			M thread	G thread ¹⁾	R thread ¹⁾	M thread	G thread ¹⁾	R thread ¹⁾		
T-type	T-fitting – Female thread/male thread/male thread									
		NPFB-T	–	G 1/8 G 1/4 G 3/8 G 1/2	–	–	–	R 1/8 R 1/4 R 3/8 R 1/2	18	
	T-fitting – Male thread									
		NPFB-T	–	–	R 1/8 R 1/4 R 3/8 R 1/2 R 3/4 R 1	–	–	–	19	
	T-fitting – Male thread/male thread/female thread									
		NPFB-T	–	–	R 1/8 R 1/4 R 3/8 R 1/2	–	G 1/8 G 1/4 G 3/8 G 1/2	–	19	
	T-fitting – Male thread/female thread/female thread									
		NPFB-T	M5 –	–	– R 1/8 R 1/4 R 3/8 R 1/2 R 3/4 R 1	M5 –	– G 1/8 G 1/4 G 3/8 G 1/2 G 3/4 G 1	–	20	
	Y-shape	Y-fitting – Female thread								
			NPFB-Y	–	G 1/8 G 1/4 G 3/8 G 1/2	–	–	–	–	20
		Y-fitting – Male thread/female thread/female thread								
		NPFB-Y	–	–	R 1/8 R 1/4 R 3/8 R 1/2	–	G 1/8 G 1/4 G 3/8 G 1/2	–	21	
X-shape	X-fitting – Female thread									
		NPFB-X	–	G 1/8 G 1/4 G 3/8 G 1/2	–	–	–	–	21	
	X-fitting – Male thread/female thread/female thread/female thread									
	NPFB-X	–	G 1/8 G 1/4 G 3/8 G 1/2	–	–	–	R 1/8 R 1/4 R 3/8 R 1/2	22		

1) Sealing of the parallel threaded fittings NPFB with thread sealing tape GWB-0,1 Part No. 9076 is recommended.

Threaded fittings

Technical data



Blanking plug B-M3-S9 with sealing ring

Material:
High-alloy stainless steel

Note on materials:
Free of copper and PTFE

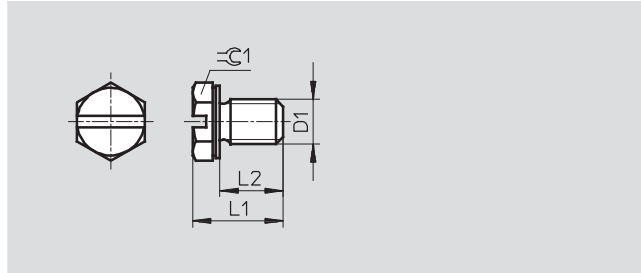

Blanking plug B-M5 with sealing ring

Material:
Aluminium

Note on materials:
Free of copper and PTFE

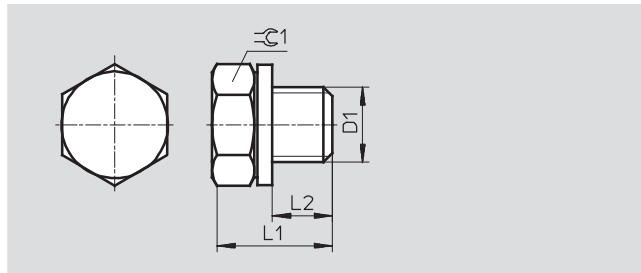

Blanking plug B with sealing ring

Material:
Steel

Note on materials:
Free of copper and PTFE

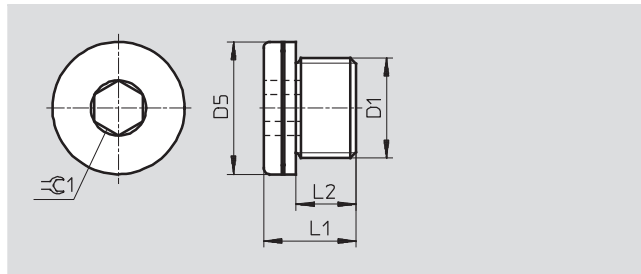

Dimensions and ordering data								
Connection	D5	L1	L2	$\approx C1$	Weight/piece [g]	Part No.	Type	PU ¹⁾
D1	\varnothing							
M thread								
M3	–	5.3	2.8	4.5	1	30979	B-M3-S9 ²⁾	10
M5	–	7.8	3.8	7	1	3843	B-M5	10
						534212	B-M5-100	100
	8	6.3	3.8	2.5	2	174308	B-M5-B	10
M7	9.5	7.8	5.3	3	2	174309	B-M7	10
G thread								
G ¹ / ₈	14	11	6.4	5	5	3568	B- ¹ / ₈ ³⁾	10
						534213	B- ¹ / ₈ -100 ³⁾	100
G ¹ / ₄	18	15	9.8	6	15	3569	B- ¹ / ₄ ³⁾	10
						534214	B- ¹ / ₄ -50 ³⁾	50
G ³ / ₈	22	15	9.8	8	22	3570	B- ³ / ₈ ³⁾	10
						534215	B- ³ / ₈ -20 ³⁾	20
G ¹ / ₂	26	18	11.65	10	43	3571	B- ¹ / ₂ ³⁾	10
						534216	B- ¹ / ₂ -20 ³⁾	20
G ³ / ₄	32	20	13.05	12	73	3572	B- ³ / ₄ ³⁾	1
G1	39	21	14	17	153	5763	B-1	1

1) Packaging unit quantity
2) Corrosion and acid resistant version
3) Conforms to RoHS

Threaded fittings

Technical data

Reducing nipple D with sealing ring

Material:
Brass

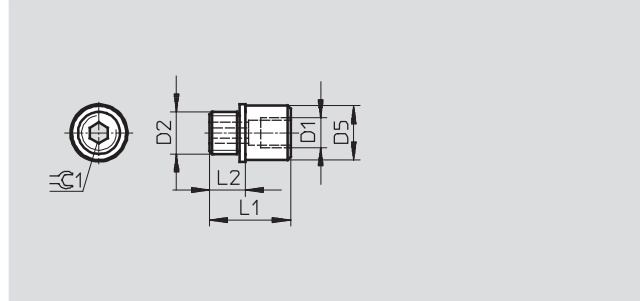

Dimensions and ordering data									
Connection		D5	L1	L2	≈C 1	Weight/piece [g]	Part No.	Type	PU ¹⁾
D1	D2								
M5	M7	9	13.5	6	3	43	161359	D-M5I-M7A-ISK	10

1) Packaging unit quantity

Reducing nipple D with sealing ring

Material:
Brass
D-M3I-M5A-S9:
High-alloy stainless steel

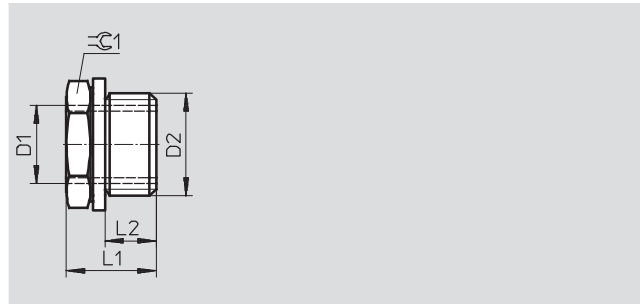

Dimensions and ordering data									
Connection		L1	L2	≈C 1	Weight/piece [g]	Part No.	Type	PU ¹⁾	
D1	D2								
M thread									
M3	M5	6.3	3.8	7	1	30980	D-M3I-M5A-S9 ²⁾	10	
M5 6 mm deep	G ¹ / ₈	9.5	4.9	13	10	3842	D-M5I- ¹ / ₈ A ³⁾	10	
						534208	D-M5I- ¹ / ₈ A-100	100	
M5	G ¹ / ₄	12	5.8	17	12	197632	D-M5I- ¹ / ₄ A	10	
M7	G ¹ / ₈	9.5	4.9	13	-	534144	D-M7I- ¹ / ₈ A	10	
G ¹ / ₈	G ¹ / ₄	12	5.8	17	8	3577	D- ¹ / ₈ I- ¹ / ₄ A	10	
						534209	D- ¹ / ₈ I- ¹ / ₄ A-100	100	
	G ³ / ₈	14	6.8	19	-	534147	D- ¹ / ₈ I- ³ / ₈ A	10	
G ¹ / ₄	G ³ / ₈	14	6.8	19	14	3581	D- ¹ / ₄ I- ³ / ₈ A	10	
						534210	D- ¹ / ₄ I- ³ / ₈ A-50	50	
	G ¹ / ₂	15.5	8.15	24	36	197633	D- ¹ / ₄ I- ¹ / ₂ A	10	
G ³ / ₈	G ³ / ₄	20.4	9.05	32	-	534145	D- ¹ / ₄ I- ³ / ₄ A	10	
						G ¹ / ₂	15.5	8.15	24
	G ³ / ₄	20.4	9.05	32	-	534146	D- ³ / ₈ I- ³ / ₄ A	10	
G ¹ / ₂	G ³ / ₄	20.4	14	32	45	3588	D- ¹ / ₂ I- ³ / ₄ A	1	
	G1	21	13	36	110	197634	D- ¹ / ₂ I-1A	1	
G ³ / ₄	G1	21	13	36	55	9168	D- ³ / ₄ I-1A	1	

- 1) Packaging unit quantity
- 2) Corrosion and acid resistant version
- 3) Free of copper and PTFE

Threaded fittings

Technical data



Double nipple E
with 2 sealing rings

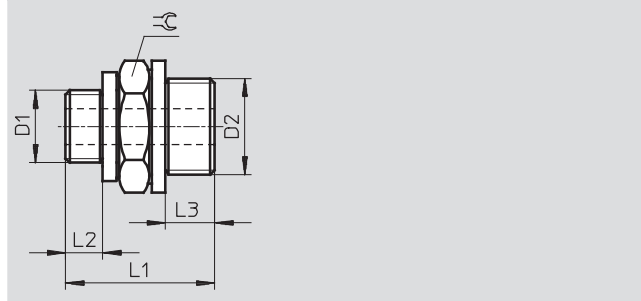

Dimensions and ordering data										
Connection		Nominal size	L1	L2	L3	±	Weight/piece [g]	Part No.	Type	PU ¹⁾
D1	D2									
M thread – High-alloy steel										
M3	M3	1.7	10	2.8	2.8	4.5	1	30987	E-M3-M3-S9 ^{2) 3)}	10
M thread – Steel										
M5	M5	2.5	12.6	3.8	3.8	7	2	4139	E-M5-M5 ³⁾	10
	G ¹ / ₈	2.5	15.3	3.8	4.9	13	1	4138	E-M5- ¹ / ₈ ³⁾	10
								534204	E-M5- ¹ / ₈ -100 ³⁾	100
G thread – Aluminium										
G ¹ / ₈	G ¹ / ₈	4.5	17	4.9	4.9	13	1	3573	E- ¹ / ₈ - ¹ / ₈ ³⁾	10
	G ¹ / ₄	4.5	19.5	4.9	5.8	17	1	3574	E- ¹ / ₈ - ¹ / ₄ ³⁾	10
								534205	E- ¹ / ₈ - ¹ / ₄ -100 ³⁾	100
G ¹ / ₄	G ¹ / ₄	6.5	21	5.8	5.8	17	1	3575	E- ¹ / ₄ - ¹ / ₄ ³⁾	10
	G ³ / ₈	6.5	22	5.8	6.8	19	10	3576	E- ¹ / ₄ - ³ / ₈ ³⁾	10
								534206	E- ¹ / ₄ - ³ / ₈ -50 ³⁾	50
G ³ / ₈	G ³ / ₈	9.0	23	6.8	6.8	19	10	3578	E- ³ / ₈ - ³ / ₈ ³⁾	10
	G ¹ / ₂	9.0	26.5	6.8	8.15	24	20	3579	E- ³ / ₈ - ¹ / ₂ ³⁾	1
								534207	E- ³ / ₈ - ¹ / ₂ -20 ³⁾	20
G ¹ / ₂	G ¹ / ₂	13.0	28	8.15	8.15	24	20	3580	E- ¹ / ₂ - ¹ / ₂ ³⁾	1
	G ³ / ₄	13.0	30.5	8.5	9.05	32	35	3582	E- ¹ / ₂ - ³ / ₄ ³⁾	1
G ³ / ₄	G ³ / ₄	18.0	32	9.5	9.05	32	30	3584	E- ³ / ₄ - ³ / ₄ ³⁾	1
M thread – Brass										
M7	G ¹ / ₈	4.5	17.7	5.3	4.9	13		534148	E-M7- ¹ / ₈ -MS	10
G thread – Brass										
G ¹ / ₈	G ¹ / ₈	4.5	17	4.9	4.9	13	10	15621	E- ¹ / ₈ - ¹ / ₈ -MS	10
	G ¹ / ₄	4.5	19.5	4.9	5.8	17	20	15622	E- ¹ / ₈ - ¹ / ₄ -MS	10
	G ³ / ₈	5.3	20.4	4.9	6.8	19	25	534150	E- ¹ / ₈ - ³ / ₈ -MS	10
G ¹ / ₄	G ¹ / ₄	6.5	21	5.8	5.8	17	20	15623	E- ¹ / ₄ - ¹ / ₄ -MS	10
	G ³ / ₈	6.5	22	5.8	6.8	19	30	15624	E- ¹ / ₄ - ³ / ₈ -MS	10
	G ¹ / ₂	8	25.5	5.8	8.15	24	30	534149	E- ¹ / ₄ - ¹ / ₂ -MS	10
G ³ / ₈	G ³ / ₈	9	23	6.8	6.8	19	30	15625	E- ³ / ₈ - ³ / ₈ -MS	10
	G ¹ / ₂	9	26.5	6.8	8.15	24	53	15626	E- ³ / ₈ - ¹ / ₂ -MS	1
G ¹ / ₂	G ¹ / ₂	13	28	8.15	8.15	24	52	15627	E- ¹ / ₂ - ¹ / ₂ -MS	1
	G ³ / ₄	13	30.5	8.15	9.05	32	100	15628	E- ¹ / ₂ - ³ / ₄ -MS	1
G ³ / ₄	G ³ / ₄	18	32	9.05	9.05	32	100	15629	E- ³ / ₄ - ³ / ₄ -MS	1

- 1) Packaging unit quantity
- 2) Corrosion and acid resistant version
- 3) Free of copper and PTFE

Threaded fittings

Technical data



Double nipple ESK

adjustable for angular compensation

Material:
Brass

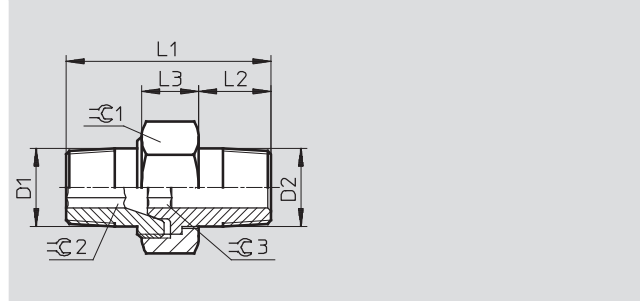

Dimensions and ordering data										
Connection		L1	L2	L3	⊙C1	⊙C2	⊙C3	Part No.	Type	PU ¹⁾
D1	D2									
R1/8	R1/8	27	9	8.5	15	5	5	151520	ESK-1/8-1/8	1
	R1/4	30.6	12	9.5	19	5	6	534151	ESK-1/8-1/4	1
	R3/8	34.5	13	10	22	5	8	534155	ESK-1/8-3/8	1
R1/4	R1/4	34	12	9.5	19	6	6	151521	ESK-1/4-1/4	1
	R3/8	36	13	10	22	6	8	534152	ESK-1/4-3/8	1
	R1/2	40.5	16	12	27	6	12	534153	ESK-1/4-1/2	1
R3/8	R3/8	36	13	10	22	8	8	151522	ESK-3/8-3/8	1
	R1/2	44	16	12	27	8	12	534154	ESK-3/8-1/2	1
R1/2	R1/2	44	16	12	27	12	12	151523	ESK-1/2-1/2	1

1) Packaging unit quantity

Female bulkhead connector SCM

Material:
Blue anodised aluminium

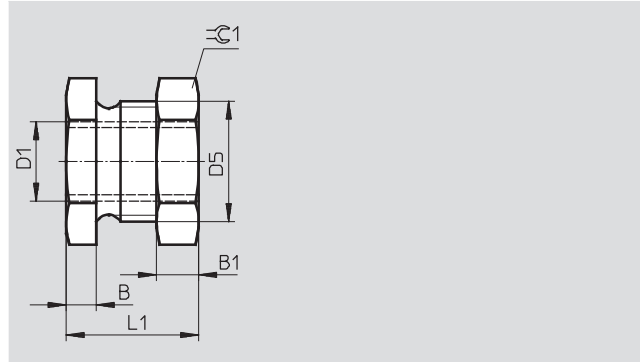

Dimensions and ordering data										
Connection	D5	B	B1	L1	⊙C1	Weight/piece [g]	Part No.	Type	PU ¹⁾	
M5	M10x1	4	3.5	15.5	13	5	9969	SCM-M5	1	
G1/8	M14x1.5	5	5	20	17	10	9970	SCM-1/8	1	
G1/4	M20x1.5	5	7	22	24	28	9971	SCM-1/4	1	
G3/8	M24x1.5	8	8.5	26.5	27	34	9972	SCM-3/8	1	
G1/2	M30x1.5	8	10.5	28.5	36	78	9973	SCM-1/2	1	

1) Packaging unit quantity

Threaded fittings

Technical data



Pipe coupling sleeve QM

Material:
Blue anodised aluminium
QM-M5-M5:
Steel

Note on materials:
Free of copper and PTFE
Conforms to RoHS

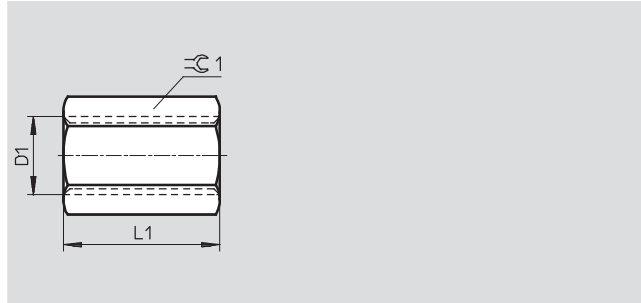

Dimensions and ordering data						
Connection	L1	$\varnothing 1$	Weight/piece [g]	Part No.	Type	PU ¹⁾
M5	12	7	1	3560	QM-M5-M5	10
G1/8	22	13	6	2254	QM-1/8-1/8	10
G1/4	26	17	9	2255	QM-1/4-1/4	10
G3/8	32	22	19	2256	QM-3/8-3/8	10
G1/2	36	27	31	2257	QM-1/2-1/2	1
G3/4	36	32	36	4226	QM-3/4-3/4	1
G1	40	41	80	9968	QM-1-1	1

1) Packaging unit quantity

Pipe coupling sleeve QM with sealing ring

Material:
Blue anodised aluminium
QM-M5-A/I:
Steel

Note on materials:
Free of copper and PTFE

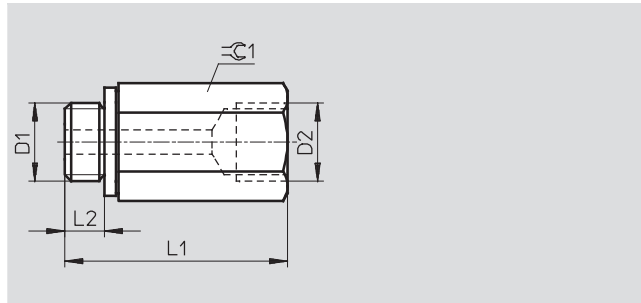

Dimensions and ordering data							
Connection	L1	L2	$\varnothing 1$	Weight/piece [g]	Part No.	Type	PU ¹⁾
M5	18.5	3.8	7	4	36169	QM-M5-A/I	10
G1/8	25.6	4.9	13	7	36170	QM-1/8-A/I	10
G1/4	36	5.8	17	15	36171	QM-1/4-A/I	10
G3/8	37.8	6.8	19	16	36172	QM-3/8-A/I	10
G1/2	49	8.15	24	36	187387	QM-1/2-A/I	1

1) Packaging unit quantity

Threaded fittings

Technical data

Reducing sleeve QMR

Material:
Nickel plated brass

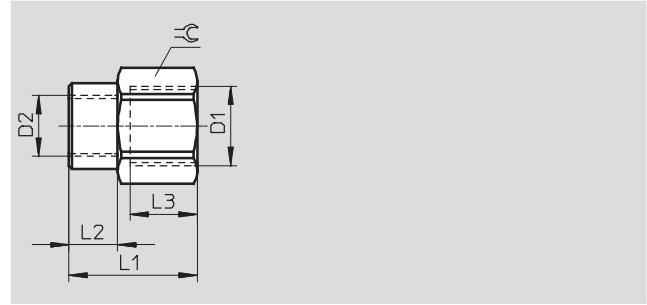

Dimensions and ordering data										
Connection	Nominal size [mm]	Connection	L1	L2	L3	≅	Weight/piece [g]	Part No.	Type	PU ¹⁾
D1		D2								
M thread										
G ¹ / ₈	2.6	M5	17	7	7	14	12	153281	QMR- ¹ / ₈ -M5-B	10
G thread										
G ¹ / ₄	5.3	G ¹ / ₈	21	8	9	17	22	153282	QMR- ¹ / ₄ - ¹ / ₈ -B	10
G ³ / ₈	6.9	G ¹ / ₄	25	11	11	21	34	153283	QMR- ³ / ₈ - ¹ / ₄ -B	10
G ¹ / ₂	10.7	G ³ / ₈	33	14	14	24	55	153284	QMR- ¹ / ₂ - ³ / ₈ -B	1

1) Packaging unit quantity

Threaded fittings NPFB

Technical data

Sleeve NPFB-S

Operating pressure:
-0.95 ... +40 bar
Ambient temperature:
-20 ... +150 °C
Operating medium:
Compressed air in accordance with
ISO 8573-1:2010 [7:-:-]

Material:
Nickel-plated brass

Note on material:
Conforms to RoHS

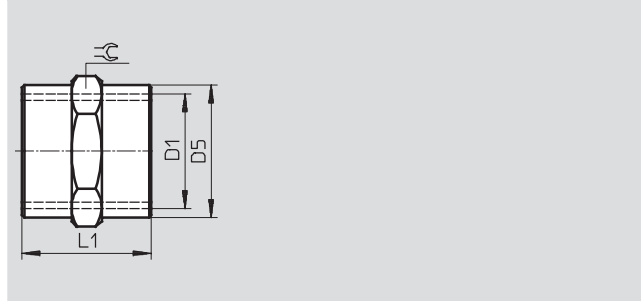

Dimensions and ordering data							
Connection	D5	L1	≅	Weight/piece [g]	Part No.	Type	PU ¹⁾
D1	∅						
M thread							
M5	7.5	11	8	3	547809	NPFB-S-2M5-F	10
G thread							
G ¹ / ₈	13.8	15	14	11	547810	NPFB-S-2G18-F	10
G ¹ / ₄	16.8	22	17	20	547811	NPFB-S-2G14-F	10
G ³ / ₈	21.8	24	22	38	547812	NPFB-S-2G38-F	10
G ¹ / ₂	25.5	30	26	55	547813	NPFB-S-2G12-F	10
G ³ / ₄	31.5	32	32	91	547814	NPFB-S-2G34-F	10

1) Packaging unit quantity

Reducing sleeve NPFB-R

Operating pressure:
-0.95 ... +40 bar
Ambient temperature:
-20 ... +150 °C
Operating medium:
Compressed air in accordance with
ISO 8573-1:2010 [7:-:-]

Material:
Nickel-plated brass

Note on material:
Conforms to RoHS

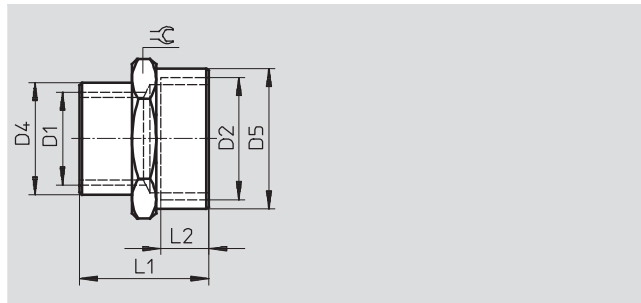

Dimensions and ordering data										
Connection		D4	D5	L1	L2	≅	Weight/piece [g]	Part No.	Type	PU ¹⁾
D1	D2	∅	∅							
G ¹ / ₈	G ³ / ₈	13.8	21.8	20	10	22	30	547815	NPFB-R-G38-G18-F	10
G ¹ / ₂	G ³ / ₄	25.5	31.5	30	13	32	83	547816	NPFB-R-G34-G12-F	10

1) Packaging unit quantity

Threaded fittings NPFB

Technical data

Extension NPFB-E...

Operating pressure:
 -0.95 ... +40 bar
 Ambient temperature:
 -20 ... +150 °C
 Operating medium:
 Compressed air in accordance with
 ISO 8573-1:2010 [7:--:-]

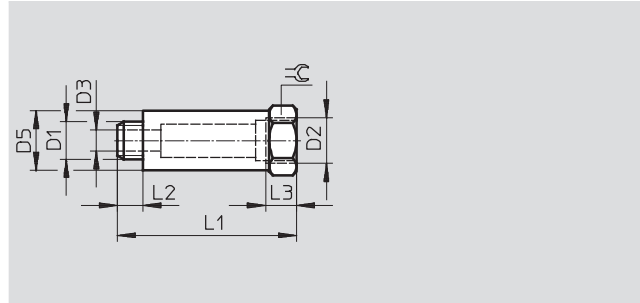

Material:
 Nickel-plated brass

Note on material:
 Conforms to RoHS

Dimensions and ordering data											
Connection		D3	D5	L1	L2	L3	≅	Weight/piece [g]	Part No.	Type	PU ¹⁾
D1	D2	∅	∅								
E1											
G1/8	G1/8	5	13.5	22	6	6.5	14	17	547822	NPFB-E1-2G18-FM	10
G1/4	G1/4	7	16.5	28	8	10	17	28	547823	NPFB-E1-2G14-FM	10
G3/8	G3/8	11	21.8	32	9	10	22	40	547824	NPFB-E1-2G38-FM	10
G1/2	G1/2	14	25.5	35	10	11	26	55	547825	NPFB-E1-2G12-FM	10
E2											
G1/8	G1/8	5	13.5	32	6	6.5	14	25	547826	NPFB-E2-2G18-FM	10
G1/4	G1/4	7	16.5	35	8	10	17	35	547827	NPFB-E2-2G14-FM	10
E3											
G1/8	G1/8	5	13.5	42	6	6.5	14	32	547828	NPFB-E3-2G18-FM	10
G1/4	G1/4	7	16.5	51	8	10	17	51	547829	NPFB-E3-2G14-FM	10
E4											
G1/8	G1/8	5	13.5	51	6	6.5	14	40	547830	NPFB-E4-2G18-FM	10

1) Packaging unit quantity

Threaded fittings NPFB

Technical data



Double nipple NPFB-D

Operating pressure:
-0.95 ... +40 bar
Ambient temperature:
-20 ... +150 °C
Operating medium:
Compressed air in accordance with
ISO 8573-1:2010 [7:-:-]

Material:
Nickel-plated brass

Note on material:
Conforms to RoHS



G thread

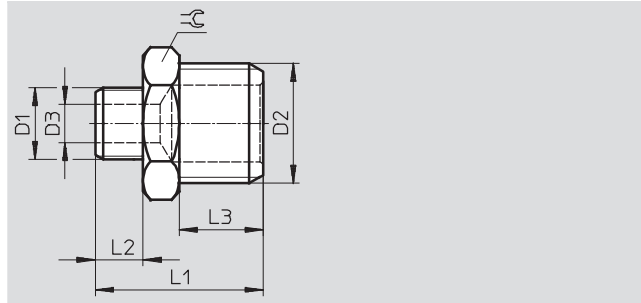

R thread

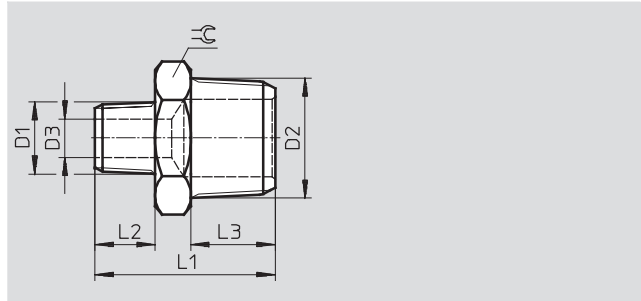

Dimensions and ordering data										
Connection		D3 ∅	L1	L2	L3	=C	Weight/piece [g]	Part No.	Type	PU ¹⁾
D1	D2									
M thread										
M5	M5	2	11.5	4	4	8	3	550036	NPFB-D-2M5-M	10
M7	G ³ / ₈	4	14.5	4	6	14	7	547799	NPFB-D-M7-G18-M	10
G thread										
G ¹ / ₈	G ¹ / ₈	5.5	16.5	6	6	14	10	547800	NPFB-D-2G18-M	10
	G ¹ / ₄	5.5	19	6	8	17	16	547801	NPFB-D-G18-G14-M	10
	G ³ / ₈	5.5	20	6	9	19	21	547802	NPFB-D-G18-G38-M	10
G ¹ / ₄	G ¹ / ₄	8	21	8	8	17	17	547803	NPFB-D-2G14-M	10
	G ³ / ₈	8	22	8	9	19	23	547804	NPFB-D-G14-G38-M	10
	G ¹ / ₂	8	23.5	8	10	24	36	547805	NPFB-D-G14-G12-M	10
G ³ / ₈	G ³ / ₈	11	23	9	9	19	24	547806	NPFB-D-2G38-M	10
	G ¹ / ₂	11	24.5	9	10	24	37	547807	NPFB-D-G38-G12-M	10
G ¹ / ₂	G ¹ / ₂	14	25.5	10	10	24	38	547808	NPFB-D-2G12-M	10
R thread										
R ¹ / ₈	R ¹ / ₈	5	20	8	8	12	11	547787	NPFB-D-2R18-M	10
	R ¹ / ₄	5	24	8	11	14	17	547788	NPFB-D-R18-R14-M	10
	R ³ / ₈	5.5	24.5	8	11.5	17	23	547789	NPFB-D-R18-R38-M	10
R ¹ / ₄	R ¹ / ₄	8	27	11	11	14	21	547790	NPFB-D-2R14-M	10
	R ³ / ₈	8	27.5	11	11.5	17	27	547791	NPFB-D-R14-R38-M	10
	R ¹ / ₂	8	30.5	11	14	22	44	547792	NPFB-D-R14-R12-M	10
R ³ / ₈	R ³ / ₈	11	28	11.5	11.5	17	30	547793	NPFB-D-2R38-M	10
	R ¹ / ₂	11	31	11.5	14	22	47	547794	NPFB-D-R38-R12-M	10
R ¹ / ₂	R ¹ / ₂	14	33.5	14	14	22	56	547795	NPFB-D-2R12-M	10
	R ³ / ₄	14	37.5	14	16.5	27	84	547796	NPFB-D-R12-R34-M	10
R ³ / ₄	R ³ / ₄	18.5	40	16.5	16.5	27	97	547797	NPFB-D-2R34-M	10
R1	R1	24.5	45.5	19	19	34	158	547798	NPFB-D-2R1-M	10

1) Packaging unit quantity

Threaded fittings NPFB

Technical data

Reducing nipple NPFB-R

Operating pressure:
-0.95 ... +40 bar
Ambient temperature:
-20 ... +150 °C
Operating medium:
Compressed air in accordance with
ISO 8573-1:2010 [7:--:-]

Material:
Nickel-plated brass

Note on material:
Conforms to RoHS

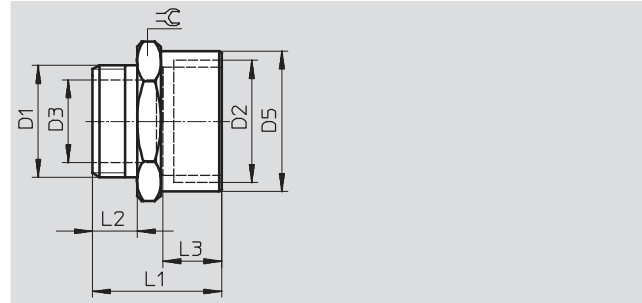

Dimensions and ordering data

Connection		D3 ∅	D5 ∅	L1	L2	L3	≡	Weight/piece [g]	Part No.	Type	PU ¹⁾
D1	D2										
M5	G $\frac{1}{8}$	2	13.8	15.5	4	6.5	14	11	547817	NPFB-R-G18-M5-FM	10
G $\frac{1}{8}$	G $\frac{1}{4}$	5.5	16.8	20.5	6	8	17	19	547818	NPFB-R-G14-G18-FM	10
	G $\frac{3}{8}$	5.5	21.8	23	6	10	22	35	547819	NPFB-R-G38-G18-FM	10
G $\frac{1}{4}$	G $\frac{3}{8}$	8	21.8	24	8	10	22	35	547820	NPFB-R-G38-G14-FM	10
G $\frac{3}{8}$	G $\frac{1}{2}$	11	25.5	29.5	9	11	26	51	547821	NPFB-R-G12-G38-FM	10

1) Packaging unit quantity

Reducing nipple NPFB-R

Operating pressure:
-0.95 ... +40 bar
Ambient temperature:
-20 ... +150 °C
Operating medium:
Compressed air in accordance with
ISO 8573-1:2010 [7:--:-]

Material:
Nickel-plated brass

Note on material:
Conforms to RoHS

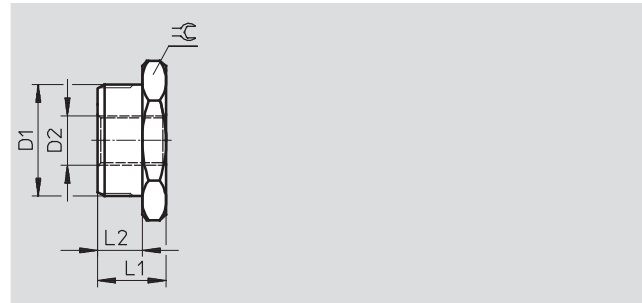

Dimensions and ordering data

Connection		L1	L2	≡	Weight/piece [g]	Part No.	Type	PU ¹⁾
D1	D2							
G $\frac{1}{8}$	M5	10.5	6	14	8	547831	NPFB-R-G18-M5-MF	10
G $\frac{1}{4}$	G $\frac{1}{8}$	13	8	17	13	547832	NPFB-R-G14-G18-MF	10
G $\frac{3}{8}$	G $\frac{1}{8}$	14	9	19	22	547833	NPFB-R-G38-G18-MF	10
	G $\frac{1}{4}$	14	9	19	16	547834	NPFB-R-G38-G14-MF	10
G $\frac{1}{2}$	G $\frac{1}{4}$	15.5	10	24	35	547835	NPFB-R-G12-G14-MF	10
	G $\frac{3}{8}$	15.5	10	24	28	547836	NPFB-R-G12-G38-MF	10
G $\frac{3}{4}$	G $\frac{1}{2}$	17.5	11	30	51	575668	NPFB-R-G34-G12-MF	10

1) Packaging unit quantity

Threaded fittings NPFB

Technical data



Elbow fitting NPFB-L

Operating pressure:
-0.95 ... +40 bar
Ambient temperature:
-20 ... +150 °C
Operating medium:
Compressed air in accordance with
ISO 8573-1:2010 [7:-:-]

Material:
Nickel-plated brass

Note on material:
Conforms to RoHS

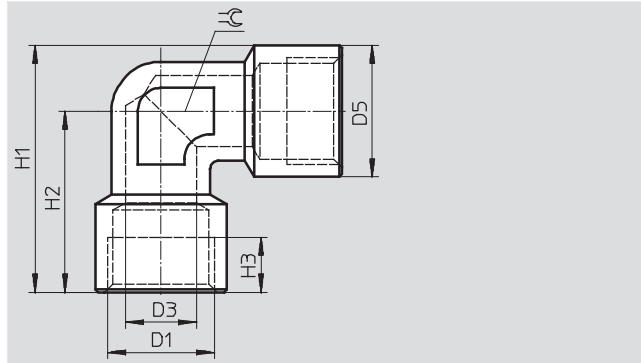

Dimensions and ordering data										
Connection	D3	D5	H1	H2	H3	∠	Weight/piece [g]	Part No.	Type	PU ¹⁾
D1	∅	∅								
M5	4.2	8.5	15.25	11	4	9	31	547715	NPFB-L-2M5-F	10
G1/8	6	13	26.5	20	7	10	19	547716	NPFB-L-2G18-F	10
G1/4	9	16	33.5	25.5	8	13	31	547717	NPFB-L-2G14-F	10
G3/8	10	20.5	39.25	29	10	17	61	547718	NPFB-L-2G38-F	10
G1/2	14	25.5	47.75	35	11	20	115	547719	NPFB-L-2G12-F	10
G3/4	19	32	52.5	36.5	16.5	25	145	547720	NPFB-L-2G34-F	10
G1	24	39	64.5	45	19	30	245	547721	NPFB-L-2G1-F	10

1) Packaging unit quantity

Elbow fitting NPFB-L

Operating pressure:
-0.95 ... +40 bar
Ambient temperature:
-20 ... +150 °C
Operating medium:
Compressed air in accordance with
ISO 8573-1:2010 [7:-:-]

Material:
Nickel-plated brass

Note on material:
Conforms to RoHS

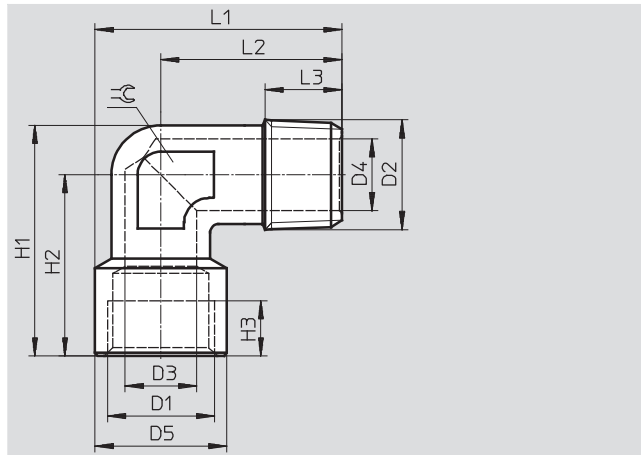

Dimensions and ordering data															
Connection	D3	D4	D5	L1	L2	L3	H1	H2	H3	∠	Weight/piece [g]	Part No.	Type	PU ¹⁾	
D1	D2	∅	∅	∅											
M5	M5	4.2	2	7.5	15.25	11.5	4	17	13.5	4	9	6	547722	NPFB-L-2M5-MF	10
G1/8	R1/8	6	5.5	13	25.5	19	8	25	20	7	10	18	547723	NPFB-L-R18-G18-MF	10
G1/4	R1/4	9	8	16	32	24	12.5	32	25.5	8	13	32	547724	NPFB-L-R14-G14-MF	10
G3/8	R3/8	10	11	20.5	36.75	26.5	13.6	37.5	29	10	17	55	547725	NPFB-L-R38-G38-MF	10
G1/2	R1/2	14	14	25.5	44.25	31.5	15.5	45.5	35	11	20	99	547726	NPFB-L-R12-G12-MF	10
G3/4	R3/4	19	19	32	49	33	16	49.75	36.5	16.5	25	120	547727	NPFB-L-R34-G34-MF	10
G1	R1	24	24	39	58.5	39	17	60.5	45	19	30	212	547728	NPFB-L-R1-G1-MF	10

1) Packaging unit quantity

Threaded fittings NPFB

Technical data



Elbow fitting NPFB-L

Operating pressure:
-0.95 ... +40 bar
Ambient temperature:
-20 ... +150 °C
Operating medium:
Compressed air in accordance with
ISO 8573-1:2010 [7:--:-]

Material:
Nickel-plated brass

Note on material:
Conforms to RoHS

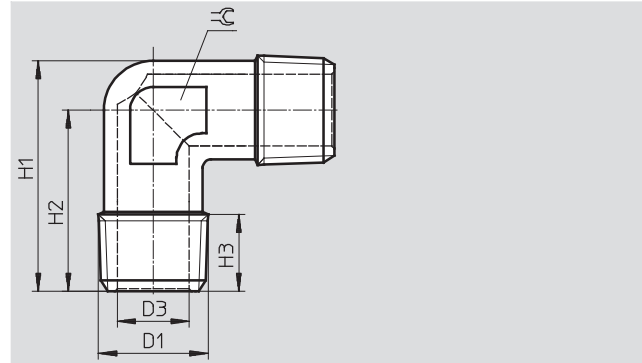

Dimensions and ordering data										
Connection D1	D3 ∅	H1	H2	H3	∅	Weight/piece [g]	Part No.	Type	PU ¹⁾	
M5	2	15.5	11.5	4	9	8	547729	NPFB-L-2M5-M	10	
R1/8	5.5	24	19	8	10	14	547730	NPFB-L-2R18-M	10	
R1/4	8	30.5	24	12.5	13	29	547731	NPFB-L-2R14-M	10	
R3/8	11	34.8	26.5	13.6	17	45	547732	NPFB-L-2R38-M	10	
R1/2	14	42	31.5	15.5	20	83	547733	NPFB-L-2R12-M	10	
R3/4	19	46	33	16	25	100	547734	NPFB-L-2R34-M	10	
R1	24	54.5	39	17	30	174	547735	NPFB-L-2R1-M	10	

1) Packaging unit quantity

T-fitting NPFB-T

Operating pressure:
-0.95 ... +40 bar
Ambient temperature:
-20 ... +150 °C
Operating medium:
Compressed air in accordance with
ISO 8573-1:2010 [7:--:-]

Material:
Nickel-plated brass

Note on material:
Conforms to RoHS

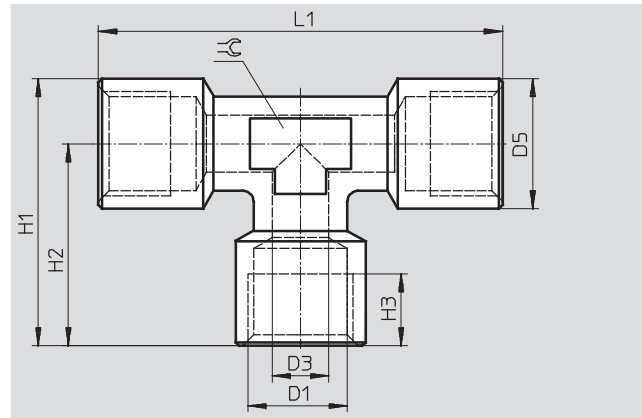

Dimensions and ordering data											
Connection D1	D3 ∅	D5 ∅	L1	H1	H2	H3	∅	Weight/piece [g]	Part No.	Type	PU ¹⁾
M5	4.2	8.5	22	15.25	11	5	9	10	547744	NPFB-T-3M5-F	10
G1/8	6	13	40	26.5	20	7	10	27	547745	NPFB-T-3G18-F	10
G1/4	9	16	51	33.5	25.5	8	13	44	547746	NPFB-T-3G14-F	10
G3/8	10	21	58	39.5	29	10	17	85	547747	NPFB-T-3G38-F	10
G1/2	15	26.2	70	48.1	35	11	20	151	547748	NPFB-T-3G12-F	10
G3/4	19	32	73	52.5	36.5	16.5	25	194	547749	NPFB-T-3G34-F	10
G1	24	39	90	64.5	45	19	30	326	547750	NPFB-T-3G1-F	10

1) Packaging unit quantity

Threaded fittings NPFB

Technical data



T-fitting NPFB-T

Operating pressure:
-0.95 ... +40 bar
Ambient temperature:
-20 ... +150 °C
Operating medium:
Compressed air in accordance with
ISO 8573-1:2010 [7:-:-]

Material:
Nickel-plated brass

Note on material:
Conforms to RoHS

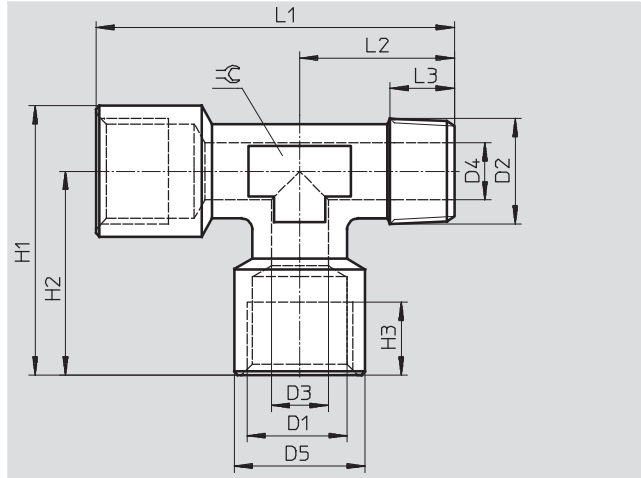

Dimensions and ordering data															
Connection		D3	D4	D5	L1	L2	L3	H1	H2	H3	∅	Weight/piece [g]	Part No.	Type	PU ¹⁾
D1	D2	∅	∅	∅											
M5	M5	4.2	2	8.5	22.5	12	4	15.25	11	5	9	8	547758	NPFB-T-3M5-FMF	10
G ¹ / ₈	R ¹ / ₈	6	5.5	13	39	19	8	26.5	20	7	10	26	547759	NPFB-T-2G18-R18-FMF	10
G ¹ / ₄	R ¹ / ₄	9	8	16	49.5	24	11	33.5	25.5	8	13	46	547760	NPFB-T-2G14-R14-FMF	10
G ³ / ₈	R ³ / ₈	10	11	20.5	55.5	26.5	13.6	39.25	29	10	17	82	547761	NPFB-T-2G38-R38-FMF	10
G ¹ / ₂	R ¹ / ₂	15	15	25.5	66.5	31.5	15.5	47.75	35	11	20	133	547762	NPFB-T-2G12-R12-FMF	10
G ³ / ₄	R ³ / ₄	19	19	32	69.5	33	16	52.5	36.5	16.5	25	172	547763	NPFB-T-2G34-R34-FMF	10
G1	R1	24	24	39	84	39	17.5	64.5	45	19	30	298	547764	NPFB-T-2G1-R1-FMF	10

1) Packaging unit quantity

T-fitting NPFB-T

Operating pressure:
-0.95 ... +40 bar
Ambient temperature:
-20 ... +150 °C
Operating medium:
Compressed air in accordance with
ISO 8573-1:2010 [7:-:-]

Material:
Nickel-plated brass

Note on material:
Conforms to RoHS

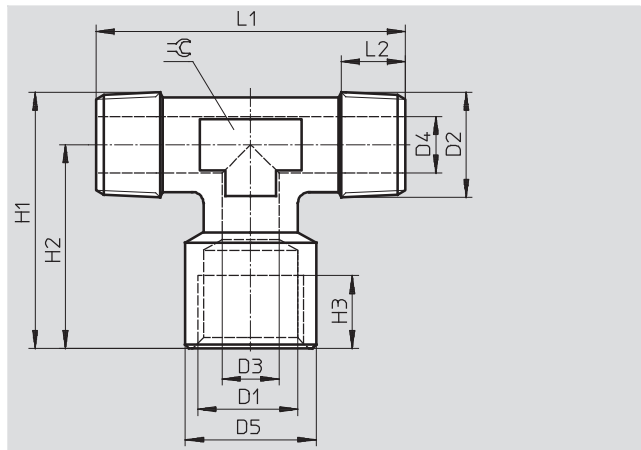

Dimensions and ordering data															
Connection		D3	D4	D5	L1	L2	H1	H2	H3	∅	Weight/piece [g]	Part No.	Type	PU ¹⁾	
D1	D2	∅	∅	∅											
G ¹ / ₈	R ¹ / ₈	5.5	6	13	38	8	24.9	20	7	10	23	547771	NPFB-T-G18-2R18-FMM	10	
G ¹ / ₄	R ¹ / ₄	8	9	16	48	12.5	32	25.5	8	13	43	547772	NPFB-T-G14-2R14-FMM	10	
G ³ / ₈	R ³ / ₈	11	10	20.5	53	13.6	37.5	29	10	17	72	547773	NPFB-T-G38-2R38-FMM	10	
G ¹ / ₂	R ¹ / ₂	15	15	25.5	63	15.5	45.7	35	11	20	118	547774	NPFB-T-G12-2R12-FMM	10	

1) Packaging unit quantity

Threaded fittings NPFB

Technical data



T-fitting NPFB-T

Operating pressure:
-0.95 ... +40 bar
Ambient temperature:
-20 ... +150 °C
Operating medium:
Compressed air in accordance with
ISO 8573-1:2010 [7:--:-]

Material:
Nickel-plated brass

Note on material:
Conforms to RoHS

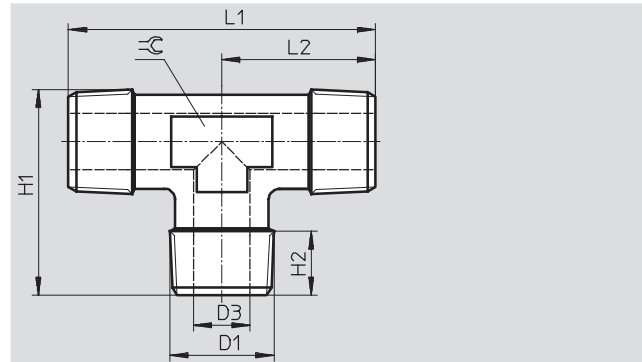

Dimensions and ordering data										
Connection	D3	L1	L2	H1	H2	≅	Weight/piece [g]	Part No.	Type	PU ¹⁾
D1	∅									
R1/8	5.5	38	19	23.9	8	10	20	547765	NPFB-T-3R18-M	10
R1/4	8	48	24	30.6	12.5	13	41	547766	NPFB-T-3R14-M	10
R3/8	11	53	26.5	34.8	13.6	17	62	547767	NPFB-T-3R38-M	10
R1/2	15	63	31.5	42.2	15.5	20	101	547768	NPFB-T-3R12-M	10
R3/4	19	66.4	33.2	45	16.2	25	134	547769	NPFB-T-3R34-M	10
R1	24	78	39	54.2	17.5	30	236	547770	NPFB-T-3R1-M	10

1) Packaging unit quantity

T-fitting NPFB-T

Operating pressure:
-0.95 ... +40 bar
Ambient temperature:
-20 ... +150 °C
Operating medium:
Compressed air in accordance with
ISO 8573-1:2010 [7:--:-]

Material:
Nickel-plated brass

Note on material:
Conforms to RoHS

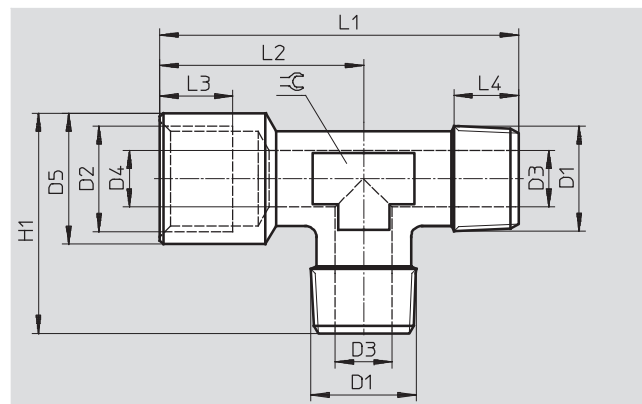

Dimensions and ordering data														
Connection	D3	D4	D5	L1	L2	L3	L4	H1	≅	Weight/piece [g]	Part No.	Type	PU ¹⁾	
D1	D2	∅	∅	∅										
R1/8	G1/8	6	5.5	13	39	20	7	8	25.5	10	24	547775	NPFB-T-2R18-G18-MMF	10
R1/4	G1/4	9	8	16	49.5	25.5	8	12.5	32	13	43	547776	NPFB-T-2R14-G14-MMF	10
R3/8	G3/8	10	11	20.5	55.5	29	10	13.6	36.75	17	72	547777	NPFB-T-2R38-G38-MMF	10
R1/2	G1/2	15	15	25.5	66.5	35	11	15.5	44.25	20	117	547778	NPFB-T-2R12-G12-MMF	10

1) Packaging unit quantity

Threaded fittings NPFB

Technical data



T-fitting NPFB-T

Operating pressure:
-0.95 ... +40 bar
Ambient temperature:
-20 ... +150 °C
Operating medium:
Compressed air in accordance with
ISO 8573-1:2010 [7:--:-]

Material:
Nickel-plated brass

Note on material:
Conforms to RoHS

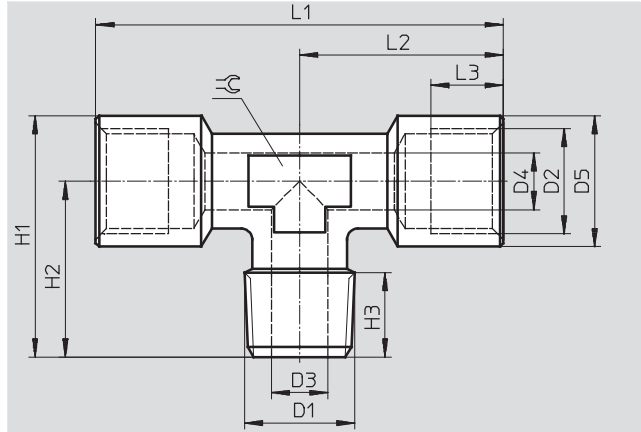

Dimensions and ordering data															
Connection		D3	D4	D5	L1	L2	L3	H1	H2	H3	⌀	Weight/piece [g]	Part No.	Type	PU ¹⁾
D1	D2	∅	∅	∅											
M5	M5	2	4.2	8.5	22	11	5	15.75	11.5	4	9	8	547751	NPFB-T-3M5-MFF	10
R1/8	G1/8	5.5	6	13	40	20	7	25.5	19	8	10	26	547752	NPFB-T-R18-2G18-MFF	10
R1/4	G1/4	8	9	16	51	25.5	8	32	24	12.5	13	46	547753	NPFB-T-R14-2G14-MFF	10
R3/8	G3/8	11	10	20.5	58	29	10	36.75	26.5	13.6	17	83	547754	NPFB-T-R38-2G38-MFF	10
R1/2	G1/2	15	15	25.5	70	35	11	44.25	31.5	15.5	20	130	547755	NPFB-T-R12-2G12-MFF	10
R3/4	G3/4	19	19	32	73	36.5	16.5	49	33	16	25	178	547756	NPFB-T-R34-2G34-MFF	10
R1	G1	24	24	39	90	45	19	58.5	39	17.5	30	296	547757	NPFB-T-R1-2G1-MFF	10

1) Packaging unit quantity

Y-fitting NPFB-Y

Operating pressure:
-0.95 ... +40 bar
Ambient temperature:
-20 ... +150 °C
Operating medium:
Compressed air in accordance with
ISO 8573-1:2010 [7:--:-]

Material:
Nickel-plated brass

Note on material:
Conforms to RoHS

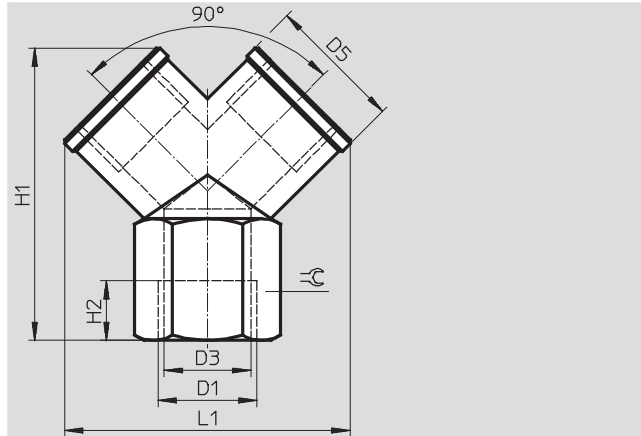

Dimensions and ordering data														
Connection	D3	D5	L1	H1	H2	⌀	Weight/piece [g]	Part No.	Type	PU ¹⁾				
D1	∅	∅												
G1/8	8.7	13	29	26.5	8	13	18	547736	NPFB-Y-3G18-F	10				
G1/4	11.6	17	36	32	11	17	32	547737	NPFB-Y-3G14-F	10				
G3/8	15	21	41	37	11.5	20	44	547738	NPFB-Y-3G38-F	10				
G1/2	19	26	52.5	45	14	25	92	547739	NPFB-Y-3G12-F	10				

1) Packaging unit quantity

Threaded fittings NPFB

Technical data

Y-fitting NPFB-Y

Operating pressure:
-0.95 ... +40 bar
Ambient temperature:
-20 ... +150 °C
Operating medium:
Compressed air in accordance with
ISO 8573-1:2010 [7:--:-]

Material:
Nickel-plated brass

Note on material:
Conforms to RoHS

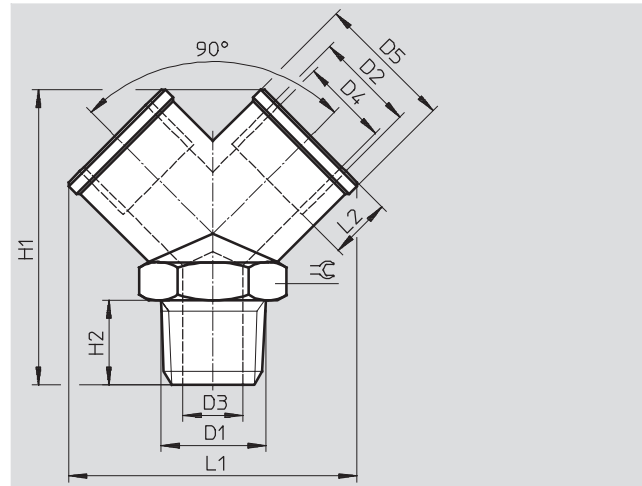

Dimensions and ordering data													
Connection		D3	D4	D5	L1	L2	H1	H2	⌀	Weight/piece	Part No.	Type	PU ¹⁾
D1	D2	Ø	Ø	Ø						[g]			
R1/8	G1/8	5.5	8.7	13	29	8	32	8	13	22	547740	NPFB-Y-R18-2G18-MFF	10
R1/4	G1/4	8	11.6	17	36	11	38	11	17	38	547741	NPFB-Y-R14-2G14-MFF	10
R3/8	G3/8	11	15	21	41	11.5	42.5	11.5	20	52	547742	NPFB-Y-R38-2G38-MFF	10
R1/2	G1/2	15	19	26	52.5	14	53	14	25	110	547743	NPFB-Y-R12-2G12-MFF	10

1) Packaging unit quantity

X-fitting NPFB-X

Operating pressure:
-0.95 ... +40 bar
Ambient temperature:
-20 ... +150 °C
Operating medium:
Compressed air in accordance with
ISO 8573-1:2010 [7:--:-]

Material:
Nickel-plated brass

Note on material:
Conforms to RoHS

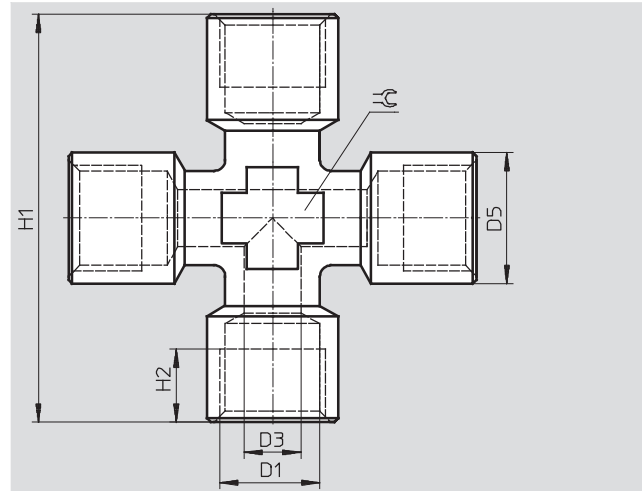

Dimensions and ordering data										
Connection		D3	D5	H1	H2	⌀	Weight/piece	Part No.	Type	PU ¹⁾
D1		Ø	Ø				[g]			
G1/8		6	13	46	7	13	60	547779	NPFB-X-4G18-F	10
G1/4		9	17	51	8	13	73	547780	NPFB-X-4G14-F	10
G3/8		10	20.5	58	10	17	118	547781	NPFB-X-4G38-F	10
G1/2		15	26.2	67	14	21	186	547782	NPFB-X-4G12-F	10

1) Packaging unit quantity

Threaded fittings NPFB

Technical data



X-fitting NPFB-X

Operating pressure:

-0.95 ... +40 bar

Ambient temperature:

-20 ... +150 °C

Operating medium:

Compressed air in accordance with ISO 8573-1:2010 [7:-:-]

Material:

Nickel-plated brass

Note on material:

Conforms to RoHS

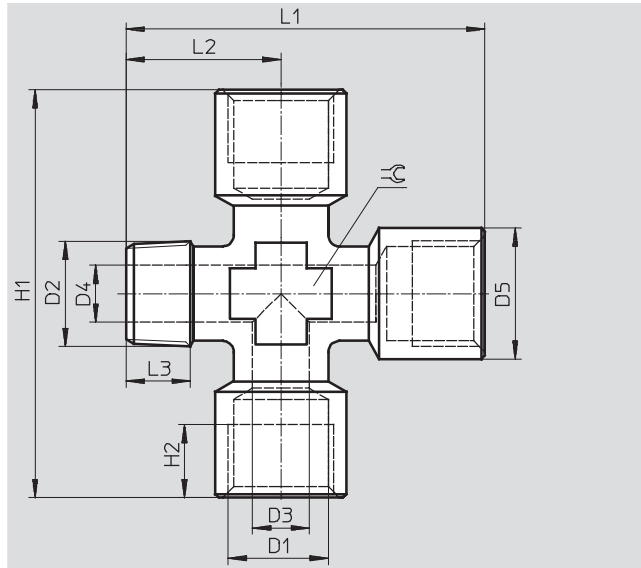

Dimensions and ordering data														
Connection		D3	D4	D5	L1	L2	L3	H1	H2	⌀	Weight/piece [g]	Part No.	Type	PU ¹⁾
D1	D2	∅	∅	∅										
G1/8	R1/8	6	6	13	46	23	8	46	7	13	52	547783	NPFB-X-R18-3G18-MFFF	10
G1/4	R1/4	9	8	17	49.5	24	12.5	51	8	13	67	547784	NPFB-X-R14-3G14-MFFF	10
G3/8	R3/8	10	11	20.5	55.5	26.5	13.6	58	10	17	100	547785	NPFB-X-R38-3G38-MFFF	10
G1/2	R1/2	15	15	26.2	64.5	31	14.0	67	14	21	168	547786	NPFB-X-R12-3G12-MFFF	10

1) Packaging unit quantity

Product Range and Company Overview

A Complete Suite of Automation Services

Our experienced engineers provide complete support at every stage of your development process, including: conceptualization, analysis, engineering, design, assembly, documentation, validation, and production.



Custom Automation Components
Complete custom engineered solutions



Custom Control Cabinets
Comprehensive engineering support and on-site services



Complete Systems
Shipment, stocking and storage services

The Broadest Range of Automation Components

With a comprehensive line of more than 30,000 automation components, Festo is capable of solving the most complex automation requirements.



Electromechanical
Electromechanical actuators, motors, controllers & drives



Pneumatics
Pneumatic linear and rotary actuators, valves, and air supply



PLCs and I/O Devices
PLC's, operator interfaces, sensors and I/O devices

Supporting Advanced Automation... As No One Else Can!

Festo is a leading global manufacturer of pneumatic and electromechanical systems, components and controls for industrial automation, with more than 12,000 employees in 56 national headquarters serving more than 180 countries. For more than 80 years, Festo has continuously elevated the state of manufacturing with innovations and optimized motion control solutions that deliver higher performing, more profitable automated manufacturing and processing equipment. Our dedication to the advancement of automation extends beyond technology to the education and development of current and future automation and robotics designers with simulation tools, teaching programs, and on-site services.

Quality Assurance, ISO 9001 and ISO 14001 Certifications

Festo Corporation is committed to supply all Festo products and services that will meet or exceed our customers' requirements in product quality, delivery, customer service and satisfaction.

To meet this commitment, we strive to ensure a consistent, integrated, and systematic approach to management that will meet or exceed the requirements of the ISO 9001 standard for Quality Management and the ISO 14001 standard for Environmental Management.



© Copyright 2008, Festo Corporation. While every effort is made to ensure that all dimensions and specifications are correct, Festo cannot guarantee that publications are completely free of any error, in particular typing or printing errors. Accordingly, Festo cannot be held responsible for the same. For Liability and Warranty conditions, refer to our "Terms and Conditions of Sale", available from your local Festo office. All rights reserved. No part of this publication may be reproduced, distributed, or transmitted in any form or by any means, electronic, mechanical, photocopying or otherwise, without the prior written permission of Festo. All technical data subject to change according to technical update.



Printed on recycled paper at New Horizon Graphic, Inc., FSC certified as an environmentally friendly printing plant.

Festo North America

Festo Regional Contact Center

5300 Explorer Drive
Mississauga, Ontario L4W 5G4
Canada

USA Customers:

For ordering assistance,

Call: 1.800.99.FESTO (1.800.993.3786)

Fax: 1.800.96.FESTO (1.800.963.3786)

Email: customer.service@us.festo.com

For technical support,

Call: 1.866.GO.FESTO (1.866.463.3786)

Fax: 1.800.96.FESTO (1.800.963.3786)

Email: product.support@us.festo.com

Canadian Customers:

Call: 1.877.GO.FESTO (1.877.463.3786)

Fax: 1.877.FX.FESTO (1.877.393.3786)

Email: festo.canada@ca.festo.com

USA Headquarters

Festo Corporation
395 Moreland Road
P.O. Box 18023
Hauppauge, NY 11788, USA
www.festo.com/us

USA Sales Offices

Appleton

North 922 Tower View Drive, Suite N
Greenville, WI 54942, USA

Boston

120 Presidential Way, Suite 330
Woburn, MA 01801, USA

Chicago

1441 East Business Center Drive
Mt. Prospect, IL 60056, USA

Dallas

1825 Lakeway Drive, Suite 600
Lewisville, TX 75057, USA

Detroit – Automotive Engineering Center

2601 Cambridge Court, Suite 320
Auburn Hills, MI 48326, USA

New York

395 Moreland Road
Hauppauge, NY 11788, USA

Silicon Valley

4935 Southfront Road, Suite F
Livermore, CA 94550, USA

United States



USA Headquarters, East: Festo Corp., 395 Moreland Road, Hauppauge, NY 11788

Phone: 1.631.435.0800; Fax: 1.631.435.8026;

Email: info@festo-usa.com

www.festo.com/us

Canada



Headquarters: Festo Inc., 5300 Explorer Drive, Mississauga, Ontario L4W 5G4

Phone: 1.905.624.9000; Fax: 1.905.624.9001;

Email: festo.canada@ca.festo.com

www.festo.ca

Mexico



Headquarters: Festo Pneumatic, S.A., Av. Ceylán 3, Col. Tequesquahuac,
54020 Tlalneantla, Edo. de México

Phone: 011 52 [55] 53 21 66 00; Fax: 011 52 [55] 53 21 66 65;

Email: festo.mexico@mx.festo.com

www.festo.com/mx

Central USA

Festo Corporation
1441 East Business
Center Drive
Mt. Prospect, IL 60056, USA
Phone: 1.847.759.2600
Fax: 1.847.768.9480



Western USA

Festo Corporation
4935 Southfront Road,
Suite F
Livermore, CA 94550, USA
Phone: 1.925.371.1099
Fax: 1.925.245.1286



Festo Worldwide

Argentina Australia Austria Belarus Belgium Brazil Bulgaria Canada Chile China Colombia Croatia Czech Republic Denmark
Estonia Finland France Germany Great Britain Greece Hong Kong Hungary India Indonesia Iran Ireland Israel Italy Japan Latvia
Lithuania Malaysia Mexico Netherlands New Zealand Norway Peru Philippines Poland Romania Russia Serbia Singapore
Slovakia Slovenia South Africa South Korea Spain Sweden Switzerland Taiwan Thailand Turkey Ukraine United States Venezuela

www.festo.com



Artisan Technology Group is your source for quality new and certified-used/pre-owned equipment

- FAST SHIPPING AND DELIVERY
- TENS OF THOUSANDS OF IN-STOCK ITEMS
- EQUIPMENT DEMOS
- HUNDREDS OF MANUFACTURERS SUPPORTED
- LEASING/MONTHLY RENTALS
- ITAR CERTIFIED SECURE ASSET SOLUTIONS

SERVICE CENTER REPAIRS

Experienced engineers and technicians on staff at our full-service, in-house repair center

*InstraView*SM REMOTE INSPECTION

Remotely inspect equipment before purchasing with our interactive website at www.instraview.com ↗

WE BUY USED EQUIPMENT

Sell your excess, underutilized, and idle used equipment. We also offer credit for buy-backs and trade-ins. www.artisanng.com/WeBuyEquipment ↗

LOOKING FOR MORE INFORMATION?

Visit us on the web at www.artisanng.com ↗ for more information on price quotations, drivers, technical specifications, manuals, and documentation

Contact us: (888) 88-SOURCE | sales@artisanng.com | www.artisanng.com