



## Artisan Technology Group is your source for quality new and certified-used/pre-owned equipment

- FAST SHIPPING AND DELIVERY
- TENS OF THOUSANDS OF IN-STOCK ITEMS
- EQUIPMENT DEMOS
- HUNDREDS OF MANUFACTURERS SUPPORTED
- LEASING/MONTHLY RENTALS
- ITAR CERTIFIED SECURE ASSET SOLUTIONS

### SERVICE CENTER REPAIRS

Experienced engineers and technicians on staff at our full-service, in-house repair center

### *InstraView*<sup>SM</sup> REMOTE INSPECTION

Remotely inspect equipment before purchasing with our interactive website at [www.instraview.com](http://www.instraview.com) ↗

### WE BUY USED EQUIPMENT

Sell your excess, underutilized, and idle used equipment. We also offer credit for buy-backs and trade-ins. [www.artisanng.com/WeBuyEquipment](http://www.artisanng.com/WeBuyEquipment) ↗

### LOOKING FOR MORE INFORMATION?

Visit us on the web at [www.artisanng.com](http://www.artisanng.com) ↗ for more information on price quotations, drivers, technical specifications, manuals, and documentation

**Contact us:** (888) 88-SOURCE | [sales@artisanng.com](mailto:sales@artisanng.com) | [www.artisanng.com](http://www.artisanng.com)



# **Instruction Manual**

## **FVR-C9S-2UX Drive Series**

### *Three-phase 230 VAC Input Type*



**CAUTION**

- Make sure that you read this instruction manual thoroughly before installing, wiring, operating and inspecting this drive.
- Please make sure that this instruction manual accompanies the drive to the end user.
- Keep this instruction manual so that it will always be available for the duration of the drive's operating life.
- Product specifications are subject to change without notice.

# FVR-C9S-2UX

Thank you for purchasing the Fuji “FVR-C9S” drive, marketed by GE Fuji Drives USA, Inc. This instruction manual is included with the drive and equipment and is provided for the convenience of the end user. Please be sure it accompanies the drive.

## CONTENTS

0.	Safety Precautions .....	4
1.	Inspection Upon Receipt .....	6
2.	Part Names .....	7
3.	Warning and Caution .....	7
4.	Specifications .....	8
5.	External Dimensions .....	10
6.	Installation Instructions .....	13
7.	Wiring .....	13
8.	Basic Wiring Diagrams .....	15
9.	Application of Wiring and Equipment .....	17
10.	Terminal Function Explanation .....	18
11.	Operation .....	20
12.	Keypad Panel .....	22
13.	Function Explanation .....	24
14.	Protective Functions .....	35
15.	Warranty Parts and Service .....	36

## 0. Safety Precautions

Before carrying out installation, wiring, maintenance or inspection of the drive, read this instruction manual thoroughly to gain a full understanding of the correct operation procedures. Make sure that you have read all product details, safety information, warnings and cautions before use. The following classifications for warnings and cautions are used throughout this manual.

### **WARNING:**

Denotes operating procedures and practices that may result in severe injury or loss of life if not correctly followed.

### **CAUTION:**

Denotes operating procedures and practices that, if not strictly observed, may result in personal injury or damage to the equipment.

### **WARNING:**

#### **FIRE AND PERSONAL INJURY HAZARD**

This drive is designed for variable-speed operation of three-phase induction motors. It cannot be used with single-phase motors or for any other applications, otherwise fire may result.

The drive cannot be used by itself for elevators, life-preservation equipment or other equipment which is directly related to human safety. In such situations, sufficient consideration should be given to overall system configuration, not just to the drive, otherwise serious accidents could result.

## **INSTALLATION**

### **WARNING:**

#### **FIRE AND PERSONAL INJURY HAZARD**

Install the drive to a non-flammable surface such as a metal surface, otherwise fires may result.

Do not place the drive near flammable materials, otherwise fires may result.

Do not hold the drive by its cover when transporting. The drive could be damaged and cause injury to personnel.

Do not let any scraps of thread, paper, sawdust, dirt, metal shavings or other foreign objects get inside the drive or onto the cooling fins, otherwise fire or problems with operation may result.

Do not install and operate the drive if it is damaged or if some of the parts are missing. Doing so may result in severe personal injury.

Do not touch the drive cooling fin because the cooling fin reaches high temperatures during operation, otherwise personal injury may result.

## **WIRING**

### **WARNING:**

#### **FIRE AND ELECTRIC SHOCK HAZARD.**

When connecting the drive to a power supply, be sure to connect it via a circuit breaker, a leakage current breaker or a fuse, otherwise fires may result.

AC input fuses are required to validate the UL listing of this device.

Use only fuses and circuit breakers with rated capacities that are suitable for use with the drive. Failure to do so may result in fire.

Connect the drive with a secure ground, otherwise electric shocks or fires may result.

Wiring work should only be carried out by suitably qualified personnel, otherwise electric shocks may result.

Make absolutely sure that the power supply is turned off (open) before wiring, otherwise electric shocks may result.

Wiring work should only be carried out after the drive has been installed, otherwise electric shocks or injury may result.

## **CAUTION:**

Check that the phase and voltage of the AC power supply being connected matches the input phase and rated input voltage of the drive. Using an improper power supply may cause injury or damage to the equipment.

Do not connect AC power to the output terminals (U, V, W) otherwise injury may result.

The drive, motor and wiring produce electromagnetic noise during operation. Make sure that this does not interfere with the operation of sensors or other equipment nearby, otherwise accidents may result.

## **OPERATION**

### **WARNING:**

#### **ELECTRIC SHOCK HAZARD**

Always install the drive cover before turning on the power supply. In addition, do not remove the drive cover while the power is on. Failure to observe these precautions may result in electric shocks.

Do not operate any of the switches with wet hands, otherwise electric shocks may result.

### **WARNING:**

#### **FIRE AND PERSONAL INJURY HAZARD**

If the retry function has been activated and a trip occurs, the drive will restart automatically depending on the cause of the trip. Make sure that the system is set up properly so that there will be no danger to personnel when the drive starts.

The STOP key is only effective when keypad panel operation has been selected in the function settings. A separate switch should be installed for emergency stopping purposes.

If an alarm reset is carried out while a run signal (FWD/REV) is being input, the drive will suddenly restart. Always check that the run signal is not being input before carrying out the alarm reset, otherwise accidents may occur.

Never touch the drive terminals while the power is fed to the drive, regardless of whether the drive is running or not.

## **CAUTION:**

Do not touch the cooling fins, as they become hot during drive operation.

Because it is relatively easy to set the drive to high speed operation, be sure to check the capacity of the motor and the equipment being operated before changing the drive function setting.

The drive braking function cannot be substituted for mechanical means. Attempting to do so may result in injury.

## **MAINTENANCE, INSPECTION AND PART REPLACEMENT**

### **WARNING:**

#### **ELECTRIC SHOCK HAZARD**

Wait at least five minutes after turning off the power before carrying out inspection. Check that the charge indication lamp has gone out. Do not touch the drive parts if the lamp is still lit, otherwise electric shocks may result.

Maintenance, inspection and parts replacement should only be carried out by suitably qualified personnel. Remove any metallic accessories such as watches and rings before starting work, and use only properly insulated tools, otherwise electric shocks may result.

## **DISPOSAL**

### **CAUTION**

Disposal of the drive should be entrusted to a suitably-qualified disposal agency, otherwise injury may result.

## **PACKING**

### **CAUTION**

Do not stand or sit on the drive as injury may result.

The number of packing cartons that can be stacked together is printed on the packing container. Do not stack the containers any higher than this or injury may result.

# FVR-C9S-2UX

## UL/CSA

### **WARNING / AVERTISSEMENT**

Hazard of electrical shock. Disconnect incoming power before working on this control.

Risque de choc électrique. Couper l'alimentation avant le dépannage de cette commande.

More than one live circuit. See diagram. Cet équipement renferme plusieurs circuits sous tension. Voir le schéma

### **CAUTION ATTENTION**

Dangerous voltage exists until charge light is off. Prede tensions dangereuses tant que le voyant n'est pas éteint.

Suitable for use on a circuit capable of delivering not more than 5,000 rms symmetrical amperes. 240V maximum.

- Use 60/75° C copper wire only.
- Use Class 1 wire only.
- Open type equipment
- Tightening torque and wire range for field wiring terminals are as follows:

Model	Required torque (N.m)	Wire range
FVRF12C9S-2UX	0.98	14
FVRF25C9S-2UX	0.98	14
FVRF50C9S-2UX	0.98	14
FVR001C9S-2UX	0.98	14
FVR002C9S-2UX	0.98	14
FVR003C9S-2UX	0.98	14
FVR005C9S-2UX	1.777	12
Control board terminal	0.7	24

Use the listed quick-acting fuse in series. Factory recommendation is a Bussman type, JKS or equivalent. Fuses are required to validate the UL and CSA listings.

Model	Dist. fuse size, 600V
FVRF12C9S-2UX	5
FVRF25C9S-2UX	5
FVRF50C9S-2UX	5
FVR001C9S-2UX	10
FVR002C9S-2UX	20
FVR003C9S-2UX	20
FVR005C9S-2UX	30

Field wiring connection shall be made by a UL listed and CSA Certified closed-loop terminal connector sized for the wire gauge involved. Connector must be fixed using the crimp tool specified by the connector manufacturer.

## OTHER

### **WARNING:**

#### **FIRE AND PERSONAL INJURY HAZARD**

Do not carry out any modifications to the drive. Doing so may result in electric shock and injury.

### **GENERAL CAUTION**

All of the illustrations in this instruction manual show the drive with the covers and other protective equipment removed in order to facilitate explanation of detailed parts of the drive. Be absolutely sure to return all covers and protective equipment to the prescribed positions before operating the drive, and make sure that all operations are carried out in accordance with the instructions in this manual.

## **1. Inspection Upon Receipt**

Please inspect the following items upon receipt of your drive.

- Check the name plate to insure the specifications correspond to those ordered.
- Inspect the unit for damage which may have occurred during shipping.

If you have any problems or questions regarding the drive, please contact the nearest Fuji sales office or the distributor where the unit was purchased.

## **Nameplate**

<b>FUJI</b> ELECTRIC		
TYPE	FVRF 12C9S-2UX	← 1
SOURCE	3PH 200-230V 0.9A 50/60 HZ	← 2 3 4
OUTPUT	3PH 200-230 0.7A 1/8HP 1-120HZ	← 5 6 7
SER. NO.		← 8
Fuji Electric Co. Inc. Japan		

## 1. Type

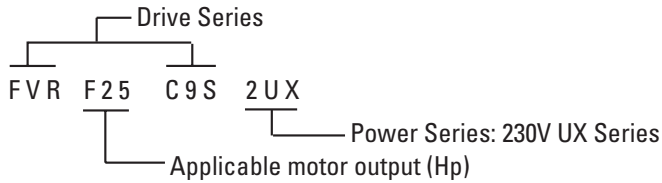

2. Phase: 3PH - three-phase

3. Voltage range: 200V - 230V - AC200V Series

4. Frequency: 50/60Hz

5. Rated output capacity

6. Rated output current

7. Output frequency range: 1- 120 Hz

8. Serial No.

## 2. Part Names

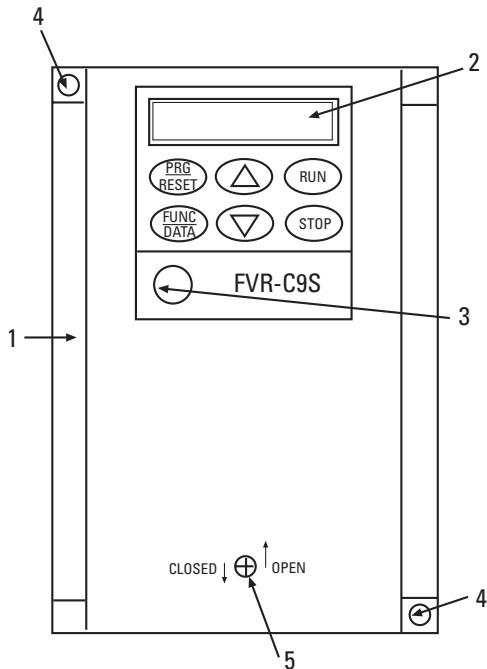

1. Drive Cover

2. Keypad Panel

3. Frequency Setting VR

4. Mounting Screw Holes

5. Drive Cover Screw

## 3. Warning and Caution

Improper wiring will result in damage to, and failure of the unit. Please carefully note the items listed below, and use the unit as indicated.

### **WARNING AND CAUTION**

1. Do not impress power supply voltage that exceeds the standard specification voltage permissible fluctuation. (Permissible voltage: AC200V - 230V)
2. Do not connect power supply to the drive output terminals (U, V, W). Connect power supply only to the power terminals (L1, L2 and L3)
3. Whenever removing the drive cover, always switch off the power supply. Do not switch on the power supply to the drive with the drive cover removed.
4. Do not touch the live part until the CRG lamp located above the main circuit terminals goes out.
5. Avoid using a magnetic contactor (ON/OFF) installed in the line side of the drive for RUN and STOP. Use the FWD-CM (forward) and REV-CM (reverse) terminals for RUN and STOP.
6. Do not connect a power factor correcting capacitor to the output side of the drive.
7. Do not perform a megger test between the drive terminals or on the control circuit terminals.



## 4. Specifications

Type (FVR ___ C9S-2UX)		F12	F25	F50	001	002	003	005	
Applicable motor output <sup>1</sup>		[Hp]	1/8	1/4	1/2	1	2	3	5
Output Rating	Rated capacity <sup>2</sup>	[kVA]	0.28	0.56	1.0	1.6	2.8	4.0	6.6
	Voltage	[V]	Three-phase 200-230V 50/60 Hz (Output voltage is proportional to input voltage)						
	Rated current	[A]	0.7	1.4	2.5	4.0	7.0	10.0	16.5
	Overload current rating		150% 1 min.						
	Rated frequency	[Hz]	50/60 Hz						
Input power supply	Phase, voltage, frequency		Three-phase 200-230V 50/60 Hz						
	Allowable variation in voltage/frequency		Voltage: =10 - 15% Frequency: 15% (Imbalance in power supply voltage: 3%)						
	Instantaneous voltage drop withstanding capacity		Drive is kept running if voltage is 165V or more. If voltage drops more than 165V from rated voltage, drive is run for 15ms. <sup>3</sup>						
	Required power supply capacity	[kVA]	0.3	0.7	1.2	1.8	3.2	4.5	7.3
Output frequency	Adjustment	Max. freq. <sup>4</sup>	[Hz]	50-120 Hz Setting variable (in increments of 1 Hz)					
		Base freq.	[Hz]	50-120 Hz Setting variable (in increments of 1 Hz)					
		Starting freq.	[Hz]	1-6 Hz Setting variable (in increments of 1 Hz)					
	Accuracy		Analog setting: ±1.0% of max. frequency (25±10°C) Digital setting: ±0.01% of max. frequency (-10 - +50°C)						
	Setting resolution		Analog setting: 1/255 of max. frequency (ex. 0.25 Hz / 60 Hz, 0.5 Hz / 120 Hz) Digital Setting: 0.1 Hz (99.9 Hz max) 1 Hz (100-120 Hz)						
Control	Control method		Sine wave PWM control (Extremely low noise by high frequency carrier)						
	Operation		Keypad operation: Operation control by RUN/STOP keys Terminal strip: Forward command. Reverse command. Coast-to-stop command. Reset. External alarm.						

C92-2-13

1) "Applicable motor" indicates a standard 4-pole motor.

2) "Rated capacity" indicates a capacity at 230V rating.

3) This applies to the case where momentary power failure occurs under such conditions that rated voltage is inputted and load factor is 85%.

4) Shows the case where an applicable motor equipped with an AC reactor (option) on the input side is used.

# FVR-C9S-2UX

Type (FVR _ _ _ C9S-2UX)		F12	F25	F50	001	002	003	005
Applicable motor output <sup>1</sup> [Hp]		1/8	1/4	1/2	1	2	3	5
Control	Frequency setting	Key operation: Setting with UP/DOWN keys Potentiometer: Terminal for 1-5K ohm VR is provided Analog signal: 0-5 VDC 0-10 VDC (input resistance = 22k ohm)						
	Display Run mode Fault mode Other	Output frequency is displayed. (3 digit LED) Cause of fault is displayed. LED comes on with charging voltage applied.						
	Acceleration/Deceleration time	0-60s (Variable setting) Acceleration time and deceleration time can be set independently.						
	Voltage frequency characteristics	Setting of maximum frequency/base frequency is variable.						
	Restart after momentary power failure	"Automatic restart" setting makes it possible to keep motor running and restart drive in case of a momentary power failure.						
	High Limiter & Low Limiter	Upper limit and lower limit of frequency can be set.						
	Bias setting	Bias setting is possible with respect to analog frequency setting.						
	Jump frequency	Three jump points and one jump width can be set.						
	Torque boost	Setting variable in 32 steps.						
	Starting torque [%]	150% for 60 seconds						
Braking	Braking torque <sup>5</sup> [%]	150% 1 min.	100% 1 min.	50% 1 min.	30% 1 min.			
	DC brake	Brake starting frequency: 3 Hz (fixed) Setting of braking current / braking time is variable.						
Protection	Overload	Detects overload current and stops drive.						
	Momentary overcurrent	Protects drive in case of ground fault (detects at start) and short circuit of output circuit.						
	Overvoltage	Detects overvoltage of DC bus and stops drive.						
	Overheating of cooling element	Detects abnormal temp. rise of cooling element and stops drive.						
	Motor protection	Protects standard 4-pole motor and forced-air cooled motor by means of electronic thermal overload relay.						
	Alarm protection	Outputs contact signal in case of a trip for protection (1c contact capacity: AC250V 0.3A cos = 0.3)						
Environment	Installation location	Indoor at an altitude of 3283 feet (1000m) or less and free of dust, corrosive gas and oil mist.						
	Ambient temperature	-10 to 65°C						
	Ambient humidity	20 -90% RH (There shall be no dew condensation)						
	Vibration	19 feet/s <sup>2</sup> (5.9m/s <sup>2</sup> ) or less Vibration frequency: 5 - 55 Hz						
	Storage temperature	-25 to 65°C						
	Atmospheric pressure	Operation/storage: min 900 mb (equivalent to 3283 feet (1000m)) Transport: min 660 mb (equivalent to 10720 feet (3265m))						
	Enclosure	IP20						
Cooling method		Self-cooling			Forced-air cooling			

5) This indicates average braking torque of a single motor. (Value varies according to motor efficiency.)

### 5. External Dimensions

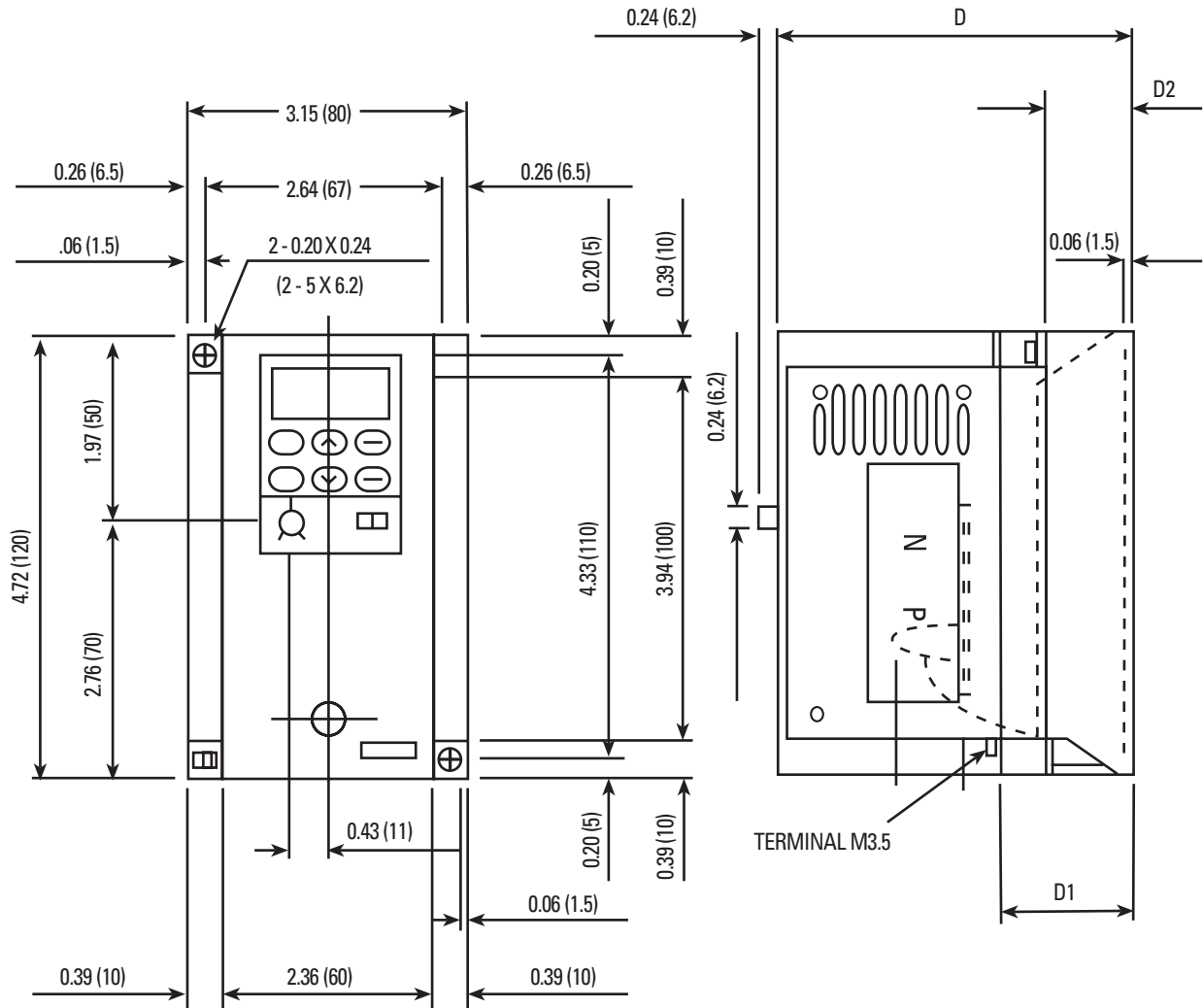

DWG 1: FVRF12C9S-2UX to FVR001C9S-2UX

Type	Rated Current [A]	External Dimensions: inches (mm)			DWG No.
		D	D1	D2	
FVRF12C9S-2UX	0.7	2.38 (60.5)	0.89 (22.5)	0.39 (10)	DWG 1
FVRF25C9S-2UX	1.4	2.58 (65.5)	1.08 (27.5)	0.59 (15)	
FVRF50C9S-2UX	2.5	2.97 (75.5)	1.48 (37.5)	0.98 (25)	
FVR001C9S-2UX	4.0	3.96 (100.5)	2.46 (62.5)	1.97 (50)	

# FVR-C9S-2UX

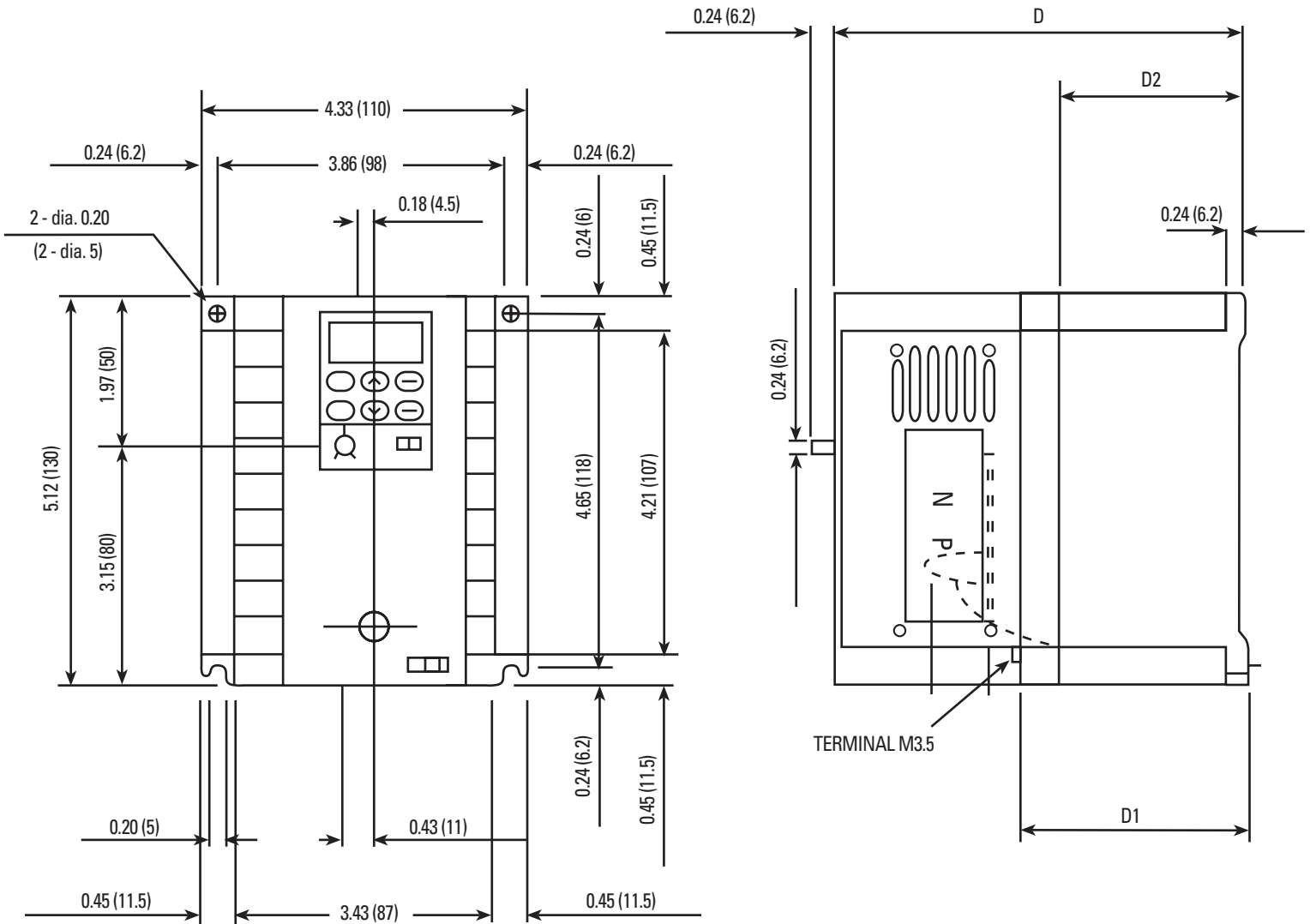

DWG 2: FVR002C9S to FVR003C9S-2UX

Type	Rated Current [A]	External Dimensions: inches (mm)			DWG No.
		D	D1	D2	
FVR002C9S-2UX	7.0	5.14 (130.5)	3.05 (77.5)	2.56 (65)	DWG 2
FVR003C9S-2UX	10.0	5.53 (140.5)	3.05 (77.5)	2.56 (65)	

2-005

**External Dimensions cont.**

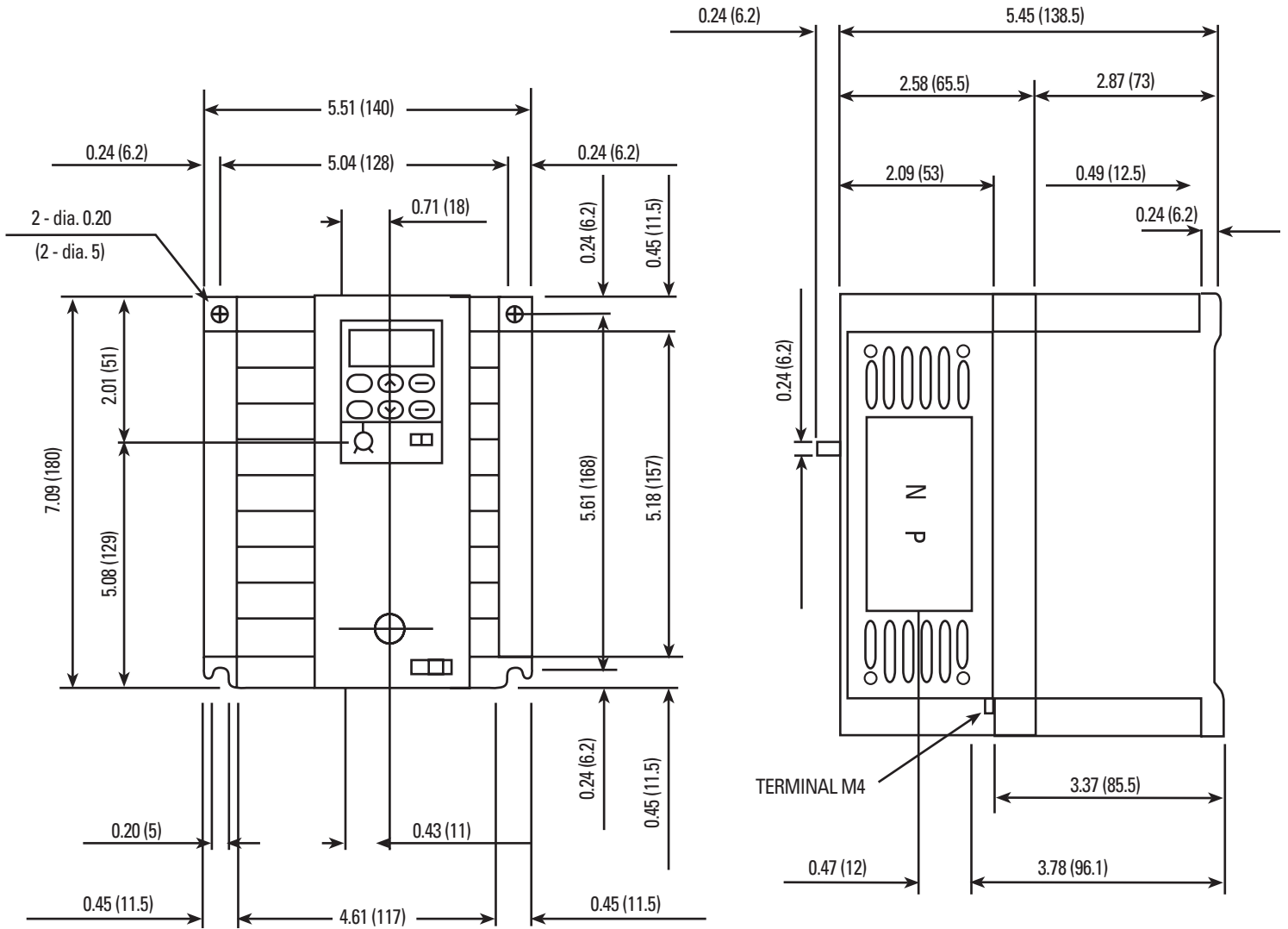

FVR005C9S-2UX

## 6. Installation Instructions

### Installation Conditions

Install the drive in a location which meets the following requirements:

- The ambient temperature should be between  $-10^{\circ}\text{C}$  and  $+50^{\circ}\text{C}$ .
- The humidity should be between 20 and 90% RH. Avoid any location subject to dew condensation, freezing or where the drive could come into contact with any liquids.
- Do not install in any location subject to any of the following conditions: direct sunlight, dust, corrosive gas, inflammable gas or oil mist.
- The drive should be installed at an elevation below 3283 feet (1000m), and vibration should be less than 232 inches/s<sup>2</sup> (5.9m/s<sup>2</sup>)

### Mounting Direction and Space

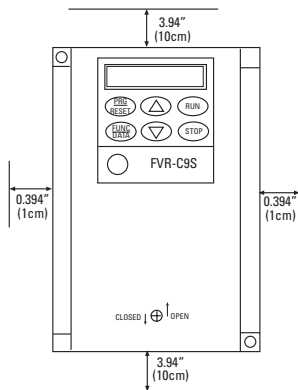

**NOTICE:** The durability and reliability of the drive will be affected by the ambient temperature. Do not place the unit where ambient temperature is not proper.

**Direction:** Insert M4 size screws in the mounting screw holes in the left upper and right lower of the drive, and install the drive with these screws. Install the drive vertically. Horizontal or other positional installation will cause the drive to overheat.

**Space:** The drive will generate heat during operation. Allow sufficient space around the unit as shown in the above figure.

**Mounting plate:** Heat sink temperature will reach  $+90^{\circ}\text{C}$  during operation. Please use thermostable material for drive mounting plate.

**Multi-mounting:** When 2 or more drives are installed within the drive switchboard, arrange them side by side, keeping space (shown in the above figure) between each drive. If the drives must be lined up vertically, provide adequate ventilation so that the hot air from each drive will not affect the one above it.

## 7 Wiring

Perform wiring in accordance with the following procedure:

- 1) Remove the cover mounting screw at the center of the cover.

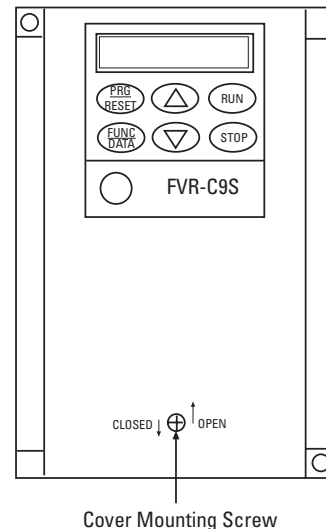

- 2) Hold the lower end of the cover, lift it up and remove the cover

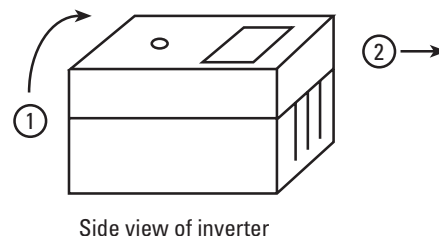

- 3) Remove the keypad panel from the main unit, and disconnect the harness from the CN2 at the same time.

# FVR-C9S-2UX

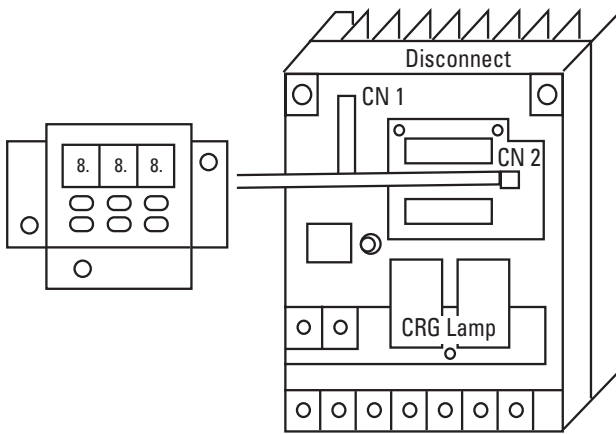

4) Arrange the main circuit and the control circuit wiring as follows.

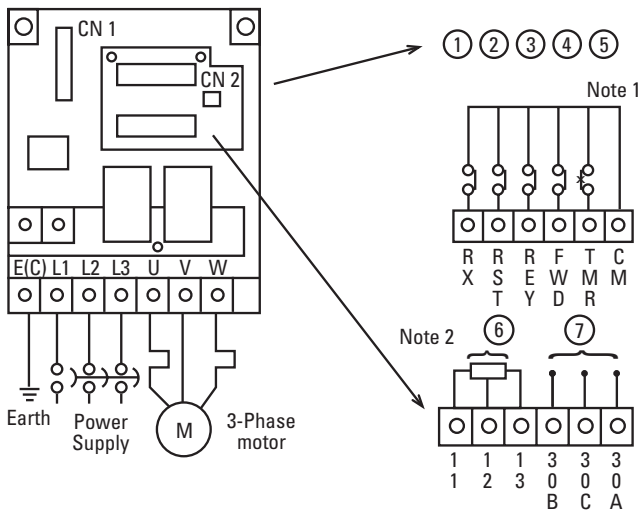

1. Motor coast-to-stop
2. Reset signal
3. Reverse-direction operation command
4. Forward-direction operation command
5. External alarm
6. Frequency setting VR
7. Combined alarm relay output

Note 1) FWD and THR are connected to CM at the factory. In this condition, starting/stopping can be performed via RUN/STOP keys on the keypad panel.

Note 2) In case of using an external potentiometer, remove the connector by which the keypad panel and the CN2 on the drive main unit are connected.

5) Reinstall the cover. Connect the harness of the keypad panel to the CN2 on the main unit, then reinstall the keypad panel fitting it onto the guide pins.

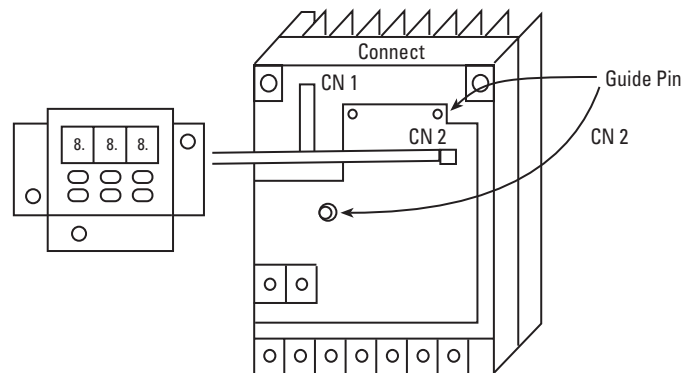

6) As shown below, reinstall the cover onto the drive main unit, and fix it with the mounting screw.

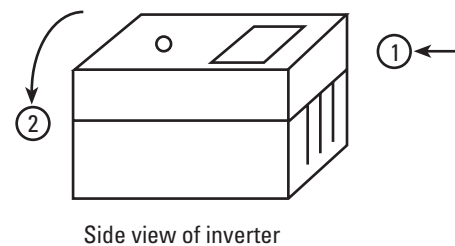

Side view of inverter

## 8. Basic Wiring Diagrams

### 1) Keypad Panel Operation

From the factory, the drive is set for frequency control by means of the potentiometer control knob on the keypad panel. The RUN/STOP function of the drive is controlled by the RUN/STOP keys on the keypad panel.

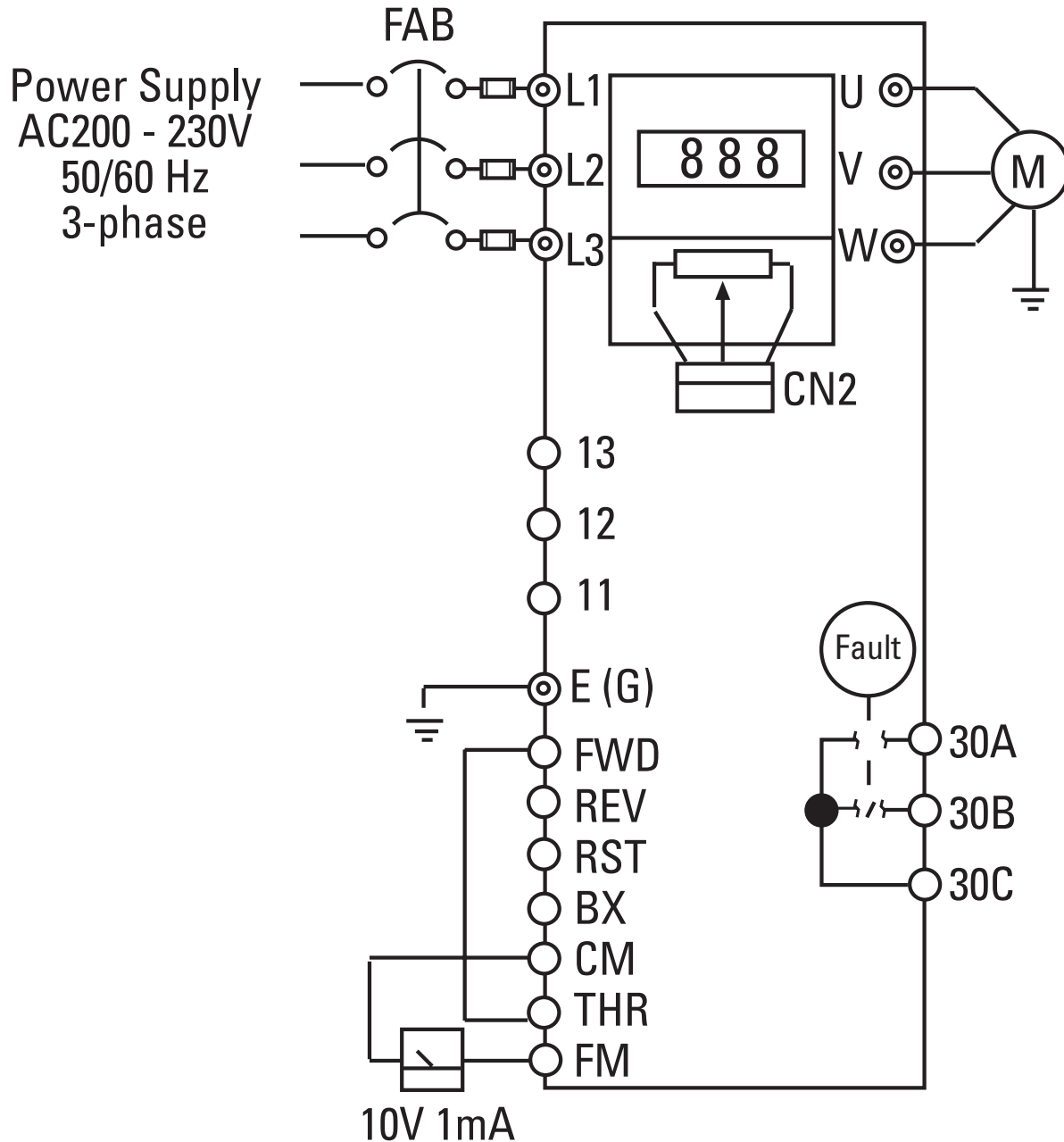



## 2) External Signal Operation

Ensure that the connection is as shown below when operating the drive by means of an external frequency setting potentiometer or contact signal.

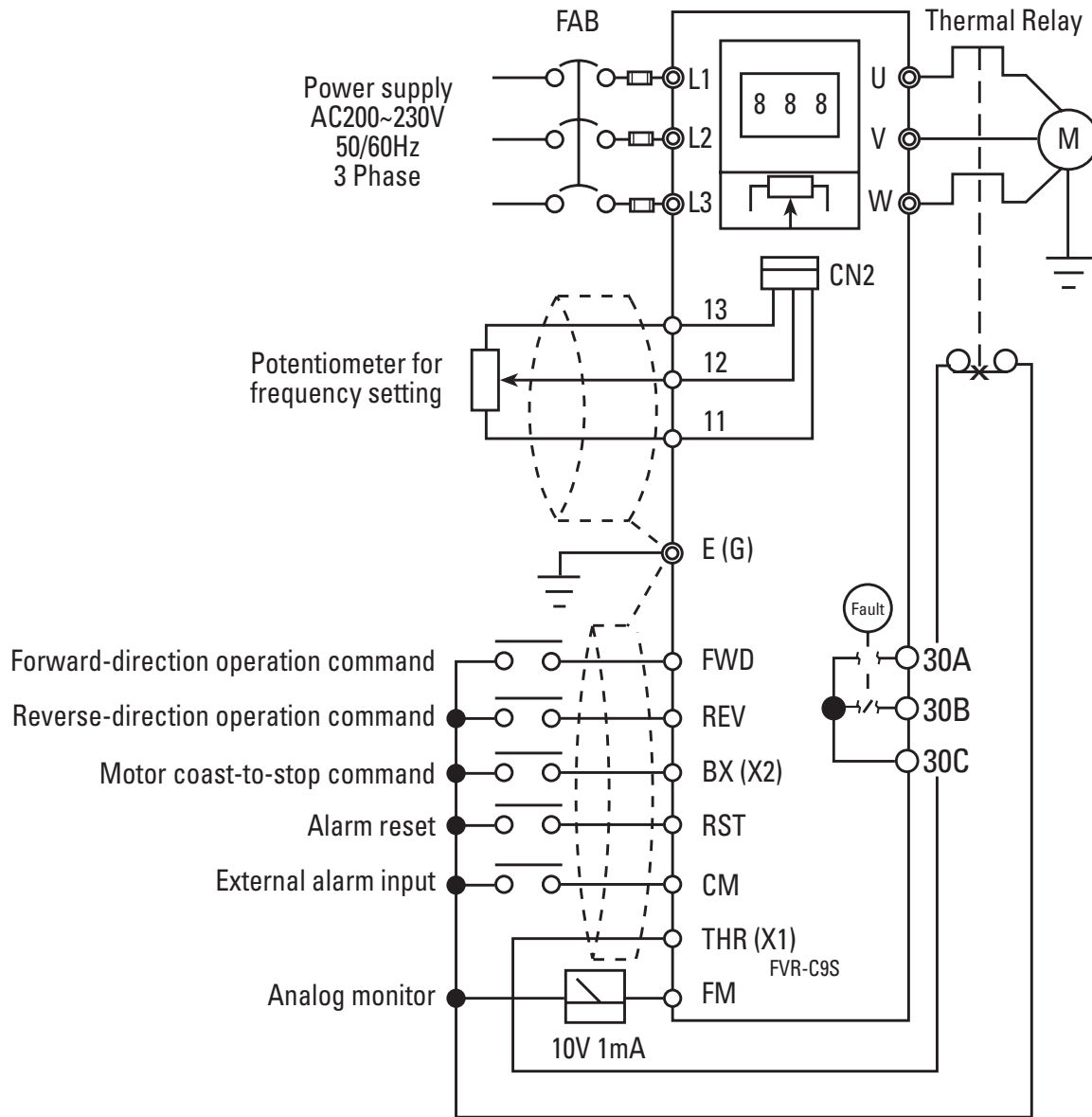

Note 1) Set function F02 to 1.

Note 2) In case of using an external frequency setting potentiometer, disconnect the potentiometer connector (CN2) from the keypad panel. Use of an external potentiometer together with the potentiometer on the keypad panel may result in damage to the drive.

# FVR-C9S-2UX

## **CAUTION:**

The control circuit terminal wiring should be kept as far as possible from the main circuit wiring to prevent operational error due to noise interference. Never install them in the same duct or conduit. (A separation distance of 4 inches [10cm] or more is recommended.) If the control circuit wiring must cross the main circuit wiring, make sure it crosses at a right angle.

Use shielded, twisted wire for the control circuit wiring, which should be as short as possible (65 feet [20m] or less).

Install a surge absorber in parallel with any magnet contactors, solenoids, relays or timer coils, which are close to the drive.

Long wire lengths between the motor and the drive will result in increased capacitance and leakage current. This may cause earlier activation of such protective function as overcurrent protection, overheating protection and electronic thermal overload, or the error in current detection may become large. To avoid these, adjust the length of wiring between the drive and the motor so that it does not exceed the length shown below.

FVRF12C9S-2UX : 165 feet (50m)

FVRF25 to 005C9S-2UX : 325 feet (100m)

## **9. Application of Wiring and Equipment**

Applicable motor output [Hp]		1/8	1/4	1/2	1	2	3	5
Drive type		FVRF12 C9S-2UX	FVRF25 C9S-2UX	FVRF50 C9S-2UX	FVRF001 C9S-2UX	FVRF002 C9S-2UX	FVRF003 C9S-2UX	FVRF005 C9S-2UX
Output rated capacity [kVA]		0.28	0.56	1.0	1.6	2.8	4.0	6.6
Applicable wire size (AWG)	Main circuit	14						12
	Control circuit	24						
MCCB		15				20	30	
ELCB		15				20	30	
Listed fuse*		5		10	20	30		

\* The use of quick-acting fuses is required to validate UL listings. The factory recommendation is Bussman type JKS or equivalent.

C92-2-15

## 10. Terminal Function Explanation

### Terminal Function Explanation

Classification	Terminal Code	Terminal Name	Explanation of Function
Main Circuit	L1, L2, L3	Commercial power supply input terminals	For connection of 3-Phase 200 to 230V commercial power supply
	U, V, W	Drive Output Terminals	For connection of a 3-Phase motor
	E (G)	Drive Grounding Terminals	Grounding terminal of drive chassis (case). Be sure to ground the drive to prevent electric shock or to lower noise
Frequency Setting	13	Power Supply for Frequency Setting	Used as a power supply for frequency setter (variable resistor: 1 - 5K ohm) (DC + 10V, 10mA max)
	12	Frequency Setting Voltage Input	DC 0 - +10V / 0 - 100% (Input resistance: 22K ohm)
	11*	Frequency Setting Common Terminal	Common terminal for frequency setting signals 12 and 13
Control Input	FWD	Forward/Stop Command Input Terminal	Forward-direction operation takes place when FWD-CM is closed. Drive decelerates and stops when FWD-CM is opened
	REV	Reverse/Stop Command Input Terminal	Reverse-direction operation takes place when REV-CM is closed. Drive decelerates and stops when REV-CM is opened
	BX	Motor Coast-to-Stop Input Terminal	<ul style="list-style-type: none"> <li>• Drive output is cut off instantly and motor will coast-to-stop when BX-CM is closed. Alarm signal is not outputted.</li> <li>• This functions as multistep frequency selection terminal X2 when changing function.</li> </ul>
	THR	External Alarm Input Terminal	<ul style="list-style-type: none"> <li>• When THR-CM is opened during operation, drive output is cut (motor will coast-to-stop) and an alarm signal is outputted. This signal is latched and reset by RST input.</li> <li>• This functions as multistep frequency selection terminal X1 when changing functions.</li> </ul>
	RST	Alarm Reset Terminal	When RST-CM is closed, the drive fault is reset.
	CM*	Control Input Common Terminal	Common terminal for control input signals

C92-03

\* Electric potential of 11 terminal is identical with that of CM terminal.

# FVR-C9S-2UX

## Terminal Function Explanation

Classification	Terminal Code	Terminal Name	Explanation of Function
Output for Motor	FM	Analog Monitor	<p>Outputs + 10VDC between FM and CM terminals. When frequency setting is equal to the maximum frequency setting, outputs + 10VDC at 150% current when monitoring output current.</p> <ul style="list-style-type: none"> <li>• Two DC voltmeters (internal resistance of 10K ohm or greater) can be connected.</li> <li>• In case of DC ammeter (1mA full scale), it is necessary to add series resistance of 10K ohm (1/2W)</li> <li>• This output is a pulse output constant frequency (38.1 Hz) which has a variable duty.</li> </ul>
Contact Output	30A, B, C	Combined Alarm Output Terminals	<p>Output via no volt signal (contact1c) to indicate that the drive's protective function has been activated by an alarm.</p> <ul style="list-style-type: none"> <li>• Contact capacity (DC48V. 0.3A)</li> </ul>

C92-04

## 11. Operation

### Pre-Operation Inspection

- Check for wiring errors.
- Check that all loose wire stands, metal chips and unnecessary screws, etc. have been removed.
- Check that no screws, terminals, etc. are loose.
- Check that the wire ends of crimp terminal are not in contact with other terminals.

### Test Run Check Points

- Smooth rotation and correct rotation direction.
- No abnormal vibrations and noise from the motor.
- Smooth acceleration and deceleration.

### Frequency Setting Method

- Frequency setting by potentiometer control (factory preset at the time of shipment; F01:1). As wired at the factory, frequency setting can be performed by turning the potentiometer control knob on the keypad panel. Turn the potentiometer control knob clockwise to increase frequency.
- Frequency setting by digital signal (F01 : 0). With the function F01 set to 0, frequency can be increased or decreased by the UP/DOWN) keys on the keypad panel.  
UP: Frequency up  
DOWN: Frequency down

### RUN/STOP Method

- RUN/STOP by keypad panel operation (Factory preset at the time of shipment F02:0).

- The drive is shipped with a factory installed jumper, between FWD-CM. Only forward operation is possible. To enable reverse operation remove the jumper from FWD/CM and install the jumper between REV-CM.
- RUN/STOP by terminal operation (F02 : 1)

Note) Open FWD and REV terminals when changing F02 data. Data cannot be changed if not open.

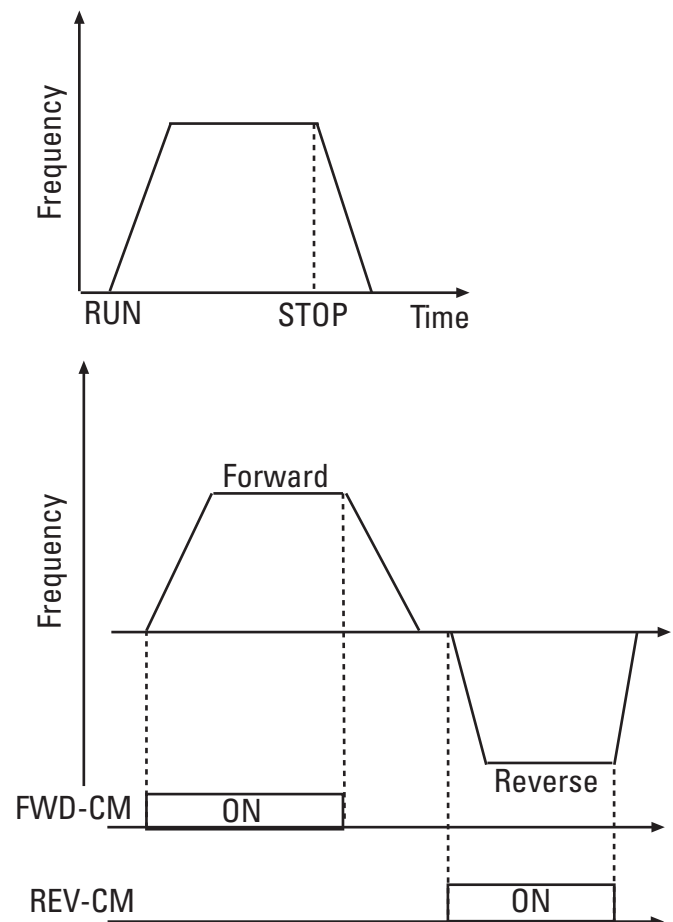

## Selecting Operation Method

With the FVR-C9S Series, the following methods can be selected to input the RUN/STOP signals and for frequency setting.

	RUN/STOP	Frequency Setting	Function Code setting
1	Keypad panel operation RUN/STOP Keys	UP/DOWN Keys*	F 0 1 = <input type="text"/> <input type="text"/> 0
2			Analog signal (DC0 - 10V)
3	Terminal operation (operation by external signal, FWD/REV terminals)	UP/DOWN Keys*	F 0 1 = <input type="text"/> <input type="text"/> 0
4			Analog signal (DC0 - 10V)

\* The frequency setting rate of change increases when FUNC/DATA key and UP/DOWN keys are pressed simultaneously

C92-07

## 12. Keypad Panel

### Part Names and Functions

**Digital monitor:**

In program mode, the keypad displays the various function codes and data values. During operation, it displays the output frequency, current, voltage, etc. If a fault occurs, the causes of the problem will be displayed as a code.

**PROGRAM key (RESET key):** Normal mode or program setting mode select key. If a fault occurs, this key is used to reset the fault.

**FUNCTION key (DATA key):** During normal mode, this key can be used to change the display unit (frequency display and output current display) while operation is either stopped or running. During the program setting mode, this key can be used to read and write the function codes and data.

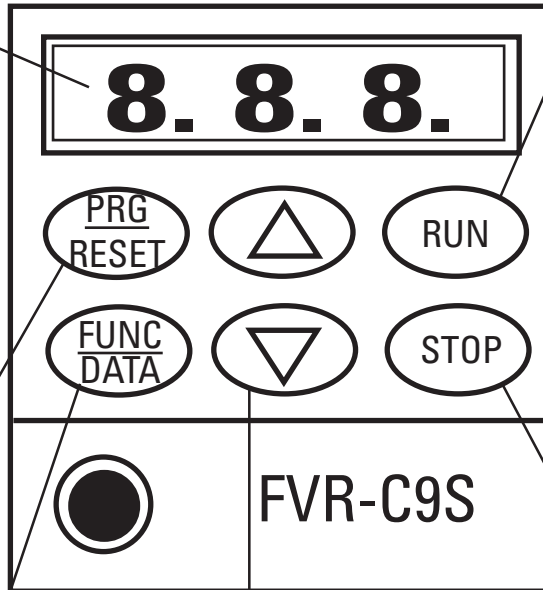

**RUN key:** This key is used for starting operation. The LED (green) lights up during operation. This key does not function when terminal operation control F02\_\_1 is selected.

**STOP key:** This key is used for stopping operation. This key does not function when terminal operation control F02 \_\_1 is selected.

**UP/DOWN keys:** These keys increase or decrease the frequency. When unit is in program setting mode, they change the function code or data values.

### Controlling Method for Keypad Panel

1) Monitor change

During the normal mode, frequency display and output current display can be changed by pressing the FUNC/DATA key.

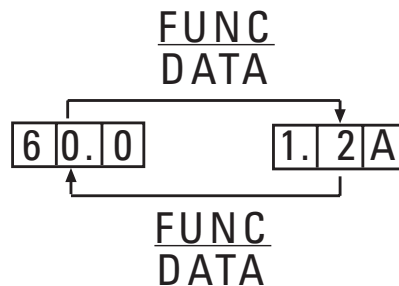

2) Run/Stop

When F02 is \_\_ 0): Press RUN) to run drive; press STOP to stop drive.







3) Frequency change

When F01 is \_\_ 0: Press UP to increase frequency; press DOWN to decrease frequency.

Note) If FUNC/DATA is pressed while pressing UP or DOWN, frequency changing speed increases.

# FVR-C9S-2UX

## 4) Function setting method

Method	Operation Procedure		Display						
1	 PRG/RESET	Press this key to switch to the program setting mode.	<table border="1"> <tr> <td>6</td> <td>0</td> <td>0</td> </tr> <tr> <td>F</td> <td>0</td> <td>0</td> </tr> </table>	6	0	0	F	0	0
6	0	0							
F	0	0							
2	 UP/DOWN	Press UP key or DOWN key to select function code	<table border="1"> <tr> <td>F</td> <td>0</td> <td>1</td> </tr> </table>	F	0	1			
F	0	1							
3	 FUNC/DATA	Press this key to display function code.	<table border="1"> <tr> <td></td> <td></td> <td>1</td> </tr> </table>			1			
		1							
4	 UP/DOWN	Press UP key or DOWN key to change function code data.	<table border="1"> <tr> <td></td> <td></td> <td>1</td> </tr> </table>			1			
		1							
5	 FUNC/DATA	Press this key to store data.	<table border="1"> <tr> <td>F</td> <td>0</td> <td>2</td> </tr> </table>	F	0	2			
F	0	2							
6	Change other function code  PRG/RESET	Press this key to cancel program mode	<table border="1"> <tr> <td>6</td> <td>0</td> <td>0</td> </tr> </table>	6	0	0			
6	0	0							

C92-06



## 13. Function Explanation

### Function Code Tables

Function Code	Function	Date Code Range	Unit	Min. Set.	Factory Setting	Change During Operation
F00	Data protection	0: Data change possible 1: Data change not possible	—	—	0	No
F01	Frequency Command	0: Keypad panel (UP/DOWN keys) 1: Analog input (VR, DC0 - 10V or DC4 - 20mA)	—	—	1	No
F02	Operation Command	0: Keypad panel operation (RUN/STOP keys) 1: External signal operation (FWD/REV terminals)	—	—	0	No
F03	Maximum Frequency	50 - 120 Hz	Hz	1	60 Hz	No
F04	Base Frequency	50 - 120 Hz	Hz	1	60 Hz	No
F05	Acceleration Time	0.0 - 60s (0.0 setting = 0.01s)	s	0.1	6.0s	Yes
F06	Deceleration Time	0.0 - 60s (0.0 setting = 0.01s)	s	0.1	6.0s	Yes
F07	Torque Boost	0 - 31 (code)	—	—	13	Yes
F08	Electronic Thermal Overload Relay Operation	0: Inactive 1: Active (standard 4-pole motor) 2: Active (forced-air cooled motor)	—	—	0	No
F09	Electronic Thermal Overload Relay Level	30 - 105% of rated current of drive	%	1	100%	No
F10	Restart after Momentary Power Failure	0: Inactive 1: Active (Restart drive in 0.5s after power failure)	—	—	0	No
F11	Gain for Frequency Setting Signal	0: For 0 - 10 V 1: For 0 - 5 V	—	—	0	No
F12	DC Brake (Level Setting)	0 - 100%	—	1	50%	Yes
F13	DC Brake (Time)	0.0 (inactive) 0.1 - 30s	s	0.1	0.1s	Yes
F14	Starting Frequency	1 - 6 Hz	Hz	1	1 Hz	No

# FVR-C9S-2UX

## Function Code Tables

Function Code	Function	Date Code Range	Unit	Min. Set.	Factory Setting	Change During Operation
F15	Motor Running Sound	0 - 5 (code)	—	—	5	Yes
F16	Fault Memory	The current and previous 3 fault events are displayed in order of occurrence	—	—	—	No
F17	Data Initialization	0: Inactive 1: Reset to the initial value (value set at factory)	—	—	0	No
F18	Retry	0: Inactive 1: Active (Retry times fixed at 5, Retry starts in .05s after trip)	—	—	0	No
F19	Motor Characteristics	0 - 10	—	—	4	Yes
F20	Jump Frequency Range	0 - 10Hz	Hz	1	3	Yes
F21	Jump Frequency 1	0 - 120Hz	Hz	1	0	Yes
F22	Jump Frequency 2	0 - 120 Hz	Hz	1	0	Yes
F23	Jump Frequency 3	0 - 120 Hz	Hz	1	0	Yes
F24	High Limiter	0 - 100%	%	1	100	Yes
F25	Low Limiter	0 - 100%	%	1	0	Yes
F26	Bias Setting	0 - 100%	%	1	0	Yes
F27	THR Terminal Function	0: External alarm input 1: Multistep speed selection (X1)	—	—	0	No
F28	BX Terminal Function	0: Motor coast-to-stop command input 1: Multistep speed selection (X2)	—	—	0	No
F29	Multistep Speed Setting 1	0.0 - 120 Hz	Hz	1*	10.0 Hz	Yes
F30	Multistep Speed Setting 2	0.0 - 120 Hz	Hz	1*	20.0 Hz	Yes
F31	Multistep Speed Setting 3	0.0 - 120 Hz	Hz	1*	30.0 Hz	Yes
F32	Meter Adjustment	0 - 99 (Full scale DC 6.5 - 10.5V)	—	1	85	Yes
F33	Meter Output selection	0: Output frequency monitor 1: Output current monitor	—	1	0	Yes

\*1 Frequency can be set in increments of 0.1 Hz within a range of 0.0 to 99.9 Hz, and can be set in increments of 1 Hz

C92-02

## Detailed Explanation of Each Function Code

### F 0 0 Data Protection

The set data can be locked so that it will not be changed by mistake.

		0	Data change possible
		1	Data change not possible

To change data simultaneously press the STOP key and either the UP/DOWN key.

### F 0 1 Frequency Command

Either of the following two frequency setting methods can be selected.

		0	Keypad panel setting (UP/DOWN keys)
		1	Analog input (setting by volume control, 0 -10VDC or 4 - 20mA)

### F 0 2 Operation Command

Either of the following two control methods can be selected.

		0	Keypad panel operation (RUN/STOP keys)
		1	External signal operation (FWD/REV keys)

### F 0 3 Maximum Frequency

Sets the maximum value for the output frequency

	5	0	Frequency can be set in increments of 1 Hz within a range of 50 to 120 Hz
1	2	0	

Multipurpose motors and other motors which are designed to operate at low speed can be damaged if operated at high frequency. Be sure to set the frequency to match the characteristics of the motor.

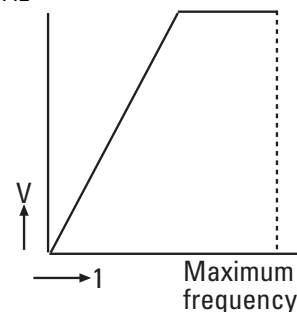

### F 0 4 Base Frequency

Sets the base frequency (the frequency which is the divergent point of the specified torque characteristics and the specified output characteristics).

	5	0	Frequency can be set in increments of 1 Hz within a range of 50 to 120 Hz
1	2	0	

- Set to match the characteristics of the motor.
- Although the base frequency may exceed the maximum frequency, in that case the voltage will be decreased accordingly.

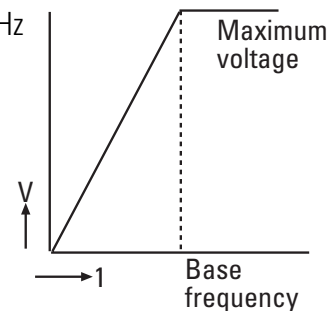

### F 0 5 Acceleration Time

### F 0 6 Deceleration Time

	0.	0	The time required to reach the maximum output frequency can be set within a range of 0.0s to 60s (in increments of 0.1s).
6	0.	0	

Note: 0.0s setting is taken for 0.01s for acceleration and 0.1s for deceleration.

## F 0 7 Torque Boost

Can be set from among 32 different levels in accordance with the type of load, the characteristics of the motor, etc.

		0	For a reduced torque load (fan, pump, etc.)
		1	
		2	Low
	3	1	High

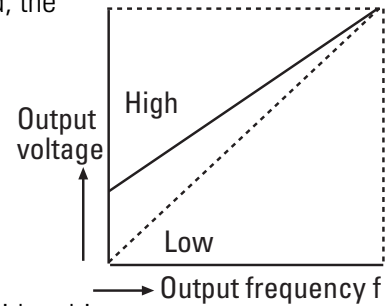

		8	Set to match this when using a Fuji FV motor designed for use with a drive.
--	--	---	---

## F 0 8 Electronic Thermal Overload Relay

Either of the following two can be selected.

		0	Inactive
		1	Active (electronic thermal overload relay protection) For a standard 4-pole motor
		2	Active (electronic thermal overload relay protection) For a Fuji FV motor

## F 0 9 Electronic Thermal Overload Relay Level

Sets the operation level for the electronic thermal overload relay.

	3	0	Setting range: 30 to 105% (increments of 1%)
1	0	5	

$$\text{Setting value (\%)} = K \times \frac{\text{Motor's rated current}}{\text{Drive's rated current}} \times 100$$

Drive Capacity	Wiring Length : feet			
	0	130	165	325 655
F12C9S-2UX	K = 1.2	External thermal OL relay is recommended		
F25C9S-2UX	K = 1	K = 1.1	K = 1.2	
F50C9S-2UX	K = 1		K = 1.1	
001C9S-2UX	K = 1			
002C9S-2UX				
003C9S-2UX				
005C9S-2UX				

C92-10

# FVR-C9S-2UX

Derating characteristics for the continuously allowable current

1) For a standard 4-pole motor \_\_ 1 2) for a forced-air cooled motor \_\_ 2

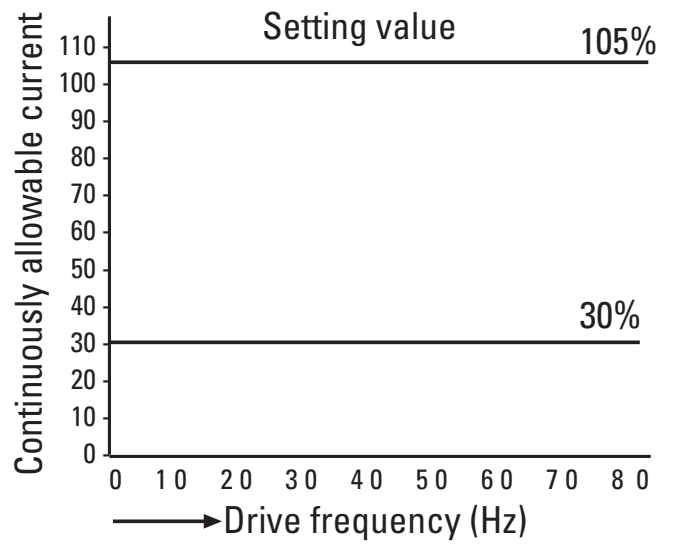
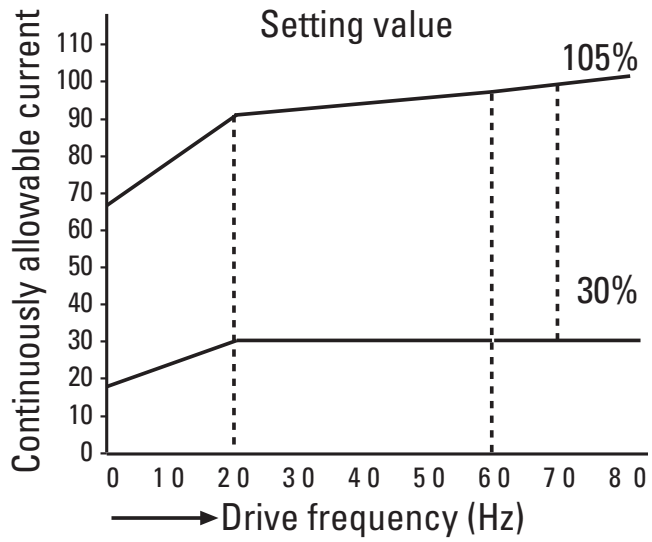

## F 1 0 Restart After Momentary Power Failure

It is possible to select whether or not to restart operation when power supply is resumed after momentary power failure.

0 Inactive

While stopped: Stopped condition is maintained even after power supply has been restored.

While running: After power supply has been restored. LU is lit and an alarm is outputted.

1 Active

Operation is restarted in 0.5s after power supply has been restored. (When drive is stopped, it is maintained in the stopped condition even after power supply has been restored).

This is valid only if power supply is restored while LU is lit. The length of time that LU will remain lit after a power failure occurs is as follows.

Drive Model	F12	F25	F50	001	002	003	005
Time(s)	0.7	0.7	1.4	1.4	4.0	5.5	9.0

## F 1 1 Gain for Frequency Setting Signal

Outputs a frequency which is a proportional ratio of the analog frequency setting.

Selects an analog input signal level when F 0 1 is \_\_ 1.

0 Maximum frequency is outputted at 10V

1 Maximum frequency is outputted at 5V

When used together with the frequency setting bias, this frequency setting gain takes priority, and the bias applied to the frequency after the gain has been applied.

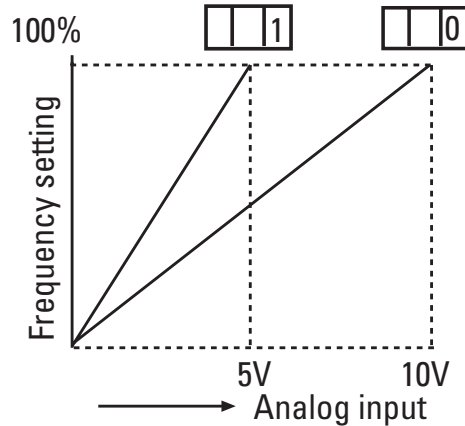

## F 1 2 DC Brake

The current level of DC brake can be set.

Taking the rated current of the drive as 100%, this current level can be set in increments of 1%.

## F 1 3 DC Brake (Braking Time)

The DC braking time can be set.

0.0 Inactive

0.1 - 30.0 Braking time can be set within a range of 0.1 to 30s (in increments of 0.1s)

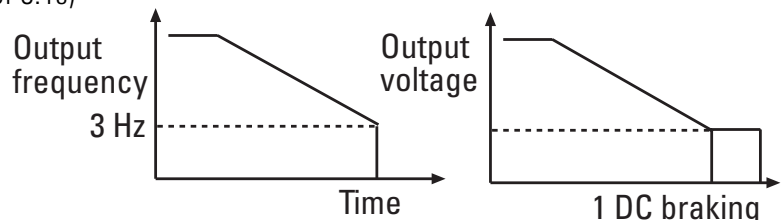

## F 1 4 Starting Frequency

The starting frequency can be set in increments of 1 Hz within a range of 1 to 6 Hz. Note that stopping will also occur at the frequency set by this function.

		1	1 Hz
		6	6 Hz

Set to 2 Hz when using a high speed motor.

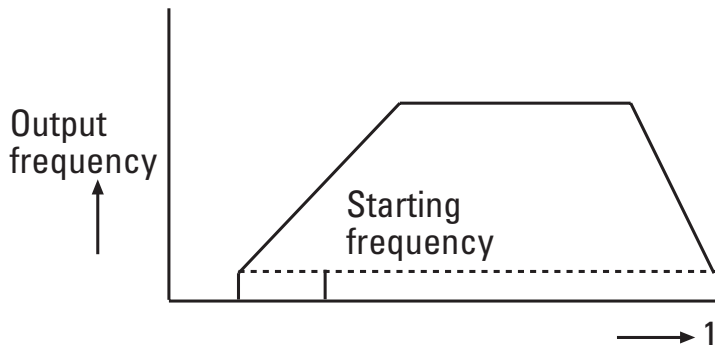

## F 1 5 Motor Running Sound

The sound of the motor operation can be changed by changing the carrier frequency.

		0	Select from among 5 levels in accordance with the usage conditions.
		5	

Data code

- 0 Low carrier frequency
- 5 High carrier frequency (low noise)

## F 1 6 Fault Memory

The current and previous 3 fault events are stored in memory.

The data for each can be displayed by using the DOWN key.

The procedure for displaying the data is as follows:

No.	Procedure	Display (ex)	Remarks
1	Display		
	<div style="border: 1px solid black; padding: 2px; display: inline-block;">F 1 6</div>	<div style="border: 1px solid black; padding: 2px; display: inline-block;">F 1 6</div>	
2	Press FUNC/DATA Key		The information for the latest trip will be displayed
	↓	↑	
	Press DOWN Key	<div style="border: 1px solid black; padding: 2px; display: inline-block;">F 0 1</div>	The information for the first preceding trip will be displayed
	↓	↑	
3	Press DOWN Key	<div style="border: 1px solid black; padding: 2px; display: inline-block;">O H 2</div>	The information for the second preceding trip will be displayed
	↓	↑	
4	Press DOWN Key	<div style="border: 1px solid black; padding: 2px; display: inline-block;">O C 1</div>	The information for the third preceding trip will be displayed.
	↓	↑	
5	Press DOWN Key	<div style="border: 1px solid black; padding: 2px; display: inline-block;">- - -</div>	(in this example, there is no history of a third preceding trip).
	↓	↑	
6	Press DOWN Key	<div style="border: 1px solid black; padding: 2px; display: inline-block;">E n d</div>	

C92-12

The information for any new trip will be stored in the area for the "information for the latest trip" shown above, each trip history will be removed downward and the "information for the third preceding trip" will be erased.

## F 1 7 Data Initialization

Reset the data for all of the functions to the value set at the factory.

		0	Inactive
--	--	---	----------

		1	Resets to the value set at the factory.
--	--	---	---

From the \_\_ 0 display, by simultaneously pressing STOP and UP, the display will change to \_\_ 1.

By pressing FUNC/DATA in this state, the data will be reset to the value set at the factory, and the mode will automatically change to the 6 0. 0 frequency display mode.

## F 1 8 Retry

The number of times of retry for automatic restart after the drive has been tripped can be set.

		0	The number of retry times is fixed at 5. Retry takes place in 0.5s after trip
--	--	---	---

		1	
--	--	---	--

Note that the retry takes place only in the case where the drive is tripped due to overcurrent or overvoltage applied during operation.

## F 1 9 Motor Characteristics

Used to compensate for output current instability.

## F 2 0 Jump Frequency Range

## F 2 1 Jump Frequency 1

## F 2 2 Jump Frequency 2

## F 2 3 Jump Frequency 3

Frequency is jumped so that the mechanical common point of load and the output frequency of drive do not coincide with each other.

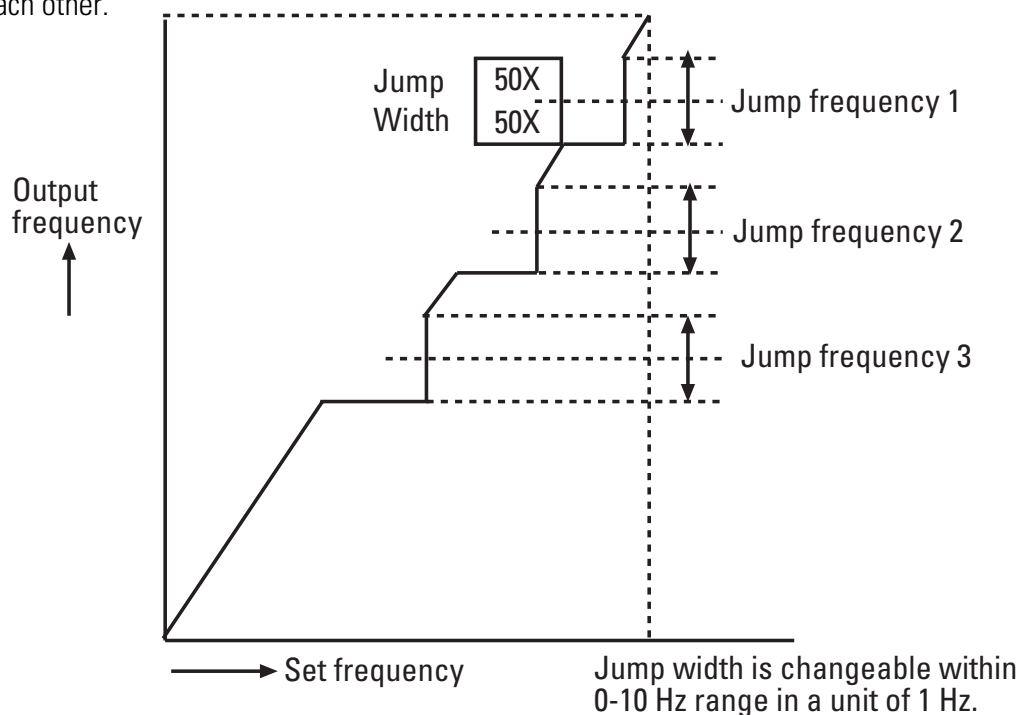



F	2	4	<b>High Limiter</b>
---	---	---	---------------------

F	2	5	<b>Low Limiter</b>
---	---	---	--------------------

The upper and lower and lower limits of the output frequency can be set.

		0	Set as a percentage of the maximum frequency in increments of 1% within a range of 0 to 100%
1	0	0	

If the value set for low limiter is higher than that set for the high limiter, the high limiter will take priority and the low limiter will be ignored. Thus, operation will always be in accordance with the high limiter value regardless of the frequency setting.

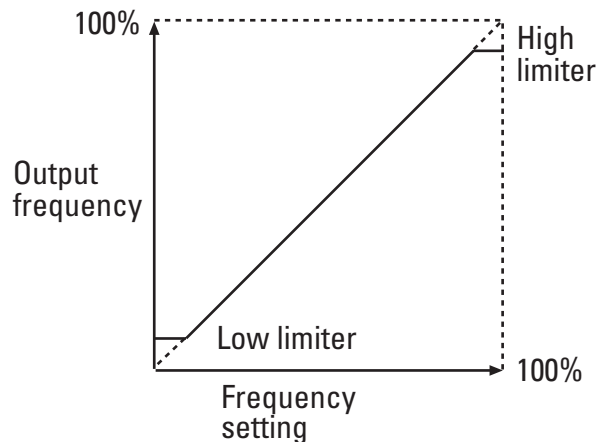

F	2	6	<b>Bias Frequency</b>
---	---	---	-----------------------

Outputs a bias frequency with respect to the analog frequency setting.

		0	Set as a percentage of the maximum frequency in increments of 1% within a range of 0 to 100%
1	0	0	

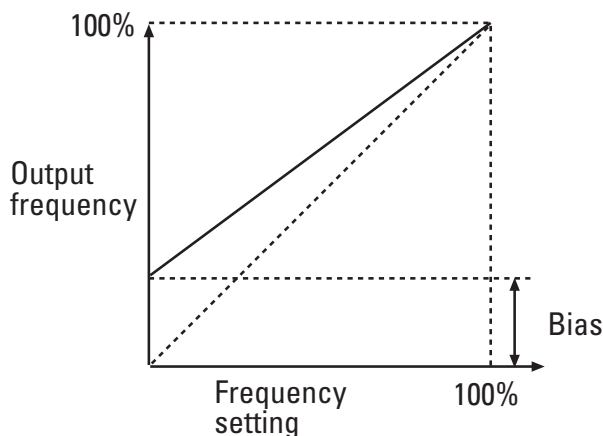

F	2	7	<b>THR Terminal Function</b>
---	---	---	------------------------------

This function enables terminal THR to be used for two different functions by changing the data code as follows:

		0	External alarm input
		1	Multistep speed selection (X1)

This function data cannot be changed during operation. (Possible to change only in STOP mode).

F	2	8	<b>BX Terminal Function</b>
---	---	---	-----------------------------

This function enables terminal BX to be used for two different functions by changing the data code as follows:

		0	Motor coast-to-stop command input
		1	Multistep speed selection (X2)

This function data cannot be changed during operation. (Possible to change only in STOP mode).

# FVR-C9S-2UX

F 2 9	Multistep Speed Setting 1 (Speed 1)
F 3 0	Multistep Speed Setting 2 (Speed 2)
F 3 1	Multistep Speed Setting 3 (Speed 3)

Multistep speeds can be set within a range of 0 to 120 Hz only by changing the contact signal from outside. (X1-CM X2-CM). Setting of speed of optional step is possible within a range of 0 to 120 Hz during drive operation

(Note1) X1 or X2 terminal is selected via THR/BX terminal function change (F27, F28)

(Note 2) In selecting THR/BX terminal function (F27, F28) individual setting is possible.

Terminal / Function Code	F27 : 1 F28: 0	F27: 0 F28: 1	F27: 1 F28: 1	F27: 0 F28: 0
THR	X1	External Alarm input	X1	External alarm input
BX	Motor coast-to-stop command input	X2	X2	Motor coast-to-stop command input

C92-09

Speed 0 Frequency setting is made by either the analog signal or the keypad panel.

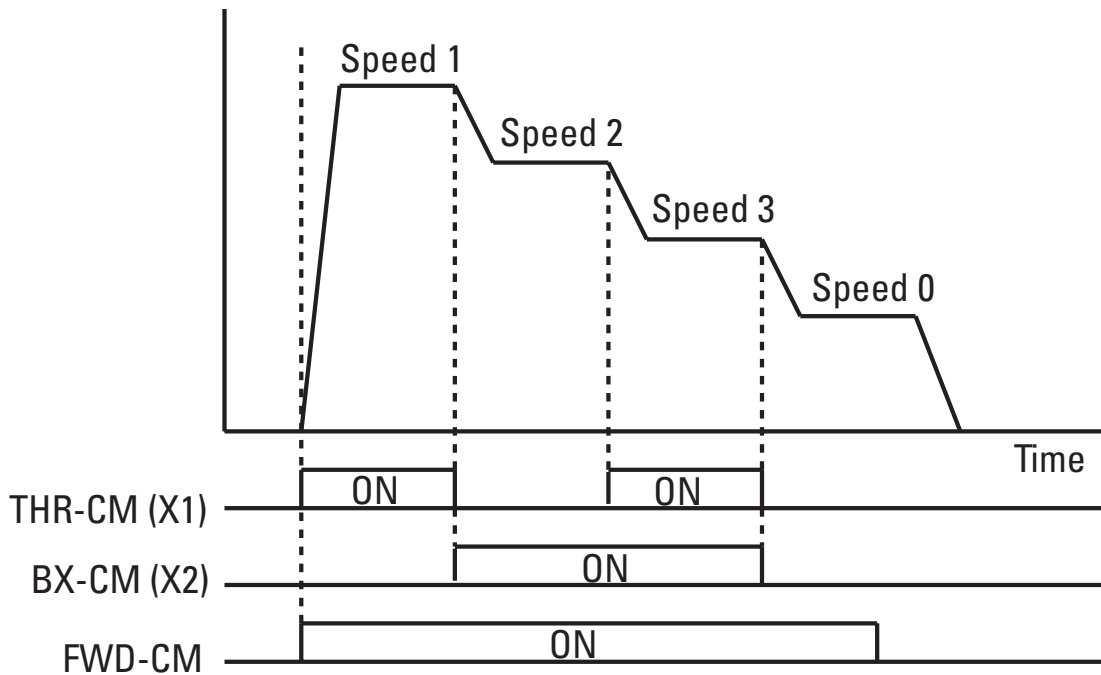

## F 3 2 FM Terminal Output Level Calibration

Adjust the level of the voltage output to terminal FM for the frequency meter.

		0	Approximate DC 6.5V at full scale
	9	9	Approximate DC 10.3V at full scale

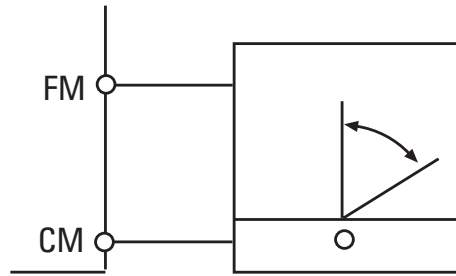

Note: The FM terminal output is a pulse output of which frequency is constant (38.1 Hz) and duty is variable.

## F 3 3 FM Terminal Function Selection

With regard to the data outputted to the FM terminal, either the output frequency or the output current can be selected.

		0	Output frequency
		1	Output current

## 14. Protective Functions

Function	Explanation	Display	Alarm Output
Momentary Overcurrent Protection	Stops drive to protect it against overcurrent . OC1 = During acceleration OC2 = During deceleration OC3 = During constant speed operation	OC1 OC2 OC3	Yes
Overvoltage Protection	Detects overvoltage of DC intermediate circuit and stops drive.	OU	Yes
Undervoltage Protection	Detects undervoltage of DC intermediate circuit and stops drive.	LU	Yes*
Protection against overheating of cooling element	Detects abnormal temperature rise of cooling element and stops drive	OH1	Yes
External Alarm Input	Stops drive by input of an external signal.	OH2	Yes
Electronic Thermal Overload	Detects overload of motor and stops drive.	OL	Yes
Drive Overload	Detects overload of drive and stops drive.	OLU	Yes
Memory Error	Stops drive in case of memory error	Er1	Yes
CPU Error	Stops drive in case of a CPU error	Er3	Yes

\* This output is selectable by F10

C92-05

## ***15. Warranty Parts and Service***

The purpose of the following section to provide specific instructions to the user of the FVR-C9S-7UX drive regarding warranty administration and how to obtain assistance on both in-warranty and out-of-warranty equipment.

If assistance is required to determine warranty status call:

**Technical Services  
GE Fuji Drives USA, Inc.**

**1-540-387-5739**

**24-hour Emergency 1-540-387-8292**

### **Warranty Coverage**

The warranty set forth in Section 1 of FN-1090 (1/91) of GE's Condition of Sale covers all major parts of the drive such as the main printed circuit boards, transistor modules, etc. The warranty covers replacement of the entire drive.

“Warranty period is 12 months after installation or 18 months after shipment from the Company, whichever occurs first.”

Before calling the number at left to determine warranty status, the drive serial number will be required. This is located on the drive nameplate. If the drive is still under warranty, further information will be required per the “In-Warranty Failure Checklist” shown on page 36 of this instruction book.

### **Out-of-Warranty Procedures**

If a defective drive is out-of-warrant contact an Authorized GE Fuji Service Provider for repair or an Authorized GE Fuji Distributor for replacement.

### **Motors**

Repairs on motors are generally handled by the motor manufacturer. For specific instructions on your motor, call the distributor from which it was purchased and be prepared to furnish complete nameplate data.

## In-Warranty Failure Checklist

To assist with warranty troubleshooting, the following information is required. This data is needed to evaluate the cause in an effort to eliminate any further failures.

**Model No.:** \_\_\_\_\_

**Serial No.:** \_\_\_\_\_

**Start-Up Date:** \_\_\_\_\_

**Failure Date:** \_\_\_\_\_

**Status When Failure Occurred** (check one):

Power-Up \_\_\_\_\_ Running \_\_\_\_\_ Accel \_\_\_\_\_ Decel \_\_\_\_\_

**Explanation of Failure:** \_\_\_\_\_

**Application Information** (check Yes or No)

**Input Transformer:** Yes \_\_\_\_\_ No \_\_\_\_\_

If Yes: KVA \_\_\_\_\_

L1 Volts \_\_\_\_\_ L2 Volts \_\_\_\_\_ L3 Volts \_\_\_\_\_

**Power Factor Correction Capacitors:** Yes \_\_\_\_\_ No \_\_\_\_\_

If Yes: Microfarad \_\_\_\_\_

**Other Equipment on Same Power** Yes \_\_\_\_\_ No \_\_\_\_\_

If Yes, what?

**Line Reactor on Input** Yes \_\_\_\_\_ No \_\_\_\_\_

**Input Starter** Yes \_\_\_\_\_ No \_\_\_\_\_

**Output Starter** Yes \_\_\_\_\_ No \_\_\_\_\_

**Motor Overloads** Yes \_\_\_\_\_ No \_\_\_\_\_

**Control Terminals Used** (circle if used)

THR	X1	X2	X3	30A	30B	30C
RST/BX	FWD	REV	C1	11	12	13
RUN	RT1					

**Function Codes Different From Factory Settings**

Function Code	Setting	Function Code	Setting
_____	_____	_____	_____
_____	_____	_____	_____
_____	_____	_____	_____
_____	_____	_____	_____

**Failure Message** (see Section 5)

**Latest Fault** \_\_\_\_\_ **Previous Faults:** **No Message** \_\_\_\_\_

Hz \_\_\_\_\_ 1. \_\_\_\_\_

A \_\_\_\_\_ 2. \_\_\_\_\_

V \_\_\_\_\_ 3. \_\_\_\_\_

After all of the Checklist information is acquired, contact the following Service Center number for assistance:  
**540-387-5739 (8am - 5pm Central Standard time Monday thru Friday).**  
**540-387-8292 (24-hour emergency)**

When you return the unit for warranty you need to get a RMA number from your Service Center.

***Notes:***

***Notes:***





**FUJI**  
**ELECTRIC**  
*The Drive that Powers*

*GE Fuji Drives USA, Inc.  
1501 Roanoke Blvd. Suite 435  
Salem, VA 24153*

*1-800-543-6196  
Internet Address: <http://www.ge.com>*



## Artisan Technology Group is your source for quality new and certified-used/pre-owned equipment

- FAST SHIPPING AND DELIVERY
- TENS OF THOUSANDS OF IN-STOCK ITEMS
- EQUIPMENT DEMOS
- HUNDREDS OF MANUFACTURERS SUPPORTED
- LEASING/MONTHLY RENTALS
- ITAR CERTIFIED SECURE ASSET SOLUTIONS

### SERVICE CENTER REPAIRS

Experienced engineers and technicians on staff at our full-service, in-house repair center

### *InstraView*<sup>SM</sup> REMOTE INSPECTION

Remotely inspect equipment before purchasing with our interactive website at [www.instraview.com](http://www.instraview.com) ↗

### WE BUY USED EQUIPMENT

Sell your excess, underutilized, and idle used equipment. We also offer credit for buy-backs and trade-ins. [www.artisanng.com/WeBuyEquipment](http://www.artisanng.com/WeBuyEquipment) ↗

### LOOKING FOR MORE INFORMATION?

Visit us on the web at [www.artisanng.com](http://www.artisanng.com) ↗ for more information on price quotations, drivers, technical specifications, manuals, and documentation

**Contact us:** (888) 88-SOURCE | [sales@artisanng.com](mailto:sales@artisanng.com) | [www.artisanng.com](http://www.artisanng.com)