



## Artisan Technology Group is your source for quality new and certified-used/pre-owned equipment

- FAST SHIPPING AND DELIVERY
- TENS OF THOUSANDS OF IN-STOCK ITEMS
- EQUIPMENT DEMOS
- HUNDREDS OF MANUFACTURERS SUPPORTED
- LEASING/MONTHLY RENTALS
- ITAR CERTIFIED SECURE ASSET SOLUTIONS

### SERVICE CENTER REPAIRS

Experienced engineers and technicians on staff at our full-service, in-house repair center

### *InstraView*<sup>SM</sup> REMOTE INSPECTION

Remotely inspect equipment before purchasing with our interactive website at [www.instraview.com](http://www.instraview.com) ↗

### WE BUY USED EQUIPMENT

Sell your excess, underutilized, and idle used equipment. We also offer credit for buy-backs and trade-ins. [www.artisanng.com/WeBuyEquipment](http://www.artisanng.com/WeBuyEquipment) ↗

### LOOKING FOR MORE INFORMATION?

Visit us on the web at [www.artisanng.com](http://www.artisanng.com) ↗ for more information on price quotations, drivers, technical specifications, manuals, and documentation

**Contact us:** (888) 88-SOURCE | [sales@artisanng.com](mailto:sales@artisanng.com) | [www.artisanng.com](http://www.artisanng.com)

GE Fanuc Intelligent Platforms

# Datapanel

Models 150, 160 and 240E

User's Manual, GFK-2028B

April 2008



## *Warnings, Cautions, and Notes as Used in this Publication*

### Warning

Warning notices are used in this publication to emphasize that hazardous voltages, currents, temperatures, or other conditions that could cause personal injury exist in this equipment or may be associated with its use.

In situations where inattention could cause either personal injury or damage to equipment, a Warning notice is used.

### Caution

Caution notices are used where equipment might be damaged if care is not taken.

### Note

Notes merely call attention to information that is especially significant to understanding and operating the equipment.

This document is based on information available at the time of its publication. While efforts have been made to be accurate, the information contained herein does not purport to cover all details or variations in hardware or software, nor to provide for every possible contingency in connection with installation, operation, or maintenance. Features may be described herein which are not present in all hardware and software systems. GE Fanuc assumes no obligation of notice to holders of this document with respect to changes subsequently made.

GE Fanuc makes no representation or warranty, expressed, implied, or statutory with respect to, and assumes no responsibility for the accuracy, completeness, sufficiency, or usefulness of the information contained herein. No warranties of merchantability or fitness for purpose shall apply.

The following are trademarks of GE Fanuc Intelligent Platforms.

Alarm Master	Genius	ProLoop	Series Six
CIMPLICITY	Helpmate	PROMACRO	Series Three
CIMPLICITY 90-ADS	Logicmaster	PowerMotion	VersaMax
CIMSTAR	Modelmaster	PowerTRAC	VersaPoint
Field Control	Motion Mate	Series 90	VersaPro
GENet	PACSystems	Series Five	VuMaster
	Proficy	Series One	Workmaster

©Copyright 2001–2008 GE Fanuc Intelligent Platforms, Inc.  
All Rights Reserved

<b>Overview.....</b>	<b>1-1</b>
Related Publications .....	1-2
Configuration Software .....	1-2
Industrial Housing .....	1-2
Components of the System .....	1-2
Datapanel Specifics .....	1-3
Models 150/160.....	1-3
Model 240E .....	1-3
<b>Installing the Hardware .....</b>	<b>2-1</b>
Mounting Datapanel.....	2-2
Connection Cables.....	2-3
<b>Operation Guide .....</b>	<b>3-1</b>
Routine Processing .....	3-2
Viewing Other Pages .....	3-2
Viewing Overview Groups.....	3-2
Printing a Page.....	3-3
Alarm Conditions .....	3-3
Drive Out .....	3-4
Edit Mode .....	3-5
<b>Special Operations: Mode Menu .....</b>	<b>4-1</b>
Exit .....	4-1
About Menu.....	4-1
Display Control Menu .....	4-4
Models 150/160.....	4-4
Model 240E .....	4-5
PLC Fault Screens.....	4-6
Configuring PLC Fault Screen Options.....	4-6
Selecting the PLC .....	4-6
PLC Faults Screen .....	4-6
I/O Fault Screen .....	4-7
Set PLC State .....	4-8
Off-Line Mode .....	4-9
Configure Serial Port (Model 150 Only) .....	4-10
Set Time and Date Display .....	4-10
Host Transfer .....	4-11
Enable/Disable Alarms.....	4-11

<b>Specifications .....</b>	<b>5-1</b>
Hardware Specifications .....	5-1
Display.....	5-1
Backlight.....	5-1
Keypad .....	5-2
LED Indicators.....	5-2
Technical Specifications .....	5-3
Electrical Specifications .....	5-4
Power Requirements.....	5-4
Ports and Pinouts.....	5-5
Data Retention .....	5-6
Real-Time Clock .....	5-7
Environmental Conformity .....	5-7
Networking with Datapanel .....	5-7
<b>Error Codes.....</b>	<b>A-1</b>
Standard Comms Block Error Codes.....	A-1
Controller Errors.....	A-1

# Chapter 1

## Overview

---

---

A Datapanel is a low-cost human-machine interface that enables the transfer of data from a programmable logic controller or other intelligent control device to a comprehensive operator terminal. Datapanel is a self-contained, solid state industrial display system incorporating its own display screens and keypads. A Datapanel's many configurable options allow it to meet application requirements ranging from simple pushbutton replacement to complex interfaces beyond the capabilities of most small OIs. Standard features of Datapanel models include:

- **Controller Communications.** Reads and writes data to the control equipment via a serial port. The Datapanel models 240E and 160 support Profibus and Genius communications on optional PC/104-based cards.
- **Integrated Keypad.** Includes programmable function keys.
- **Broad Protocol Support.** Over 80 protocols supported.
- **Analog and Digital Tag Scaling.** Converts raw data to and from engineering units, and adds tag name information.
- **Display Real-Time Data.** Provides information on the current state of the plant process.
- **PLC data via several datatypes.** Unsigned/signed words, signed/unsigned double word, IEEE754 floating point, ASCII text, and bit.
- **Optional Display Modes.** Continuous updates; updates continuously only when page is displayed; or updates once when page is first displayed.
- **Alarm Manager.** Checks for analog and digital alarms, maintains a log of active alarms and supports operator acknowledgment of alarms.
- **Graphic Page Display.** Displays static and dynamic text on up to 100 user-configured pages per Datapanel. Up to 512 dynamic elements may be updated from the controller per page. Multiple font sizes allow for emphasis of important data.
- **Softkeys.** Six keys (eight keys if the up/down  $\sigma$   $\tau$  keys used) per page, for up to 800 user-defined buttons per Datapanel. Buttons may change pages, write data, or perform other OI functions.
- **Overview Display.** Preconfigured tabular display of Datapanel and controller data.
- **NEMA 4/12 (IP65) Rated.** Ruggedized for harsh industrial environments.

For model-specific features, see "Datapanel Specifics" on page 1-3.

## *Related Publications*

- GFK-1658** *Data Designer Software User's Manual*  
**GFK-1712** *Important Product Information*  
**GFK-1698** *VT100 Terminal Emulator for Datapanel User's Manual*

## *Configuration Software*

Configuration of a Datapanel is quick and easy. Datapanel features a common software environment, which means that configuring one model is just like configuring another. A PC-based tool, DataDesigner, operating under Windows is used to create a database for the Datapanel. The database and communications protocol are loaded to the Datapanel via a serial port, and the OI can then be put on-line. The configuration software is sold separately and requires a PC-compatible computer running Windows<sup>®</sup> 95, Windows 98, Windows NT<sup>®</sup>, or Windows 2000.

**Note:** Datapanel is shipped from the factory without any system software (.cmd file). If your Datapanel needs system software, the startup screen displays the message "Waiting for Software." Some models also display "Checksum Error," which does not indicate that there is a fault with the panel, just that it needs a .cmd file.

If you attempt to download a database to a Datapanel that does not have system software, a screen prompting you to load a .cmd file appears. When you click OK, a file selection dialog listing the .cmd file for your Datapanel model appears. When you select the .cmd file, it is loaded and the database and/or protocol download proceeds automatically.

## *Industrial Housing*

Datapanel is designed for use in demanding industrial applications. All hardware is designed to meet industrial application requirements. Datapanel is of compact shallow design. All front external surfaces are sealed and protected to NEMA 4/12 (IP65) standards against the penetration of water and foreign particles.

## *Components of the System*

A Datapanel system includes:

- One Datapanel unit, incorporating an LCD display screen and an integrated membrane keypad.
- One Operator's Manual (this book).
- Six mounting clips.
- One power supply mating connector (attached to Datapanel).

Although Datapanel is self-contained units, a PC is necessary to configure the system and to download databases to the Datapanel.

---

<sup>®</sup> Windows and Windows NT are registered trademarks of Microsoft Corporation.

---

## *Datapanel Specifics*

**Note:** All three Datapanels use the same panel mounting cutout dimensions.

### *Models 150/160*

The Models 150 and 160 are good choices for pushbutton replacement. With six user function keys available on each of 100 pages, up to 600 pushbuttons can be defined. The arrow keys ( $\sigma$   $\tau$ ) can also be programmed. An extensive list of protocols is supported, making the Datapanel compatible with many supervisory products. The powerful runtime software that is standard on all Datapanels can be used to manage alarms, report diagnostic information and enter operator data.

The primary differences between the Models 150 and 160 are that the Model 150 has only one serial port and does not support bar graphs, bitmaps, meters, trends, or PC/104 expansion.

The Datapanel 160 has a battery-backed on-board real-time clock that is used to accurately time stamp all system events. The Datapanel 150 has no real-time clock.

The Datapanel 160 provides a second serial port for serial printing of alarm messages and reports, providing a hard copy of all system events. Instead of printing, the second serial port can be used to run a second protocol independent of the first serial port.

The model 160 supports PC/104 expansion. The model 160 software includes real-time trends.

For a list of features, refer to Table 1-1.

### *Model 240E*

The Model 240E has all the capabilities of the Model 160 plus a touch-screen. A 48-point touch input system, six user function keys, and four control keys enhance the versatility of the Model 240E. A bright 240 x 128 pixel LCD display offers excellent visibility.

For a list of features, refer to Table 1-2.



Table 1-1. Summary of Datapanel 150/160 Features and Capabilities

<b>Features &amp; Capabilities</b>	<b>Datapanel Model 150</b>	<b>Datapanel Model 160</b>
Processor	AMD AM188EM-20MHz	AMD AM186ES-32MHz
LCD Display Size (pixels)	240x64	240x64
Database Size	64k	64k
Backlight	LED	LED
Memory, Flash	512KB Flash	512KB Flash
Memory, SRAM or DRAM	128KB SRAM	256KB SRAM
Serial Ports	One RS232/485	One RS232/485, one RS232
Standard Software Features	Tag scaling, static and dynamic data display, alarm manager, read/write to controller, overview display, configurable function keys, downloadable database and protocol, variable text sizes	Tag scaling, static and dynamic data display, alarm manager, read/write to controller, overview display, configurable function keys, downloadable database and protocol, variable text sizes, graphical drawing objects
Bar Graphs	No	Yes
Bitmap Graphics	No	Yes
Real-Time Trends	No	Yes
VT 100 Emulation	Yes, option	Yes, option
PC/104 Expansion	No	Yes
Function Keys per Page	Six (The ↑↓ arrow keys can also be programmed.)	Six (The ↑↓ arrow keys can also be programmed.)
Data Entry Keypad	22 keys	22 keys
Touch Screen	No	No
Controller Protocols	Over 80 supplied, including GE Fanuc, Modicon, Allen Bradley, Square D, Mitsubishi, Omron, Siemens, Idec etc. Call for details.	
Analog Tags	500	500
Digital Tags (2 bits per tag)	500	500
Display Pages	100	100
NEMA, UL, CUL, CE	4X/4/12, UL (C1ass I, Division 2), CE	
Environmental	0 to +60 °C operating temp	0 to +60 °C operating temp w/o option card 0 to +50 °C operating temp w/ option card
Dimensions	Refer to Chapter 2, "Installation"	
Weight	2.0 lb.	2.25 lb.
Power Input	10-35VDC (250 mA @24VDC) (Correct polarity must be observed.)	9-35VDC, (500 mA @24VDC) with PC/104 9-35VDC, (375 mA @24VDC) without PC/104 (Correct polarity must be observed.)
Shock	15G, 11ms, half-sine	
Vibration	1G, 57 to 500 Hz	

Table 1-2. Summary of Datapanel 240E Features and Capabilities

<b>Features</b>	<b>240E</b>
Processor	AMD AM186ES-32MHz
LCD Display Size (pixels)	240x128
Database Size	128k
Backlight	CCFT
Memory, Flash	512KB Flash
Memory, SRAM or DRAM	256KB SRAM
Serial Ports	One RS232, one RS232/RS485
Standard Software Features	Touch screen, tag scaling, static and dynamic data display, alarm manager, read/write to controller, overview display, configurable function keys, downloadable database and protocol, scalable text sizes, dynamic, scalable bitmaps, downloadable fonts, meter and trend recorders, graphical drawing objects, trends, and bar charts, dynamic lines/shapes, message tables.
Bar Graphs	Yes
Bitmap Graphics	Yes
Real-Time Trends	Yes
VT100 option	Yes, option
PC/104 Expansion	Yes
Function Keys per Page	Six (The ↑↓ arrow keys can also be programmed.)
Data Entry Keypad	10 keys, 12-button popup on screen
Touch Screen	Yes, 8 x 6 matrix
Controller Protocols:	Over 80 supplied, including GE Fanuc, Modicon, Allen Bradley, Square D, Mitsubishi, Omron, Siemens, etc. Call for details
Analog Tags	500
Digital Tags (2 bits per tag)	500
Display Pages	100
NEMA, UL, CUL, CE	4X/4/12, UL (Class I, Div II), CE
Environmental	0 to +60 °C operating temp w/o option card 0 to +50 °C operating temp w/ option card
Dimensions	Refer to Chapter 2, "Installation"
Weight	2.5 lb.
Power Input	9-35VDC (500 mA @24VDC w/ PC/104) 9-35VDC, (375 mA @24VDC) without PC/104 (Correct polarity must be observed.)
Shock	15G, 11ms, half-sine
Vibration	1G, 57 to 500 Hz



# Chapter 2

## Installing the Hardware

---

---

Datapanel is housed in two molded enclosures that form the front and the rear sections of the unit. The front section of the Datapanel forms a bezel with a large central aperture giving access to the LCD display and to the membrane keypad. The Datapanel is mounted to the panel enclosure with a gasket that adheres to the inner surface of the bezel and seals the unit to its enclosure. This gasket (bezel) ensures conformity with the IP65 (NEMA 4/12) rating.

The rear section of the housing is a simple cover that fully encloses the system hardware. The two sections are secured to one another by snapping them together; the four plastic clips (one located near each corner) should fully latch to one another. The physical dimensions and the required panel cutouts are shown in Table 1H2-1.

Table 2-1. Physical Dimensions and Panel Cutouts

<b>Features</b>	<b>Model 150</b>	<b>Model 160</b>	<b>Model 240E</b>
Dimensions Inches (cm)	8.19 Wide (20.64) x 7.40 High (18.65) x 1.88 (4.74) Deep	8.19 Wide (20.64) x 7.40 High (18.65) x 2.71 (6.83) Deep	8.19 Wide (20.64) x 7.40 High (18.65) x 2.67 (6.78) Deep
Panel Cutout Inches (cm)	7.75 (19.68) W x 6.97 (17.70) H		

## Mounting Datapanel

The Datapanel comes with a gasket glued in place on the bezel to ensure compliance with protection ratings. The Datapanel is secured using miniature screw clamps. The mounting points for the clamps are located on the front section of the Datapanel. Access to the rear of the unit is necessary so that clamps can be fitted.

After positioning the Datapanel in the cutout, the unit is then secured using the spring clamps as shown in Figure 2-1. Working from the rear of the panel, the clips must be located in the slots shown in the diagram and marked A. The clamps should be tightened evenly so as to cause the nuts to rise up the screw threads and thus close the springs. It is important that the screws are not over-tightened as the springs may then be deformed resulting in an improper mounting of the Datapanel. Six clamps are used to secure the Datapanel.

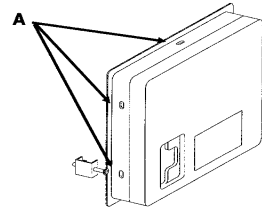

Clamp Slot Locations

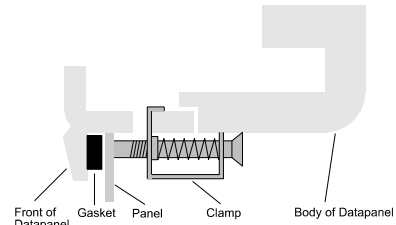

Clamp Mounting Detail

Figure 2-1. Datapanel Mounting Clamps

---

## *Connection Cables*

Two connecting cables are required when using a Datapanel:

- The download cable (IC752BCL000) enables connection to a standard PC and is used when transferring databases or protocols from the configuration software to the Datapanel. This cable is supplied with the configuration software. Pinouts are shown in Figure 2-2.

For non-standard PCs, consult the PC manual to check the pin configuration at the PC end of the cable.

- The cable used to connect Datapanel to the controller. As a general guide, the only pin connections required at the Datapanel end are Tx, Rx, Signal, Ground; with RTS connected to CTS. Refer to your controller documentation for details of connections at the controller end. This cable is not supplied with the Datapanel, however the Datapanel-to-PLC cables listed in Table 2-2 are available for purchase.

Many cable diagrams can be found in the Protocol Help section of the DataDesigner software.

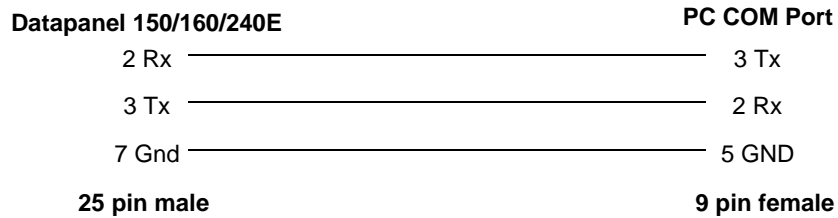

Figure 2-2. Download Cable

Table 2-2. Communication Cables for DP150, 160, 240E

<i>PLC</i>	<i>PLC Port</i>	<i>Port Type</i>	<i>Type</i>	<i>Catalog No.</i>
AB MicroLogix	Prog Port	Mini-DIN	RS-232	IC752CAB202
AB SLC-500	DH-485 Port	RJ-45	RS-485	IC752CAB201
AB SLC-500	Channel 0	9-pin D	RS-232	IC752BCL000*
GE Fanuc Series 90	SNP Port	15-pin D	RS-485	IC752CGE201
GE Fanuc Series 90	CMM Module	25-pin D	RS-232	IC752CGE202
GE Fanuc VersaMax	CPU Port 1	9-pin D	RS-232	IC752COM201
GE Fanuc VersaMax Nano/Micro	CPU Port 1	RJ-45	RS-232	IC752CGE203
Mitsubishi Fx	Prog Port	25-pin D	RS-422	IC752CMI201
Modicon 984	Modbus Port	9-pin D	RS-232	IC752CMO201
Modicon Micro	Modbus Port	RJ-45	RS-232	IC752CMO202
Omron Host	Link Port	9-pin D	RS-232	IC752COM201
Omron Host	Link Port	25-pin D	RS-232	IC752COM202
Siemens S7-200	PPI Port	9-pin D	RS-485	IC752CSI201

\* IC752BCL000 is also the download cable that is used when transferring databases or protocols from the configuration software to the Datapanel.

**Note:** Additional cable diagrams can be found in the Protocol Help provided with the DataDesigner software.

# Chapter 3

## Operation Guide

---

---

Datapanels operate in one of three modes:

**RUN** - Enables real time processes to be viewed from configured displays downloaded to the datapanel.

**EDIT** – Allows in-place editing of tags that have been configured with the editable attribute.

**OFF-LINE** - Enables the configuring of the communications port (model 150), setting the date and time, loading databases and protocols, and enabling or disabling alarm checking.

On power-up, the Datapanel enters Run Mode and begins normal operation. The Start Up page is displayed if one was specified during configuration with the configuration software. Otherwise, page 0 containing the Datapanel logo is displayed. Two lines of display are reserved for system use. The top line displays the page number, error messages for communication and tag alarms, date, and time. The bottom line displays descriptive text for the function keys. The keys shown are the default configuration. Any of the keys may be assigned other labels and functions during configuration. They may have different labels and functions on different display pages. When the keys are reprogrammed from their default value, they are often referred to as *softkeys*.

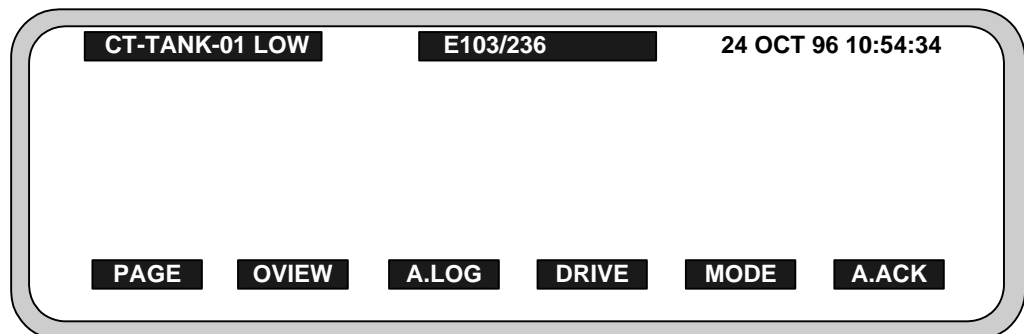

Figure 3-1. Function Keys



The default Run Mode F-keys are:

- **PAGE** - displays the first configured page. Often, the first page is configured as an index or menu of all other pages.
- **OVIEW** - displays configured overview groups.
- **A.LOG** - displays the alarm log.
- **DRIVE** - allows the operator to write to the controller.
- **MODE** - allows the operator to switch between the Run Mode and Mode Menu.
- **A.ACK** - allows the operator to acknowledge alarms.

## *Routine Processing*

For a process that is running routinely, you would likely display a page that provides a summary of process conditions. The page might include elements showing constantly updating values of parameters indicating process efficiency (e.g., cans filled per hour, gallons of fruit juice per minute, KW of electricity consumed.). If you are using a Datapanel 160 or 240E, the page could include a trend chart showing performance over some time period and a bar chart showing the availability of a critical process supply.

## *Viewing Other Pages*

Other pages provide alternate views of the operation of the process. For instance, this would be useful if you noticed a change in some parameter and you wanted more detail on that aspect of the process. You can choose another page by typing in the page number (models 150/160) and pressing  (ENTER). Alternatively, you can scroll through the pages by pressing the  $\sigma$  or  $\tau$  keys. The  $\tau$  key displays the next page; the  $\sigma$  key displays the previous page. Page 1 or the last displayed page will appear when you press **PAGE**. The Start Up page can be configured to show a list or menu of other pages. If so configured, you can use a redefined F-key to access other pages.

## *Viewing Overview Groups*

Press **OVIEW** to see a list of overview groups that are configured for your application. Each group contains a maximum of 5 configured tags that have been grouped together during configuration because they are relevant to each other, e.g., temperatures or pressures. There may be up to 100 groups. The list of groups is displayed in pages with 10 group names being listed on each page. When the **OVIEW** key is pressed, the designation and function of some of the softkeys change. For instance, one of the F-key label displays a left-chevron design (<<<) and another displays a right-chevron design (>>>).

Use <<< to move backward through the pages of the Overview list. Use >>> to move forward through the pages of the Overview list. Scroll through the pages of the Overview list until the required page is accessed. The range of Overview Groups on a particular page of the list is shown at the top of the display. Use the  $\sigma$  or  $\tau$  keys to select the required Overview Group from the displayed page. Press **TAGS** to display the tags and values associated with this group. You can return to the first page of this list at any time by pressing **OVIEW**.

### Printing a Page

If the page being displayed has **PRINT** assigned to one of the F-keys, pressing that F-key will output the text content of the page to the printer. For instance, you may want to do this at the end of a shift in order to have a permanent record of conditions at that time. Graphics on the page will not be printed.

The Datapanel Models 160 and 240E include a second port (COM2) that allows printing. Printing is possible only if the COM2 port is not already being used for multi-port communications.

### Alarm Conditions

If one of the configured tags exceeds its limits, an alarm message will appear in the alarm message area on the top line of the page and also be added to the alarm log. Press the **A.ACK** F-key to acknowledge the alarm(s).

### Displaying Alarms

Press **A.LOG** to display the Alarm Log. The capacity and display characteristics of the logs are described in "Alarm Log Characteristics" on page 3-3. If the capacity of the log is exceeded, the earlier alarms will be lost. When a tag exceeds its limits, it will remain in the Alarm Log until it has been acknowledged and returns to normal or until it has been overwritten by tags alarming at a later time in an overflowing alarm log. Unacknowledged alarms are indicated with an asterisk.

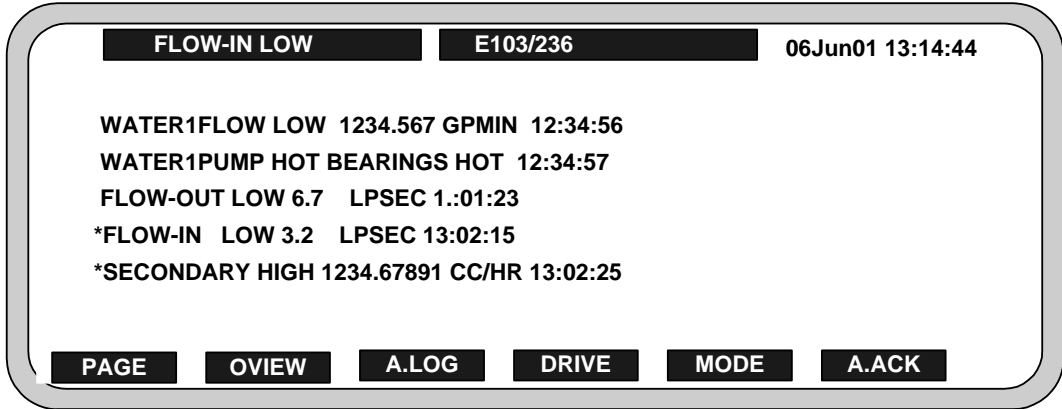

Figure 3-2. Alarm Log

### Acknowledging Alarms

Press **A.ACK** to acknowledge an alarm. The first press of the key clears the global alarm bit. Typically, this bit is sent to the controller to silence the audible alarm. Subsequent presses of the key clear each alarm in turn, starting with the earliest of the alarms. Press the  $\sigma$  or  $\tau$  keys to access other pages of the log.

**Note:** You do not need to be on the Alarm Log page to acknowledge alarms.

### Additional Alarm Information

If the Datapanel has been configured to do so, selected alarms will be printed automatically as they occur. (Models 160 and 240E include a second COM2 port that allows printing if the port is not already being used for multi-port communications.) The alarm message line shows the earliest unacknowledged alarm. The alarm message line is updated as each alarm is acknowledged. When all alarms have been acknowledged, the alarm message line is removed until another alarm condition occurs.

The **A.LOG** function key is displayed only if alarms are enabled. If the alarms were configured as disabled or have been disabled in the Off-line option, the **A.LOG** and **A.ACK** function keys will be displayed blank.

Table 3-1. Alarm Log Characteristics

	<b>Models 150, 160</b>	<b>Model 240E</b>
Alarm Capacity	50	50
Alarms/Page	5	10
Mini Alarm Log	10 characters of tag name	10 characters of tag name
ACK method	* in ACK symbol column means not acknowledged	* in ACK symbol column means not acknowledged
<b>Analog Alarms</b>		
1 <sup>st</sup> Column	ACK symbol	ACK symbol
2 <sup>nd</sup> Column	10 characters of tag name	10 characters of tag name
3 <sup>rd</sup> Column	4 characters of alarm type	4 characters of alarm type
4 <sup>th</sup> Column	11 characters of value	10 characters of value
5 <sup>th</sup> Column	5 characters of units	5 characters of units
6 <sup>th</sup> Column	8 characters of time	8 characters of time
<b>Digital Alarms</b>		
1 <sup>st</sup> Column	ACK symbol	ACK symbol
2 <sup>nd</sup> Column	10 characters of tag name	10 characters of tag name
3 <sup>rd</sup> Column	4 characters of alarm type	4 characters of alarm type
4 <sup>th</sup> Column	16 characters of status	16 characters of status
5 <sup>th</sup> Column	Not used	not used
6 <sup>th</sup> Column	8 characters of time	8 characters of time

## Drive Out

The Drive key activates the Drive Out function, which provides Write operations to the controllers based on index numbers assigned to each tag to be written. This capability can also be programmed on other function keys, along with other types of operations. For more information, refer to the *DataDesigner User's Manual*, GFK-1658.

## *Edit Mode*

The following procedures describe how to use the Datapanel on-screen edit mode to edit tag displays that have the Editable attribute.

### *Datapanel 240E*

1. To begin the on-screen edit mode, press the Enter key.
2. Press the arrow keys to move the cursor to different editable on-screen tags, then press the Enter key again to select the tag to edit. The keypad pops up on the screen.
3. Use the keypad, which displays numbers for editing numeric tags and alpha characters for editing text tags, to edit the tag display.
4. Press the Enter key to accept the new tag value (or text).
5. Press any other key to end the Edit.

To cancel Edit without changing the existing value (or text), use the Backspace key to blank the entry box, then press Enter. You can also end the edit by pressing the ESC key on the keypad.

### *Datapanel 150/160*

1. To begin the on-screen edit mode, press the Enter key.
2. Press the arrow keys to move cursor to different on screen tags.
3. Using the numeric keypad, enter the new value. (For on-screen editing of text tags, a numeric key must be pressed to display the alpha characters in the function key label area.)
4. Press CR to accept the new value.

To cancel Edit without changing the existing value (or text), use the Backspace key to blank the entry box, then press Enter.



# Chapter 4

## Special Operations: Mode Menu

---

---

The Mode menu is normally not used during routine operation of the Datapanel. It allows the operator to display information about the Datapanel, change the attributes of the display, or operate the Datapanel in the off-line mode. Press the MODE key during the Run mode to display the Mode Menu.

**Note:** While the Mode menu is displayed, Controller communications are still active.

**Note:** The FAULT button appears only if GE Fanuc SNP/SNP-X (protocol 68) is configured.

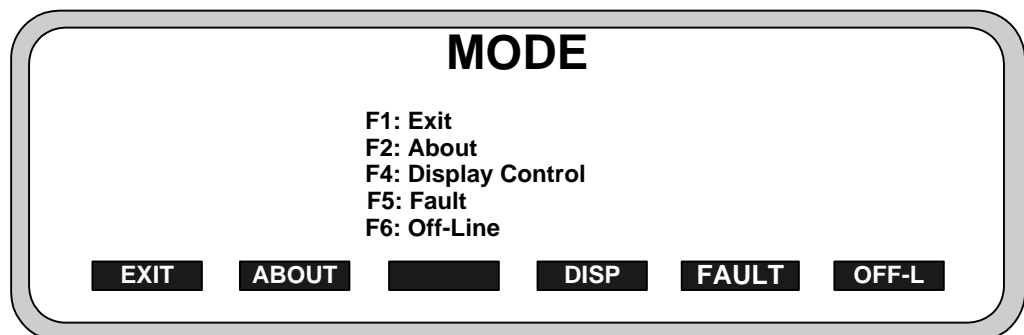

Figure 4-1. Mode Menu

### *Exit*

Press **EXIT** to return to the startup page.

### *About Menu*

Press **ABOUT** to display information about the Datapanel software, database, and protocol. This information cannot be edited.

On the Datapanel 150 or 240E, press **MORE** to display the configuration of the port settings. On the 240E, press **PORT** to select port 1 or port 2.

On the Datapanel 160, press **PORTS** to display the configuration of the port settings. On the DP160, press **PRTCL** to display information about protocols configured for and loaded for ports 1 and 2.

Press **EXIT** to return to the main Mode menu.

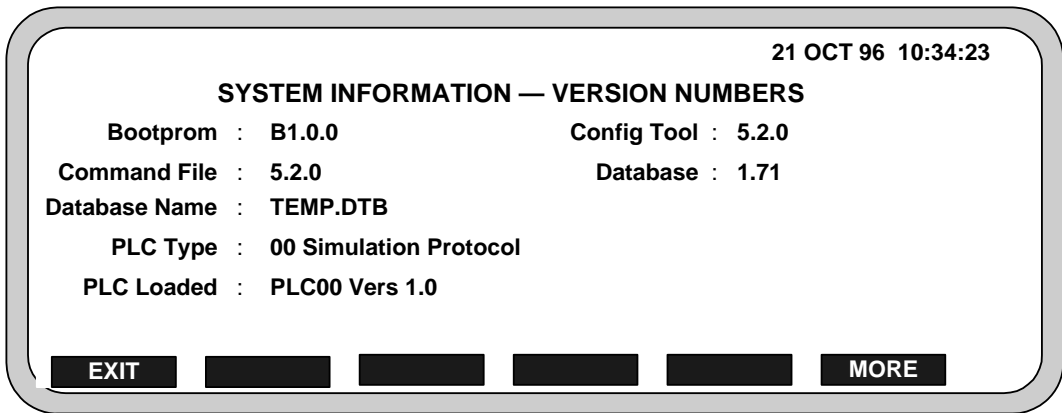

Figure 4-2. About Menu (DP150)

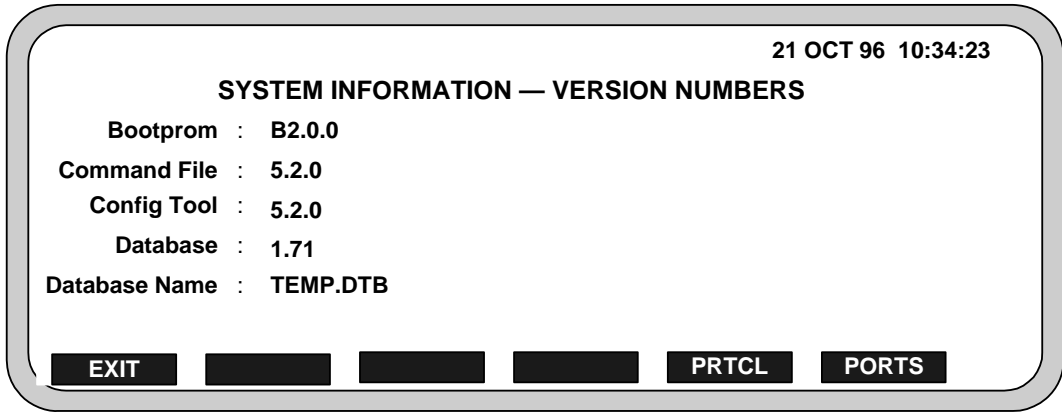

Figure 4-3. About Menu (DP160)

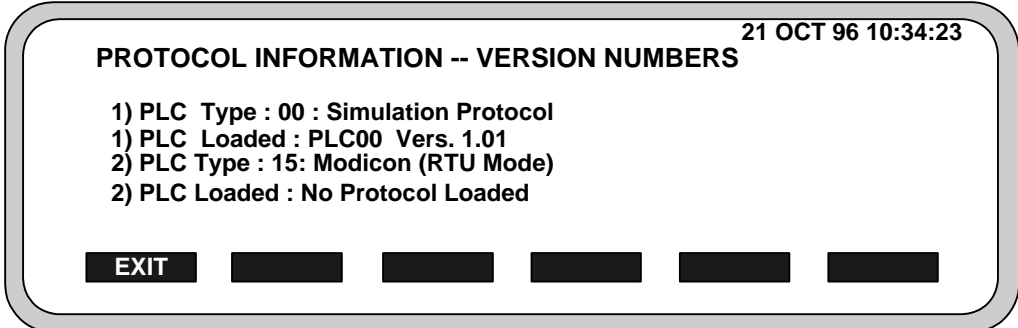

Figure 4-4. Protocol Menu (DP160)

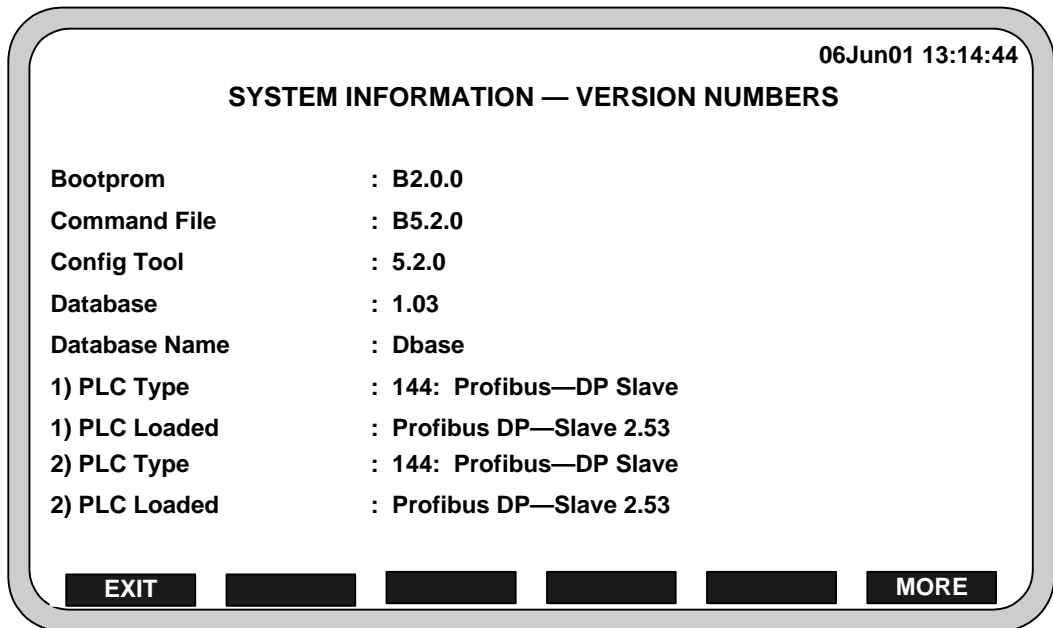

Figure 4-5. About Menu (DP240E)

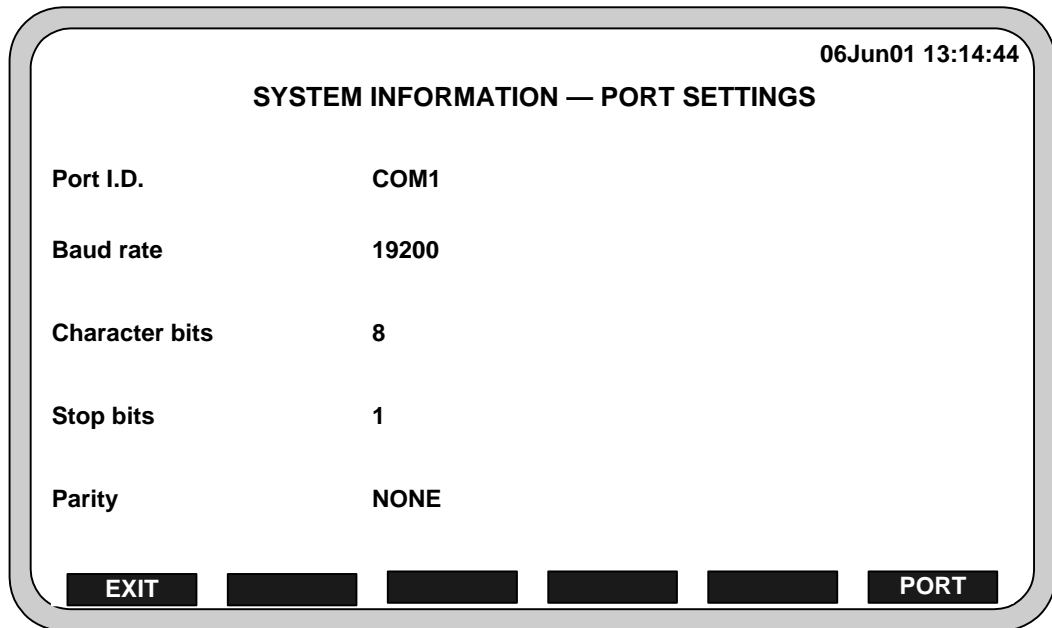

Figure 4-6. Port Settings Menu (DP240E)



## Display Control Menu

In the Mode menu, press **DISP** to view the Display Control Menu.

### Models 150/160

This menu allows the operator to change the display contrast setting, switch the backlight on or off, and set the backlight timer. Unless the backlight is configured OFF using the configuration software, the default is ON.

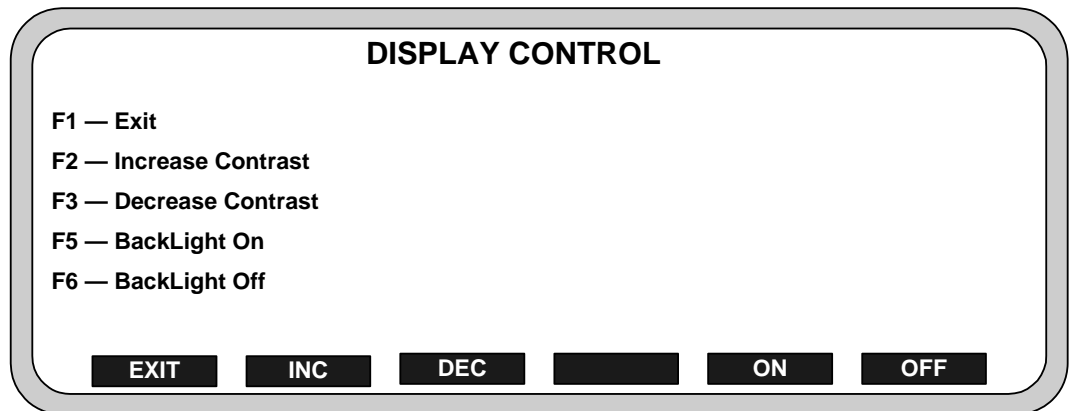

Figure 4-7. Display Control Menu for 150/160

Press **INC** repeatedly to increase the contrast to the desired level.

Press **DEC** repeatedly to decrease the contrast to the desired level.

Press **ON** to turn the display backlight on.

The prompt **Enter delay period in minutes** appears.

If you want the display to be turned off after a period of inactivity, enter a number within the range of 0 to 99 minutes. If the Datapanel keyboard is inactive longer than this period the display will be turned off. The display will be turned back on when any key is pressed. If zero is entered, the backlight will remain on at all times. Enter the time period using the numeric keypad.

Press **OFF** to turn the backlight off. If the backlight is not needed, it should be turned off to conserve power and extend the life of the backlight LED.

Press **EXIT** to return to the main Mode menu.

## Model 240E

This menu allows the operator to change the display contrast setting.

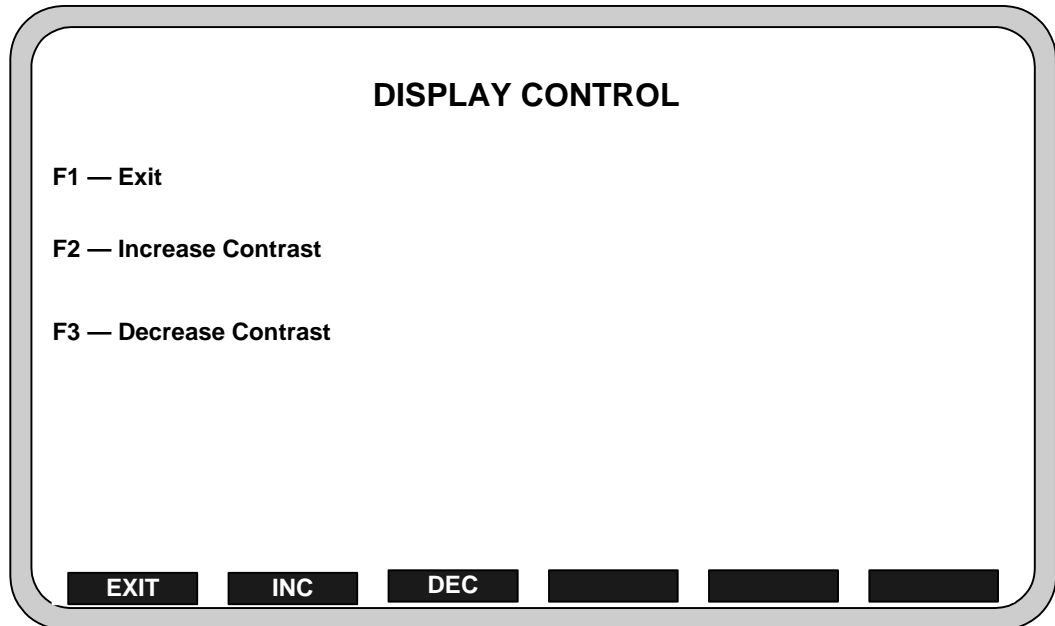

Figure 4-8. Display Control Menu for 240E

Press **INC** repeatedly to increase the contrast to the desired level.

### Caution

Turning on the backlight when ambient temperatures are below 10°C (50°F) significantly shortens the life expectancy of the backlight components. In applications that repeatedly encounter temperatures of 10°C (50°F) or below, the backlight should be left on continuously. In applications exposed to temperatures above 10°C (50°F), the backlight should be set to turn off after an hour of inactivity with the keys or touch. It is also recommended that the Datapanel never be powered up in ambient temperatures of less than 0°C (32°F) or above 60°C (140°F).

Press **DEC** repeatedly to decrease the contrast to the desired level.

For Model 240E, the backlight is always on. For Models 150 and 160, the timer is either on or off and has a period of 1 hour. The backlight timer is controlled only through the DataDesigner software. If the backlight is not needed, the timer should be turned on to conserve power and extend the life of the backlight LED or fluorescent tube, **unless the Datapanel is in an environment where temperatures reach 10°C (50°F) or below.**

Press **EXIT** to return to the main Mode menu.



If **DIAG** is pressed, the Fault Code and Fault Data lines appear. These provide more detailed fault codes that can be referenced by technical support.

Other function keys at the bottom of the screen include: **RUNST**, which changes to the Set PLC State page; **IOFLT**, which changes to the I/O Faults page; and **EXIT**, which returns to the **MODE** screen. If write privileges are enabled, the fifth function key will be labeled **CLEAR**. Pressing it will clear the PLC fault log in the PLC. If the PLC is password protected, the user will be prompted for a Level 2 SNP password.

## I/O Fault Screen

The I/O Fault Screen displays the I/O Faults log in the PLC.

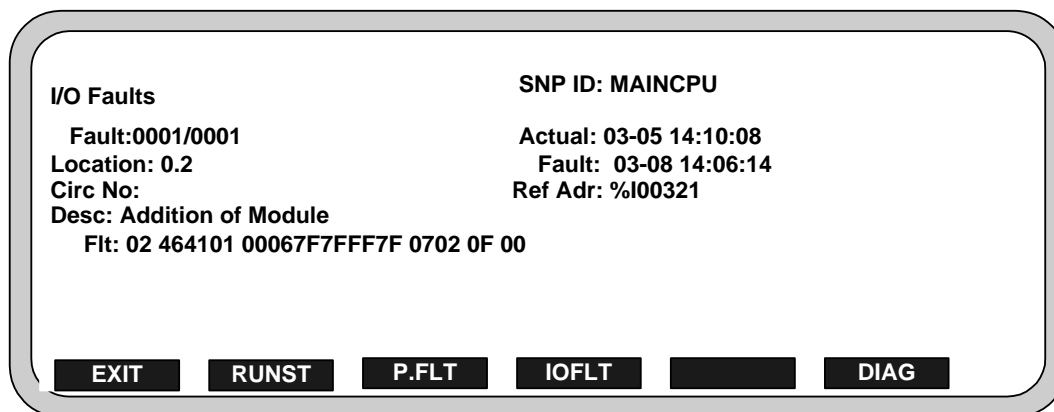

Figure 4-10. PLC I/O Faults Screen

The fields are similar to those in the PLC Faults screen.

**Circ No** is the point on a multi-point card, such as digital input 4 of a 16-pt module. **Ref Adr** provides the PLC table mapping of the card.

## Set PLC State

This screen allows the user to view and modify the PLC's run-state.

The screenshot shows a rectangular screen with a rounded border. At the top left, it says 'Set PLC State' and at the top right, 'SNP ID: MAINCPU'. Below this, there are two lines of text: 'Current Mode: Run Mode, I/O enabled.' and 'New Mode: Run Mode, I/O enabled.'. At the bottom, there are six buttons arranged horizontally: 'EXIT', 'UPDAT', 'R.ENB', 'R.DIS', 'S.DIS', and 'S.ENB'.

Figure 4-11. PLC Run/Stop Mode Screen

**Current Mode** states the present mode of the PLC. **New Mode** will change to reflect the last button the user pressed from four mode options.

**R.ENB** changes the new mode to Run Mode, I/O enabled.

**R.DIS** (only available for certain PLC models) changes the new mode to Run Mode, I/O disabled.

**S.DIS** changes the new mode to Stop Mode, I/O disabled.

**S.ENB** changes the new mode to Stop Mode, I/O enabled.

**UPDAT** is only available if write permissions have been set in the PC Configuration tool. Pressing update will attempt to change the current mode to the new mode selected. If the PLC is password protected, the operator will be prompted for a Level 2 SNP password. Successful operation is marked by the current mode changing to the new setting.

**EXIT** returns to the PLC or I/O Fault screen.

## Off-Line Mode

The **Off-line** mode enables the operator to configure the communications port (model 150 only), set the date and time, load databases and protocols, and enable or disable alarm checking. When the Off-Line option is accessed, all controller communications and alarms are inactive and the alarm message line is not displayed. The clock is not displayed but is running as a background task.

This function is usually password protected at the time of configuration. If so, when Off-Line is attempted, a prompt is displayed asking for the password. The correct password must be entered in response to the prompt. An incorrect password aborts the attempt to go off-line.

Press **OFF-L**, while in the Mode main menu, to go off-line and display the Off-Line Mode menu shown in Figure 4-12. When finished, Press **EXIT** to return to the main Mode menu. The system will revert to the main Mode Menu, but communications will not start until Run Mode is accessed by pressing **EXIT**. The clock and the alarm message line will again appear.

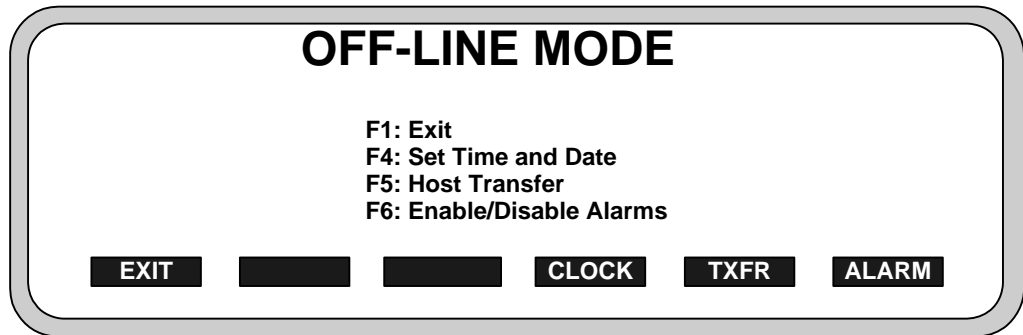

Figure 4-12. Off-Line Mode Menu for 160/240E

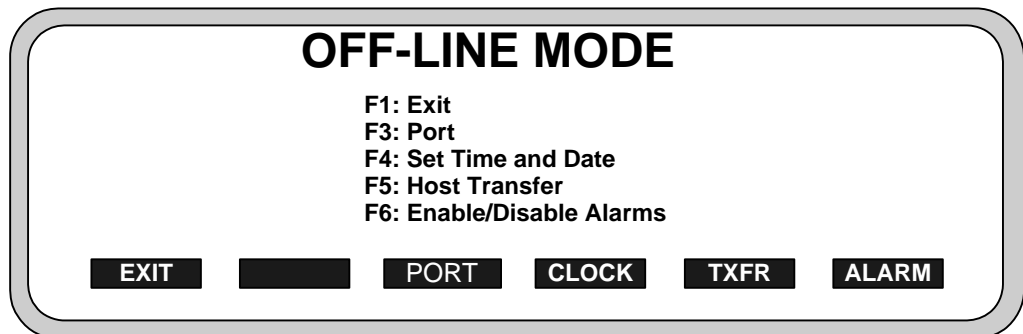

Figure 4-13. Off-Line Mode Menu for Model 150

### Configure Serial Port (Model 150 Only)

Press **PORT** to display the Set Communications Port Menu. This option also enables the display and modification of the configured settings for Port COM1. When finished, press **EXIT** to return to the Off-Line Mode menu.

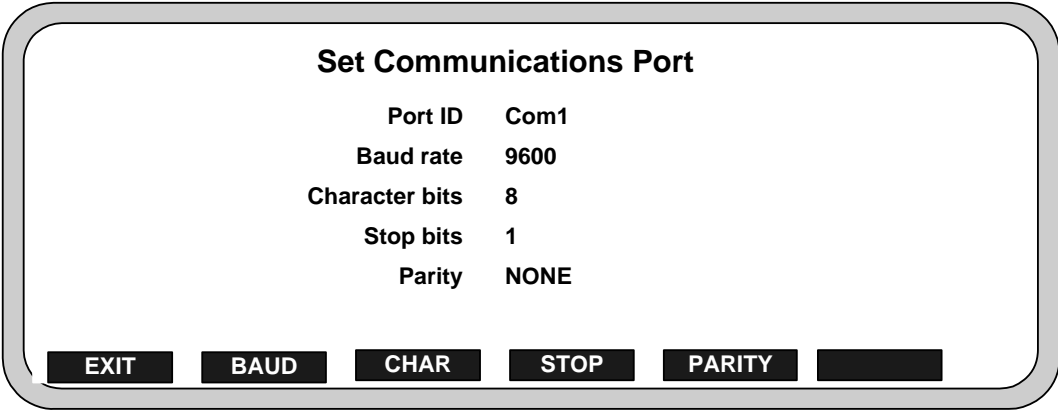

Figure 4-14. Set Ports Menu for Model 150

Press **BAUD** to scroll through the available baud rates to select the desired rate.  
Press **CHAR** to toggle between 7 and 8 to select the desired number of character bits.  
Press **STOP** to toggle between 1 and 2 to select the desired number of stop bits.  
Press **PARITY** to scroll through the available parity choices to select the desired parity.  
Press **EXIT** to return to the Off-Line Mode menu.

### Set Time and Date Display

Press **CLOCK** to display the Set Clock menu.

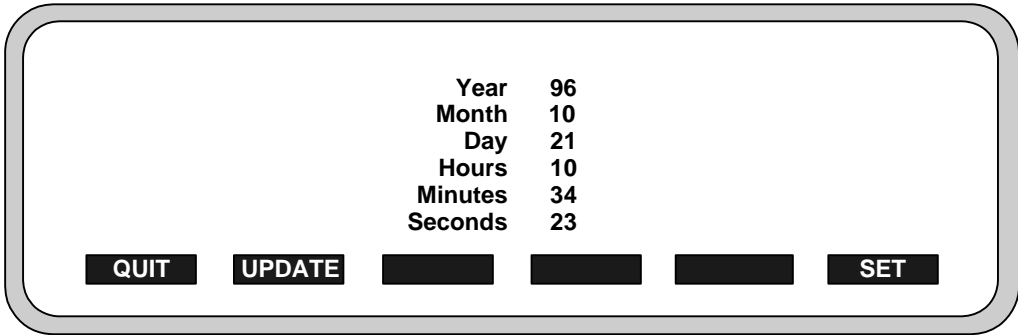

Figure 4-15. Set Clock Menu

Press the up-down arrow keys ( $\sigma$   $\tau$ ) to move from field to field on the display. Using the numeric keypad, type in the desired values for the field, press  $\text{↵}$ .  
Press **QUIT** to halt the option and return to the main Off-Line Menu without changing the clock settings.

Press **UPDATE** to confirm the entries, update the clock, and return to the main Off-Line Menu.

Model 240E only: Press **SET** to bring up the on-screen numeric keypad.

## Host Transfer

Press **TXFR** to access the Host Transfer display and enable data transfer between the Datapanel and the configuration software PC. To exit the transfer, press **ABORT**

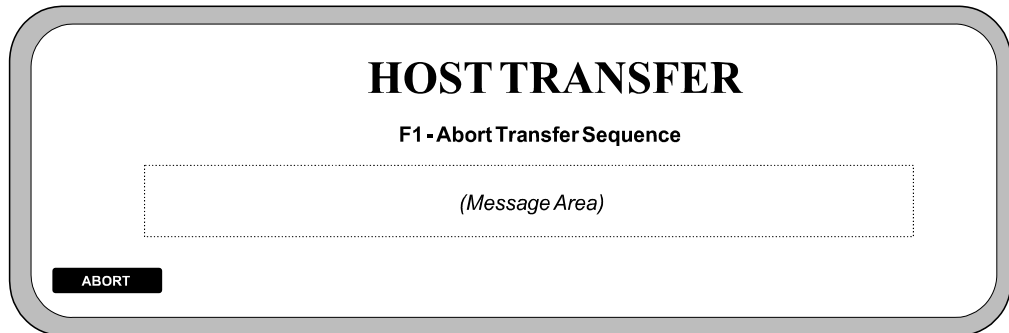

Display for Host Transfer

Figure 4-16. Host Transfer Display

The actual transfer of the data is under the control of the PC. The following messages will be displayed in the message area of the display:

*When downloading a Protocol:*

**Loading Communications Protocol ...**  
and on the same line when complete, **Protocol installed.**

*When downloading a Database:*

**Loading Database ...**  
and on the same line when complete, **Database installed.**

*When uploading a Database:*

**Uploading Database ...**  
and on the same line when complete, **Database transferred.**

*When a communications error occurs:*

**Transfer Failed**

## Enable/Disable Alarms

Press **ALARM** to access the alarm option. The label of one of the F-keys will change to **ENABLE**, another will change to **DISABLE**. Press **ENABLE** to enable alarms. Press **DISABLE** to disable alarms. Press **EXIT** to return to the Off-Line Menu. This option is useful to prevent excessive alarm logging during periods of operation with known process discrepancies or during process testing.





# Chapter 5

## Specifications

### Hardware Specifications

#### Display

Text can be displayed in a variety of sizes by changing the height and width of the text. The default size is displayed with a height and width of 1 x 1 (see table below for pixel relationships). This can be increased so that text of 6 x 6 size can be configured. Two lines of the display are reserved for system use. The top line displays the date and time and any communications errors or tag alarms. The bottom line displays descriptive text for the function keys. Datapanel display area and display characteristics are specified in Table 5-1.

Table 5-1. Display Area and Characteristics

<b>Features</b>	<b>Models 150, 160</b>	<b>Model 240E</b>
LCD Display Size (pixels)	240x64	240 x 128
(mm)	124 x 35 mm	119.4 x 63.5
(in.)	(4.88 x1.38 in.)	(4.7 x 2.5)
Display capability with minimum text size	40 char 6 lines	40 char 14 lines
Minimum Text Size (pixels)	6w x 8h	6w x 8h

The Model 240E has a resistive touch membrane overlaid on the display area. The membrane is divided into rows and columns that provide touch regions which can be configured by the user.

#### Backlight

The backlight type is given in Table 5-2.

On Datapanel models 150/160, the backlight of the display can be switched ON or OFF. Operation of the backlight is defined during configuration by the configuration software. In addition, the operator can control the backlight using the membrane key pad from the Mode menu.

On Datapanel model 240E, the backlight cannot be switched off. It can be configured using DataDesigner software to go off after 1 hour of inactivity with the keys or touchscreen, otherwise, it is on.

Caution
---------

For Datapanel 240E, turning on the backlight when ambient temperatures are below 10°C (50°F) significantly shortens the life expectancy of the backlight components. In applications that repeatedly encounter temperatures of 10°C (50°F) or below, the backlight should be left on continuously. In applications exposed to temperatures above 10°C (50°F), the backlight should be set to turn off after an hour of inactivity with the keys or touchscreen.

Table 5-2. Backlight Type

<i>Features</i>	<i>Models 150, 160</i>	<i>Model 240E</i>
Backlight	LED	CCFT

## Keypad

All Datapanel models incorporate built-in membrane keypads with audible feedback.

Table 5-3. Keypad Characteristics

<i>Features</i>	<i>Models 150, 160</i>	<i>240E</i>
Function Keys per Page	Six	Six
Data Entry Keypad	22 keys	10 keys
Touch Screen	No	Yes 8 x 6 touch regions

The top row of keys are the function keys required for the operation of the system. They match the keys displayed on the bottom line of the display. The remaining keys enable the input of numerical values. The Backspace key is used to edit keyboard entries before pressing Enter.

On Model 240E, the use of a resistive overlay allows a much simpler membrane keypad, with the resistive touch areas being configured for most of the operator keying functions. Numerical keys are provided by a pop-up window on-screen keypad.

## LED Indicators

The front panel contains four LED indicators. From left to right, these are: Power, Status, Receive, and Transmit.

## *Technical Specifications*

The technical specifications are given in Table 5-4.

Table 5-4. Technical Specifications

<b>Features</b>	<b>Model 150</b>	<b>Model 160</b>	<b>Model 240E</b>
Processor	AMD AM188EM-20 MHz	AMD AM186ES-32 MHz	AMD AM186ES-32 MHz
Memory, Flash	512KB Flash	512KB Flash	512KB Flash
Memory, SRAM or DRAM	128KB SRAM	256KB SRAM	256KB SRAM
Database Size	64K	64K	128K
Serial Ports	One RS232/485	One RS232/485 One RS232	One RS232/485 One RS232
Additional Ports	No	PC/104	PC/104

## Electrical Specifications

**Note:** Power lines should be kept short to minimize inductance. High inductance (greater than 1mH) in the power lines or DC power supply may cause the Datapanel to not power up properly.

A short 12AWG wire should be used from pin 3 of the power supply connector to frame ground (earth).

## Power Requirements

### Caution

**The Datapanel product is a low power Class 2 circuitry device. Input power exceeding 35V may cause permanent damage.**

The power requirements are given in Table 5-5. The steady state current consumption of the Datapanel is dependent on the supply voltage. At power-up, the Datapanel briefly requires a larger current to operate correctly. To ensure correct power-up, the external power supply must be able to provide a current of at least 1A for model 150 and 2A for model 160/240E, irrespective of the supply voltage.

The power for the Datapanel can be supplied either through the 4-pin power connector or through pins 14—17 on the 25-pin connector. However, pins 14—17 are intended only as a secondary power input option for end-users wishing to supply power from the controller. It is recommended that power be supplied via the dedicated input connector.

Correct polarity of the DC power input must be observed. If the polarity is backward, the unit will not be damaged but will not power up.

Table 5-5. Power Requirements

<b>Features</b>	<b>Model 150</b>	<b>Models 160/240E</b>
Power input	10-35VDC, 600mA typical @ 24VDC (Correct polarity must be observed.)	9-35VDC, 1.2A typical @ 24VDC with PC/104 9-35VDC, 375mA typical @ 24VDC without PC/104 (Correct polarity must be observed.)
Minimum current for startup	1A	2A

## Ports and Pinouts

Ports and Pinouts for the Datapanel Models 150 and 160/240E are shown below.

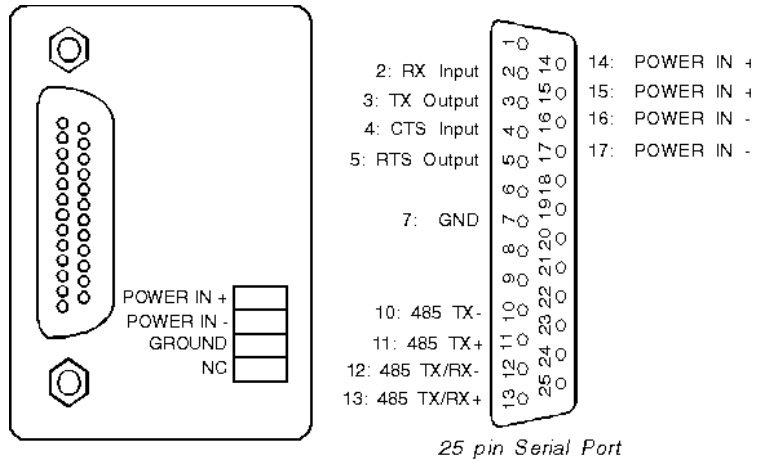

Figure 5-1. Model 150 Ports and Pinouts

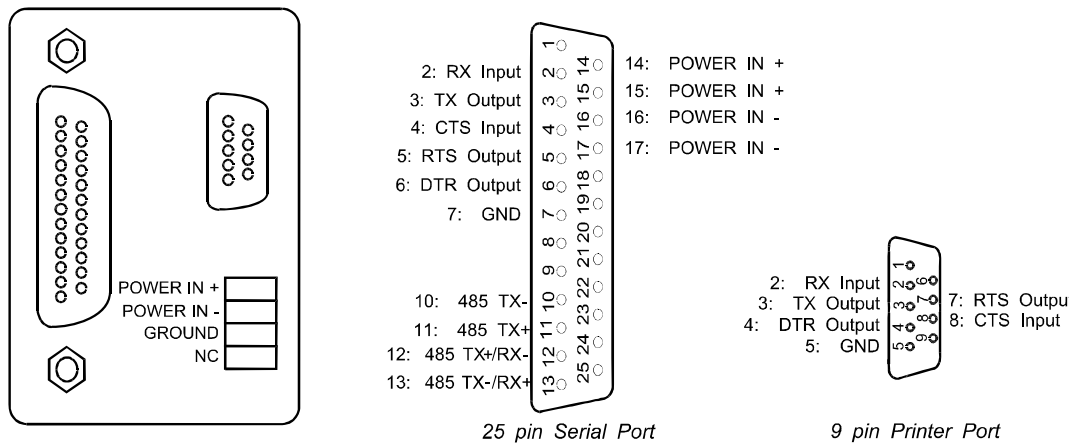

Figure 5-2. Models 160 and 240E Ports and Pinouts

## Data Retention

Data retention characteristics are given in Table 5-6.

Table 5-6. Data Retention Characteristics

<b>Model 150</b>	<b>Models 160/240E</b>
No backup is provided. The System Software, protocols and database are all stored using the 512 Kbytes of Flash memory.	Backup is provided for SRAM by the use of a lithium energy cell integrated within the Real-Time Clock circuit (not user replaceable). The System Software, protocols and database are all stored using the 512 Kbytes of Flash memory.
	<p>Battery Life</p> <p>Typical: 10 years</p> <p>Worst: 5 years</p> <p>The battery life figures constitute total "off-time." For a Datapanel powered on half-time, the estimated battery life would be at least 10 years.</p>

## ***Real-Time Clock***

Real-time clock characteristics are given in Table 5-7.

Table 5-7. Real-Time Clock Characteristics

<b><i>Datapanel 150</i></b>	<b><i>Datapanel 160/240E</i></b>
None	±1 minute/month

## ***Environmental Conformity***

Environmental conformity is given in Table 5-8.

Table 5-8. Environmental Conformity

Model 150	4/4X/12 UL (Class 1, Div 2), CE
Model 160	4/4X/12 UL (Class 1, Div 2), CE
Model 240E	4/4X/12 UL, CUL, (Class 1, Div 2), CE

All units in the Datapanel Range remained operational when tested for temperature, humidity and vibration to the specifications shown in Table 5-9.

Table 5-9. Test Specifications

	<b><i>Datapanel 150</i></b>	<b><i>Datapanel 160/240E</i></b>
Operating Temperature	0 to +60 °C (32 to 140 °F)	0 to +60 °C without PC/104 option card (32 to 140 °F) 0 to +50 °C with PC/104 option card (32°F to 122°F)
Storage Temperature	-20 to +70°C (-4 to 158 °F)	-20 to +70 °C (-4 to 158 °F)
Humidity	5 to 85 % non-condensing	5 to 85 % non-condensing
Vibration	1G, 57 to 500Hz	1G, 57 to 500Hz
Shock	15G, 11ms, half-sine	15G, 11ms, half-sine

## ***Networking with Datapanel***

Models 150, 160, and 240E can be configured to network to a number of controllers on an RS-485 network, providing only one Datapanel is acting as communication Master on the network. More than one Master on a network cannot be used. The controller must also be operating on the network.





***Standard Comms Block Error Codes***

101	Timeout
102	Checksum Received Error
103	Bad Character Received Format Error
104	Bad Message Framing Error
105	Bad Message Format Received
106	NAK Response Received
107	Comms Block Format Error
108	Invalid Command

***Controller Errors***

If any errors are displayed which are not listed in the above tables, reference should be made to the configuration software Help system or to the controller documentation.



## A

- About menu, 4-1
- Acknowledging alarms, 3-3
- Additional alarm information, 3-3
- Alarm conditions, 3-3
- Alarms
  - enable/disable, 4-11

## B

- Backlight
  - controlling, 4-4
  - operating temperatures, 4-4, 5-1
  - specifications, 5-1

## C

- Cables
  - Datapanel-to-PLC, 2-3
  - download, 2-3
- Checksum Error message, 1-2
- Clock
  - accuracy, 5-7
  - battery, 5-6
  - setting, 4-10
- Configuration software, 1-2
- Configuring
  - PLC fault screen options, 4-6

## D

- Data retention, 5-6
- Datapanels
  - feature summary, 1-4
  - features and capabilities, 1-5
  - mounting, 2-2
  - overview, 1-1
- Display
  - backlight, 5-1
  - specifications, 5-1
- Display Control menu, 4-4
- Displaying alarms, 3-3
- Download cable, 2-3
- Drive Out, 3-4

## E

- Edit mode, 3-5
- Enable/disable alarms, 4-11
- Environmental conformity, 5-7
- Error Codes, A-1

## H

- Hardware specifications, 5-1
- Host transfer, 4-11

## I

- Industrial housing, 1-2
- Installation, 2-1

## K

- Keypad, 5-2

## L

- LED Indicators, 5-2

## M

- Mode menu, 4-1
- Mounting Datapanels, 2-2
- Multidrop
  - configuration, 4-6

## N

- Networking, 5-7

## O

- Off-Line mode, 4-9
- Operation
  - modes, 3-1

## P

- PC104 expansion, 1-3
- Physical characteristics, 2-1
- Pinouts, 5-5
- PLC fault screens, 4-6
- PLC state
  - setting, 4-8
- Ports and pinouts, 5-5
- Printing a page, 3-3

## R

- Real-time clock, 5-7
- Routine processing, 3-2

## S

- Serial ports configure, 4-10
- Set time and date display, 4-10
- Special operations, 4-1
- Specifications, 5-1
  - backlight, 5-1
  - display, 5-1
  - keypad, 5-2
  - LED indicators, 5-2
  - technical, 5-3
- System components, 1-2

## T

- Tags
  - editing tag displays in Datapanel edit mode, 3-5
- Technical specifications, 5-3

## V

- Viewing other pages, 3-2
- Viewing overview groups, 3-2



## Artisan Technology Group is your source for quality new and certified-used/pre-owned equipment

- FAST SHIPPING AND DELIVERY
- TENS OF THOUSANDS OF IN-STOCK ITEMS
- EQUIPMENT DEMOS
- HUNDREDS OF MANUFACTURERS SUPPORTED
- LEASING/MONTHLY RENTALS
- ITAR CERTIFIED SECURE ASSET SOLUTIONS

### SERVICE CENTER REPAIRS

Experienced engineers and technicians on staff at our full-service, in-house repair center

### *InstraView*<sup>SM</sup> REMOTE INSPECTION

Remotely inspect equipment before purchasing with our interactive website at [www.instraview.com](http://www.instraview.com) ↗

### WE BUY USED EQUIPMENT

Sell your excess, underutilized, and idle used equipment. We also offer credit for buy-backs and trade-ins. [www.artisanng.com/WeBuyEquipment](http://www.artisanng.com/WeBuyEquipment) ↗

### LOOKING FOR MORE INFORMATION?

Visit us on the web at [www.artisanng.com](http://www.artisanng.com) ↗ for more information on price quotations, drivers, technical specifications, manuals, and documentation

**Contact us:** (888) 88-SOURCE | [sales@artisanng.com](mailto:sales@artisanng.com) | [www.artisanng.com](http://www.artisanng.com)