



## Artisan Technology Group is your source for quality new and certified-used/pre-owned equipment

- FAST SHIPPING AND DELIVERY
- TENS OF THOUSANDS OF IN-STOCK ITEMS
- EQUIPMENT DEMOS
- HUNDREDS OF MANUFACTURERS SUPPORTED
- LEASING/MONTHLY RENTALS
- ITAR CERTIFIED SECURE ASSET SOLUTIONS

### SERVICE CENTER REPAIRS

Experienced engineers and technicians on staff at our full-service, in-house repair center

### *InstraView*<sup>SM</sup> REMOTE INSPECTION

Remotely inspect equipment before purchasing with our interactive website at [www.instraview.com](http://www.instraview.com) ↗

### WE BUY USED EQUIPMENT

Sell your excess, underutilized, and idle used equipment. We also offer credit for buy-backs and trade-ins. [www.artisanng.com/WeBuyEquipment](http://www.artisanng.com/WeBuyEquipment) ↗

### LOOKING FOR MORE INFORMATION?

Visit us on the web at [www.artisanng.com](http://www.artisanng.com) ↗ for more information on price quotations, drivers, technical specifications, manuals, and documentation

**Contact us:** (888) 88-SOURCE | [sales@artisanng.com](mailto:sales@artisanng.com) | [www.artisanng.com](http://www.artisanng.com)

# *Model TC-202A*

---

## *Bipolar/Monopolar*

---

### *Temperature Controller*

---

#### *User's Manual*

---

*Model TC-202A Bipolar/Monopolar Temp. Controller 65-0045*  
*Model TC-202AM Bipolar/Monopolar Temp. Controller 65-0046*



**HARVARD**  
A P P A R A T U S

# Table of Contents

| SUBJECT                                     | PAGE  |
|---|-------|
| Warranty and Repair Information .....       | 2     |
| Specifications .....                        | 3     |
| Introduction .....                          | 4-5   |
| Setting Up the TC-202A .....                | 6     |
| Front Panel Connectors and Controls .....   | 7     |
| Operation .....                             | 8     |
| Troubleshooting .....                       | 9     |
| Appendixes.....                             | 10-12 |
| Appendix A: I/O Connectors .....            | 10    |
| Appendix B: PDMI-2/PSMI Wiring Color Codes  | 10    |
| Appendix C: Voltage and Fuse Settings ..... | 11    |
| Appendix D: Rack Mounting the TC-202A ..... | 12    |

# Warranty and Repair Information

4

Harvard Apparatus TC-202A Bipolar/Monopolar Temperature Controller User's Manual

## Serial Numbers

All inquiries concerning our product should refer to the serial number of the unit. Serial numbers are located on the rear of the chassis.

## Calibrations

All electrical apparatus is calibrated at rated voltage and frequency.

## Warranty

Harvard Apparatus warrants this instrument for a period of one year from date of purchase. At its option, Harvard Apparatus will repair or replace the unit if it is found to be defective as to workmanship or material.

This warranty does not extend to damage resulting from misuse, neglect or abuse, normal wear and tear, or accident.

This warranty extends only to the original customer purchaser.

**IN NO EVENT SHALL HARVARD APPARATUS BE LIABLE FOR INCIDENTAL OR CONSEQUENTIAL DAMAGES.** Some states do not allow exclusion or limitation of incidental or consequential damages so the above limitation or exclusion may not apply to you. **THERE ARE NO IMPLIED WARRANTIES OF MERCHANTABILITY, OR FITNESS FOR A PARTICULAR USE, OR OF ANY OTHER NATURE.** Some states do not allow this limitation on an implied warranty, so the above limitation may not apply to you.

If a defect arises within the one-year warranty period, promptly contact *Harvard Apparatus, Inc. 84 October Hill Road, Building 7, Holliston, Massachusetts 01746-1371* using our toll free number 1-800-272-2775. Goods will not be accepted for return unless an RMA (returned materials authorization) number has been issued by our customer service department. The customer is responsible for shipping charges. Please allow a reasonable period of time for completion of repairs, replacement and return. If the unit is replaced, the replacement unit is covered only for the remainder of the original warranty period dating from the purchase of the original device.

This warranty gives you specific rights, and you may also have other rights which vary from state to state.

## Repair Facilities and Parts

Harvard Apparatus stocks replacement and repair parts. When ordering, please describe parts as completely as possible, preferably using our part numbers. If practical, enclose a sample or drawing. We offer a complete reconditioning service.

## CAUTION

This temperature controller is not registered with the FDA and is not for clinical use on human patients.



CAUTION: Not for clinical use on human patients.

## TC-202A Specifications

|                                  |   |
|----------------------------------|---|
| <b>Temperature Setting Range</b> | 0° to 50°C  |
| <b>Temperature Regulation</b>    | ±0.2°C  |
| <b>Temperature Display</b>       | ±0.1°C  |
| <b>Chamber Temp. Sensor</b>      | Thermilinear type, 36 K, nominal at 25°C  |
| <b>Voltage Range</b>             | 0 to ±5 V   |
| <b>Current Range</b>             | 0 to ±6 A DC (sustained)  |
| <b>Dimensions</b>                | 48.3 cm x 8.9 cm x 33.7 cm (19" x 3.5" x 13.25")  |
| <b>Weight</b>                    | 5.7 kg (12.5 lb)  |
| <b>Power; AC Fuse</b>            | 150 W; (2 fuses) 1 Amp @ 120 V, (2 fuses) 0.5 Amps (slow blow) @ 220 V (see use settings) |
| <b>AC Supply Voltage</b>         | 115 VAC, 60 Hz; 220 VAC, 50 Hz (user selectable) (see volt settings)                      |

The following refer to use with the PDMI-2 micro-incubator and a Corning™ Petri dish as chamber, mounted on a Nikon DiaPhot™ (inverted) microscope. A top cover is placed over the dish; no gas flow is being used, media depth in the dish is 4 mm.

### TEMPERATURE STABILITY

| <b>Plate Control:</b> | <b>Bath Temperature</b> | <b>Perfusion Rate</b> | <b>Stability</b> |
|-----------------------|-------------------------|-----------------------|------------------|
|                       | 37 °C                   | 0 ml/min              | +/- 0.2 °C       |
|                       | 37 °C                   | 2 ml/min              | +/- 0.8 °C       |
|                       | 15 °C                   | 0 ml/min              | +/- 0.2 °C       |
|                       | 15 °C                   | 2 ml/min              | +/- 0.4 °C       |
| <b>Bath Control:</b>  | <b>Bath Temperature</b> | <b>Perfusion Rate</b> | <b>Stability</b> |
|                       | 37 °C                   | 0 ml/min              | +/- 0.1/ °C      |
|                       | 37 °C                   | 2 ml/min              | +/- 0.1/ °C      |
|                       | 15 °C                   | 0 ml/min              | +/- 0.1/ °C      |
|                       | 15 °C                   | 2 ml/min              | +/- 0.1/ °C      |

### TEMPERATURE CHANGE TIME (10-90%) – 25°C TO 37°C

| <b>Plate Control:</b> | <b>Perfusion Rate</b> | <b>Time</b> |
|-----------------------|-----------------------|-------------|
|                       | 0 ml/min              | 8.25 min    |
|                       | 2 ml/min              | 12.0 min    |
| <b>Bath Control:</b>  | <b>Perfusion Rate</b> | <b>Time</b> |
|                       | 0 ml/min              | 8.5 min     |
|                       | 2 ml/min              | 7.0 min     |

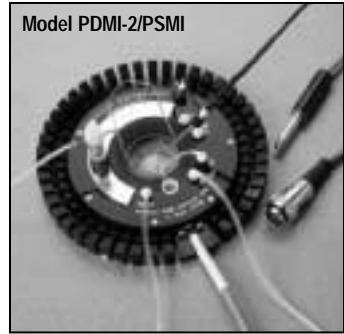
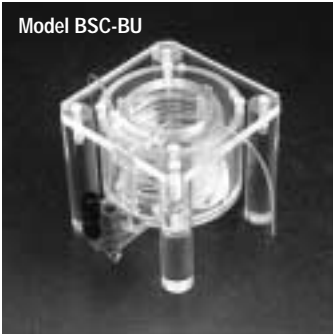

The Bipolar/Monopolar Temperature Controller (Model TC-202A) is designed to be used with several micro-incubators supplied by Harvard Apparatus Inc. These models include the Open Perfusion Micro-Incubator (Model PDMI-2), Patch Slice Micro-Incubator (Model PSMI), Leiden Static Micro-Incubator (Model LU-CB1) Leiden Closed Perfusion Micro-Incubator (Model LU-CPC-CEH) and Brain/Tissue Slice System (Model BSC-BU).

A micro-incubation system from Harvard Apparatus consists of the Temperature Controller (TC-202A), a micro-incubator (one of the above) of choice, a 35 mm plastic Petri dish or reusable cover slip dish (LU-CSD, MSC-TD or MSC-PTD) and an associated pumping system. Such a system allows complete environmental conditioning along with excellent micro-mechanical access for electrodes or micropipettes, all with optimum optical access.







A proportional temperature controller is basically a source of electric current whose magnitude is determined by comparing a desired target temperature with its current value. The TC-202A's output is proportional to the difference in temperature between the desired and the current value. This type of system avoids the electrical noise of suddenly turning current on and off, unlike less expensive controllers. When using the TC-202A in the Biphasic mode, the current will spontaneously reverse direction when the current temperature is too high; in short, it can also cool when used with Peltier elements. (PDMI-2/PSMI)



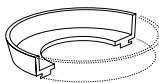
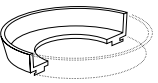

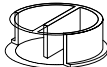
The TC-202A features two complementary temperature controlling options:

1. The chamber temperature can be controlled using the supplied thermistor (BSC-T3). This option allows the desired chamber temperature to be dialed directly on the SET control. This option has the advantage of better stability of temperature over time allowing faster change of temperature. (See Specifications, page 3)
2. The temperature can be controlled with the internal thermistor (PDMI-2 and PSMI only). (The connection to this internal thermistor is made through the integral multi-conductor cable. This internal thermistor measured the temperature driven plate of the devices; the incoming perfusate is heated or cooled by this plate. This mode of operation prevents the chamber overheating or over-cooling should the 'bath' thermistor become dislodged from the tissue media. The temperature of this Peltier plate, however, will be 3 - 5 °C difference from room temperature than the chamber itself. (See Specifications, page 3)

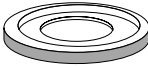
| Model LU-CSD  | Model LU-CSD Special  |
|---|---|
|  Teflon Dish                   |  Teflon Dish                   |
|  Silicon Rubber Ring           |  Multi Well                    |
|  Glass Coverslip               |  Silicon Rubber Ring           |
|  Stainless Steel Securing Ring |  Glass Coverslip               |
|   |  Stainless Steel Securing Ring |

# Setting Up the TC-202A

8

Use with the PDMI-2, PSMI or CSMI (Peltier Type Chambers)

This section describes the electrical connections between the PDMI-2, PSMI or CSMI and the TC-202A. To connect the 6 pin cable plug into the "I/O" Jack on the front panel of the TC-202A. The A magnetic base thermistor holder for the bath thermistor is secured mechanically onto the chrome plated ferrous metal ring on the top black plastic cover. This thermistor is plugged into the "Bath Sensor" inlet of the TC-202A.

Before powering the unit on for the first time:

1. Check that the TC-202A has been set to the proper AC line voltage (110 VAC, 60 Hz; 220 VAC, 50 Hz) on the rear panel.
2. Insure that the switch on the rear panel of the temperature controller is factory preset for the type of chamber Peltier or resistive heater type, that is shipped with the TC-202A.



CAUTION: If the temperature controller and the chamber are purchased separately, please set the rear panel chamber type selector for the correct chamber before use.

Use with Other Peltier Devices

The TC-202A can possibly be used with custom Peltier based temperature controlled chamber other than PDMI-2 and PSMI-2.

Use with (Resistive Heater) Micro-Incubators

The TC-202A can be used with resistive heater micro-incubators such as the Leiden Static Micro-Incubator (Model LU-CB1) Leiden Closed Perfusion Micro-Incubator (Model LU-CPC-CEH) and Brain/Tissue Slice System (Model BSC-BU). A switch on the rear panel of the temperature controller is factory preset for the type of chamber Peltier or resistive heater type, that is shipped with the TC-202A. For details of each micro-incubator, refer to the specific micro-incubator's user manuals.



CAUTION: If the temperature controller and the chamber are purchased separately, please set the rear panel chamber type selector for the correct chamber before use.



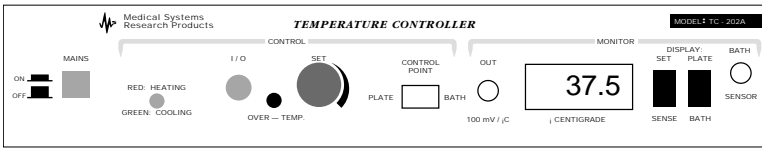

## Power

This push button on/off switch for main power glows red when on. Push again to turn off.  
Red: Heating / Green: Cooling Indicator

This lamp indicates whether the temperature controller is heating or cooling the peltier chamber at the moment.

## I/O

This multi-pin panel jack accepts a matching plug from a chamber cable. It includes inputs from the PDMI-2's, PSMI's or CSMI's internal temperature sensor (thermistor), current output to drive the heat pumping and ground connections. Pin-out is given in APPENDIX A.

*Note: LUCBI, LUCPCEH, BSC-BU chambers are shipped with a cable that can be disconnected at the chamber and as well as at the TC-202A panel. These chambers do not have a 'plate thermistor' and should always be used with a bath thermistor as the control point.*

## Over-Temp

This lamp indicates when the TC-202A's output current has been temporarily disabled because the PDMI-2's or PSMI's temperature driven plate has exceeded 50°C. (See Troubleshooting Section, page 9).

## Set

This allows setting of the desired target temperature. Turn clockwise for higher temperature, counterclockwise for lower temperature. Push the set/sense switch. The target temperature will be displayed on the LCD.

## Control Point

This switch selects the regulation (control) point: either the chamber (bath) or the internal temperature driven plate (PDMI-2, PSMI and CSMI only). Plate control is safer if shallow media depths are being used with perfusion (perhaps for rapid change of media) where slight irregularities in flow rate may uncover the (otherwise) controlling thermistor.

*Note: When using the TC-202A in monopolar the plate control will be disabled or will not have any effect on the BSC-BU; LU-CBI, or LU-CPC-CEH micro-incubators and temperature can be controlled only when the bath thermistor is in the chamber.*

## Out BNC Panel Connector

This electrical output monitors either the (bath) or plate temperature (depending on the position of the DISPLAY switch). This is useful for monitoring temperature change protocols with a computer or strip chart. The scaling factor is 100 mV/o C.

## Centigrade

This 3.5 digit digital display gives the temperature selected by the two DISPLAY switches.

## Display

This switch selects temperature source for display. The switch on left is spring-loaded so it sits at SENSE. It reads the current temperature sensed by either the chamber (BATH) thermistor (BSC-T3) or the plate thermistor inside the PDMI-2, PSMI or CSMI. In SET position the digital display reflects set point target temperature as commanded by SET control. The switch on the right selects temperature sense location being displayed: BATH or PLATE.

## Bath Sensor

This 1/4 inch phone jack accepts the BATH (chamber) thermistor - BSC-T3. Use BSC-T3A (short version) with LUCPC-CEH chamber.

## PDMI-2, PSMI and CSMI

The following assumes that a complete micro-incubation system (TC-202A, micro-incubator and chamber) has already been setup with appropriate interconnections (see Specifications section on page 3). (If being used with the PDMI-2/PSMI, see the Setup and Operation section in the PDMI-2, PSMI or CSMI manuals for setup details.)

First practice operation without perfusion (or cells/tissue) in the attached micro-incubator (PDMI-2, etc.) and chamber to allow you to better focus on the controller's operation. Try plate control first: set the DISPLAY to PLATE. Hold the SET/SENSE switch to SET while adjusting the SET dial to a temperature about 3 - 4o C above (heating) or below (cooling) the desired chamber temperature. Release the SET/SENSE switch and switch the DISPLAY to BATH. You may wish to connect a strip chart recorder to OUT for a record of the approach of the chamber temperature to the set value.

Repeat the previous run with bath control. Switch back and forth between PLATE and BATH display during this run: the plate temperature may actually overshoot with the HEATING/COOLING lamp temporarily reversing.

Finally, try continuous perfusion. With perfusion the initial temperature changes will occur faster but the final approach to the set point may take longer due to the extra loading of the TC-202A.

These practice runs should give a basis for deciding whether to use PLATE or BATH control as well as allow fine tuning of procedures. If PLATE control is used, allow for manual fine tuning of the chamber temperature: the exact temperature difference between plate and chamber depends on media perfusion rate (recommended @ 2 ml/min.) , gas flow rate (recommended @ 2 ml/min.), media depth, the presence or absence of a top cover, and the mounting details on the microscope.

If being used for electrophysiological measurements, PLATE control should be selected for lowest noise: the bath thermistor must be removed from the bath to avoid excessive transfer of noise signals to the recording electrode. Prior measurement of the temperature difference between plate and bath for the chosen perfusion conditions and media depth can be done to enable the chamber to be held at the desired temperature.

## Monophasic (Resistive Heater) Micro-Incubators

The following assumes that a complete micro-incubation system (TC-202A, micro-incubator and chamber) has already been setup with appropriate interconnections.

First practice operation without perfusion (or cells/tissue) in the attached micro-incubator (LU-CB1, etc.) and chamber to allow you to better focus on the controller's operation. Set the CONTROL POINT switch to the BATH setting. Hold the SET/SENSE switch to SET while adjusting the SET dial to a temperature about 37°C. Release the SET/SENSE switch and switch the DISPLAY switch to BATH. You may wish to connect a strip chart recorder to OUT for a record of the approach of the chamber temperature to the set value.

The following assumes the TC-202A is being used with the Open Perfusion Micro-Incubator (PDMI2).

Display Reads 0.00:

If this continues to happen despite the supply of heating/cooling current (indicated by the red/green panel lamp), then the BATH (chamber) thermistor isn't plugged in.

No Change in Temperature:

If this continues to happen despite the apparent supply of heating/cooling current, either the PDMI-2 or its cable has a discontinuity in electrical connection. Measure the electrical resistance between pins 1 and 4 of the jack from the micro-incubator. It should be 0.5 - 1.0 ohms.

Temperature Calibration is Off:

The sealed BATH thermistor (BSC-T3) is defective. If its electrical resistance between the tip and ring of the jack at ambient 25°C temperature is much different than 36 Kohms, then it should be replaced. This is better tested with the thermistor in water, since one failure mode is the development of a leak. This will show up as a much lower resistance.

Negative Bath Temperature:

This also is due to a defective bath thermistor. Its electrical resistance between tip and ring of the jack is probably infinite.

Negative Plate Temperature: (PDMI-2, PSMI and CSMI only)

This can happen normally during a change in temperature for a short time caused by overshoot of the plate temperature during BATH (chamber) control. If it continues to read negative, check the electrical resistance between pins 3 and 6 of the PDMI-2 cable at ambient temperature. If infinite or much greater than 100 Kohms, then the PDMI-2 should be returned for replacement of the internal thermistor.

Over-Temp:

If the plate temperature goes above 75 °C, then the TC-202A stops delivering current and this panel light goes on until the temperature returns to safe values. This likely due to "feedforward" failure of the Peltier devices inside the micro-incubator. No damage has been done to the micro-incubator or the TC-202A. See TROUBLESHOOTING in the specific micro-incubator manual for suggested changes in operating procedure to avoid this in the future.

| Pin | Function  |
|-----|---|
| 1   | Peltier chamber power output, + when heating, - if cooling.       |
| 2   | Resistive Heater chamber Power Output                             |
| 3   | Thermistor input from temperature driven plate of PDMI-2 or PSMI. |
| 4   | (Connected together in the jack) -Chamber Power Ground.           |
| 5   | (Connected together in the jack) -Chamber Power Ground.           |
| 6   | Thermistor input from temperature driven plate of PDMI-2 or PSMI. |

## Appendix B: Wiring PDMI-2, PSMI and CSMI Color Codes

From the first release to the market of the PDMI-2, PSMI and CSMI Micro-Incubators to the current design, there have been various design changes. A wiring color code of the different units released is provided below to aid the wiring of the PDMI-2, PSMI or CSMI cable to the chosen temperature controller's power/control output. In the current version, the PDMI-2, PSMI or CSMI is provided with a connector which matches the TC-202A output connector. For other options the table below may be used. In any case, we suggest that you contact Harvard Apparatus, Inc. for instructions or more details.

### PDMI-2, PSMI and CSMI Cable Wiring

| Main Cable                  | Wire Size | Original | Temp        | Pin Out   | Final                |
|-----------------------------|-----------|----------|-------------|-----------|----------------------|
| Peltier +                   | AWG 20    | Red      | White       | Pin 1 & 2 | Red                  |
| Power Ground                | AWG 20    | Black    | Black       | Pin 4 & 5 | Black                |
| Peltier Plates              | AWG 26    | Green    | Green       | Shield    | Green                |
| Thermistor                  | AWG 26    | Blue     | Transparent | Pin 6     | White                |
| Thermistor                  | AWG 26    | Brown    | Red         | Pin 3     | Green                |
| Fin Jacks                   | Wire Size | Original | Temporary   | Pin Out   | Final                |
| Ground (1mm)                | AWG 26    | N/A      | N/A         | N/A       | Green Pin Jack       |
| Signal ground (salt bridge) | AWG 26    | White    | White       | N/A       | White Pin Jack (1mm) |

1. Make sure the power cord is NOT connected to the power entry module (PEM) in the back of the TC-202A.
2. Using a small flat screw driver, open the door or cover of power entry module by prying at the groove on top.
3. Pull voltage selector drum out and rotate to AC line voltage which will be used. 100-200-220-240.

*Note: Do not rotate drum while inside of power entry module, center pins will break.*

4. To replace the fuses: Pull out fuse drawer and snap off the two fuses. Replace with fuses and reassemble the fuse drawer in to the power entry module. Make sure arrows in fuse drawer (if any) are pointing to the same direction.

*Note: Make sure you have proper fuse rating for AC line voltage selected.*

Example:

100 - 120 VAC - 1 amp - slow blow (2)

220 - 240 VAC - .5 amp - slow blow (2)

5. Close by snapping power entry module door, making sure AC line voltage selected can be seen through the window of door.

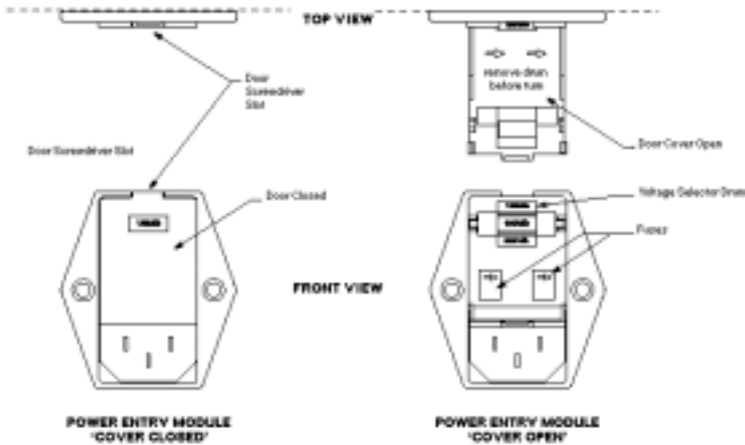



**CAUTION:**

Turn power OFF before attaching mounting bracket.

1. Place unit on a hard flat surface with front facing towards you.
2. Remove three screws on either side of the unit.
3. Position the mounting bracket over the screw holes as shown below.
4. Insert the three screws and fully tighten with a suitable screwdriver.
5. Repeat step four on the other side of the unit.
6. Insert the unit into the 19 inch rack and screw with suitable screws (not provided).

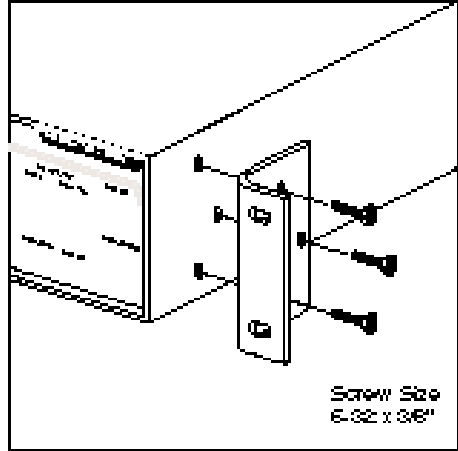



## Artisan Technology Group is your source for quality new and certified-used/pre-owned equipment

- FAST SHIPPING AND DELIVERY
- TENS OF THOUSANDS OF IN-STOCK ITEMS
- EQUIPMENT DEMOS
- HUNDREDS OF MANUFACTURERS SUPPORTED
- LEASING/MONTHLY RENTALS
- ITAR CERTIFIED SECURE ASSET SOLUTIONS

### SERVICE CENTER REPAIRS

Experienced engineers and technicians on staff at our full-service, in-house repair center

### *InstraView*<sup>SM</sup> REMOTE INSPECTION

Remotely inspect equipment before purchasing with our interactive website at [www.instraview.com](http://www.instraview.com) ↗

### WE BUY USED EQUIPMENT

Sell your excess, underutilized, and idle used equipment. We also offer credit for buy-backs and trade-ins. [www.artisanng.com/WeBuyEquipment](http://www.artisanng.com/WeBuyEquipment) ↗

### LOOKING FOR MORE INFORMATION?

Visit us on the web at [www.artisanng.com](http://www.artisanng.com) ↗ for more information on price quotations, drivers, technical specifications, manuals, and documentation

**Contact us:** (888) 88-SOURCE | [sales@artisanng.com](mailto:sales@artisanng.com) | [www.artisanng.com](http://www.artisanng.com)