



## Artisan Technology Group is your source for quality new and certified-used/pre-owned equipment

- FAST SHIPPING AND DELIVERY
- TENS OF THOUSANDS OF IN-STOCK ITEMS
- EQUIPMENT DEMOS
- HUNDREDS OF MANUFACTURERS SUPPORTED
- LEASING/MONTHLY RENTALS
- ITAR CERTIFIED SECURE ASSET SOLUTIONS

### SERVICE CENTER REPAIRS

Experienced engineers and technicians on staff at our full-service, in-house repair center

### *InstraView*<sup>SM</sup> REMOTE INSPECTION

Remotely inspect equipment before purchasing with our interactive website at [www.instraview.com](http://www.instraview.com) ↗

### WE BUY USED EQUIPMENT

Sell your excess, underutilized, and idle used equipment. We also offer credit for buy-backs and trade-ins. [www.artisanng.com/WeBuyEquipment](http://www.artisanng.com/WeBuyEquipment) ↗

### LOOKING FOR MORE INFORMATION?

Visit us on the web at [www.artisanng.com](http://www.artisanng.com) ↗ for more information on price quotations, drivers, technical specifications, manuals, and documentation

**Contact us:** (888) 88-SOURCE | [sales@artisanng.com](mailto:sales@artisanng.com) | [www.artisanng.com](http://www.artisanng.com)

**KEITHLEY**

DDA-08/16

User's Guide



A GREATER MEASURE OF CONFIDENCE

# WARRANTY

## Hardware

Keithley Instruments, Inc. warrants that, for a period of one (1) year from the date of shipment (3 years for Models 2000, 2001, 2002, 2010 and 2700), the Keithley Hardware product will be free from defects in materials or workmanship. This warranty will be honored provided the defect has not been caused by use of the Keithley Hardware not in accordance with the instructions for the product. This warranty shall be null and void upon: (1) any modification of Keithley Hardware that is made by other than Keithley and not approved in writing by Keithley or (2) operation of the Keithley Hardware outside of the environmental specifications therefore.

Upon receiving notification of a defect in the Keithley Hardware during the warranty period, Keithley will, at its option, either repair or replace such Keithley Hardware. During the first ninety days of the warranty period, Keithley will, at its option, supply the necessary on site labor to return the product to the condition prior to the notification of a defect. Failure to notify Keithley of a defect during the warranty shall relieve Keithley of its obligations and liabilities under this warranty.

## Other Hardware

The portion of the product that is not manufactured by Keithley (Other Hardware) shall not be covered by this warranty, and Keithley shall have no duty of obligation to enforce any manufacturers' warranties on behalf of the customer. On those other manufacturers' products that Keithley purchases for resale, Keithley shall have no duty of obligation to enforce any manufacturers' warranties on behalf of the customer.

## Software

Keithley warrants that for a period of one (1) year from date of shipment, the Keithley produced portion of the software or firmware (Keithley Software) will conform in all material respects with the published specifications provided such Keithley Software is used on the product for which it is intended and otherwise in accordance with the instructions therefore. Keithley does not warrant that operation of the Keithley Software will be uninterrupted or error-free and/or that the Keithley Software will be adequate for the customer's intended application and/or use. This warranty shall be null and void upon any modification of the Keithley Software that is made by other than Keithley and not approved in writing by Keithley.

If Keithley receives notification of a Keithley Software nonconformity that is covered by this warranty during the warranty period, Keithley will review the conditions described in such notice. Such notice must state the published specification(s) to which the Keithley Software fails to conform and the manner in which the Keithley Software fails to conform to such published specification(s) with sufficient specificity to permit Keithley to correct such nonconformity. If Keithley determines that the Keithley Software does not conform with the published specifications, Keithley will, at its option, provide either the programming services necessary to correct such nonconformity or develop a program change to bypass such nonconformity in the Keithley Software. Failure to notify Keithley of a nonconformity during the warranty shall relieve Keithley of its obligations and liabilities under this warranty.

## Other Software

OEM software that is not produced by Keithley (Other Software) shall not be covered by this warranty, and Keithley shall have no duty or obligation to enforce any OEM's warranties on behalf of the customer.

## Other Items

Keithley warrants the following items for 90 days from the date of shipment: probes, cables, rechargeable batteries, diskettes, and documentation.

## Items not Covered under Warranty

This warranty does not apply to fuses, non-rechargeable batteries, damage from battery leakage, or problems arising from normal wear or failure to follow instructions.

## Limitation of Warranty

This warranty does not apply to defects resulting from product modification made by Purchaser without Keithley's express written consent, or by misuse of any product or part.

## Disclaimer of Warranties

EXCEPT FOR THE EXPRESS WARRANTIES ABOVE KEITHLEY DISCLAIMS ALL OTHER WARRANTIES, EXPRESS OR IMPLIED, INCLUDING WITHOUT LIMITATION, ALL IMPLIED WARRANTIES OF MERCHANTABILITY AND FITNESS FOR A PARTICULAR PURPOSE. KEITHLEY DISCLAIMS ALL WARRANTIES WITH RESPECT TO THE OTHER HARDWARE AND OTHER SOFTWARE.

## Limitation of Liability

KEITHLEY INSTRUMENTS SHALL IN NO EVENT, REGARDLESS OF CAUSE, ASSUME RESPONSIBILITY FOR OR BE LIABLE FOR: (1) ECONOMICAL, INCIDENTAL, CONSEQUENTIAL, INDIRECT, SPECIAL, PUNITIVE OR EXEMPLARY DAMAGES, WHETHER CLAIMED UNDER CONTRACT, TORT OR ANY OTHER LEGAL THEORY, (2) LOSS OF OR DAMAGE TO THE CUSTOMER'S DATA OR PROGRAMMING, OR (3) PENALTIES OR PENALTY CLAUSES OF ANY DESCRIPTION OR INDEMNIFICATION OF THE CUSTOMER OR OTHERS FOR COSTS, DAMAGES, OR EXPENSES RELATED TO THE GOODS OR SERVICES PROVIDED UNDER THIS WARRANTY.



Keithley Instruments, Inc.

28775 Aurora Road • Cleveland, Ohio 44139 • 440-248-0400 • Fax: 440-248-6168  
1-888-KEITHLEY (534-8453) • [www.keithley.com](http://www.keithley.com)

Sales Offices:	BELGIUM:	Bergensesteenweg 709 • B-1600 Sint-Pieters-Leeuw • 02-363 00 40 • Fax: 02/363 00 64
	CHINA:	Yuan Chen Xin Building, Room 705 • 12 Yumin Road, Dewai, Madian • Beijing 100029 • 8610-6202-2886 • Fax: 8610-6202-2892
	FINLAND:	Tietäjäsentie 2 • 02130 Espoo • Phone: 09-54 75 08 10 • Fax: 09-25 10 51 00
	FRANCE:	3, allée des Garays • 91127 Palaiseau Cédex • 01-64 53 20 20 • Fax: 01-60 11 77 26
	GERMANY:	Landsberger Strasse 65 • 82110 Germering • 089/84 93 07-40 • Fax: 089/84 93 07-34
	GREAT BRITAIN:	Unit 2 Commerce Park, Brunel Road • Theale • Berkshire RG7 4AB • 0118 929 7500 • Fax: 0118 929 7519
	INDIA:	Flat 2B, Willocrissa • 14, Rest House Crescent • Bangalore 560 001 • 91-80-509-1320/21 • Fax: 91-80-509-1322
	ITALY:	Viale San Gimignano, 38 • 20146 Milano • 02-48 39 16 01 • Fax: 02-48 30 22 74
	JAPAN:	New Pier Takeshiba North Tower 13F • 11-1, Kaigan 1-chome • Minato-ku, Tokyo 105-0022 • 81-3-5733-7555 • Fax: 81-3-5733-7556
	KOREA:	2FL., URI Building • 2-14 Yangjae-Dong • Seocho-Gu, Seoul 137-888 • 82-2-574-7778 • Fax: 82-2-574-7838
	NETHERLANDS:	Postbus 559 • 4200 AN Gorinchem • 0183-635333 • Fax: 0183-630821
	SWEDEN:	c/o Regus Business Centre • Frosundavägs Allé 15, 4tr • 169 70 Solna • 08-509 04 679 • Fax: 08-655 26 10
	SWITZERLAND:	Kriesbachstrasse 4 • 8600 Dübendorf • 01-821 94 44 • Fax: 01-820 30 81
	TAIWAN:	1FL., 85 Po Ai Street • Hsinchu, Taiwan, R.O.C. • 886-3-572-9077 • Fax: 886-3-572-9031

# **DDA-08/16**

## **User's Guide**

Revision B - March 1999  
Part Number: 78340

The following safety precautions should be observed before using this product and any associated instrumentation. Although some instruments and accessories would normally be used with non-hazardous voltages, there are situations where hazardous conditions may be present.

This product is intended for use by qualified personnel who recognize shock hazards and are familiar with the safety precautions required to avoid possible injury. Read and follow all installation, operation, and maintenance information carefully before using the product. Refer to the manual for complete product specifications.

If the product is used in a manner not specified, the protection provided by the product may be impaired.

The types of product users are:

**Responsible body** is the individual or group responsible for the use and maintenance of equipment, for ensuring that the equipment is operated within its specifications and operating limits, and for ensuring that operators are adequately trained.

**Operators** use the product for its intended function. They must be trained in electrical safety procedures and proper use of the instrument. They must be protected from electric shock and contact with hazardous live circuits.

**Maintenance personnel** perform routine procedures on the product to keep it operating properly, for example, setting the line voltage or replacing consumable materials. Maintenance procedures are described in the manual. The procedures explicitly state if the operator may perform them. Otherwise, they should be performed only by service personnel.

**Service personnel** are trained to work on live circuits, and perform safe installations and repairs of products. Only properly trained service personnel may perform installation and service procedures.

Keithley products are designed for use with electrical signals that are rated Installation Category I and Installation Category II, as described in the International Electrotechnical Commission (IEC) Standard IEC 60664. Most measurement, control, and data I/O signals are Installation Category I and must not be directly connected to mains voltage or to voltage sources with high transient over-voltages. Installation Category II connections require protection for high transient over-voltages often associated with local AC mains connections. Assume all measurement, control, and data I/O connections are for connection to Category I sources unless otherwise marked or described in the Manual.

Exercise extreme caution when a shock hazard is present. Lethal voltage may be present on cable connector jacks or test fixtures. The American National Standards Institute (ANSI) states that a shock hazard exists when voltage levels greater than 30V RMS, 42.4V peak, or 60VDC are present. **A good safety practice is to expect that hazardous voltage is present in any unknown circuit before measuring.**

Operators of this product must be protected from electric shock at all times. The responsible body must ensure that operators are prevented access and/or insulated from every connection point. In some cases, connections must be exposed to potential human contact. Product operators in these circumstances must be trained to protect themselves from the risk of electric shock. If the circuit is capable of operating at or above 1000 volts, **no conductive part of the circuit may be exposed.**

Do not connect switching cards directly to unlimited power circuits. They are intended to be used with impedance limited sources. NEVER connect switching cards directly to AC mains. When connecting sources to switching cards, install protective devices to limit fault current and voltage to the card.

Before operating an instrument, make sure the line cord is connected to a properly grounded power receptacle. Inspect the connecting cables, test leads, and jumpers for possible wear, cracks, or breaks before each use.

When installing equipment where access to the main power cord is restricted, such as rack mounting, a separate main input power disconnect device must be provided, in close proximity to the equipment and within easy reach of the operator.

For maximum safety, do not touch the product, test cables, or any other instruments while power is applied to the circuit under test. ALWAYS remove power from the entire test system and discharge any capacitors before: connecting or disconnecting cables or jumpers, installing or removing switching cards, or making internal changes, such as installing or removing jumpers.

Do not touch any object that could provide a current path to the common side of the circuit under test or power line (earth) ground. Always make measurements with dry hands while standing on a dry, insulated surface capable of withstanding the voltage being measured.



The instrument and accessories must be used in accordance with its specifications and operating instructions or the safety of the equipment may be impaired.

Do not exceed the maximum signal levels of the instruments and accessories, as defined in the specifications and operating information, and as shown on the instrument or test fixture panels, or switching card.

When fuses are used in a product, replace with same type and rating for continued protection against fire hazard.

Chassis connections must only be used as shield connections for measuring circuits, NOT as safety earth ground connections.

If you are using a test fixture, keep the lid closed while power is applied to the device under test. Safe operation requires the use of a lid interlock.

If  or  is present, connect it to safety earth ground using the wire recommended in the user documentation.

The  symbol on an instrument indicates that the user should refer to the operating instructions located in the manual.

The  symbol on an instrument shows that it can source or measure 1000 volts or more, including the combined effect of normal and common mode voltages. Use standard safety precautions to avoid personal contact with these voltages.

The **WARNING** heading in a manual explains dangers that might result in personal injury or death. Always read the associated information very carefully before performing the indicated procedure.

The **CAUTION** heading in a manual explains hazards that could damage the instrument. Such damage may invalidate the warranty.

Instrumentation and accessories shall not be connected to humans.

Before performing any maintenance, disconnect the line cord and all test cables.

To maintain protection from electric shock and fire, replacement components in mains circuits, including the power transformer, test leads, and input jacks, must be purchased from Keithley Instruments. Standard fuses, with applicable national safety approvals, may be used if the rating and type are the same. Other components that are not safety related may be purchased from other suppliers as long as they are equivalent to the original component. (Note that selected parts should be purchased only through Keithley Instruments to maintain accuracy and functionality of the product.) If you are unsure about the applicability of a replacement component, call a Keithley Instruments office for information.

To clean an instrument, use a damp cloth or mild, water based cleaner. Clean the exterior of the instrument only. Do not apply cleaner directly to the instrument or allow liquids to enter or spill on the instrument. Products that consist of a circuit board with no case or chassis (e.g., data acquisition board for installation into a computer) should never require cleaning if handled according to instructions. If the board becomes contaminated and operation is affected, the board should be returned to the factory for proper cleaning/servicing.

The information contained in this manual is believed to be accurate and reliable. However, the manufacturer assumes no responsibility for its use; nor for any infringements of patents or other rights of third parties that may result from its use. No license is granted by implication or otherwise under any patent rights of the manufacturer.

THE MANUFACTURER SHALL NOT BE LIABLE FOR ANY SPECIAL, INCIDENTAL, OR CONSEQUENTIAL DAMAGES RELATED TO THE USE OF THIS PRODUCT. THIS PRODUCT IS NOT DESIGNED WITH COMPONENTS OF A LEVEL OF RELIABILITY THAT IS SUITED FOR USE IN LIFE SUPPORT OR CRITICAL APPLICATIONS.

DriverLINX, SSTNET, and LabOBJX are registered trademarks and DriverLINX/VB is a trademark of Scientific Software Tools, Inc.

Microsoft and Windows are registered trademarks and Visual C++ and Visual Basic are trademarks of Microsoft Corporation.

Borland is a registered trademark and Borland C++, Delphi, and Turbo Pascal are trademarks of Borland International, Inc.

IBM is a registered trademark of International Business Machines Corporation.

Acrobat is a registered trademark of Adobe Systems Incorporated.

All other brand and product names are trademarks or registered trademarks of their respective companies.

© Copyright Keithley Instruments, Inc., 1999, 1994.

All rights reserved. Reproduction or adaptation of any part of this documentation beyond that permitted by Section 117 of the 1979 United States Copyright Act without permission of the Copyright owner is unlawful.

**Keithley Instruments, Inc.**  
28775 Aurora Road, Cleveland, OH 44139  
Telephone: (440) 248-0400 • FAX: (440) 248-6168  
<http://www.keithley.com>



# Table of Contents

## Preface

<b>1</b>	<b>Overview</b>	
	Supporting Software .....	1-2
	Accessories .....	1-3
<b>2</b>	<b>Functional Description</b>	
	Analog Output Channels .....	2-3
	Output Ranges .....	2-4
	Clocks .....	2-6
	Pacer Clocks .....	2-6
	Output Clock .....	2-8
	Time Delay .....	2-8
	Pulse Length .....	2-10
	Hardware Trigger .....	2-11
	Hardware Gate .....	2-13
	Interrupts .....	2-15
<b>3</b>	<b>Setup and Installation</b>	
	Unpacking the Board .....	3-1
	Installing the Software .....	3-2
	Installing and Configuring DriverLINX for DDA-08/16 Boards .....	3-2
	Installing the DDA-08/16 Standard Software Package ....	3-4
	Before Installing DriverLINX .....	3-4
	Selecting the DriverLINX Components to Install .....	3-4
	Installing DriverLINX .....	3-5
	Configuration with DriverLINX .....	3-6
	Configuring the Board .....	3-6
	Setting Switches on the Board .....	3-8
	Setting the Base Address .....	3-10
	Setting the Analog Output Range .....	3-12
	Setting the Output Signal .....	3-14
	Setting the Output Range Type .....	3-15
	Setting the Output Span .....	3-17
	Installing the Board .....	3-18
	Configuring DriverLINX .....	3-19

<b>4</b>	<b>Cabling and Wiring</b>	
	Attaching Accessory Boards	4-1
	Attaching an STC-37 Screw Terminal Connector	4-3
	Attaching an STA-U Screw Terminal Accessory	4-4
	Attaching an STP-37 Screw Terminal Panel	4-5
	Connecting Signals	4-6
<b>5</b>	<b>Subsystems and Analog I/O</b>	
	Digital Input Subsystem	5-1
	Digital Input Operations	5-1
	Digital Input Timing Events	5-1
	Counter/Timer Subsystem	5-2
	Analog Output Subsystem	5-2
	Analog I/O Panel	5-3
	Test Panel Application	5-5
<b>6</b>	<b>DriverLINX Calibration and Test Utilities</b>	
	Calibration	6-1
	Equipment Required	6-2
	Potentiometers	6-3
	Converting Voltage to Raw Counts	6-7
	Converting Current to Raw Counts	6-7
<b>7</b>	<b>Troubleshooting</b>	
	Problem Isolation	7-1
	Using the DriverLINX Event Viewer	7-1
	Device initialization error messages	7-2
	Identifying Symptoms and Possible Causes	7-3
	Testing Board and Host Computer	7-5
	Testing Accessory Slot and I/O Connections	7-6
	Technical Support	7-6
<b>A</b>	<b>Specifications</b>	
<b>B</b>	<b>Connector Pin Assignments</b>	

## List of Illustrations

Figure 2-1.	DDA-08/16 Functional Block Diagram . . . . .	2-2
Figure 2-2.	Using a Pacer Clock . . . . .	2-7
Figure 2-3.	Generating an Output Clock Pulse . . . . .	2-10
Figure 2-4.	Using a Hardware Trigger . . . . .	2-12
Figure 2-5.	Using a Hardware Gate . . . . .	2-14
Figure 3-1.	DDA-16 Board . . . . .	3-9
Figure 3-2.	Setting the Base Address . . . . .	3-11
Figure 3-3.	Setting the Output Signal . . . . .	3-15
Figure 3-4.	Setting the Output Range Type . . . . .	3-16
Figure 3-5.	Setting the Output Span . . . . .	3-18
Figure 4-1.	Main I/O Connector on a DDA-16 Board . . . . .	4-2
Figure 4-2.	Attaching an STC-37 Screw Terminal Connector . . . . .	4-3
Figure 4-3.	Attaching an STA-U Screw Terminal Accessory . . . . .	4-4
Figure 4-4.	Attaching an STP-37 Screw Terminal Panel . . . . .	4-5
Figure 4-5.	Voltage Output . . . . .	4-6
Figure 4-6.	Current Output . . . . .	4-7
Figure 6-1.	Potentiometers (DDA-16) . . . . .	6-3
Figure B-1.	Main I/O Connector (DDA-16) . . . . .	B-2

## List of Tables

Table 2-1.	Voltage Output Ranges . . . . .	2-4
Table 3-1.	Configuring DDA-08/16 Boards . . . . .	3-7
Table 3-2.	Base Address Switches . . . . .	3-11
Table 3-3.	Summary of Analog Output Range Switches . . . . .	3-13
Table 3-4.	Output Signal Switches . . . . .	3-14
Table 3-5.	Output Range Type Switches . . . . .	3-16
Table 3-6.	Output Span Switches . . . . .	3-17
Table 6-1.	Potentiometers . . . . .	6-4
Table 7-1.	Troubleshooting Information . . . . .	7-3
Table A-1.	DDA-08/16 Specifications . . . . .	A-1
Table B-1.	Main I/O Connector Pin Assignments for the DDA-16 . . . . .	B-3

# Preface

The *DDA-08/16 User's Guide* provides the information needed to set up, install, and use DDA-08 and DDA-16 boards.

The manual is intended for data acquisition system designers, engineers, technicians, scientists, and other users responsible for setting up, cabling, and wiring signals to DDA-08 and DDA-16 boards. It is assumed that users are familiar with data acquisition principles and with their particular application.

The *DDA-08/16 User's Guide* is organized as follows:

- Section 1 provides an overview of the features of DDA-08 and DDA-16 boards, including a description of supporting software and accessories.
- Section 2 provides a detailed description of the features of DDA-08 and DDA-16 boards.
- Section 3 describes how to unpack, configure, and install DDA-08 and DDA-16 boards.
- Section 4 describes how to attach accessory boards and how to wire signals to DDA-08 and DDA-16 boards.
- Section 5 describes how to use the Control Panel to test the functions of DDA-08 and DDA-16 boards under Windows™.
- Section 6 describes how to calibrate and test the functions of DDA-08 and DDA-16 boards under DOS.
- Section 7 provides troubleshooting information.

- Appendix A lists the specifications for DDA-08 and DDA-16 boards.
- Appendix B lists the connector pin assignments.

An index completes this manual.

Throughout the manual, references to DDA-08/16 boards apply to both DDA-08 and DDA-16 boards. When a feature applies to a particular board, that board's name is used.

# 1

## Overview

DDA-08 and DDA-16 boards are analog output boards. The DDA-08/16 board with DriverLINX software requires:

- An IBM PC or compatible AT (386 or Pentium CPU) with minimum of 16 MB of memory.
- At least one floppy disk drive and one fixed disk drive.
- MS-DOS/PCDOS 3.1 or high.
- Microsoft Windows 3.x, Windows 95/98, or Windows NT 4.0 or higher.
- A compiler supporting Microsoft Windows development.
- A mouse is highly recommended.

The major features of DDA-08/16 boards are as follows:

- Two 4-channel digital-to-analog converters (quad DACs) on the DDA-08 provide eight analog output channels; four quad DACs on the DDA-16 provide 16 analog output channels.
- Multiple analog output channels can be included in an update group and updated simultaneously.
- A switch-selectable output signal (voltage output or current output) is supported for each quad DAC.
- Five unipolar and bipolar, switch-selectable voltage output ranges are supported; a current output range of 4 to 20 mA is supported.
- All onboard switches can be read by software.
- An onboard internal pacer clock is provided; you select the update rate through software.
- An external pacer clock is supported.

- An onboard output clock is provided; you can use the output clock to synchronize other devices to the pacer clock.
- An external digital trigger is supported.
- An external gate is supported.
- An interrupt can be generated when analog output channels are updated.

## Supporting Software

---

The following software is available for operating DDA-08/16 boards:

- **DDA-08/16 standard software package** — Shipped with DDA-08/16 boards. Includes DriverLINX for Microsoft Windows and function libraries for writing application programs under Windows in a high-level language such as Microsoft Visual Basic, Microsoft Visual C++, Delphi, utility programs, and language-specific example programs.
- **DriverLINX** — The high-performance real-time data-acquisition device drivers for Windows application development including:
  - *DriverLINX API DLLs* and drivers supporting the DDA-08/16 hardware.
  - *Analog I/O Panel* — a DriverLINX program that verifies the installation and configuration of DriverLINX to your DDA-08/16 board and demonstrates several virtual bench-top instruments.
  - *Learn DriverLINX* — an interactive learning and demonstration program for DriverLINX that includes a Digital Storage Oscilloscope.
  - *Source Code* — for the sample programs.
  - *DriverLINX Application Programming Interface Files* — for the DDA-08/16 compiler.
  - *DriverLINX On-line Help System* — provides immediate help as you operate DriverLINX.
  - *Supplemental Documentation* — on DriverLINX installation and configuration; analog and digital I/O programming; counter/timer programming; technical reference; and information specific to the DDA-08/16 hardware.

- **DDA-08/16 Utilities** — The following utilities are provided as part of the DDA-08/16 standard software package:
  - Calibrate and Test Utility — allows you to select a device to test and calibrate.
  - DriverLINX Test Panel — allows you to perform a limited number of tests.

---

**Note:** The DDA-08/16 board is calibrated at the factory for *voltage mode*. If the board is to be used in *current mode*, it needs to be recalibrated.

---

## Accessories

---

The following accessories are available for use with DDA-08/16 boards:

- **STC-37 screw terminal connector** — Provides 37 screw terminals that allow you to access the functions of the board; connects directly to the DDA-08/16 board without a cable.
- **STA-U screw terminal accessory** — Provides 37 screw terminals that allow you to access the functions of the board; provides a breadboard area with power and additional screw terminals to access the user-designed circuitry.
- **STP-37 screw terminal panel** — Provides 37 screw terminals that allow you to access the functions of the board; available with a plastic case (STP-37/C) that you can mount in a standard DIN rail.
- **C-1800 cable** — Unshielded, 18-inch cable with a 37-pin connector on each end; allows you to connect a DDA-08/16 board to an STA-U or STP-37. (Note that the C-1800 cable is also available in longer lengths, if required.)
- **S-1800 cable** — Shielded, 18-inch cable with a 37-pin connector on each end; allows you to connect a DDA-08/16 board to an STA-U or STP-37. (Note that the S-1800 cable is also available in longer lengths, if required.)

Refer to Keithley's Products catalog or contact your local sales office for information on obtaining these accessories.



# 2

## Functional Description

This section describes the analog output features of DDA-08/16 boards. A functional block diagram of a DDA-08/16 board is shown in Figure 2-1. Note that quad DAC2 and quad DAC3 are available on DDA-16 boards only.

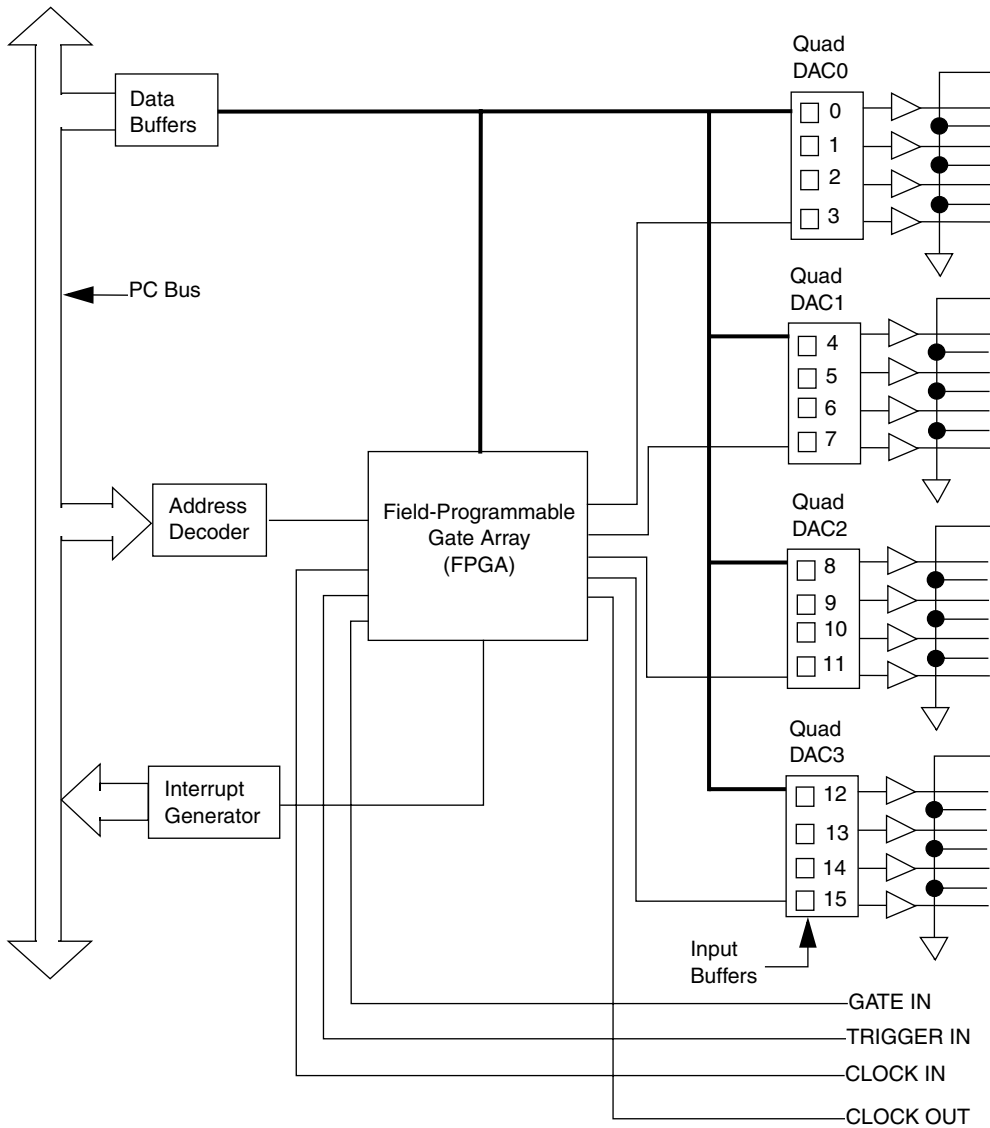

**Figure 2-1. DDA-08/16 Functional Block Diagram**

## Analog Output Channels

---

DDA-08 boards contain two quad DACs (quad DAC0 and quad DAC1), which provide eight analog output channels. DDA-16 boards contain four quad DACs (quad DAC0, quad DAC1, quad DAC2, and quad DAC3), which provide 16 analog output channels. Quad DAC0 contains channels 0 through 3; quad DAC1 contains channels 4 through 7; quad DAC2 contains channels 8 through 11; quad DAC3 contains channels 12 through 15.

Each analog output channel contains an input buffer for storing data. Through software, the host computer loads a single value into the input buffer of a single channel or loads multiple values into the input buffers of a sequence of consecutive channels. The analog output values are held in the input buffers until the channels are updated. At that point, the values currently held in the input buffers are written to the channels, updating their output values.

You can update a single analog output channel immediately when the input buffer is loaded, or you can update several analog output channels simultaneously using a pacer clock. Refer to page 2-6 for more information about pacer clocks.

If you want to update several analog output channels simultaneously, you use software to include one or more quad DACs in the update group. All channels on the quad DACs in the update group are updated simultaneously at each pulse of the pacer clock.

---

**Note:** In multi-channel mode, the DDA-08/16 writes all data to a consecutive range of analog channels.

- If the Start Channel is greater than the Stop Channel, the channel sequence is [Start Channel, ..., Last Channel, 0, ..., Stop Channel], where Last Channel is the highest numbered channel for the DDA-08/16 model the application is using.
- The DDA-08/16 can optionally output to all DACs in the range simultaneously, or write to one DAC in the range at each timing event.

In multi-channel list mode, the DDA-08/16 writes all data to a random list of analog channels.

- The channel-gain list may contain channels in any order but only with unity gain. In simultaneous mode, the list may *not* repeat the same channel.
- The DDA-08/16 can optionally output to all DACs in the list simultaneously, or write to one DAC in the list at each timing event.

Refer to the *Using DriverLINX with Your Hardware, Keithley DDA-08/16* manual that accompanies your DriverLINX software.

---

## Output Ranges

---

DDA-08/16 boards support both voltage output and current output. You select the output signal for each quad DAC using the output signal switches on the board. Refer to page 3-14 for more information.

Voltage output and current output ranges are described as follows:

- **Voltage output** — For voltage output, you can select one of five ranges (0 to 10V, 0 to 5V,  $\pm 10V$ ,  $\pm 5V$ , or  $\pm 2.5V$ ) for each quad DAC. You select the voltage output range using two switches on the board. The output span switch determines the span (5V, 10V, or 20V); the output range type switch determines the output range type (unipolar or bipolar). Refer to page 3-15 and page 3-17 for more information.

Table 2-1 shows the voltage output ranges provided by each span and output range type.

**Table 2-1. Voltage Output Ranges**

Span	Output Range Type	
	Unipolar	Bipolar
5V	0 to 5V	$\pm 2.5V$
10V	0 to 10V	$\pm 5V$
20V	Not applicable <sup>1</sup>	$\pm 10V$

<sup>1</sup> Do not select a 20V span with a unipolar output range type. If you do, the output will saturate at about 10V with approximately a half scale input to the quad DAC.

---

**Notes:** All channels on a quad DAC have the same voltage output range; you cannot select a voltage output range on a channel-by-channel basis.

Make sure that you select a voltage output range that includes all the output values required by the device connected to your board. In addition, make sure that the range does not exceed the required values excessively; this ensures the best possible resolution and prevents potential damage to the device.

---

- **Current output** — For current output, the range is always 4 to 20 mA. For current output, you must set the output range type and the output span switches on the board to current output. Refer to page 3-15 and page 3-17 for more information.

Each analog output channel has a resolution of 12 bits, which translates to a raw count value between 0 and 4095. For bipolar voltage output ranges, a value of 0 represents negative full scale and a value of 4095 represents positive full scale. For unipolar voltage output ranges, a value of 0 represents 0V and a value of 4095 represents positive full scale. For current output ranges, a value of 0 represents 4mA and a value of 4095 represents 20mA.

---

**Note:** To ensure that the analog output channels power-up to a known state, the output value from all channels configured for voltage output is nominally 0V at power-up and the output value from all channels configured for current output is nominally 0mA at power-up.

---

## Clocks

---

DDA-08/16 boards support two types of clocks: a pacer clock and an output clock. These clocks are described in the following sections.

### Pacer Clocks

The pacer clock determines the update rate (the time between each update of all the channels on the quad DACs in the update group). DDA-08/16 boards provide the following software-selectable pacer clocks:

- **Hardware internal pacer clock** — The internal pacer clock uses an onboard time base. The internal pacer clock determines the update rate by multiplying a prescaler value (1 $\mu$ s, 10 $\mu$ s, 100 $\mu$ s, 1ms, 10ms, 100ms, or 1s) by an 8-bit counter value. The prescaler values provide a wide range of update rates; the 8-bit counter value provides the resolution that allows you to achieve the exact update rate you require.

The time between updates can range from 1 $\mu$ s to 4.267 minutes.

For example, assume that you want to update the channels every 50ms. The prescaler value can be 1ms and the counter value can be 50, or the prescaler value can be 10ms and the counter value can be 5.

---

**Notes:** The prescaler value used by the pacer clock is also used to determine the length of the output clock pulse and the time delay between the update of the analog output channels on the quad DACs in the update group and the output clock pulse. Refer to page 2-8 for more information about the output clock.

DriverLINX allows you to specify the Logical Channel (0 = Pacer Clock, 1 = Output Clock), Clock Source, Clock Tic Period, Mode, and Gate. Refer to the *Using DriverLINX with Your Hardware, Keithley DDA-08/16* manual that accompanies your DriverLINX software.

---

When the pacer clock counter is loaded, the channels on the quad DACs in the update group are updated and the pacer clock counter starts counting down. (Note that a slight time delay occurs between

the time the pacer clock counter is loaded and the time the channels are updated.) When the pacer clock counter counts down to zero, all the channels on the quad DACs in the update group are updated again and the process repeats.

- **Hardware external pacer clock** — An external pacer clock is useful if you want to update the channels at rates not available with the internal clock, if you want to update the channels at uneven intervals, or if you want to update the channels based on an external event.

The external pacer clock is an externally applied TTL-compatible signal, which you attach to the CLOCK IN pin (pin 1) of the main I/O connector. At each active edge of the external pacer clock, the channels are updated. The active edge is software-selectable; at power-up, the board assumes that the active edge for an external pacer clock is a falling edge.

Figure 2-2 illustrates how analog output channels are updated when using an internal pacer clock and when using an external pacer clock with a falling edge as the active edge. (Note that Figure 2-2 assumes that you are not using a hardware trigger; refer to Figure 2-4 on page 2-12 when using a hardware trigger.)

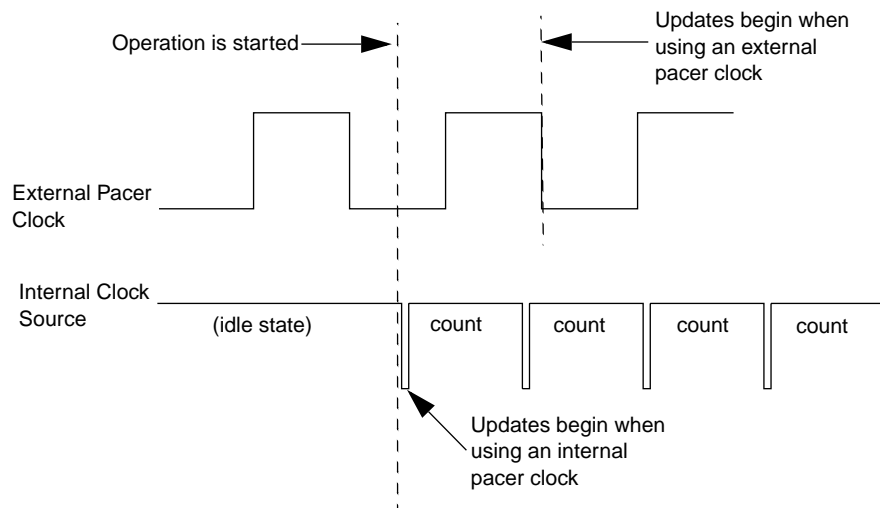

**Figure 2-2. Using a Pacer Clock**

---

**Notes:** When determining the update rate for a hardware pacer clock (internal or external), make sure that you do not update the analog output channels faster than the host computer writes to the input buffers of the channels. Typical update rates range from 1kHz to 20kHz; the actual rate depends on a number of factors, including your computer, the operating system/environment, and software issues. Also keep in mind the settling time of the channels on the DDA-08/16 board; refer to Appendix A for information.

At power-up, the pacer clock is disabled.

---

## Output Clock

If enabled, the output clock generates an output pulse for each update of the analog output channels on the quad DACs in the update group (using either the internal pacer clock or the external pacer clock). You can use this output pulse to synchronize other devices to the pacer clock.

The output pulse is issued from the CLOCK OUT pin (pin 20) of the main I/O connector. The polarity of the output pulse (falling edge or rising edge) is software-selectable. If you select a falling-edge pulse, the output from CLOCK OUT starts high; if you select a rising-edge pulse, the output from CLOCK OUT starts low. On power-up, the board assumes that you want to generate a falling-edge pulse.

## *Time Delay*

Through software, you can specify a time delay between the update of the analog output channels on the quad DACs in the update group and the output clock pulse. The output clock determines the time delay by multiplying the prescaler value used by the internal pacer clock by the output clock's own independent 8-bit counter value. The output clock counter is reloaded each time the analog output channels are updated.

For example, if the prescaler value is 1ms and you want a 30ms time delay between the update of the analog output channels and the output clock pulse, the output clock counter value must be 30.



---

**Notes:** If the output clock counter value is 0, the output clock pulse is generated simultaneously with the update of the analog output channels (no delay).

The DDA-08/16 can write analog output samples **after** the hardware detects a digital trigger condition. Use post-triggering in DriverLINX when you want to synchronize the start of data acquisition with an external signal. Digital Start Events contain *mask*, *pattern*, and *match* fields. The mask is logically ANDed with the digital input data on the Logical Channel and then compared with the *pattern* for a match/mismatch.

- Specify the *Channel* as **0**.
- Specify the *Mask* and *Pattern* properties as **1** to specify the bit position of the 1-bit trigger input.
- Specify the *Match* property as **Not equals** to trigger on the edge of the trigger input.
- Specify the *Delay* property as any number of samples from 0 to  $2^{32} - 1$ .
- Connect the signal to the TRIGGER IN line.

Refer to *Using DriverLINX with Your Hardware, Keithley DDA-08/16* manual that accompanies your DriverLINX software.

---

## Pulse Length

The period of the output pulse is equal to the prescaler value. Since the prescaler generates a square wave, the length of the output pulse is equal to half of the prescaler value. For example, if the prescaler value is 10 ms, the length of the output pulse is 5ms.

Figure 2-3 illustrates a falling-edge output pulse that is 5ms in length (prescaler value is 10ms) and is generated 30ms after the analog output channels on the quad DACs in the update group are updated. Since there is only one prescaler, the prescaler value must be 10ms for both the pacer clock and the output clock.

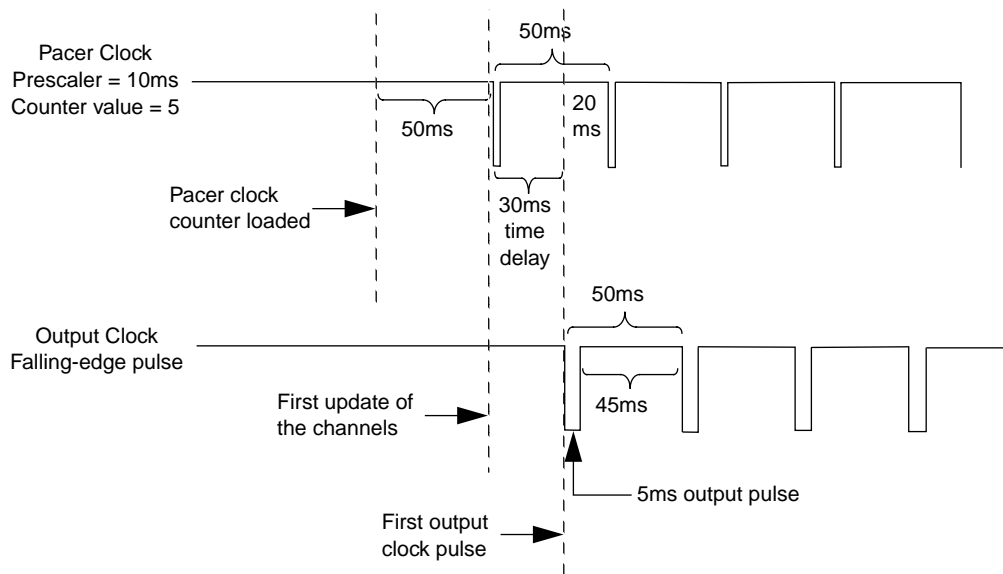

**Figure 2-3. Generating an Output Clock Pulse**

In DriverLINX, Timing Events specify how the hardware paces or clocks the sample output. DriverLINX uses the Timing Event to program when the DDA-08/16 writes the next analog output sample to the DACs.

The DDA-08/16 supports the following Timing Events:

- **None** — Output requires no *spacing* as DriverLINX is writing only a single value.
- **Rate** — The DDA-08/16 supports only fixed rate analog output using internal and external clocks. The Rate Generator provides a fixed rate clock with equal time intervals between tics. An internally clocked Rate Generator produces a fixed rate clock with equal time intervals between tics. An externally clocked Rate Generator produces a rate clock with unknown time intervals between tics.
- **Digital** — DriverLINX uses an external digital input signal to pace the output to each sample.

## Hardware Trigger

You can enable a hardware trigger through software. A hardware trigger is an externally applied, edge-sensitive, digital signal that determines when the analog output channels on the quad DACs in the update group can respond to either an internal or an external pacer clock.

You connect the digital trigger signal to the TRIGGER IN pin (pin 2) of the main I/O connector. If the trigger is enabled, the board waits for an active edge on TRIGGER IN. The active edge is software-selectable; at power-up, the board assumes that the active edge for a hardware trigger is a falling edge.

When the board detects an active edge, the channels respond to each pulse of the pacer clock until the trigger circuitry is disabled.

The actual point at which the channels are updated depends on whether you are using an internal pacer clock or an external pacer clock. These considerations are described as follows:

- **Internal pacer clock** — The internal pacer clock remains idle until the trigger event occurs. When the trigger event occurs, the pacer clock counter is loaded and the channels are updated. (Note that a slight time delay occurs between the time the pacer clock counter is loaded and the time the channels are updated.)

- External pacer clock** — When the trigger event occurs, the board begins monitoring the state of the external pacer clock signal. At the next active edge of the external pacer clock, the channels are updated.

Figure 2-4 illustrates how the channels are updated when using a rising-edge hardware trigger.

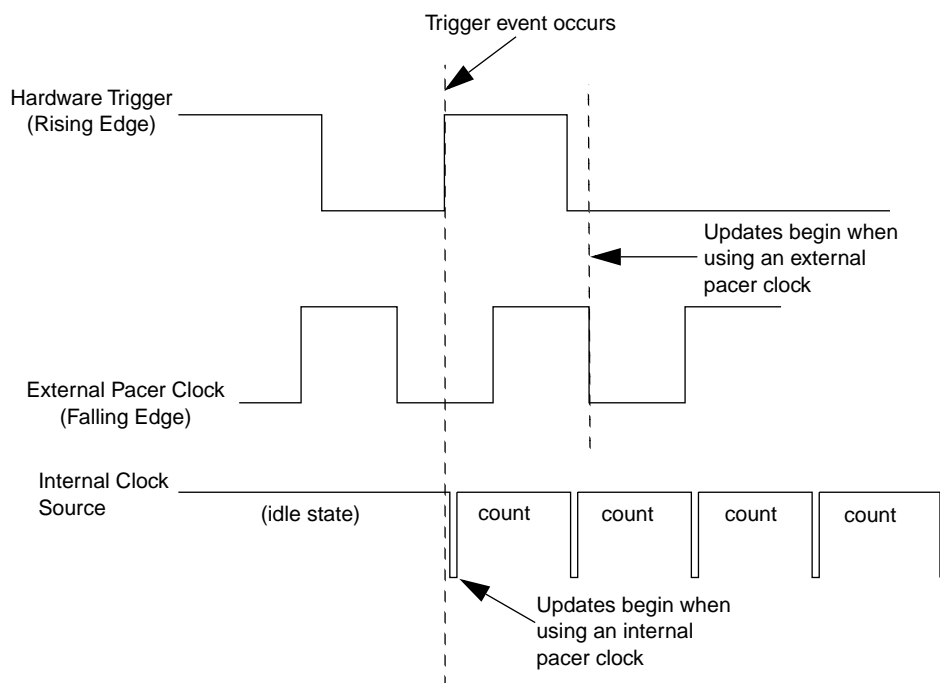

**Figure 2-4. Using a Hardware Trigger**

---

**Note:** The time at which the analog output channels are updated also depends on the pacer clock. Refer to page 2-6 for more information.

---

## Hardware Gate

You can enable a hardware gate through software. A hardware gate is an externally applied, level-sensitive, digital signal that determines when the analog output channels on the quad DACs in the update group are updated.

You connect the gate signal to the GATE IN pin (pin 21) of the main I/O connector. If the hardware gate is enabled, the software-selectable state of the gate signal determines whether the channels are updated, as follows:

- If you specify a positive gate, the channels are updated only if the signal to GATE IN is high; if the signal goes low, the channels are no longer updated.
- If you specify a negative gate, the channels are updated only if the signal to GATE IN is low; if the signal goes high, the channels are no longer updated.

When using the hardware gate, the way the channels are updated depends on whether you are using an internal pacer clock or an external pacer clock. These considerations are described as follows:

- **Internal pacer clock** — The internal pacer clock stops counting down when the gate signal goes inactive. When the gate signal goes active again, the internal pacer clock resumes counting where it left off.
- **External pacer clock** — The signal from the external pacer clock continues uninterrupted while the gate signal is inactive; updates are always synchronized to the external pacer clock.

Figure 2-5 illustrates a positive hardware gate with both an external pacer clock and an internal pacer clock. The polarity of the external pacer clock is falling edge.

---

**Note:** In DriverLINX, use an internally clocked rate generator when you want to write analog output samples at equally spaced time intervals. The DDA-08/16 hardware can write the selected analog output channels simultaneously at each timing event, or individually, with one channel per timing event.

- Specify internal clocking using a **Rate Generator** on **Channel 0** with an **Internal 1 Clock** source.
- The *Period* property specifies the time interval between samples in tics, where a tic is 1 $\mu$ s or 1MHz. The minimum period is 20 tics or 50kHz. The maximum period is 25500 tics or 0.004Hz.
- The *Gate* property specifies how the GATE IN signal affects sampling.

Refer to *Using DriverLINX with Your Hardware, Keithley DDA-08/16* manual that accompanies your DriverLINX software.

---

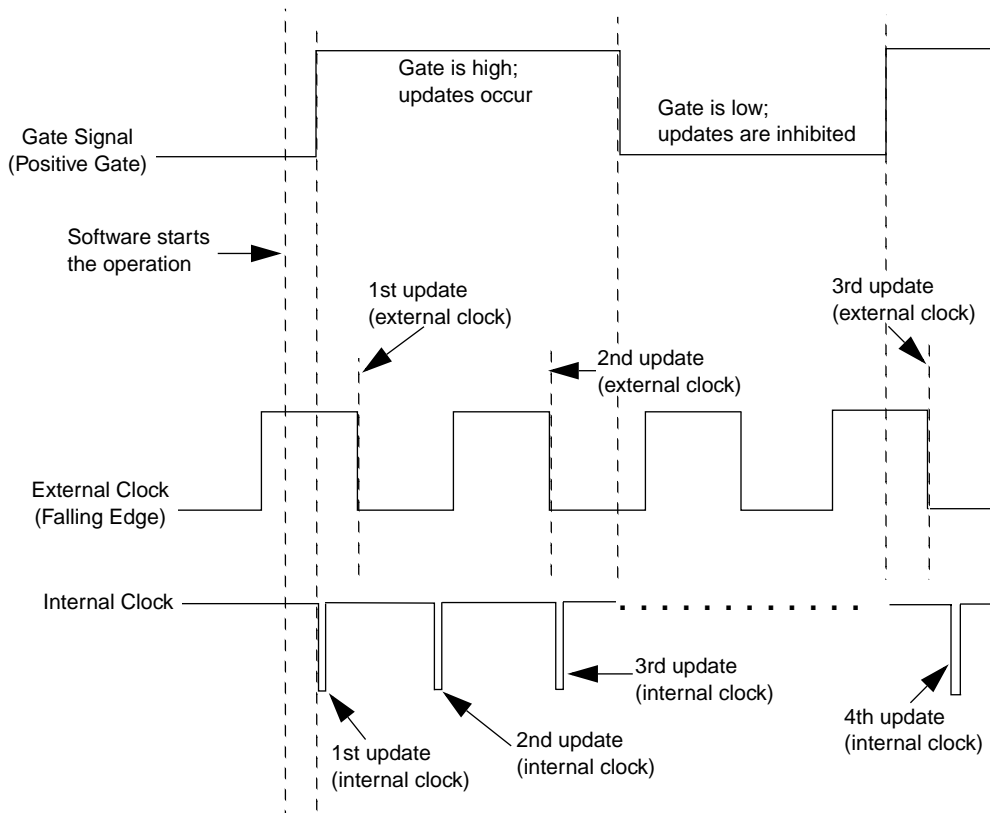

**Figure 2-5. Using a Hardware Gate**

## Interrupts

You can enable DDA-08/16 boards to automatically generate an interrupt each time the analog output channels on the quad DACs in the update group are updated. To enable interrupts, you specify an interrupt level (3, 5, 7, 10, 11, or 15) through software. On power-up, interrupts are disabled.

DDA-08/16 boards use pulsed interrupts; this allows a DDA-08/16 board to share an interrupt level with another DDA-08/16 board.

When an interrupt line is not being used to generate an interrupt, the interrupt line remains in its normal state (tristated). When a board requests an interrupt, the board momentarily pulses the interrupt line and then sets a flag on the board. The software can cycle through the boards to determine which boards need their interrupts serviced.

---

**Note:** Sharing an interrupt level with a device other than another DDA-08/16 board may cause a bus conflict.

---

# 3

## Setup and Installation

Read this section and all related DriverLINX documentation before you attempt to install and use your DDA-08/16 board.

### Unpacking the Board

---

---

**Caution:** A discharge of static electricity from your hands can seriously damage certain electrical components on any circuit board. It is recommended that you use wrist strap grounds when handling a board. If wrist strap grounds are not available, discharge static electricity from yourself by touching a grounded conductor such as your computer chassis (your computer must be turned OFF). When handling a board, always hold it by the edges and avoid touching any board components.

---

To prevent damage to your DDA-08/16 board, perform the following steps when unpacking the board:

1. Remove the wrapped DDA-08/16 board from its outer shipping carton.
2. Carefully remove the board from its anti-static wrapping material. (Store the wrapping material for future use.)
3. Inspect the board for signs of damage. If any damage is apparent, arrange to return the board to the factory; refer to Section 7 for more information.



4. Check the remaining contents of your package against the packing list to ensure that your order is complete. Report any missing items immediately.
5. Once you have determined that the board is acceptable, you can install the software and configure the board. Refer to the following sections for information.

## Installing the Software

---

### Installing and Configuring DriverLINX for DDA-08/16 Boards

---

**Important:** As a precaution against a system crash the first time you install and test any new hardware, exit all other programs and, if using a disk cache, disable write caching. If the system does crash and you are using disk compression software or a disk cache utility, as a precaution after any crash, run the utility that checks the directory structures.

---

This section describes how to install the DDA-08/16 standard software package. The contents of these software packages are described as follows:

- **DDA-08/16 standard software package** — Shipped with DDA-08/16 boards. Includes DriverLINX for Microsoft Windows and function libraries for writing application programs under Windows in a high-level language such as Microsoft Visual Basic, Microsoft Visual C++, Delphi, utility programs, and language-specific example programs.
- **DriverLINX** — The high-performance real-time data-acquisition device drivers for Windows application development includes:
  - *DriverLINX API DLLs* and drivers supporting the DDA-08/16 hardware.
  - *Analog I/O Panel* — a DriverLINX program that verifies the installation and configuration of DriverLINX to your DDA-08/16 board and demonstrates several virtual bench-top instruments.

- *Learn DriverLINX* — an interactive learning and demonstration program for DriverLINX that includes a Digital Storage Oscilloscope.
- *Source Code* — for the sample programs.
- *DriverLINX Application Programming Interface Files* — for the DDA-08/16 compiler.
- *DriverLINX On-line Help System* — provides immediate help as you operate DriverLINX.
- *Supplemental Documentation* — on DriverLINX installation and configuration; analog and digital I/O programming; counter/timer programming; technical reference; and information specific to the DDA-08/16 hardware.
- **DDA-08/16 Utilities** — The following utilities are provided as part of the DDA-08/16 standard software package:
  - *Calibrate and Test Utility* — allows you to select a device to test or calibrate.
  - *DriverLINX Test Panel* — allows you to perform a limited number of tests.

---

**Note:** The DDA-08/16 board is calibrated at the factory for *voltage mode*. If the board is to be used in *current mode*, it needs to be recalibrated. To ensure the accuracy of your board, make sure that you calibrate all analog output channels.

---

## Installing the DDA-08/16 Standard Software Package

---

**Important:** Before you begin installing any hardware or software for the DDA-08/16, read the *DriverLINX Installation and Configuration Guide* and *Using DriverLINX with your Hardware, Keithley DDA-08/16* manuals that are packaged with the DriverLINX software. They are accessed from the DriverLINX CD-ROM after you have installed Adobe Acrobat.

---

### ***Before Installing DriverLINX***

1. Inventory your DDA-08/16 board's configuration settings.
2. Determine the resources your DDA-08/16 board requires.
3. Inventory your computer's resources already allocated to other installed devices.
4. Determine whether your computer has sufficient resources for your DDA-08/16 board.
5. Determine whether your DDA-08/16 board can use your computer's free resources.
6. Set any jumpers/switches to configure your DDA-08/16 board to use your computer's free resources.
7. Set any other jumpers/switches to configure your DDA-08/16 board to your preference.
8. Install your DDA-08/16 board into an appropriate free slot in your computer.

### ***Selecting the DriverLINX Components to Install***

For your convenience in installing and uninstalling just the DriverLINX components you need, the DriverLINX CD Browser will assist you in selecting the components to install:

- **Install Drivers** — This required component installs only the files you need for configuring your hardware and running third-party data-acquisition applications that require DriverLINX.

- **Install Interfaces** — This optional component installs the files and example programs that you will need to develop custom applications for DriverLINX using C/C++, Visual Basic, Delphi, and LabVIEW.
- **Install Documentation** — This optional component installs electronic documentation for DriverLINX that you can read, search, and print using Adobe Acrobat Reader.
- **Install Acrobat** — This optional component installs Adobe Acrobat Reader for the DriverLINX electronic documentation.

## Installing DriverLINX

1. Insert the DriverLINX CD-ROM into your computer's CD-ROM Drive.
2. Start the DriverLINX setup program. On most systems, wait a few seconds for automatic startup. Otherwise, run the setup.exe program from the CD-ROM.
3. The DriverLINX CD-ROM Browser Map window appears on the screen. Click Install Drivers, and follow the series of on-screen instructions.

---

**Note:** To display an explanation of a menu option on the DriverLINX CD browser map that appears next and on subsequent setup screens, place the mouse pointer over the menu item. A star next to a menu item means that the item was selected previously.

---

4. Select Read Me First, and follow the instructions.
5. Select Install Documentation. If you do not have Adobe Acrobat installed on your computer, install it by selecting Install Adobe Acrobat.
6. Open the manuals appropriate to the DDA-08/16 installation and read them before installing your DDA-08/16 board or configuring DriverLINX:
  - *Installation and Configuration*
  - *Using DriverLINX with Your Hardware, Keithley DDA-08/16*
  - *DriverLINX Technical Reference Manual*
  - *DriverLINX Analog I/O Programming Guide*

- *DriverLINX Digital I/O Programming Guide*
- *DriverLINX Counter/Timer Programming Guide*
- *Appendix, I/O Port, Interrupt, and DMA Channel Usage*
- Other manuals appropriate to your installation.

## Configuration with DriverLINX

Follow the DriverLINX on-screen instructions for installation of drivers and interfaces. Refer to *DriverLINX Installation and Configuration Guide* and *Using DriverLINX with Your Hardware, Keithley DDA-08/16* manuals.

---

**Note:** Be sure to note and follow all programming differences between installations for Windows NT and Windows 95/98.

---

Before you configure DriverLINX for operation with the DDA-08/16 board, you must specify the base address, interrupt level, and analog output range for each quad DAC configuration by setting switches on the board.

## Configuring the Board

---

You can configure the following items for DDA-08/16 boards:

- Board number
- Board type
- Base address
- Interrupt level
- Analog output range for each quad DAC

You must specify the base address and the analog output range for each quad DAC by setting switches on the board. Refer to page 3-10 for information on setting the base address; refer to page 3-12 for information on setting the analog output range.

To use your DDA-08/16 with DriverLINX or any application program that requires a configuration file, you must indicate the board number, board type, base address, interrupt level, and analog output range in a configuration file.

Table 3-1 lists the items that are configurable for DDA-08/16 boards, the available options, and the default settings in the configuration file. Be sure to make note of the configuration of all switches and jumpers on the board. You will use this information to enter the correct configuration parameters using DriverLINX. Also locate any information or notes about the interrupt and DMA channels used by the other hardware devices in your computer system.

**Table 3-1. Configuring DDA-08/16 Boards**

Attribute	Options	Where Options are Set		Default in DriverLINX Configuration File
		DriverLINX Configuration File	Switches on Board	
Board number	0, 1, 2, 3	✓		0
Board type	DDA-08, DDA-16	✓		DDA-16
Base address <sup>1</sup>	First of 8 consecutive 8-bit locations	✓	✓	300h <sup>2</sup>
Interrupt level <sup>3</sup>	3, 5, 7, 10, 11, 15	✓		10
Analog output range <sup>4</sup>	0 to 10V, 0 to 5V ±10V, ±5V, ±2.5V 4 to 20mA	✓	✓	0 to 10V

<sup>1</sup> Required by DriverLINX and other software packages to perform DDA-08/16 board operations.

<sup>2</sup> The default base address for board 0 is 300h. If you are using multiple DDA-08/16 boards, the default base address for board 1 is 308h, the default base address for board 2 is 310h, and the default base address for board 3 is 318h.

<sup>3</sup> On power-up, interrupts are disabled. If you are not using interrupts, this setting is ignored.

<sup>4</sup> Configured for each quad DAC. The setting in DriverLINX must match the settings of switches on the board. On power-up, the output value from all analog output channels is nominally 0V or 0mA.

## Setting Switches on the Board

Figure 3-1 illustrates the location of the switches on a DDA-16 board. Note that the switches on a DDA-08 board are the same as the switches on the DDA-16 except that the DDA-08 board does not contain the output signal switches for quad DAC2 and quad DAC3, the output range type switches for quad DAC2 and quad DAC3, or the output span switches for quad DAC2 and quad DAC3.

Refer to the following subsections for information on setting these switches.

---

**Note:** If switches on the board are changed after the software has been installed, the software will need to be reconfigured.

---

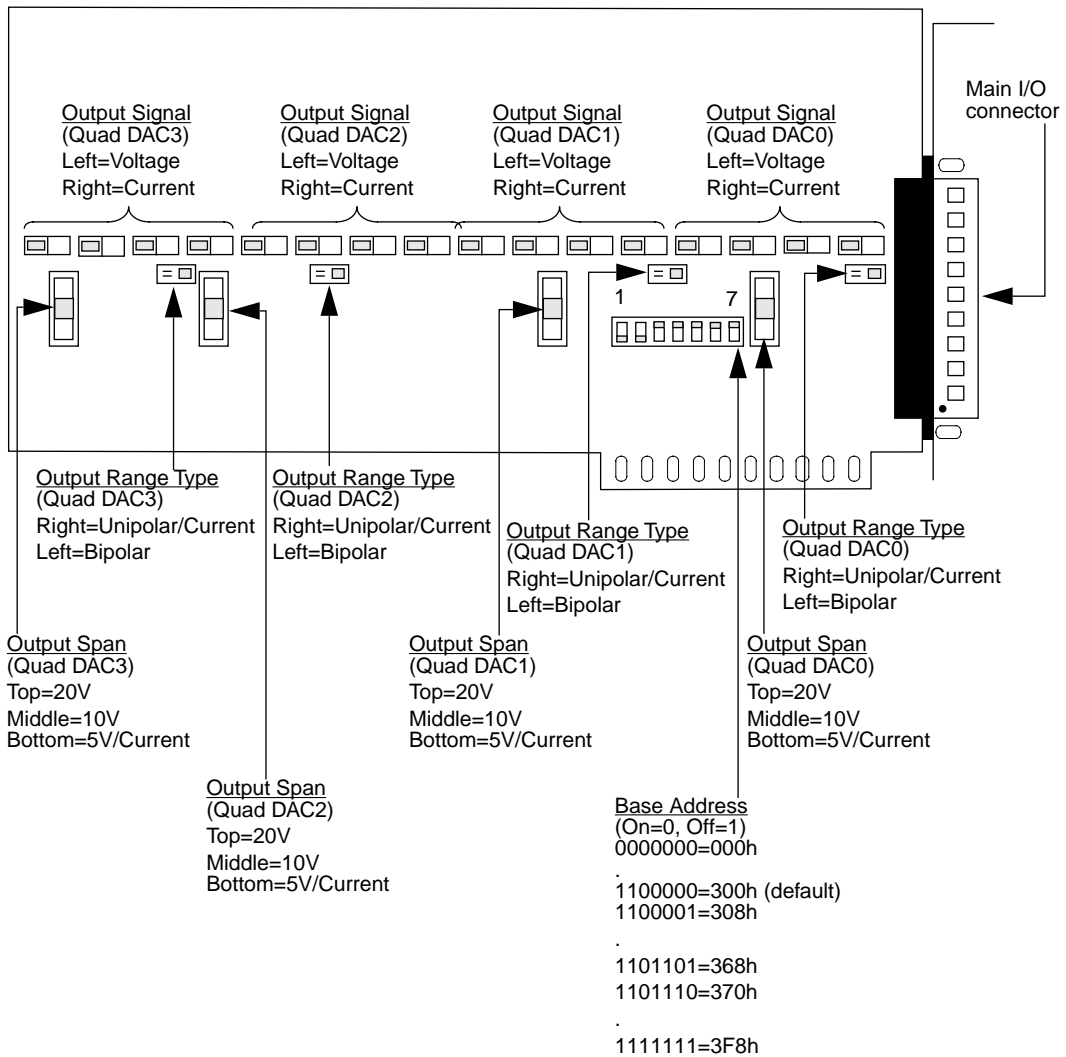

**Figure 3-1. DDA-16 Board**



## ***Setting the Base Address***

DDA-08/16 boards require eight consecutive 8-bit locations in the I/O space of your host computer. DDA-08/16 boards are shipped with a base address of 300h. If any of the address locations between 300h and 307h are being used by another resource in your system (including another DDA-08/16 board), you must reconfigure the base address using the base address switch block (labeled S9 on the board).

---

**Note:** The default base address setting in the DriverLINX configuration file is 0x300hex (768 decimal) for board 0, 308h for board 1, 310h for board 2, and 318h for board 3 (a block of eight free addresses for each DDA-08/16 board). Make sure that the switch settings for each board match the DriverLINX settings for each board.

---

The base address switch block contains seven switches, labeled 1 through 7. The location of the base address switch block on the DDA-08/16 board is shown in Figure 3-1.

Place a switch in the ON position (logic 0) by sliding the switch toward the top (numbered side) of the switch block. Place a switch in the OFF position (logic 1) by sliding the switch toward the bottom (unnumbered side) of the switch block.

A switch in the ON position corresponds to a value of 0; a switch in the OFF position corresponds to the value shown in Table 3-2.

**Table 3-2. Base Address Switches**

Switch	Value When Switch is OFF	
	Hexadecimal	Decimal
1	200	512
2	100	256
3	80	128
4	40	64
5	20	32
6	10	16
7	8	8

Figure 3-2 illustrates the setting for a base address of 300h (768 decimal). Switches 1 and 2 are in the OFF position ( $200h + 100h = 300h$ ;  $512 + 256 = 768$ ); all the other switches (3, 4, 5, 6, and 7) are in the ON position.

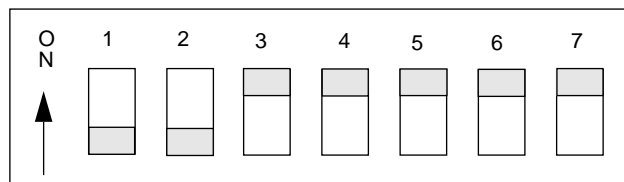

**Figure 3-2. Setting the Base Address**

Determine an even boundary of eight I/O addresses that is not being used by another resource in your system (including another DDA-08/16 board), and set the switches to the appropriate base address. It is recommended that you use a base address between 300h and 370h, if possible.

---

**Notes:** Typically, base addresses between 300h and 370h are available for use. However, keep in mind that a network board, a sound board, a CD-ROM, or other data acquisition board may use a base address within this space.

DriverLINX allows you to set base addresses between 200h and 3F0h only. Therefore, if you are using your DDA-08/16 board with software that requires a configuration file, you must specify an even boundary of eight I/O addresses within the range of 200h to 3F8h.

---

### ***Setting the Analog Output Range***

Specify the analog output range by setting the following switches for each quad DAC:

- The output signal switches (four for each quad DAC) allow you to select voltage output or current output.
- The output range type switch allows you to select bipolar voltage output, unipolar voltage output, or current output.
- The output span switch allows you to select a 5V span, a 10V span, a 20V span, or current output.

Table 3-3 summarizes the settings of the switches on a DDA-08/16 board that determine the analog output range for each quad DAC.

**Table 3-3. Summary of Analog Output Range Switches**

Quad DAC	Range	Switches		
		Output Signal	Output Range Type	Output Span
Quad DAC0	0 to 10V	S10 to S13 = Voltage	S1 = Unipolar/Current	S5 = 10V
	0 to 5V	S10 to S13 = Voltage	S1 = Unipolar/Current	S5 = 5V/Current
	±10V	S10 to S13 = Voltage	S1 = Bipolar	S5 = 20V
	±5V	S10 to S13 = Voltage	S1 = Bipolar	S5 = 10V
	±2.5V	S10 to S13 = Voltage	S1 = Bipolar	S5 = 5V/Current
	4 to 20mA	S10 to S13 = Current	S1 = Unipolar/Current	S5 = 5V/Current
Quad DAC1	0 to 10V	S14 to S17 = Voltage	S2 = Unipolar/Current	S6 = 10V
	0 to 5V	S14 to S17 = Voltage	S2 = Unipolar/Current	S6 = 5V/Current
	±10V	S14 to S17 = Voltage	S2 = Bipolar	S6 = 20V
	±5V	S14 to S17 = Voltage	S2 = Bipolar	S6 = 10V
	±2.5V	S14 to S17 = Voltage	S2 = Bipolar	S6 = 5V/Current
	4 to 20mA	S14 to S17 = Current	S2 = Unipolar/Current	S6 = 5V/Current
Quad DAC2	0 to 10V	S18 to S21 = Voltage	S3 = Unipolar/Current	S7 = 10V
	0 to 5V	S18 to S21 = Voltage	S3 = Unipolar/Current	S7 = 5V/Current
	±10V	S18 to S21 = Voltage	S3 = Bipolar	S7 = 20V
	±5V	S18 to S21 = Voltage	S3 = Bipolar	S7 = 10V
	±2.5V	S18 to S21 = Voltage	S3 = Bipolar	S7 = 5V/Current
	4 to 20mA	S18 to S21 = Current	S3 = Unipolar/Current	S7 = 5V/Current
Quad DAC3	0 to 10V	S22 to S25 = Voltage	S4 = Unipolar/Current	S8 = 10V
	0 to 5V	S22 to S25 = Voltage	S4 = Unipolar/Current	S8 = 5V/Current
	±10V	S22 to S25 = Voltage	S4 = Bipolar	S8 = 20V
	±5V	S22 to S25 = Voltage	S4 = Bipolar	S8 = 10V
	±2.5V	S22 to S25 = Voltage	S4 = Bipolar	S8 = 5V/Current
	4 to 20mA	S22 to S25 = Current	S4 = Unipolar/Current	S8 = 5V/Current

The following sections describe how to set these switches.

---

**Note:** Ensure that the analog output range for a quad DAC, which you set using switch settings is the same as the output range that you configure using DriverLINX.

---

### Setting the Output Signal

DDA-08/16 boards are shipped with the output signal for all quad DACs set to voltage output. If this is not appropriate for your application, you can reconfigure the output signal for a quad DAC using four 2-position output signal switches.

---

**Note:** For a particular quad DAC, all four output signal switches must be set to the same output signal.

---

The output signal switches are labeled as shown in Table 3-4. Note that the DDA-08 board does not contain the output signal switches for quad DAC2 and quad DAC3.

**Table 3-4. Output Signal Switches**

Quad DAC	Labels
Quad DAC0	S10 to S13
Quad DAC1	S14 to S17
Quad DAC2	S18 to S21
Quad DAC3	S22 to S25

---

**Note:** The DDA-08/16 board is calibrated at the factory for *voltage mode*. If the board is to be used in *current mode*, it needs to be recalibrated.

---

---

**Note:** The DriverLINX default analog output range for each quad DAC in the DriverLINX configuration file is 0 to 10V (indicating voltage output). Make sure you note the switch settings on the board so that you can program the DriverLINX configuration to match.

---

The locations of the output signal switches on a DDA-08/16 board are shown in Figure 3-1.

Find the four switches for the appropriate quad DAC. Slide the switch to the left for voltage output; slide the switch to the right for current output. Figure 3-3 illustrates the settings for voltage output.

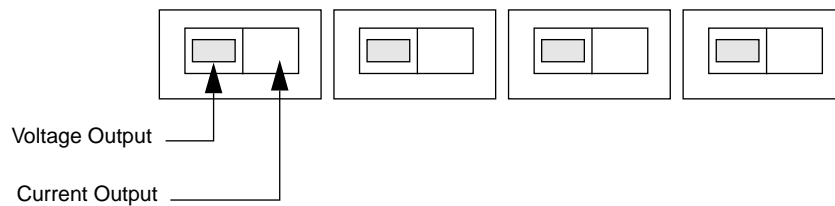

**Figure 3-3. Setting the Output Signal**

### Setting the Output Range Type

DDA-08/16 boards are shipped with the output range type for all quad DACs set to unipolar/current. If this is not appropriate for your application, you can reconfigure the output range type for a quad DAC using the 2-position output range type switch.

The output range type switches are labeled as shown in Table 3-5. Note that the DDA-08 board does not contain the output range type switches for quad DAC2 and quad DAC3.

**Table 3-5. Output Range Type Switches**

Quad DAC	Label
Quad DAC0	S1
Quad DAC1	S2
Quad DAC2	S3
Quad DAC3	S4

---

**Note:** The default analog output range in the DriverLINX default configuration for each quad DAC is 0 to 10V (indicating unipolar voltage output). Make sure you note the switch settings on the board so that you can program the DriverLINX configuration to match.

---

The locations of the output range type switches on a DDA-08/16 board are shown in Figure 3-1.

Find the switch for the appropriate quad DAC. Slide the switch to the left for bipolar voltage output; slide the switch to the right for unipolar voltage output or current output.

Figure 3-4 illustrates the setting for unipolar voltage output or current output.

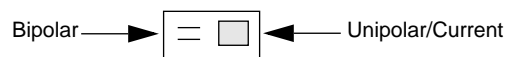

**Figure 3-4. Setting the Output Range Type**

## Setting the Output Span

DDA-08/16 boards are shipped with the output span for all quad DACs set to 10V. If this is not appropriate for your application, you can reconfigure the output span for each quad DAC using the 3-position output span switch.

The output span switches are labeled as shown in Table 3-6. Note that the DDA-08 board does not contain the output span switches for quad DAC2 and quad DAC3.

**Table 3-6. Output Span Switches**

Quad DAC	Label
Quad DAC0	S5
Quad DAC1	S6
Quad DAC2	S7
Quad DAC3	S8

---

**Note:** The default analog output range for each quad DAC in the DriverLINX default configuration is 0 to 10V (indicating a 10V span). Make sure you note the switch settings on the board so that you can program the DriverLINX configuration to match.

---

The locations of the output span switches on the DDA-08/16 boards are shown in Figure 3-1.

Find the switch for the appropriate quad DAC. Slide the switch to the top position for a 20V span; slide the switch to the middle position for a 10V span; slide the switch to the bottom position for a 5V span or for current output.



Figure illustrates the setting for a 10V span.

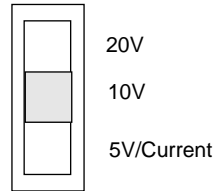

**Figure 3-5. Setting the Output Span**

## Installing the Board

---

Before installing a DDA-08/16 board in your computer, make sure that the switches are set appropriately. Make sure to note the switch settings so that you can match these settings when you program the configuration using DriverLINX. Refer to the *DriverLINX Installation and Configuration Guide* and *Using DriverLINX with Your Hardware, Keithley DDA-08/16* manuals.

Refer to the documentation provided with your computer for more information on installing boards.

---

**Caution:** Make sure that power is turned OFF. Installing or removing a board with the power ON can damage your computer.

---

To install the board, perform the following steps:

1. Turn power to the computer and all attached equipment OFF.
2. Remove the computer chassis cover.
3. Select an available slot. DDA-08/16 boards require a full-size slot.
4. Loosen and remove the screw at the top of the blank adapter plate, and then slide the plate up and out to remove.
5. Insert and secure the board connector in the selected slot.
6. Replace the computer chassis cover.

## Configuring DriverLINX

---

After you have successfully installed the DDA-08/16 board in your computer, start Windows to install DriverLINX. For detailed instructions on installing DriverLINX, see the documentation provided on the DriverLINX CD-ROM; especially refer to *DriverLINX Installation and Configuration Guide* and *Using DriverLINX with Your Hardware, Keithley DDA-08/16* manuals.

---

**Note:** Be sure to note and follow differences in programming between Windows NT and Windows 95/98 as appropriate for your system.

---

Run “Learn DriverLINX” (**LearnDL.exe**) from the DriverLINX program group to tell DriverLINX how you configured your DDA-08/16 board and to verify that everything is properly installed and configured.

1. Start Windows as you normally would and select the Program Manager window. Install DriverLINX if you have not previously done so.
2. Either select the “Learn DriverLINX” icon created when you installed DriverLINX or enter “<drive?:/DRVLNX/LEARNDL” in the *Command Line* edit box. Activate the command line edit box by selecting the *Run...* option from the *File* menu. <drive> is the letter of the hard disk drive where DriverLINX is installed.
3. Immediately after loading Learn DL, the Open DriverLINX DLL dialog box appears. Select the name of the hardware-specific DLL from the list for your DDA-08/16 board. The name is an abbreviation of the board’s model number.
4. From the main menu bar of **Learn DL**, select the *Device* menu and choose *Select...*
5. Select the Logical Device you wish to configure and then click on the *OK* button (return).
6. Again select the *Device* menu and then choose the *Configure...* option to display the Device Configuration Dialog Box.
7. From the *Model* list, select the model name for the DDA-08/16 board you are configuring.

8. If the value displayed in the *Address* edit box is not correct, type the correct value into the box. You may enter the address in decimal or hexadecimal using the c-notation for hex, (that is, 768 decimal = 0x300 hexadecimal).
9. Choose the correct options for the *Analog*, *Digital*, and *Counter/Timer Sections* by first clicking on the appropriate radio button in the middle of the dialog box and then completing the group of dialog fields in the lower third of the dialog box. Be sure to click on both the *Input* and *Output* radio buttons for the *Analog* and *Digital* groups to see all the dialog fields.
10. After you have made your selections, save the configuration parameters by clicking on the *OK* button. This will create or update the configuration file, KMBDDA16.INI in the Windows directory.
11. Repeat the preceding steps starting at step 5 for each Logical Device you wish to configure.

You can use DriverLINX to verify board operation:

1. To physically initialize the DDA-08/16, select *Device/Initialize* from the main menu in Learn DriverLINX.
2. The first time the DDA-08/16 is initialized, or after a configuration change, DriverLINX runs a diagnostic program to verify the operation and accuracy of the configuration settings.

After you install the DDA-08/16 board and configure DriverLINX for the desired DDA-08/16 configuration, you can attach an accessory board and wire the appropriate signals to the board; refer to Section 4 for information. Before writing your application program, you can test the functions of the DDA-08/16 board using the DriverLINX Calibration Test Panel. Refer to Section 5, Section 6, and the *DriverLINX Installation and Configuration Guide* and *Using DriverLINX with Your Hardware*, Keithley DDA-08/16 manuals.

# 4

## Cabling and Wiring

This section describes how to attach accessory boards to a DDA-08/16 board and provides valuable information for connecting signals from a DDA-08/16 board.

---

**Caution:** Before you make any connections to a DDA-08/16 board, make sure that power to your computer and any accessories attached to the DDA-08/16 board are OFF.

---

### Attaching Accessory Boards

---

You can use the following accessory boards to connect signals from the DDA-08/16 board to your application:

- STC-37 screw terminal connector
- STA-U screw terminal accessory
- STP-37 screw terminal panel

You attach an STC-37, an STA-U, or an STP-37 to a DDA-08/16 board through the main I/O connector, a 37-pin, D-type connector that is labeled J5 on the board. The main I/O connector and its pin assignments on a DDA-16 board are shown in Figure 4-1. (The pin assignments on a DDA-08 board are the same as the pin assignments on a DDA-16 except that pins 12 through 19 and pins 30 through 37 are not used.) Refer to Appendix B for a more detailed description of the pins.

Top of Board (Rear View)

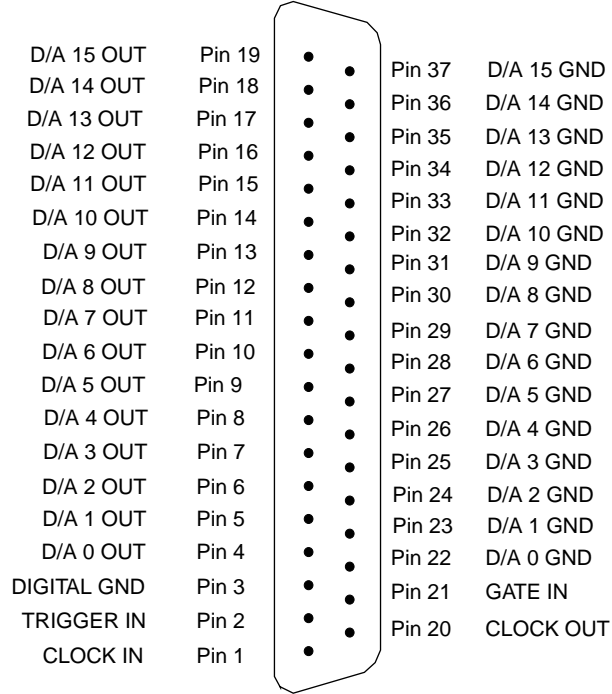

**Figure 4-1. Main I/O Connector on a DDA-16 Board**

## Attaching an STC-37 Screw Terminal Connector

The screw terminals on the STC-37 screw terminal connector allow you to connect field wiring to a DDA-08/16 board. The screw terminals are labeled from 1 to 37 and correspond directly to the functions of the pins on the main I/O connector on the board. For example, since pin 1 is assigned to the external pacer clock, use screw terminal 1 to attach an external pacer clock. Refer to Appendix B for a complete list of pin assignments.

To attach an STC-37 to a DDA-08/16 board, directly connect the 37-pin connector on the STC-37 to the main I/O connector on the DDA-08/16 board. Figure 4-2 illustrates the connection of an STC-37 to a DDA-08/16 board.

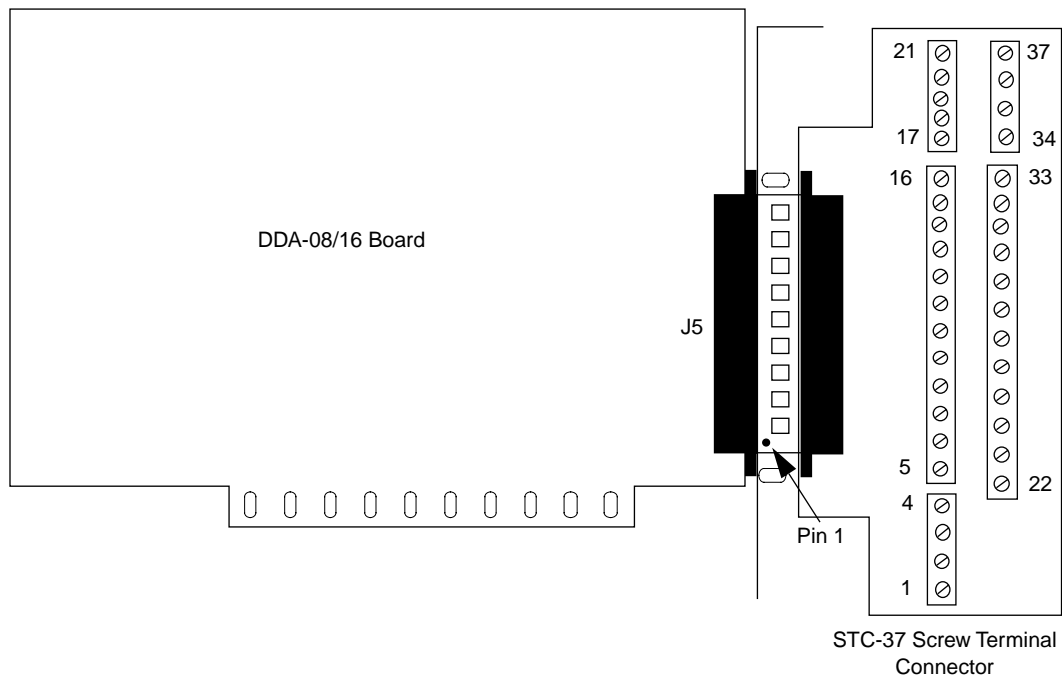

Figure 4-2. Attaching an STC-37 Screw Terminal Connector

## Attaching an STA-U Screw Terminal Accessory

The screw terminals on the STA-U screw terminal accessory allow you to connect field wiring to a DDA-08/16 board. The screw terminals are labeled from 1 to 37 and correspond directly to the functions of the pins on the main I/O connector on the board. For example, since pin 2 is assigned to the external trigger, use screw terminal 2 to attach an external trigger. Refer to Appendix B for a complete list of pin assignments.

To attach an STA-U to a DDA-08/16 board, connect one end of an S-1800 or C-1800 cable to the main I/O connector on the DDA-08/16 board and the other end of the cable to either the J2 or J3 connector on the STA-U. (The C-1800 is the unshielded version of the cable; the S-1800 is the shielded version of the cable.)

Figure 4-3 illustrates the connection of an STA-U to a DDA-08/16 board.

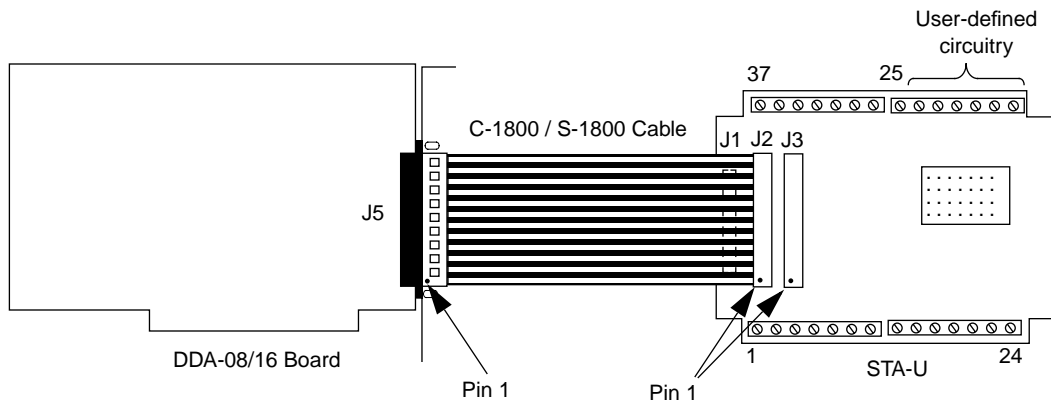

**Figure 4-3. Attaching an STA-U Screw Terminal Accessory**

## Attaching an STP-37 Screw Terminal Panel

The screw terminals on the STP-37 screw terminal panel allow you to connect field wiring to a DDA-08/16 board. The screw terminals are labeled from 1 to 37 and correspond directly to the functions of the pins on the main I/O connector on the board. For example, since pin 21 is assigned to the hardware gate, use screw terminal 21 to attach a hardware gate. Refer to Appendix B for a complete list of pin assignments.

To attach an STP-37 to a DDA-08/16 board, connect one end of an S-1800 or C-1800 cable to the main I/O connector on the DDA-08/16 board and the other end of the cable to the J1 connector on the STP-37. (The C-1800 is the unshielded version of the cable; the S-1800 is the shielded version of the cable.)

Figure 4-4 illustrates the connection of an STP-37 to a DDA-08/16 board.

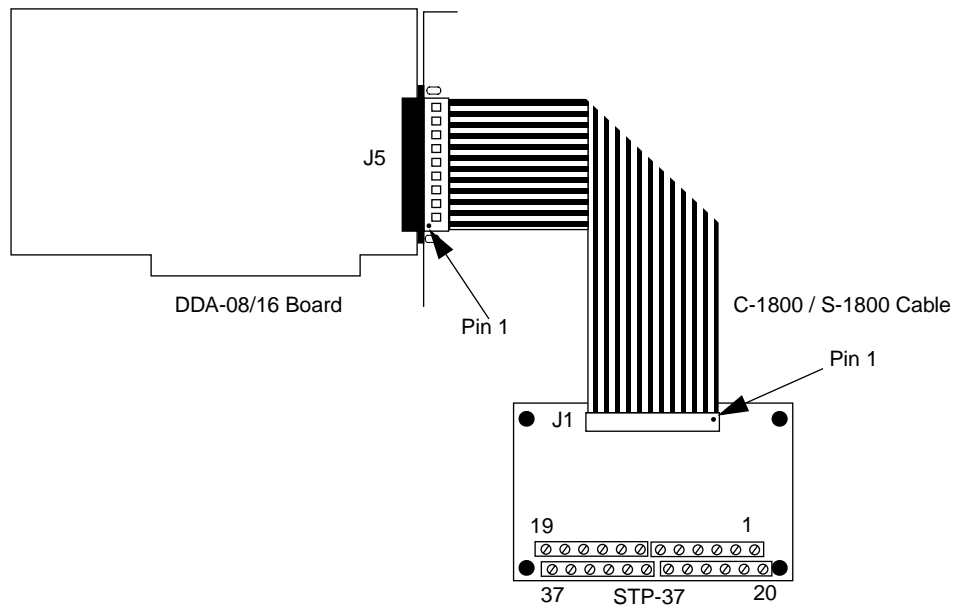

Figure 4-4. Attaching an STP-37 Screw Terminal Panel



## Connecting Signals

---

This section contains information you need when wiring signals from a DDA-08/16 board to your application.

Figure 4-5 illustrates how to connect a voltage output signal from a DDA-08/16 board to your application. Figure 4-6 illustrates how to connect a current output signal from a DDA-08/16 board to your application.

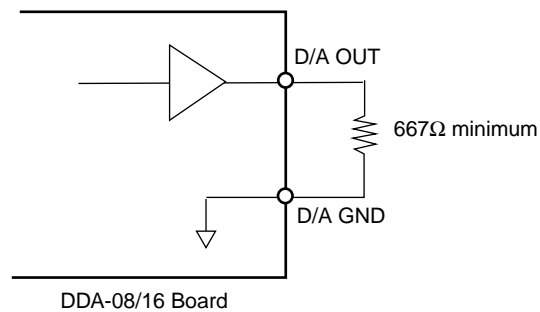

**Figure 4-5. Voltage Output**

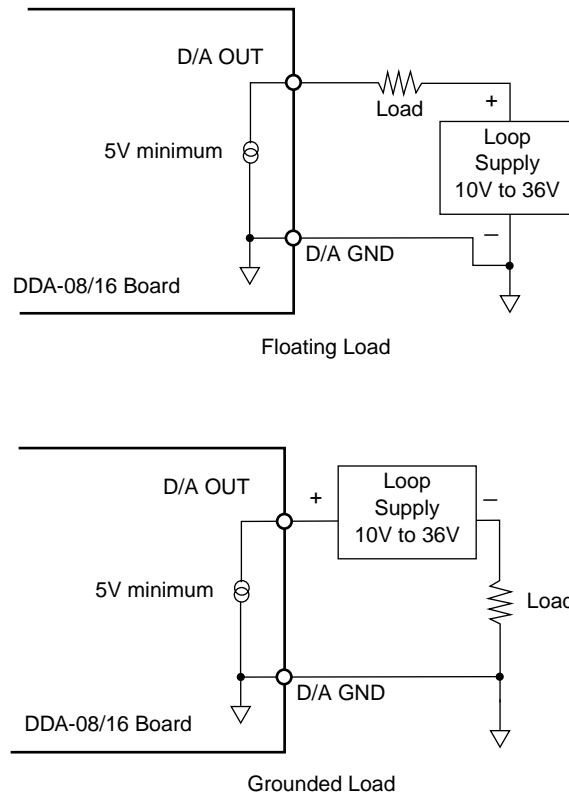

**Figure 4-6. Current Output**

# 5

## Subsystems and Analog I/O

The following sections describe how DriverLINX implements Digital Input Subsystem features and Analog Output Subsystem features for the DDA-08/16. Refer to *DriverLINX Installation and Configuration Guide* and *Using DriverLINX with Your Hardware, Keithley DDA-08/16* manuals for more information.

### Digital Input Subsystem

---

#### Digital Input Operations

The DDA-08/16 supports two types of operation:

- **Initialize** — Aborts any active interrupt data-acquisition tasks and stops the clock. However, DriverLINX prevents one application from interfering with another application's data-acquisition tasks.
- **Message** — DriverLINX displays a pop-up dialog box for the user containing the text for the current DriverLINX error message.

#### Digital Input Timing Events

Timing Events specify how the hardware paces or clocks the reading of Digital Input samples. Because the DDA-08/16 does not have any digital input data channels, DriverLINX does not allow an application to create any independent tasks with the Digital Input Subsystem. Refer to *DriverLINX Installation and Configuration Guide* and *Using DriverLINX with Your Hardware, Keithley DDA-08/16* manuals for more information.

## Counter/Timer Subsystem

---

The DDA-08/16 has a simple counter/timer subsystem. It allows analog output pacing at rates from 0.004Hz to 50kHz. In addition, it can perform independent counter/timer tasks while the analog output subsystem is idle, such as frequency division and strobe generation.

Refer to *DriverLINX Installation and Configuration Guide* and *Using DriverLINX with Your Hardware, Keithley DDA-08/16* manuals for more information.

## Analog Output Subsystem

---

The DDA-08/16 has eight or sixteen 12-bit output DACs. DriverLINX maps these signals to Logical Channels. The Analog Output Subsystem has an internal pacer clock, which DriverLINX designates as Logical Channel 0 of the Counter/Timer subsystem.

The Analog Output Subsystem supports three modes: Polled, for single-value analog output samples; Interrupt, for buffered transfers using programmed I/O; and Other, for subsystem initialization and data conversion.

The Analog Output Subsystem supports the following DriverLINX operations:

- **Initialize** — Aborts all active analog output data-acquisition tasks.
- **Start** — Initiates a data-acquisition task using the Mode, Timing, Start, and Stop Events, the Logical Channels, and the Buffers application specified in the Service Request.
- **Status** — Reports the buffer position of the next sample that DriverLINX will write into a buffer.
- **Stop** — Terminates an analog output data-acquisition task.
- **Message** — DriverLINX displays a pop-up dialog box for the user containing the text for the current DriverLINX error message.

Analog Output Timing Events specify how the hardware paces or clocks the sample output. DriverLINX uses the Timing Event to program when the DDA-08/16 writes the next analog output sample to the DACs.

The DDA-08/16 allows applications to specify the analog channels using three techniques: Start Channel, to write analog data to a single channel; Start/Stop Channel Range, to write analog data to a consecutive range of channels; and Channel List, to write analog data to a list of channels. The DDA-08/16 board has individual gain switches for each channel. DriverLINX uses a gain code of zero for all switch settings.

DriverLINX supports both single-value analog output and buffered analog output.

- **For single-value output** — Specify the Number of buffers as **0** and the number of *Samples* as **1**. Use Polled mode and store the data in the *ioValue* Service Request property.
- **For buffered output** — Specify the Number of buffers from **1** to **256** and the number of *Samples* as desired.

An individual DriverLINX buffer may have any size as long as the buffer length holds an integral number of channel scans.

The DDA-08/16 offers both bipolar and unipolar analog output ranges.

Refer to *DriverLINX Installation and Configuration Guide* and *Using DriverLINX with Your Hardware, Keithley DDA-08/16* manuals for more information.

## Analog I/O Panel

---

The DriverLINX Analog I/O Panel is an application that demonstrates analog input/output using DriverLINX. With the Analog I/O Panel you can:

- Analyze analog signals using the simulated two-channel Oscilloscope.
- Measure analog voltages using the simulated Digital Volt Meter.
- Generate Sine, Square, and Triangle waves using the SST Signal Generator.
- Output DC Level voltages using the Level Control.

The Analog I/O Panel is useful for:

- Testing the DDA-08/16 DriverLINX installation and configuration.
- Verifying signal inputs to your DDA-08/16 board.
- Sending test signals to external devices.

To access this DriverLINX Analog I/O Panel:

1. Start the Analog I/O Panel with the “AIO Panel” item on the Windows start menu, and continue with the following steps:
2. Click the [...] button in the Driver Selection section.
3. Select the driver for your board using the *Open DriverLINX* dialog.
4. Click *OK*.
5. Select the Logical Device you want to operate by dragging the pointer in the Device Selection section. The Analog I/O Panel displays the Scope, Meter, SST, and Level control tabs, depending on the capabilities of your DDA-08/16 board.
6. The Scope uses two analog input channels, referred to as ChA and ChB. Drag the channel selectors in the AI Channel Mapping section to map them to different channel numbers.
7. The SST Signal Generator uses two analog output channels, referred to as ChA and ChB. Drag the channel selectors in the AO Channel Mapping section to map them to different channel numbers.

You can now select the Scope, Meter, SST, and Level Control tabs to operate your DDA-08/16 board.

## Test Panel Application

---

Depending upon the DriverLINX drivers you have installed on your system, you will have one or more of the following example applications:

- *Single-Value AI* for analog input
- *Single-Value AO* for analog output
- *PIO Panel* for digital input and output
- *CTM Test Bench* for counter/timer applications.

To access this DriverLINX Test Panel, select Test Panel with the “Test Panel” item on the Windows start menu.

# 6

## DriverLINX Calibration and Test Utilities

The DriverLINX Calibration and Test Utility Setup Panel allows you to calibrate DDA-08/16 boards and to test some simple functions of DDA-08/16 boards. Follow the DriverLINX online instructions. Refer to the *DriverLINX Installation and Configuration Guide* and *Using DriverLINX with Your Hardware, Keithley DDA-08/16* manuals for more information.

The following sections provide the information you need to calibrate DDA-08/16 boards and to test the functions of DDA-08/16 boards.

### Calibration

---

DDA-08/16 boards are calibrated in the factory and should not require calibration when shipped. It is recommended that you check and, if necessary, readjust the calibration of your DDA-08/16 board every six months to a year.

---

**Note:** The DDA-08/16 board is calibrated at the factory for *voltage mode*. If the board is to be used in *current mode*, it needs to be recalibrated.

---



## Equipment Required

You need the following equipment to calibrate a DDA-08/16 board:

- A digital multimeter accurate to 6½ digits on its ±10VDC range, such as the Keithley DMM Model 196.
- An STA-U screw terminal accessory and C-1800 cable, and STP-37 screw terminal panel and C-1800 cable, or an STC-37 screw terminal connector.
- A small screwdriver.

DriverLINX Calibration Utility will guide you through the calibration procedure. Before calibration, specify the following parameters in the setup panel to get the correct instructions:

- **Logical Device** — Board's device number, model, and address.
- **Accessory** — Connection method used to connect the board to the calibration stimulus.
- **Shorted channel** — Input channel to be “shorted” high to low.
- **Voltage Channel** — Input channel to use to apply the various calibration voltage levels.
- **Calibration range** — Input range to be calibrated.

---

**Note:** Do not attempt to calibrate a DDA-08/16 board unless your equipment is of the required accuracy.

---

## Potentiometers

DDA-08 boards contain 16 potentiometers (one offset and one gain potentiometer for each analog output channel); DDA-16 boards contain 32 potentiometers (one offset and one gain potentiometer for each analog output channel). You adjust the potentiometers when calibrating the board.

The locations of the potentiometers on the DDA-16 board are shown in Figure 6-1. Note that the potentiometers on a DDA-08 board are the same as the potentiometers on a DDA-16 except that the DDA-08 board does not contain the potentiometers for analog output channels 8 through 15.

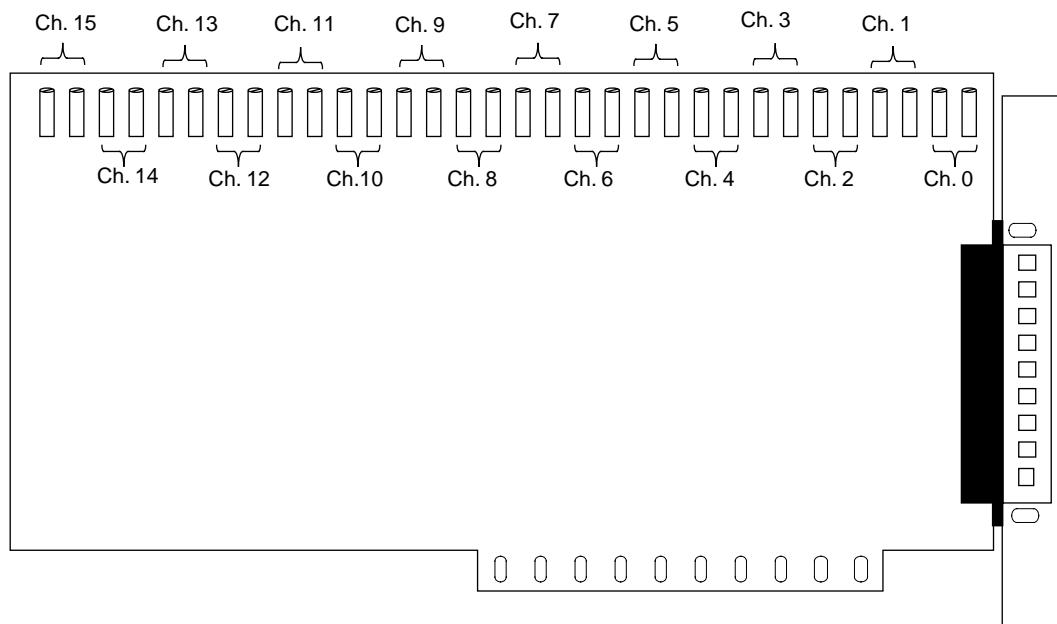

**Figure 6-1. Potentiometers (DDA-16)**

The potentiometers are labeled as shown in Table 6-1. Note that the DDA-08 board does not contain the potentiometers for analog output channels 8 through 15.

**Table 6-1. Potentiometers**

<b>Analog Output Channel</b>	<b>Offset Potentiometer Label</b>	<b>Gain Potentiometer Label</b>
0	R37	R38
1	R100	R99
2	R42	R41
3	R44	R43
4	R46	R45
5	R48	R102
6	R50	R101
7	R52	R51
8	R54	R53
9	R56	R55
10	R58	R57
11	R60	R59
12	R62	R61
13	R64	R104
14	R66	R103
15	R68	R67

The DriverLINX Calibration and Test Utility Setup Panel allows you to select a device to test or calibrate.

Click the Board text box, and select the device you want to calibrate. The configuration of your selected board will be displayed in the configuration box.

Select the Screw Terminal you are using in the calibration and test. The connection advice will be given according to the selected screw terminal. If you are using a screw terminal other than the selected one, be sure you measure the output of the right pin.

Select the “Calibrate” button on the Setup Panel for step by step instructions to calibrate each channel:

1. The Calibration Panel contains an illustration of the offset and gain potentiometers and instructions to adjust them.
2. Select a channel to calibrate from the “Channel to Calibrate” box.
3. Connect the positive and negative leads of a digital multimeter (DMM) to the specified pins on the DDA-08/16 main I/O connector (the positive lead to the D/A OUT pin of the analog output channel and the negative lead to pin 37).
4. At this time, D/A offset in the Calibration mode check box should be checked. If not, please check D/A offset first. Use a small screwdriver to turn the specified offset potentiometer until the multimeter shows the specified voltage or current (negative full scale).
5. When you have finished, check the D/A gain in the Calibration mode check box.
6. Use the screwdriver to turn the specified gain potentiometer until the multi-meter shows the specified voltage or current (positive full scale).
7. Repeat steps 2 through 6 for each analog output channel.
8. Click Back button to return to Setup Panel or Exit to exit the program.

---

**Note:** To ensure the accuracy of your board, make sure that you calibrate all analog output channels.

---

You can test the function of your DDA-08/16 board by updating an analog output channel with a specified value using DriverLINX.

To test a DDA-08/16 board, perform the following steps:

1. From the DriverLINX DDA-08/16 Calibration and Test Setup panel, click the Test button to display the Test Panel.
2. On the Test Panel, select the channel to test.
3. Specify the raw count equivalent of the output voltage (or current) for each channel you want to update by entering the output value in the binary code text box. As soon as you enter a new value, the analog output channel is immediately updated with the new value.
4. Follow the instructions in the right frames to measure the output.
5. Repeat steps 2 to 4 to test other channels.
6. Click the Back button to return to the Setup Panel or to exit the program.

Raw count values are between 0 and 4095. The value of a count value depends on the output range:

- For bipolar voltage output, a value of 0 corresponds to negative full scale, a value of 2048 corresponds to 0V, and a value of 4095 corresponds to positive full scale.
- For unipolar voltage output, a value of 0 corresponds to 0V and a value of 4095 corresponds to positive full scale.
- For current output, a value of 0 corresponds to 4mA and a value of 4095 corresponds to 20mA.

## Converting Voltage to Raw Counts

To convert a voltage output value to a raw count, use one of the following equations:

**Bipolar:**  $\text{Count} = [(V_{\text{out}} \times 4096) / \text{span}] + 2048$

**Unipolar:**  $\text{Count} = (V_{\text{out}} \times 4096) / \text{span}$

where  $V_{\text{out}}$  is the output voltage and span is the span of the output range.

---

**For example,** assume that you want to specify an output voltage of 3V for a DDA-16 that is set up for a  $\pm 5\text{V}$  bipolar output (10V span). The raw count is determined as:

$$[(3 \times 4096) / 10] + 2048 = 3277$$

---

## Converting Current to Raw Counts

To convert a current output value to a raw count, use the following equation:

$$\text{Count} = [(I_{\text{out}} \times 4096) / 16] - 1024$$

where  $I_{\text{out}}$  is the desired current (in milliamperes).

---

**For example,** assume that you want to specify an output current of 14mA for a DDA-16. The raw count is determined as:

$$[(14 \times 4096) / 16] - 1024 = 2560$$

---

# 7

## Troubleshooting

### Problem Isolation

---

If you encounter a problem with a DDA-08/16 board, use the instructions in this section to isolate the cause of the problem before calling Keithley for technical support.

### Using the DriverLINX Event Viewer

The DriverLINX Event Viewer displays the Windows system event log. Applications and hardware drivers make entries in the system event log to assist in predicting and troubleshooting hardware and software problems.

DriverLINX uses the event log to report problems during driver loading or unexpected system errors. The event log can assist in troubleshooting resource conflicts and DriverLINX configuration errors. If you are having trouble configuring or initializing a Logical Device, check the event log for information from the DriverLINX driver.

Using the DriverLINX Event Viewer, you can view, save, and e-mail DriverLINX event log entries under Windows 95/98 or Windows NT. DriverLINX event log entries can help you or technical support troubleshoot data-acquisition hardware and software problems.

## Device initialization error messages

During device initialization, DriverLINX performs a thorough test of all possible subsystems on DDA-08/16 boards as well as the computer interface. If DriverLINX detects any problems or unexpected responses, it reports an error message to help isolate the problem. The device initialization error messages fall into three basic categories:

- **Device not found** — Board address does not match hardware setting or conflicts with another board. Verify the board's address settings. Also, don't confuse hexadecimal with decimal addresses in the DriverLINX *Device Configuration* dialog box.
- **Invalid IRQ level or Invalid DMA level** — Selected level does not match hardware setting, conflicts with another board's IRQ/DMA levels, or is dedicated to the computer's internal functions (COM port, disk drive controller, network adapter, etc.)
- **Hardware does not match configuration** — Operating mode/range switch or jumper setting does not match selection(s) made in the DriverLINX *Device Configuration* dialog box.



If your DDA-08/16 board is not operating properly, use the information in this section to help you isolate the problem. If the problem appears serious enough to require technical support, refer to page 7-6 for information on how to contact an applications engineer.

## Identifying Symptoms and Possible Causes

---

Table 7-1 lists general symptoms and possible solutions for problems with DDA-08/16 boards. If your board is not operating properly after using this information, refer to page 7-6 for instructions on getting technical support.

**Table 7-1. Troubleshooting Information**

<b>Symptom</b>	<b>Possible Cause</b>	<b>Possible Solution</b>
Board does not respond	Base address is unacceptable.	Make sure that the base address specified in the configuration file matches the setting of the base address switch block on the board. Make sure that no other system resource is using any of the eight memory locations starting at the specified base address. Reconfigure the base address, if necessary. Refer to page 3-10 for instructions.

**Table 7-1. Troubleshooting Information (cont.)**

<b>Symptom</b>	<b>Possible Cause</b>	<b>Possible Solution</b>
Board does not respond (cont.)	Interrupt level is unacceptable.	Make sure that no other system resource is using the interrupt level specified in the configuration file.
	The board configuration is unacceptable.	Check the settings in the configuration file. Make sure that they match the settings of the switches on the board, where appropriate.
	The board is incorrectly aligned in the accessory slot.	Check installation.
	The board is damaged.	Contact Keithley Instruments, Inc., refer to page 7-6.
	The I/O bus speed is in excess of 8MHz.	Reduce I/O bus speed to a maximum of 8MHz. To change the I/O bus speed, run BIOS setup; refer to your computer documentation for instructions on running BIOS setup.
Intermittent operation	Vibrations or loose connections exist.	Cushion source of vibration and tighten connections.
	The board is overheating.	Check environmental and ambient temperature.
	Electrical noise exists.	Provide better shielding or reroute wiring.
	The I/O bus speed is in excess of 8MHz.	Reduce I/O bus speed to a maximum of 8MHz. To change the I/O bus speed, run BIOS setup; refer to your computer documentation for instructions on running BIOS setup.
System lockup	A timing error occurred.	Press [Ctrl] + [Break].

If you cannot identify the problem using the information in Table 7-1, refer to the next subsection to determine whether the problem is in the host computer or in the DDA-08/16 board.

## **Testing Board and Host Computer**

---

To determine whether the problem is in the host computer or in the DDA-08/16 board, perform the following steps:

1. Remove power connections to the host computer.
2. Unplug the accessory connector(s) or cable(s) from the DDA-08/16 board(s), keeping the connections intact on the accessory board(s).
3. Remove the DDA-08/16 board(s) from the computer and visually check for damage. If a board is obviously damaged, refer to page 7-6 for information on returning the board.
4. With the DDA-08/16 board(s) out of the computer, check the computer for proper operation. Power up the computer and perform any necessary diagnostics.

If you have another DDA-08/16 board that you know is functional, refer to the next section to determine whether the problem is in the accessory slot or in the I/O connections. If you do not have another board, refer to page 7-6 for information on how to contact an applications engineer.

## Testing Accessory Slot and I/O Connections

---

To determine whether the problem is in the accessory slot or in the I/O connections, perform the following steps:

1. When you are sure that the computer is operating properly, remove computer power again, and install a DDA-08/16 board that you know is functional. Do not make any I/O connections.
2. Apply computer power and check operation with the functional DDA-08/16 board in place. This test checks the computer accessory slot. If you are using more than one DDA-08/16 board, check the other slots you are using.
3. If the accessory slots are functional, check the I/O connections. Connect the accessory boards, one at a time, and check operation.
4. If operation is normal, the problem is in the DDA-08/16 board(s) originally in the computer. Try the DDA-08/16 board(s) one at a time in the computer to determine which is faulty.
5. If you cannot isolate the problem, refer to the next section for instructions on getting technical support.

## Technical Support

---

Before returning any equipment for repair, call Keithley for technical support at:

**1-888-KEITHLEY**  
**Monday - Friday, 8:00 a.m. – 6:00 p.m., Eastern Time**

An applications engineer will help you diagnose and resolve your problem over the telephone. Please make sure that you have the following information available before you call:

<b>DDA-08/16 board configuration</b>	Model	_____	
	Serial Number	_____	
	Revision Code	_____	
	Base address setting	_____	
	Interrupt level setting	_____	
	Number of channels	_____	
	Output signal (V or I)	_____	
	Mode (uni. or bip.)	_____	
	Output span	_____	
	Number SSH-8 boards	_____	
	Number EXP boards	_____	
	<b>Computer</b>	Manufacturer	_____
		CPU type	_____
Clock speed (MHz)		_____	
KB of RAM		_____	
Video system		_____	
<b>Operating system</b>	BIOS type	_____	
	Windows version	_____	
<b>Software package</b>	Windows mode	_____	
	Name	_____	
<b>Software package</b>	Serial Number	_____	
	Version	_____	
	Invoice/Order Number	_____	
	<b>Compiler (if applicable)</b>	Language	_____
Manufacturer		_____	
Version		_____	

<b>Accessories</b>	Type	_____
	Type	_____
	Type	_____
	Type	_____
	Type	_____
	Type	_____
	Type	_____
	Type	_____
	Type	_____

---

If a telephone resolution is not possible, the applications engineer will issue you a Return Material Authorization (RMA) number and ask you to return the equipment. Include the RMA number with any documentation regarding the equipment.

When returning equipment for repair, include the following information:

- Your name, address, and telephone number.
- The invoice or order number and date of equipment purchase.
- A description of the problem or its symptoms.
- The RMA number on the **outside** of the package.

Repackage the equipment, using the original anti-static wrapping, if possible, and handle it with ground protection. Ship the equipment to:

**ATTN.: RMA# \_\_\_\_\_**  
**Repair Department**  
**Keithley Instruments, Inc.**  
**28775 Aurora Road**  
**Cleveland, Ohio 44139**

**Telephone 1-888-KEITHLEY**  
**FAX (440) 248-6168**

---

**Note:** If you are submitting your equipment for repair under warranty, you must include the invoice number and date of purchase.

To enable Keithley to respond as quickly as possible, you must include the RMA number on the outside of the package.

---

# A

## Specifications

Table A-1 lists the specifications for the DDA-08/16 boards.

**Table A-1. DDA-08/16 Specifications**

Feature	Attribute	DDA-08/16 Specifications
Analog Output	Number of analog output channels	DDA-08: 8 DDA-16: 16
	Number of quad DACs	DDA-08: 2 DDA-16: 4
	Resolution	12 bits
	D/A converter type	Quad DAC4815 (4/2)
	Integral linearity	±1 bit
	Differential linearity	±1 bit
	Monotonicity	Guaranteed
	Temperature offset drift	15 ppm full scale range/°C, maximum
	Temperature gain drift	30 ppm full scale range/°C, maximum
	Voltage ranges <sup>1</sup>	0 to 10V 0 to 5V ±2.5V ±5V ±10V
	Current range <sup>1</sup>	4 to 20mA

<sup>1</sup>All analog output channels on a quad DAC must have the same voltage or current range.

**Table A-1. DDA-08/16 Specifications (cont.)**

<b>Feature</b>	<b>Attribute</b>	<b>DDA-08/16 Specifications</b>
Analog Output (cont.)	Load current	±15mA, minimum ±30mA, maximum
	Output resistance	0.1Ω, typical
	Settling time (to 0.01% full-scale step)	Less than 10μs (100pF), typical
	Load capacitance	Stable through 1μF
	Accuracy	Span: adjustable to 0 Offset: adjustable to 0
	At power-up	Unipolar output: ±3mV, maximum Bipolar output: ±20mV, maximum
	Simultaneous update	Include quad DACs in update group through software; specify the pacer clock through software
Pacer Clock	Sources	Hardware internal clock Hardware external clock
	Internal pacer clock Rate	1μs to 4.267 minutes (software-selectable)
	Prescaler value <sup>2</sup>	1μs, 10μs, 100μs, 1ms, 10ms, 100ms, 1s
	Counter value	0 to 255
	External pacer clock Polarity	Software-selectable
	Period	500ns, minimum

<sup>2</sup>The internal pacer clock and the output clock must use the same prescaler value.



**Table A-1. DDA-08/16 Specifications (cont.)**

Feature	Attribute	DDA-08/16 Specifications
Output clock	Time delay Prescaler value <sup>2</sup>	1μs, 10μs, 100μs, 1ms, 10ms, 100ms, 1s
	Counter value	0 to 255
	Polarity	Software-selectable
	Pulse length	∫ of prescaler value
Interrupt	Source	When channels are updated
	Levels	3, 5, 7, 10, 11, 15; software-selectable
Hardware trigger	Signal	Digital TTL
	Polarity	Software-selectable
	Period	500ns, minimum
Hardware gate	Signal	Digital TTL
	Polarity	Software-selectable
Power requirements	5V	320mA, typical 480mA, maximum
	±12V (with no load current)	DDA-08: 72mA, typical 100mA, maximum DDA-16: 132mA, typical 185mA, maximum
General	Operating temperature	0° to 50°C
	Storage temperature	-20° to 70°C
	Humidity	0 to 90%, noncondensing
	Dimensions	13.3 in. × 4.25 in. × 0.75 in. (33.8cm × 10.8cm × 1.9cm)
	Connector	37-pin, D-type

<sup>2</sup>The internal pacer clock and the output clock must use the same prescaler value.

# B

## Connector Pin Assignments

Figure B-1 shows the main I/O connector and its pin assignments on a DDA-16 board; Table B-1 contains a more detailed description of the pins. Note that the pin assignments on a DDA-08 board are the same as the pin assignments on a DDA-16 except that pins 12 through 19 and pins 30 through 37 are not used.

B-1

Top of Board (Rear View)

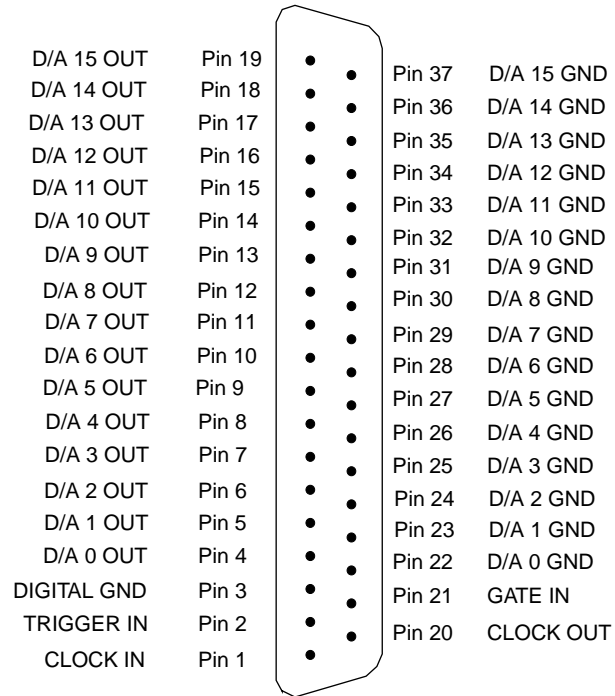

**Figure B-1. Main I/O Connector (DDA-16)**

**Table B-1. Main I/O Connector Pin Assignments for the DDA-16**

Pin	Name	Function
1	CLOCK IN	External pacer clock input
2	TRIGGER IN	External trigger input
3	DIGITAL GND	Digital ground
4	D/A 0 OUT	Voltage/current output for channel 0
5	D/A 1 OUT	Voltage/current output for channel 1
6	D/A 2 OUT	Voltage/current output for channel 2
7	D/A 3 OUT	Voltage/current output for channel 3
8	D/A 4 OUT	Voltage/current output for channel 4
9	D/A 5 OUT	Voltage/current output for channel 5
10	D/A 6 OUT	Voltage/current output for channel 6
11	D/A 7 OUT	Voltage/current output for channel 7
12	D/A 8 OUT	Voltage/current output for channel 8
13	D/A 9 OUT	Voltage/current output for channel 9
14	D/A 10 OUT	Voltage/current output for channel 10
15	D/A 11 OUT	Voltage/current output for channel 11
16	D/A 12 OUT	Voltage/current output for channel 12
17	D/A 13 OUT	Voltage/current output for channel 13
18	D/A 14 OUT	Voltage/current output for channel 14
19	D/A 15 OUT	Voltage/current output for channel 15
20	CLOCK OUT	Output clock pulse output
21	GATE IN	Hardware gate input
22	D/A 0 GND	Analog output ground for channel 0
23	D/A 1 GND	Analog output ground for channel 1
24	D/A 2 GND	Analog output ground for channel 2
25	D/A 3 GND	Analog output ground for channel 3
26	D/A 4 GND	Analog output ground for channel 4

**Table B-1. Main I/O Connector Pin Assignments for the DDA-16 (cont.)**

<b>Pin</b>	<b>Name</b>	<b>Function</b>
27	D/A 5 GND	Analog output ground for channel 5
28	D/A 6 GND	Analog output ground for channel 6
29	D/A 7 GND	Analog output ground for channel 7
30	D/A 8 GND	Analog output ground for channel 8
31	D/A 9 GND	Analog output ground for channel 9
32	D/A 10 GND	Analog output ground for channel 10
33	D/A 11 GND	Analog output ground for channel 11
34	D/A 12 GND	Analog output ground for channel 12
35	D/A 13 GND	Analog output ground for channel 13
36	D/A 14 GND	Analog output ground for channel 14
37	D/A 15 GND	Analog output ground for channel 15

# Index

## A

- accessories 1-3
  - attaching 4-1
  - C-1800 cable 1-3, 4-4, 4-5
  - S-1800 cable 1-3, 4-4, 4-5
  - STA-U screw terminal accessory 1-3, 4-4
  - STC-37 screw terminal connector 1-3, 4-3
  - STP-37 screw terminal panel 1-3, 4-5
- Acrobat
  - for DriverLINX installation 3-4
- active edge: *see* edge
- address
  - configuration in DriverLINX 3-20
- analog I/O panel
  - in DriverLINX 5-3
- analog output channels 2-3
- analog output range
  - configuration in DriverLINX 3-20
  - set before configuration 3-6
- analog output ranges: *see* output ranges
- analog output subsystem
  - in DriverLINX 5-1
- attaching
  - STA-U screw terminal accessory 4-4
  - STC-37 screw terminal connector 4-3
  - STP-37 screw terminal panel 4-5

## B

- base address
  - default 3-10
  - set before configuration 3-6
- base address switch 3-10
- bipolar output, selecting 3-16
- block diagram 2-2
- board
  - configuration 3-6
  - inspection 3-1
  - switches: *see* switches
- browser map
  - DriverLINX installation 3-5
- buffer: *see* input buffer, PC memory buffer
- buffered analog output 5-3

## C

- C/C++
  - application program 1-2
- C-1800 cable 1-3, 4-4, 4-5
- cables 1-3
  - C-1800 1-3, 4-4, 4-5
  - S-1800 1-3, 4-4, 4-5
- cache
  - disabling for software installation 3-2
- calibration
  - using DriverLINX utility 6-1
  - when using current mode 3-3, 6-1
- CD ROM
  - DriverLINX installation 3-5

- channel
  - channel list
    - in analog output 5-3
  - multiple
    - in multi-channel mode 2-3
  - start channel
    - in analog output 5-3
  - start/stop channel range
    - in analog output 5-3
- channels, analog output 2-3
- clock source
  - specifying in DriverLINX 2-6
- clock tic
  - specifying in DriverLINX 2-6
- clocks: *see* output clock, pacer clocks
- compiler
  - required for supporting Windows development 1-1
- computer
  - needed for DDA-08/16 and DriverLINX 1-1
- computer resources
  - determination for installation 3-4
- configuration
  - options 3-6, 3-7
  - using DriverLINX 3-6, 3-19
- configuring a board 3-6
- connecting signals 4-6
- connector, main I/O 4-1
  - pin assignments 4-2, B-2
- counter/timer
  - configuration in DriverLINX 3-20
  - subsystem in DriverLINX 5-1, 5-2
- current mode
  - need for calibration when using 1-3, 3-3
- current output 2-5
  - connecting signal 4-7
  - converting to raw count 6-7

## D

- D/A offset
  - calibration of 6-5
- DACs: *see* quad DACs
- DDA-08/16
  - description of 1-1
  - DDA-08/16 standard software package 1-2
  - installing 3-4
- default configuration file
  - settings 3-7
- delay
  - start event property 2-9
- Delphi
  - application program 1-2
- device
  - menu in DriverLINX 3-19
- digital input signal
  - external
    - used to pace output 2-11
- digital input subsystem
  - in DriverLINX 5-1
- digital-to-analog converters: *see* quad DACs
- DriverLINX
  - analog I/O panel 3-2
    - description 1-2
  - analog output subsystem 5-2
  - API DLLs 3-2
    - description 1-2
  - configuration with 3-6, 3-19
  - digital input subsystem 5-1
  - event viewer 7-1
  - installing and configuring 3-2
  - software for DDA-08/16 1-2
  - test panel 5-5
  - timing events 2-11
  - using to verify board operation 3-20
- drivers
  - installing for applications 3-4

## **E**

- edge
  - external pacer clock 2-7
  - gate 2-13
  - output clock 2-8
  - trigger 2-11
- error messages
  - device initialization 7-2
- event log
  - used to detect errors 7-1
- event viewer
  - in DriverLINX 7-1
- external pacer clock 2-7, 2-12, 2-13

## **G**

- gain
  - calibration of 6-5
- gate 2-13, 2-14
  - property affecting sampling 2-14
  - specifying in DriverLINX 2-6

## **H**

- handling a board 3-1

## **I**

- initialize
  - analog output operation 5-2
  - digital input operation 5-1
- input buffer 2-3
- inspecting a board 3-1

- interfaces
  - installing for applications 3-5
- internal pacer clock 2-6, 2-11, 2-13
- interrupt level
  - set before configuration 3-6
- interrupts 2-15

## **L**

- Learn DriverLINX
  - description 1-2
  - using for configuration 3-19
- level control
  - in analog I/O panel 5-3
- logical channel
  - used for pacer clock and output clock 2-6
- logical device
  - configuration in DriverLINX 3-19

## **M**

- manuals
  - DriverLINX 3-5
- mask
  - start event property 2-9
- memory
  - requirement for computer 1-1
- message
  - analog output operation 5-2
  - digital input operation 5-1
- Microsoft Windows
  - versions supported 1-1



- mode
  - interrupt
    - in analog output 5-2
  - other
    - in analog output 5-2
  - polled
    - in analog output 5-2
    - single-value output 5-3
  - specifying in DriverLINX 2-6
- multi-channel mode
  - consecutive range of analog channels in 2-3
  - random list of analog channels in 2-3
- multimeter
  - required for calibration 6-2

## O

- oscilloscope
  - in analog I/O panel 5-3
- output clock 2-8, 2-10
- output pulse length 2-10
- output range type switch 3-15
- output ranges 2-4
  - setting 3-12
  - summary of switches 3-13
- output signal switches 3-14
- output span switch 3-17

## P

- pacer clocks 2-7
  - see also* external pacer clock, internal pacer clock
- pacing
  - of analog output 5-2
- pattern
  - start event property 2-9

- period
  - interval between samples 2-14
- pin assignments 4-2, B-2
- polarity: *see* edge
- post-trigger
  - used in DriverLINX for synchronization of data 2-9
- potentiometer
  - in calibration utility 6-5
- potentiometers 6-3
- power-up settings
  - external pacer clock edge 2-7
  - interrupts 2-15
  - output clock pulse edge 2-8
  - output values 2-5
  - pacer clock 2-8
  - trigger edge 2-11
- prescaler value 2-6, 2-8, 2-10
- problem isolation 7-3

## Q

- quad DACs 2-3

## R

- ranges, output 2-4
- rate
  - analog output 2-11
  - generator
    - used to pace output samples 2-14
- rate, update 2-6, 2-8
- raw count
  - converting to voltage 6-7
  - output range
    - in test panel 6-6
- resolution 2-5
- RMA
  - obtaining for material return 7-8

## S

- S-1800 cable 1-3, 4-4, 4-5
- screw terminal accessory
  - required for calibration 6-2
- shipping instructions
  - for returning material 7-8
- signal generator
  - in analog I/O panel 5-3
- signals
  - connecting 4-6
- simultaneous update 2-3
- single-value output
  - in analog output 5-3
- slot size 3-18
- specifications A-1
- start
  - analog output operation 5-2
- status
  - analog output operation 5-2
- STA-U screw terminal accessory 1-3
  - attaching 4-4
- STC-37 screw terminal connector 1-3
  - attaching 4-3
- stop
  - analog output operation 5-2
- STP-37 screw terminal panel 1-3
  - attaching 4-5
- switches 3-8, 3-9
  - base address 3-10
  - current output 3-15, 3-17
  - output range type 3-15
  - output signal 3-14
  - output span 3-17
  - setting output range 3-13
  - setting prior to installation 3-4
- synchronizing devices 2-8

## T

- technical support
  - instructions for using 7-6
- test button
  - on test panel in DriverLINX 6-6
- test panel
  - in DriverLINX 5-5
- test setup
  - in DriverLINX 6-6
- TestPoint
  - application program 1-2
- time delay (output clock) 2-8
- timing event
  - analog output 5-3
  - digital input 5-1
  - used to pace output 2-11
- trigger 2-11, 2-12
  - related to analog output samples 2-9
- troubleshooting 7-3

## U

- unipolar output, selecting 3-15
- unpacking a board 3-1
- update clock: *see* pacer clocks
- update group 2-3
- update rate 2-6, 2-8
- updating analog output channels 2-3
- utilities
  - calibration and test 6-1
  - description 1-3
  - DriverLINX Test Panel
    - description 1-3
    - included in standard software package 1-3

## **V**

verify

- board operation

  - using DriverLINX 3-20

Visual Basic

- application program 1-2

volt meter

- in analog I/O panel 5-3

voltage output 2-4

- connecting signal 4-6

- in analog I/O panel 5-3

## **W**

wiring signals 4-6

Specifications are subject to change without notice.

All Keithley trademarks and trade names are the property of Keithley Instruments, Inc. All other trademarks and trade names are the property of their respective companies.



**Keithley Instruments, Inc.**

28775 Aurora Road • Cleveland, Ohio 44139 • 440-248-0400 • Fax: 440-248-6168  
1-888-KEITHLEY (534-8453) • [www.keithley.com](http://www.keithley.com)

**Sales Offices:**

**BELGIUM:** Bergensesteenweg 709 • B-1600 Sint-Pieters-Leeuw • 02-363 00 40 • Fax: 02/363 00 64  
**CHINA:** Yuan Chen Xin Building, Room 705 • 12 Yumin Road, Dewai, Madian • Beijing 100029 • 8610-6202-2886 • Fax: 8610-6202-2892  
**FINLAND:** Tietäjäsentie 2 • 02130 Espoo • Phone: 09-54 75 08 10 • Fax: 09-25 10 51 00  
**FRANCE:** 3, allée des Garays • 91127 Palaiseau Cédex • 01-64 53 20 20 • Fax: 01-60 11 77 26  
**GERMANY:** Landsberger Strasse 65 • 82110 Germering • 089/84 93 07-40 • Fax: 089/84 93 07-34  
**GREAT BRITAIN:** Unit 2 Commerce Park, Brunel Road • Theale • Berkshire RG7 4AB • 0118 929 7500 • Fax: 0118 929 7519  
**INDIA:** Flat 2B, Willocrissa • 14, Rest House Crescent • Bangalore 560 001 • 91-80-509-1320/21 • Fax: 91-80-509-1322  
**ITALY:** Viale San Gimignano, 38 • 20146 Milano • 02-48 39 16 01 • Fax: 02-48 30 22 74  
**JAPAN:** New Pier Takeshiba North Tower 13F • 11-1, Kaigan 1-chome • Minato-ku, Tokyo 105-0022 • 81-3-5733-7555 • Fax: 81-3-5733-7556  
**KOREA:** 2FL., URI Building • 2-14 Yangjae-Dong • Seocho-Gu, Seoul 137-888 • 82-2-574-7778 • Fax: 82-2-574-7838  
**NETHERLANDS:** Postbus 559 • 4200 AN Gorinchem • 0183-635333 • Fax: 0183-630821  
**SWEDEN:** c/o Regus Business Centre • Frosundaviks Allé 15, 4tr • 169 70 Solna • 08-509 04 679 • Fax: 08-655 26 10  
**SWITZERLAND:** Kriesbachstrasse 4 • 8600 Dübendorf • 01-821 94 44 • Fax: 01-820 30 81  
**TAIWAN:** 1FL., 85 Po Ai Street • Hsinchu, Taiwan, R.O.C. • 886-3-572-9077 • Fax: 886-3-572-9031

© Copyright 2001 Keithley Instruments, Inc.  
Printed in the U.S.A.  
4/02



## Artisan Technology Group is your source for quality new and certified-used/pre-owned equipment

- FAST SHIPPING AND DELIVERY
- TENS OF THOUSANDS OF IN-STOCK ITEMS
- EQUIPMENT DEMOS
- HUNDREDS OF MANUFACTURERS SUPPORTED
- LEASING/MONTHLY RENTALS
- ITAR CERTIFIED SECURE ASSET SOLUTIONS

### SERVICE CENTER REPAIRS

Experienced engineers and technicians on staff at our full-service, in-house repair center

### *InstraView*<sup>SM</sup> REMOTE INSPECTION

Remotely inspect equipment before purchasing with our interactive website at [www.instraview.com](http://www.instraview.com) ↗

### WE BUY USED EQUIPMENT

Sell your excess, underutilized, and idle used equipment. We also offer credit for buy-backs and trade-ins. [www.artisanng.com/WeBuyEquipment](http://www.artisanng.com/WeBuyEquipment) ↗

### LOOKING FOR MORE INFORMATION?

Visit us on the web at [www.artisanng.com](http://www.artisanng.com) ↗ for more information on price quotations, drivers, technical specifications, manuals, and documentation

**Contact us:** (888) 88-SOURCE | [sales@artisanng.com](mailto:sales@artisanng.com) | [www.artisanng.com](http://www.artisanng.com)