



Artisan Technology Group is your source for quality new and certified-used/pre-owned equipment

- FAST SHIPPING AND DELIVERY
- TENS OF THOUSANDS OF IN-STOCK ITEMS
- EQUIPMENT DEMOS
- HUNDREDS OF MANUFACTURERS SUPPORTED
- LEASING/MONTHLY RENTALS
- ITAR CERTIFIED SECURE ASSET SOLUTIONS

SERVICE CENTER REPAIRS

Experienced engineers and technicians on staff at our full-service, in-house repair center

*InstraView*SM REMOTE INSPECTION

Remotely inspect equipment before purchasing with our interactive website at www.instraview.com ↗

WE BUY USED EQUIPMENT

Sell your excess, underutilized, and idle used equipment. We also offer credit for buy-backs and trade-ins. www.artisanng.com/WeBuyEquipment ↗

LOOKING FOR MORE INFORMATION?

Visit us on the web at www.artisanng.com ↗ for more information on price quotations, drivers, technical specifications, manuals, and documentation

Contact us: (888) 88-SOURCE | sales@artisanng.com | www.artisanng.com



SSIO-24 Digital I/O Board

User Guide

A large, faint, light gray graphic in the background of the page. It appears to be a stylized, hand-drawn or brush-painted shape, possibly representing a hand or a specific symbol, with several irregular, blob-like shapes above it.

A GREATER MEASURE OF CONFIDENCE

WARRANTY

Hardware

Keithley Instruments, Inc. warrants that, for a period of one (1) year from the date of shipment (3 years for Models 2000, 2001, 2002, 2010 and 2700), the Keithley Hardware product will be free from defects in materials or workmanship. This warranty will be honored provided the defect has not been caused by use of the Keithley Hardware not in accordance with the instructions for the product. This warranty shall be null and void upon: (1) any modification of Keithley Hardware that is made by other than Keithley and not approved in writing by Keithley or (2) operation of the Keithley Hardware outside of the environmental specifications therefore.

Upon receiving notification of a defect in the Keithley Hardware during the warranty period, Keithley will, at its option, either repair or replace such Keithley Hardware. During the first ninety days of the warranty period, Keithley will, at its option, supply the necessary on site labor to return the product to the condition prior to the notification of a defect. Failure to notify Keithley of a defect during the warranty shall relieve Keithley of its obligations and liabilities under this warranty.

Other Hardware

The portion of the product that is not manufactured by Keithley (Other Hardware) shall not be covered by this warranty, and Keithley shall have no duty of obligation to enforce any manufacturers' warranties on behalf of the customer. On those other manufacturers' products that Keithley purchases for resale, Keithley shall have no duty of obligation to enforce any manufacturers' warranties on behalf of the customer.

Software

Keithley warrants that for a period of one (1) year from date of shipment, the Keithley produced portion of the software or firmware (Keithley Software) will conform in all material respects with the published specifications provided such Keithley Software is used on the product for which it is intended and otherwise in accordance with the instructions therefore. Keithley does not warrant that operation of the Keithley Software will be uninterrupted or error-free and/or that the Keithley Software will be adequate for the customer's intended application and/or use. This warranty shall be null and void upon any modification of the Keithley Software that is made by other than Keithley and not approved in writing by Keithley.

If Keithley receives notification of a Keithley Software nonconformity that is covered by this warranty during the warranty period, Keithley will review the conditions described in such notice. Such notice must state the published specification(s) to which the Keithley Software fails to conform and the manner in which the Keithley Software fails to conform to such published specification(s) with sufficient specificity to permit Keithley to correct such nonconformity. If Keithley determines that the Keithley Software does not conform with the published specifications, Keithley will, at its option, provide either the programming services necessary to correct such nonconformity or develop a program change to bypass such nonconformity in the Keithley Software. Failure to notify Keithley of a nonconformity during the warranty shall relieve Keithley of its obligations and liabilities under this warranty.

Other Software

OEM software that is not produced by Keithley (Other Software) shall not be covered by this warranty, and Keithley shall have no duty or obligation to enforce any OEM's warranties on behalf of the customer.

Other Items

Keithley warrants the following items for 90 days from the date of shipment: probes, cables, rechargeable batteries, diskettes, and documentation.

Items not Covered under Warranty

This warranty does not apply to fuses, non-rechargeable batteries, damage from battery leakage, or problems arising from normal wear or failure to follow instructions.

Limitation of Warranty

This warranty does not apply to defects resulting from product modification made by Purchaser without Keithley's express written consent, or by misuse of any product or part.

Disclaimer of Warranties

EXCEPT FOR THE EXPRESS WARRANTIES ABOVE KEITHLEY DISCLAIMS ALL OTHER WARRANTIES, EXPRESS OR IMPLIED, INCLUDING WITHOUT LIMITATION, ALL IMPLIED WARRANTIES OF MERCHANTABILITY AND FITNESS FOR A PARTICULAR PURPOSE. KEITHLEY DISCLAIMS ALL WARRANTIES WITH RESPECT TO THE OTHER HARDWARE AND OTHER SOFTWARE.

Limitation of Liability

KEITHLEY INSTRUMENTS SHALL IN NO EVENT, REGARDLESS OF CAUSE, ASSUME RESPONSIBILITY FOR OR BE LIABLE FOR: (1) ECONOMICAL, INCIDENTAL, CONSEQUENTIAL, INDIRECT, SPECIAL, PUNITIVE OR EXEMPLARY DAMAGES, WHETHER CLAIMED UNDER CONTRACT, TORT OR ANY OTHER LEGAL THEORY, (2) LOSS OF OR DAMAGE TO THE CUSTOMER'S DATA OR PROGRAMMING, OR (3) PENALTIES OR PENALTY CLAUSES OF ANY DESCRIPTION OR INDEMNIFICATION OF THE CUSTOMER OR OTHERS FOR COSTS, DAMAGES, OR EXPENSES RELATED TO THE GOODS OR SERVICES PROVIDED UNDER THIS WARRANTY.

KEITHLEY

Keithley Instruments, Inc. 28775 Aurora Road • Cleveland, Ohio 44139 • 440-248-0400 • Fax: 440-248-6168
1-888-KEITHLEY (534-8453) • www.keithley.com

Sales Offices: BELGIUM: Bergensesteenweg 709 • B-1600 Sint-Pieters-Leeuw • 02-363 00 40 • Fax: 02/363 00 64
CHINA: Yuan Chen Xin Building, Room 705 • 12 Yumin Road, Dewai, Madian • Beijing 100029 • 8610-6202-2886 • Fax: 8610-6202-2892
FINLAND: Tietijantie 2 • 02130 Espoo • Phone: 09-54 75 08 10 • Fax: 09-25 10 51 00
FRANCE: 3, allée des Garays • 91127 Palaiseau Cédex • 01-64 53 20 20 • Fax: 01-60 11 77 26
GERMANY: Landsberger Strasse 65 • 82110 Germering • 089/84 93 07-40 • Fax: 089/84 93 07-34
GREAT BRITAIN: Unit 2 Commerce Park, Brunel Road • Theale • Berkshire RG7 4AB • 0118 929 7500 • Fax: 0118 929 7519
INDIA: Flat 2B, Willocrissa • 14, Rest House Crescent • Bangalore 560 001 • 91-80-509-1320/21 • Fax: 91-80-509-1322
ITALY: Viale San Gimignano, 38 • 20146 Milano • 02-48 39 16 01 • Fax: 02-48 30 22 74
JAPAN: New Pier Takeshiba North Tower 13F • 11-1, Kaigan 1-chome • Minato-ku, Tokyo 105-0022 • 81-3-5733-7555 • Fax: 81-3-5733-7556
KOREA: 2FL., URI Building • 2-14 Yangjae-Dong • Seocho-Gu, Seoul 137-888 • 82-2-574-7778 • Fax: 82-2-574-7838
NETHERLANDS: Postbus 559 • 4200 AN Gorinchem • 0183-635333 • Fax: 0183-630821
SWEDEN: c/o Regus Business Centre • Frosundaviks Allé 15, 4tr • 169 70 Solna • 08-509 04 679 • Fax: 08-655 26 10
SWITZERLAND: Kriesbachstrasse 4 • 8600 Dübendorf • 01-821 94 44 • Fax: 01-820 30 81
TAIWAN: 1FL., 85 Po Ai Street • Hsinchu, Taiwan, R.O.C. • 886-3-572-9077 • Fax: 886-3-572-9031

User Guide

for the

SSIO-24 Digital I/O Board

Revision C – August 2002
Copyright © Keithley Data Acquisition 1991
Part Number: 81250

Keithley Instruments, Inc.
28775 Aurora Road, Cleveland, OH 44139
(440) 248-0400 • Fax: (440) 248-6168

- iii -

Basic™ is a trademark of Dartmouth College.

IBM® is a registered trademark of International Business Machines Corporation.

PC, XT, and AT® are trademarks of International Business Machines Corporation.

Microsoft® is a registered trademark of Microsoft Corporation.

Turbo C® is a registered trademark of Borland International.

DriverLINX is a registered trademark of Scientific Software Tools, Inc.

All other brand and product names are trademarks or registered trademarks of their respective companies.

Information furnished by Keithley Instruments is believed to be accurate and reliable. However, Keithley Instruments assumes no responsibility for the use of such information nor for any infringements of patents or other rights of third parties that may result from its use. No license is granted by implication or otherwise under any patent rights of Keithley Instruments.

WARNING

Keithley Instruments assumes no responsibility for damages consequent to the use of this product. This product is not designed with components of a level of reliability suitable for use in life support or critical applications.

The following safety precautions should be observed before using this product and any associated instrumentation. Although some instruments and accessories would normally be used with non-hazardous voltages, there are situations where hazardous conditions may be present.

This product is intended for use by qualified personnel who recognize shock hazards and are familiar with the safety precautions required to avoid possible injury. Read and follow all installation, operation, and maintenance information carefully before using the product. Refer to the manual for complete product specifications.

If the product is used in a manner not specified, the protection provided by the product may be impaired.

The types of product users are:

Responsible body is the individual or group responsible for the use and maintenance of equipment, for ensuring that the equipment is operated within its specifications and operating limits, and for ensuring that operators are adequately trained.

Operators use the product for its intended function. They must be trained in electrical safety procedures and proper use of the instrument. They must be protected from electric shock and contact with hazardous live circuits.

Maintenance personnel perform routine procedures on the product to keep it operating properly, for example, setting the line voltage or replacing consumable materials. Maintenance procedures are described in the manual. The procedures explicitly state if the operator may perform them. Otherwise, they should be performed only by service personnel.

Service personnel are trained to work on live circuits, and perform safe installations and repairs of products. Only properly trained service personnel may perform installation and service procedures.

Keithley products are designed for use with electrical signals that are rated Installation Category I and Installation Category II, as described in the International Electrotechnical Commission (IEC) Standard IEC 60664. Most measurement, control, and data I/O signals are Installation Category I and must not be directly connected to mains voltage or to voltage sources with high transient over-voltages. Installation Category II connections require protection for high transient over-voltages often associated with local AC mains connections. Assume all measurement, control, and data I/O connections are for connection to Category I sources unless otherwise marked or described in the Manual.

Exercise extreme caution when a shock hazard is present. Lethal voltage may be present on cable connector jacks or test fixtures. The American National Standards Institute (ANSI) states that a shock hazard exists when voltage levels greater than 30V RMS, 42.4V peak, or 60VDC are present. **A good safety practice is to expect that hazardous voltage is present in any unknown circuit before measuring.**

Operators of this product must be protected from electric shock at all times. The responsible body must ensure that operators are prevented access and/or insulated from every connection point. In some cases, connections must be exposed to potential human contact. Product operators in these circumstances must be trained to protect themselves from the risk of electric shock. If the circuit is capable of operating at or above 1000 volts, **no conductive part of the circuit may be exposed.**

Do not connect switching cards directly to unlimited power circuits. They are intended to be used with impedance limited sources. NEVER connect switching cards directly to AC mains. When connecting sources to switching cards, install protective devices to limit fault current and voltage to the card.

Before operating an instrument, make sure the line cord is connected to a properly grounded power receptacle. Inspect the connecting cables, test leads, and jumpers for possible wear, cracks, or breaks before each use.

When installing equipment where access to the main power cord is restricted, such as rack mounting, a separate main input power disconnect device must be provided, in close proximity to the equipment and within easy reach of the operator.

For maximum safety, do not touch the product, test cables, or any other instruments while power is applied to the circuit under test. ALWAYS remove power from the entire test system and discharge any capacitors before: connecting or disconnecting cables or jumpers, installing or removing switching cards, or making internal changes, such as installing or removing jumpers.

Do not touch any object that could provide a current path to the common side of the circuit under test or power line (earth) ground. Always make measurements with dry hands while standing on a dry, insulated surface capable of withstanding the voltage being measured.



The instrument and accessories must be used in accordance with its specifications and operating instructions or the safety of the equipment may be impaired.

Do not exceed the maximum signal levels of the instruments and accessories, as defined in the specifications and operating information, and as shown on the instrument or test fixture panels, or switching card.

When fuses are used in a product, replace with same type and rating for continued protection against fire hazard.

Chassis connections must only be used as shield connections for measuring circuits, NOT as safety earth ground connections.

If you are using a test fixture, keep the lid closed while power is applied to the device under test. Safe operation requires the use of a lid interlock.

If  or  is present, connect it to safety earth ground using the wire recommended in the user documentation.

The  symbol on an instrument indicates that the user should refer to the operating instructions located in the manual.

The  symbol on an instrument shows that it can source or measure 1000 volts or more, including the combined effect of normal and common mode voltages. Use standard safety precautions to avoid personal contact with these voltages.

The **WARNING** heading in a manual explains dangers that might result in personal injury or death. Always read the associated information very carefully before performing the indicated procedure.

The **CAUTION** heading in a manual explains hazards that could damage the instrument. Such damage may invalidate the warranty.

Instrumentation and accessories shall not be connected to humans.

Before performing any maintenance, disconnect the line cord and all test cables.

To maintain protection from electric shock and fire, replacement components in mains circuits, including the power transformer, test leads, and input jacks, must be purchased from Keithley Instruments. Standard fuses, with applicable national safety approvals, may be used if the rating and type are the same. Other components that are not safety related may be purchased from other suppliers as long as they are equivalent to the original component. (Note that selected parts should be purchased only through Keithley Instruments to maintain accuracy and functionality of the product.) If you are unsure about the applicability of a replacement component, call a Keithley Instruments office for information.

To clean an instrument, use a damp cloth or mild, water based cleaner. Clean the exterior of the instrument only. Do not apply cleaner directly to the instrument or allow liquids to enter or spill on the instrument. Products that consist of a circuit board with no case or chassis (e.g., data acquisition board for installation into a computer) should never require cleaning if handled according to instructions. If the board becomes contaminated and operation is affected, the board should be returned to the factory for proper cleaning/servicing.

Contents

CHAPTER 1: INTRODUCTION

1.1	Overview	1-1
1.2	Specifications	1-1
1.3	Accessories	1-2

CHAPTER 2: INSTALLATION

2.1	Overview	2-1
2.2	Terminal Block TB7	2-1
2.3	Port Direction Switch S1	2-3
2.4	Mode Selection Block J3	2-4
2.5	Installation	2-6
2.6	Connector Pin Assignments	2-8

CHAPTER 3: PROGRAMMING

3.1	Overview	3-1
3.2	Examples	3-1

CHAPTER 4: FACTORY RETURNS

4.1	Fuse Replacement	4-1
4.2	Return Requirements	4-1



INTRODUCTION

1.1 OVERVIEW

The SSIO-24 is a digital I/O board with accommodations for up to 24 optically isolated solid-state I/O modules, which plug into plated holes for firm seating and for efficient electrical contact. Both the mechanical and electrical layout of the plated holes arranges a full complement of modules into four banks, as follows: two banks of eight modules and two banks of four. This arrangement allows the use of modules in any combination of 8-8-4-4.

For control of the SSIO-24, use any one of the Keithley MetraByte Parallel I/O Digital Interface Products (PIO-12, PIO-24, uCPIO-24, uCPIO-12, PIO-96, uPIO-72). Set the interface direction via the port-direction DIP switch located at the front of the Board.

The Board is 19" rack-mountable with an optional RMT-02 adapter, or it mounts on any flat panel or other flat surface.

To identify module activity, each module location contains a status-indicator LED. For applications requiring power beyond the normal capacity of the computer power supply, the Board contains an auxiliary power supply connector. The Board also has fuse protection for each I/O channel and includes power-up/power-down supervisory circuitry to ensure off status of the output modules during these transitions.

1.2 SPECIFICATIONS

Number of I/O Channels 24

Power Consumption (+5 V)

<i>Without Modules *</i>	180 mA (max.)	115 mA (typ.)
<i>With Modules</i>	610 mA (max.)	270 mA (typ.)

Environmental
Operating Temperature 0 to 70° C
Storage Temperature -40 to 100° C

Dimensions 16.00" x 4.75"
 (40.64 cm x 12.07
 cm)

* This is the minimum current draw from the PC, whether or not an external power supply is used for the SSIO-24.

1.3 ACCESSORIES

PART NUMBER	DESCRIPTION
SM-ODC5	3-60 VDC Output Module
SM-OAC5	12-140 VAC Output Module
SM-IAC5	90-140 VAC Input Module
SM-IDC5	3.3-32 VDC Input Module
CACC-2000	PIO-96 Cable
C-1800	Standard cable. This cable is 1.5' long. To order the same interface cable in different lengths, specify C-18XX where xx is the length in feet. For example, for a cable 10.5' long, you would specify C-1809.
RMT-02	Rack-mountable enclosure; installs into any standard 19" rack (such as a Keithley MetraByte RMF-06 or RTT-02).



INSTALLATION

2.1 OVERVIEW

This chapter describes how to install the SSIO-24. It details how to select a source of power and the ports to be used. Figure 2-1 shows the location of the Port Direction Switch, in addition to the Terminal Block used to select the power source.

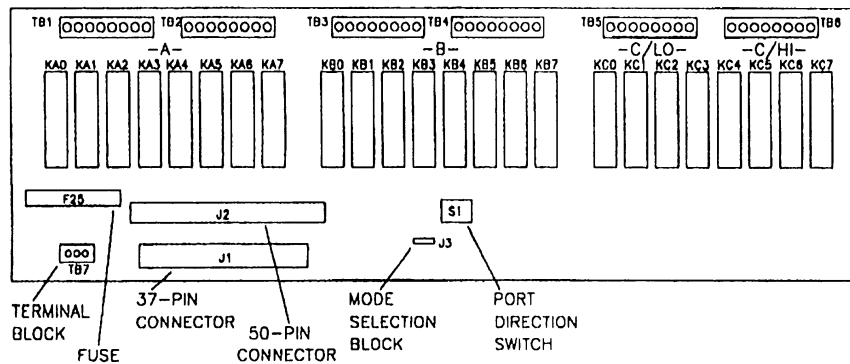

Figure 2-1. Component locations

2.2 TERMINAL BLOCK TB7

The SSIO-24 draws power from the PC, from an external source, or from a combination of the two. Factory configuration sets the Board for power from the PC. To configure the power setting, use one of the following procedures.

Setting For PC Power

NOTE: Do not use the PC power setting if the control signals come from a KPCMCIA-PIO24 module.

On Terminal Block TB7, connect a jumper wire between the terminals marked PC and + (the default setting). This setting is shown in Figure 2-2.

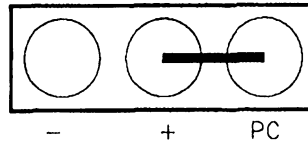

Figure 2-2. The TB7 setting for power from the PC

Setting For External Power Supply

- Control signals come from a standard digital I/O board.

First, remove any jumper wire from TB7. Then, observing polarity, connect the external power supply to the terminals marked + and -, as shown in Figure 2-3. Note that failure to observe polarity will blow Fuse F25.

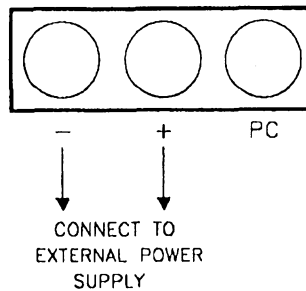

Figure 2-3. Connecting TB7 for external power when control signals come from a standard digital I/O board.

- Control signals come from a KPCMCI A-PIO24 module.

The KPCMCI A-PIO24 does not supply +5V to the SSIO-24. Therefore, you must supply all +5V signals externally, including the +5V that a PC would otherwise supply to the PC terminal on TB7.

On Terminal Block TB7, connect a jumper wire between the terminals marked PC and + (the default setting). See Figure 2-4.

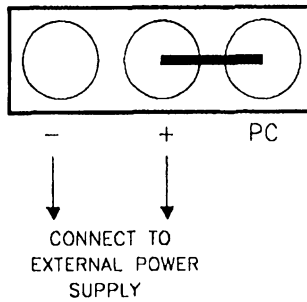

Figure 2-4. Connecting TB7 for external power when the control signals come from a KPCMCIA-PIO24 module.

Then observing polarity, connect the external power supply to the terminals marked + and -, as shown in Figure 2-4. Note that failure to observe polarity will blow Fuse F25 and may damage the board.

2.3 PORT DIRECTION SWITCH S1

Parallel I/O cards PIO-12, PIO-24, PIO-96, uPIO-12, and uPIO-24 use an 8255 PPI type interface for communications (information on the 8255 PPI is available from Intel). The 8255 PPI is configured as three ports: two 8-bit ports (Ports A and B) and one 8-bit port usable as two 4-bit ports (Port C HI/LOW). Each of these 8255 PPI ports corresponds to a port on the SSIO-24. Port Direction Switch S1 (see Figure 2-1) selects the direction of each of these ports.

To set the direction for a port, move the corresponding slide of the Port Direction Switch to the ON or OFF position. For example, inserting OUTPUT modules in Ports A and C/LO and INPUT modules in Ports B and C/HI will require the Port Direction Switch to be set as shown in Figure 2-5.

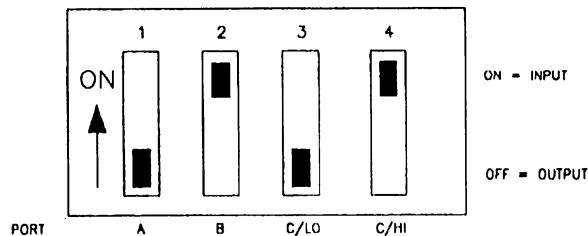

Figure 2-5. Setting the Port Direction Switch

2.4 MODE SELECTION BLOCK J3

The SSIO-24 uses a “power-up” circuit to ensure that output modules will power up in the OFF state when the PC is turned on. This circuit operates in either the Normal Mode or the Protected Mode, depending on the setting of Mode Selection Block J3. The two operating modes are discussed in the subsections that follow.

Normal Mode

J3 = NORM is the factory setting for the Mode Selection Block. Powering up the PC resets the PIO-XX board, making all outputs of the PIO-XX board go active HIGH. At the time a PIO-XX port is programmed for output, all the lines of that port go inactive LOW. The SSIO-24 monitors this transition from a logic HIGH level to a logic LOW level at the first bit of each of the four (4) ports. As soon as the SSIO-24 detects this transition at a port, it enables the OUTPUT modules connected to that port. INPUT modules are always enabled (SW1 setting = INPUT). The SSIO-24 must detect this HIGH to LOW transition for the OUTPUT modules to become enabled.

Two anomalies exist with NORMAL mode because a reset line to the SSIO-24 is unavailable. The anomalies are obvious only when using OUTPUT modules.

After a PIO port is programmed for OUTPUT and the reset button of the PC is pushed, ALL OUTPUT MODULES GO ACTIVE. This activation is a potential problem for applications sensitive to such an event. Either use a *warm reset* (by simultaneously pressing [Ctrl] + [Alt] + [Delete] on the PC) or a *cold reset* (turn off the PC, then restart it). A third alternative is explained under *Protected Mode*, below.

When powering down the PC after the OUTPUT modules are enabled, the OUTPUT modules become ACTIVE for several milliseconds before being shut down by the absence of power. This event can be annoying or potentially dangerous, based on the application. If this behavior is unacceptable, refer to the *Protected Mode*, below.

Protected Mode

This mode is active when J3 = PROT.

In Protected Mode, the SSIO-24 responds to a PC power-down or reset by keeping the OUTPUT modules deactivated. As with Normal Mode, INPUT modules are not a problem and are not affected by this mode. In order to sense a reset at the PC, one of the 24 lines from a PIO-XX must be sacrificed. This leaves 23 of the 24 module locations for normal use. The module location sacrificed is KC7. THIS MODE REQUIRES PORT C/HI TO BE SET FOR OUTPUT ONLY AND MODULE LOCATION KC7 TO BE UNUSED.

This mode works by sensing the Port C7 line of a PIO-XX board. When this bit is high, the SSIO-24 is RESET. When this bit is low, the RESET to the SSIO-24 is removed (NOTE: you must wait a minimum of 200 ms after removal of the SSIO-24 RESET before enabling the OUTPUT ports). Whenever the PC resets the PIO-XX board, this bit goes high and automatically resets the SSIO-24 at the same time the PIO-XX board is reset. This bit also allows you to quickly shut down the entire SSIO-24 with a single write to this location.

The SSIO-24 has a latch for each of the four (4) ports; the latch disables OUTPUT modules after a reset. After you reset the SSIO-24 by writing a one (1) to location C7 of PORT C, you may remove the RESET by writing a zero (0) to location C7 of PORT C. In order to enable the OUTPUT modules, you must clear each latch associated with an OUTPUT port. You may clear the latches by writing zeros to each OUTPUT port to clear the port and writing ones to the OUTPUT ports followed by writing zeros to the OUTPUT ports to clear the latch with the HIGH-to-LOW transition. All OUTPUT ports will now be enabled (NOTE: you must wait a minimum of 200 ms after removal of the SSIO-24 reset before enabling the OUTPUT ports).

Example in BASIC

This example assumes Port A is set for OUTPUT modules.

1. Reset SSIO-24.

```
OUT(BASEADDRESS+2), &H80           'Write 1 to C7
```

2. Remove Reset.

```
OUT(BASEADDRESS+2), &H00           'Write 0 to C7
```

3. 200 ms minimum delay.

```
FOR I=0 TO 1000                   'Delay Before Enabling  
                                'OUTPUT Ports  
NEXT I
```

(NOTE: The upper value of this loop is machine and language dependent. If the value used doesn't work, use a larger one.)

4. Clear Output Port A.

```
OUT(BASEADDRESS+0), &H0            'Write 0s to Port A
```

5. Set Output Port A.

```
OUT(BASEADDRESS+0), &HFF          'Write 1s to Port A
```

6. Clear Output Port A and enable OUTPUT Modules.

```
OUT(BASEADDRESS+0), &H00          'Write 0s to Port A
```

7. Output modules are now ready to accept user input...

NOTE: After the computer has been powered-up or after the RESET button of the computer has been pressed AND the PIO-XX has been set for the appropriate port directions, the user must initiate steps 5 and 6 of the above example BEFORE writing to OUTPUT modules of the SSIO-24.

2.5 INSTALLATION

The SSIO-24 mounts on a flat panel or other flat surface, or it installs in an external rack-type enclosure (such as the Keithley RMF-06 or RTT-02). Rack-type enclosures require an adapter such as the Keithley RMT-02. If the SSIO-24 is to be externally mounted, follow steps 1 through 5 as outlined below. Then, install the SSIO-24 into the rack (or on a flat surface) and proceed with the remaining steps.

1. Install a Parallel I/O board (refer to its user guide for installation instructions). Be sure to assign it a Base Address.
2. Configure Terminal Block TB7 for the appropriate source of power (see Section 2.2).
3. Set the Port Direction Switch (see Section 2.3).
4. Plug your selection of input/output modules into locations KA0-KA7, KB0-KB7, and/or KC0-KC7.
5. Make external connections to the appropriate I/O terminal blocks (TB1 and TB2 for Port A, TB3 and TB4 for Port B, TB5 for Port C/LO and TB6 for Port C/HI).

WARNING

If using DC modules, observe the polarity markings at each terminal location.

6. Install the Hold-Down Bracket.
7. Plug the Parallel I/O card into your computer and connect it to the SSIO-24 with the appropriate cable. For the PIO-12, PIO-24, uPIO-12, or uPIO-24 plug the C-18xx cable into SSIO-24 Connector J1. For the PIO-96, plug the CACC-2000 cable into SSIO-24 Connector J2.

You are now ready to program the Parallel I/O card's ports to correspond with those on the SSIO-24. Be very careful to observe the direction of the ports on the SSIO-24 (refer to the Port Direction Switch). For example, if Port A on the SSIO-24 is set for INPUT, then Port A on the Parallel I/O card must be set for INPUT.

WARNING

Setting corresponding ports on the Parallel I/O Card and the SSIO-24 for opposing directions (Port A on the Parallel I/O Card for input and Port A on the SSIO-24 for output) could result in permanent damage to the Parallel I/O card and the SSIO-24.

2.6 CONNECTOR PIN ASSIGNMENTS

All digital I/O is through a standard 37-pin D-type male connector or through a 50-pin PIO-96 type connector. The connector pin assignments are shown in Figures 2-6 and 2-7.

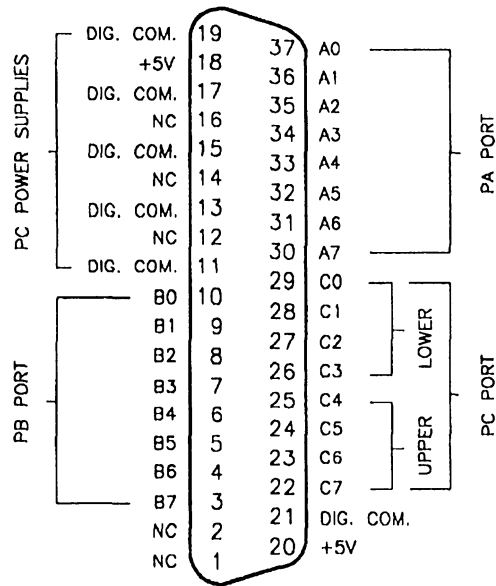

Figure 2-6. 37-pin connector assignments

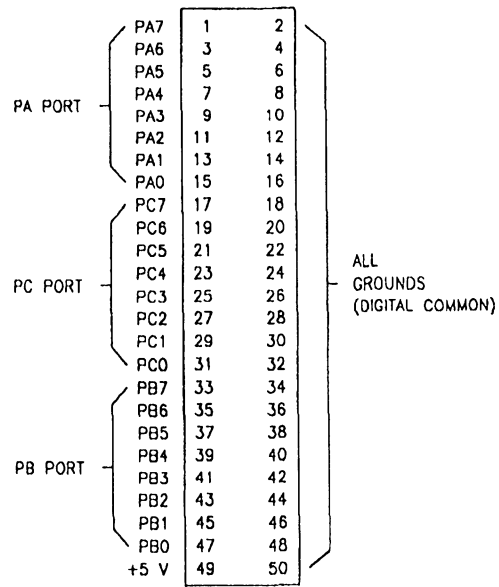

Figure 2-7. 50-pin connector assignments



PROGRAMMING

3.1 OVERVIEW

The Parallel I/O board uses an 8255 PPI type interface for parallel communications (a complete description of this device is available from Intel). The 8255 PPI is divided into two 8-bit ports (Ports A and B) and one 8-bit port that is usable as two 4-bit ports (Port C HI/LO). Each port of the 8255 PPI corresponds to a port on the SSIO-24.

The 8255 PPI has three modes of operation (Mode 1, Mode 2, and Mode 3). When using a Parallel I/O board with the SSIO-24, use the 8255 PPI in Mode 0 only. The port direction and mode are set by writing to the 8255 control register (Parallel I/O board Base Address +3).

3.2 EXAMPLES

In C

This example in C assumes that Ports A and C/LO (KA0-KA7 and KC0-KC3) are for output while Ports B and C/HI are for input.

1. Write to the control register to set Ports A and C/LO to output and Ports B and C/HI to input. For example,

```
outp(Base_address+3, 0x8A);
```

2. Access the ports as needed. For example, to write to Port A,

```
outp(Base_address+0, port_a_data);
```

3. To write to Port C/LO,

```
outp(Base_address+2, port_c_lo_data);
```

4. To read Port B,

```
port_b=inp(Base_address+1);
```

5. To read Port C/HI,

```
port_c_hi=inp(Base_address+2)>>4;
```

In BASIC

This example in BASIC performs the same functions as the example in C. Again, assume Ports A and C/LO (KA0-KA7 and KC0-KC3) are for output while Ports B and C/HI are for input.

1. Write to the control register to set Ports A and C/LO to output and Ports B and C/HI to input. For example,

```
OUT (BASEADDRESS+3) , &H8A
```

2. Access the ports as needed. For example, to write to Port A,

```
OUT (BASEADDRESS+0) , PORTADATA
```

3. To write to Port C/LO,

```
OUT (BASEADDRESS+2) , PORTCLODATA
```

4. To read Port B,

```
PORTB%=INP (BASEADDRESS+1)
```

5. To read Port C/HI,

```
PORTCHI%=INP (BASEADDRESS+2)\16
```

* THE '\16' PERFORMS A SHIFT RIGHT BY 4 POSITIONS

■ ■ ■

FACTORY RETURNS

4.1 FUSE REPLACEMENT

Fuse F25, located as shown in Figure 2-1, will blow if the polarity of external power supply connections does not match that of TB7. A replacement fuse may be any standard 3AG, 250 V, 1 A, fast-blow fuse.

4.2 RETURN REQUIREMENTS

Before returning any equipment for repair, please call 508/880-3000 to notify MetraByte's technical service personnel. If possible, a technical representative will diagnose and resolve your problem by telephone. If a resolution of your problem by telephone is not possible, the technical representative will issue you a Return Material Authorization (RMA) number and ask you to return the equipment. Please reference the RMA number in any documentation regarding the equipment and on the outside of the shipping container.

Note that if you are submitting your equipment for repair under warranty, you must furnish the invoice number and date of purchase.

When returning equipment for repair, please include the following information:

1. Your name, address, and telephone number.
2. The invoice number and date of equipment purchase.
3. A description of the problem or its symptoms.
4. Be sure to reference the RMA number on the outside of the package!

Repackage the equipment. Handle it with ground protection; use anti-static wrapping, if possible.

Ship the equipment to:

Attn: RMA # _____
Repair Department
Keithley Instruments, Inc.
28775 Aurora Road
Cleveland, OH 44139

Telephone 1-888-KEITHLEY
FAX (440) 248-6168



Specifications are subject to change without notice.

All Keithley trademarks and trade names are the property of Keithley Instruments, Inc. All other trademarks and trade names are the property of their respective companies.



Keithley Instruments, Inc. 28775 Aurora Road • Cleveland, Ohio 44139
440-248-0400 • Fax: 440-248-6168
1-888-KEITHLEY (534-8453) www.keithley.com

© Copyright 2000 Keithley Instruments, Inc.
Printed in the U.S.A.

No. 2193
4/2001



Artisan Technology Group is your source for quality new and certified-used/pre-owned equipment

- FAST SHIPPING AND DELIVERY
- TENS OF THOUSANDS OF IN-STOCK ITEMS
- EQUIPMENT DEMOS
- HUNDREDS OF MANUFACTURERS SUPPORTED
- LEASING/MONTHLY RENTALS
- ITAR CERTIFIED SECURE ASSET SOLUTIONS

SERVICE CENTER REPAIRS

Experienced engineers and technicians on staff at our full-service, in-house repair center

*InstraView*SM REMOTE INSPECTION

Remotely inspect equipment before purchasing with our interactive website at www.instraview.com ↗

WE BUY USED EQUIPMENT

Sell your excess, underutilized, and idle used equipment. We also offer credit for buy-backs and trade-ins. www.artisanng.com/WeBuyEquipment ↗

LOOKING FOR MORE INFORMATION?

Visit us on the web at www.artisanng.com ↗ for more information on price quotations, drivers, technical specifications, manuals, and documentation

Contact us: (888) 88-SOURCE | sales@artisanng.com | www.artisanng.com