



## Artisan Technology Group is your source for quality new and certified-used/pre-owned equipment

- FAST SHIPPING AND DELIVERY
- TENS OF THOUSANDS OF IN-STOCK ITEMS
- EQUIPMENT DEMOS
- HUNDREDS OF MANUFACTURERS SUPPORTED
- LEASING/MONTHLY RENTALS
- ITAR CERTIFIED SECURE ASSET SOLUTIONS

### SERVICE CENTER REPAIRS

Experienced engineers and technicians on staff at our full-service, in-house repair center

### *InstraView*<sup>SM</sup> REMOTE INSPECTION

Remotely inspect equipment before purchasing with our interactive website at [www.instraview.com](http://www.instraview.com) ↗

### WE BUY USED EQUIPMENT

Sell your excess, underutilized, and idle used equipment. We also offer credit for buy-backs and trade-ins. [www.artisanng.com/WeBuyEquipment](http://www.artisanng.com/WeBuyEquipment) ↗

### LOOKING FOR MORE INFORMATION?

Visit us on the web at [www.artisanng.com](http://www.artisanng.com) ↗ for more information on price quotations, drivers, technical specifications, manuals, and documentation

**Contact us:** (888) 88-SOURCE | [sales@artisanng.com](mailto:sales@artisanng.com) | [www.artisanng.com](http://www.artisanng.com)

# QUICK START GUIDE

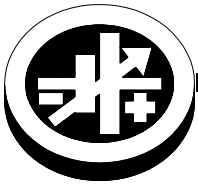

**KEPCO** An ISO 9001 Company.

## RA 19-(X)B

### Rack Adapter



**RA 19-6B, RA 19-7B, RA 19-8B  
RACK ADAPTER**

## I — INTRODUCTION

**SCOPE OF MANUAL.** This Quick Start Guide covers installation and operation of Kepeco RA 19-(X)B Rack Adapters (i.e., RA19-6B, RA 19-7B and RA 19-8B) for two common configurations: independent operation and parallel operation. For the full capabilities and specifications of the RA 19-(X)B, and to take advantage of the many choices and features not covered in this Quick Start Guide, the user is urged to download the complete Operator's Manual from the Kepeco web site at [www.kepecopower.com/support/opman1s.htm#ra19-xb](http://www.kepecopower.com/support/opman1s.htm#ra19-xb)

**DESCRIPTION.** Kepeco RA 19-(X)B rack adapters (Figure 1) are specifically designed for any combination of Kepeco's 3U 50W, 100W or 150W HSF and HSF-PFC power supplies. RA 19-6B holds up to six 150W HSF 3U power supplies; RA 19-7B holds up to four 50W or 100W (slots 1 through 4) and up to three 150W HSF power supplies (slots 5, 6 and 7); RA 19-8B holds up to eight 50W or

100W HSF power supplies. Optional cover plates are available to cover unoccupied slots

These rack adapters are user-configurable for parallel, series, or independent power supply operation. Forced current sharing and OR'ing diodes for N+1 redundancy are built into the HSF power supplies. A-C inputs are split to deliver independent source power to left and right power supply groups. User-configurable keying can ensure that only the correct power supply can be installed in a keyed slot. Input/output connections between RA 19-(X)B and HSF power supply are via HSF connectors that plug into corresponding connectors of the RA 19-(X)B. All connections are made at the rear panel (see Figure 2).

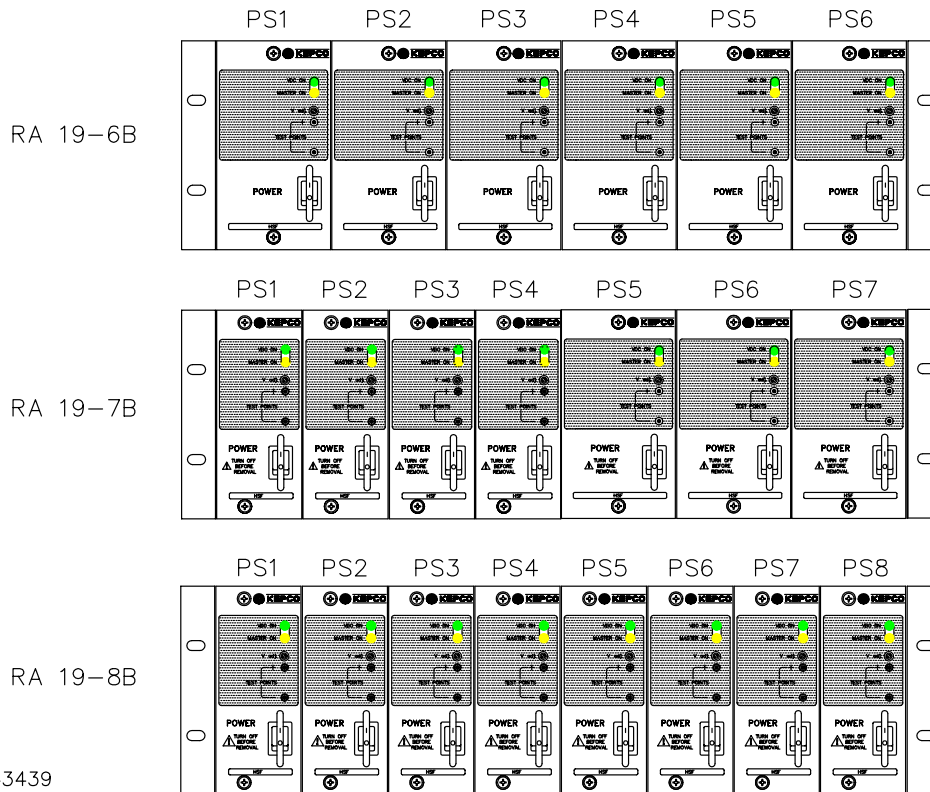

**FIGURE 1. RA 19-(X) B RACK ADAPTERS, FULLY POPULATED**

KEPCO, INC. • 131-38 SANFORD AVENUE • FLUSHING, NY. 11355 U.S.A. • TEL (718) 461-7000 • FAX (718) 767-1102  
<http://www.kepecopower.com> • email: [hq@kepecopower.com](mailto:hq@kepecopower.com)

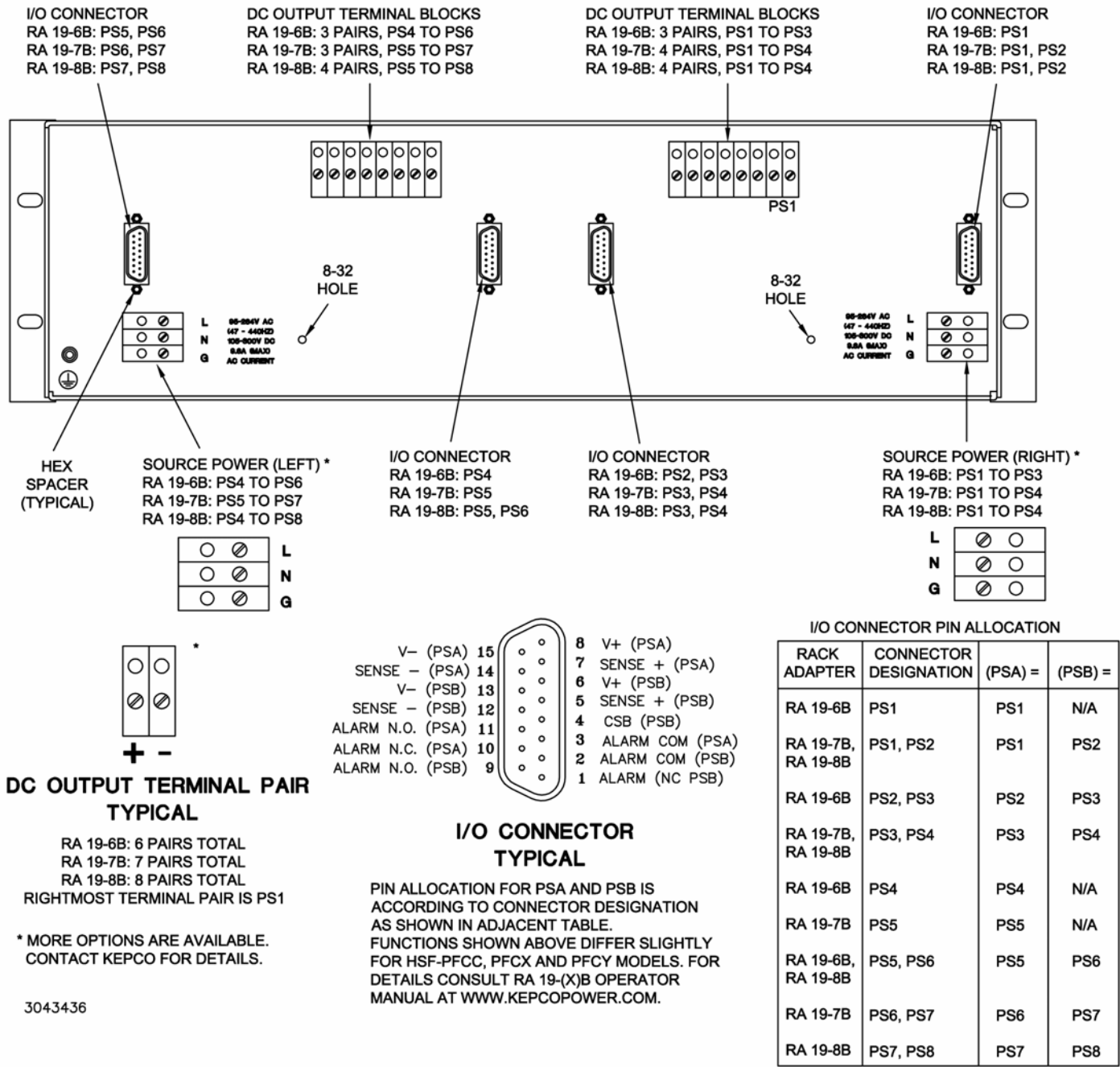

FIGURE 2. REAR PANEL CONNECTIONS, TYPICAL

## II — PRE-INSTALLATION.

**NOTE:** Either local or remote sensing **MUST** be used. For independent operation configure the DIP switches. For parallel operation use external wires

**DIP SWITCHES.** Each slot has one DIP switch (see Figure 3): DIP 1 is for PS1 sense lines; DIP 2 is for PS2 sense lines and for paralleling PS1 and PS2. The rest of the DIP switches are similar to DIP 2, each configuring the sense lines for that slot and for paralleling the adjacent (lower number) slot. Table 1 describes the function of each DIP switch position. See below to access the DIP switches.

**ACCESSING DIP SWITCHES.** The DIP switches (Figure 3) are accessible either a) from the front without disassembly by using a long flat-tip screwdriver after removing all power supplies from the rack, or b) by separating the rear panel from the chassis as described below:

1. Remove all power supplies from the rack adapter.
2. Remove eight hex spacers securing the four I/O connectors to the rear panel.
3. Remove four screws (two at the top and two at the bottom) securing the rear panel to the chassis and separate

the rear panel from the chassis. It is not necessary to remove the ground connection (if present) between the rear panel and the chassis.

4. Remove seven screws (three at the top and four at the bottom) securing the back plate to the chassis and remove the rear panel to gain access to the interior components.

**OPTIONAL KEYING:** HSF power supplies are keyed by voltage at the factory. A keyway can be established at the rack adapter by installing a key pin (supplied) into the corresponding hole as indicated in Figure 3 so that the pins match the open holes of the power supply. Secure with mounting nut at the rear panel using two 1/4-inch nutdrivers or deep sockets. **DO NOT ALTER THE KEYING ON THE POWER SUPPLY.**

**INDEPENDENT OPERATION.** The RA 19-(X)B rack adapter is shipped with the DIP switches of all slots configured for independent operation (see Figure 3) and local sensing. Refer to RA 19-(X)B manual for remote sensing.

**TABLE 1. REAR PANEL (INTERIOR) DIP SWITCH FUNCTIONS**

DIP SWITCH POSITION	FUNCTION	DIP SWITCH SETTINGS
1, 2	Local / Remote Sensing Selection	Position 1 connects +V+ to +S, Position 2 connects -V to -S. Both required ON (factory default) for independent operation with Local Sensing. Both required OFF for: a) Independent configurations using Remote Sensing. b) Independent configurations using Local Sensing with user supplied connections from +V+ to +S and -V to -S. c) All parallel configurations (sensing must be established using external wires). d) All series connections.
3, 4 (SEE NOTE)	Connect Sense + and - in parallel	Position 3 connects +S to adjacent slot +S, Position 4 connects -S to adjacent slot -S. Both required OFF (factory default) for all configurations except parallel configurations using DIP switch settings to connect the sense leads in parallel. Both required ON for parallel configurations using DIP switch settings to connect the sense leads in parallel.
5	Current Balance (forced current share)	Required ON for parallel operation with forced current share (connects current share lines in parallel) unless connections are made via external wires Required OFF (factory default) for a) independent and series configurations. b) Parallel configurations using external wires at I/O connector to connect CSB (current share bus) lines in parallel. c) Parallel configurations without forced current sharing (current balancing),
6, 7	Close on Failure Alarm	When set to OFF (factory default), individual power supplies produce closure between I/O connector N.O. and COM pins upon failure. When set to ON, parallels N.O pins of adjacent slots to allow a single alarm to provide failure indication (contact closure between N.O. pin and COM pin) if any one of many power supplies fails.
8	Open on Failure Alarm	When set to OFF (factory default), individual power supplies produce open between I/O connector N.C. and COM pins upon failure. When set to ON, connects N.C to COM between adjacent slots so that individual alarms are connected in series. This allows a single alarm to provide failure indication (contact open between N.C. pin and COM pin) if any one of many power supplies fails.

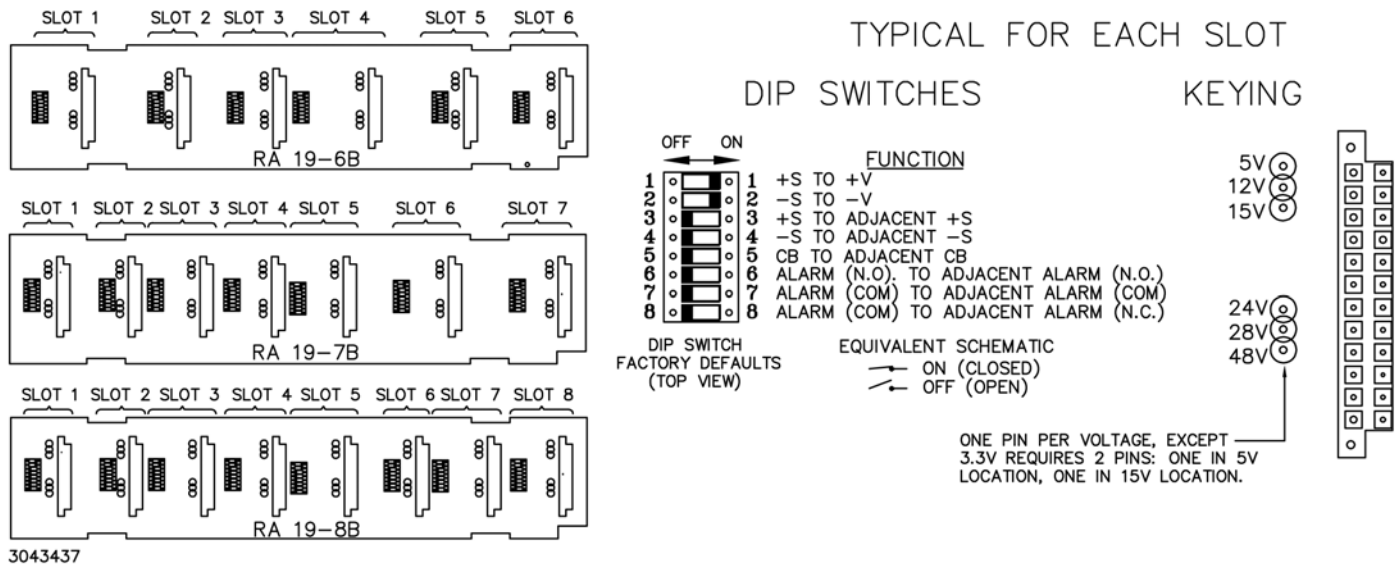

**FIGURE 3. BACKPLATE, INTERIOR VIEW, DIP SWITCHES AND KEYING**

**PARALLEL OPERATION.** The most common use for the RA 19-(X)B rack adapter is with two or more HSF's connected in parallel to a single load with forced current sharing to increase current output, increase reliability and/or provide redundancy. Only adjacent slots can be connected in parallel using DIP switches.

Figure 4 shows HSF's in slots 2 and 3 connected in parallel (master/slave, master established automatically by voltage) with forced current sharing and a close-on-fail alarm circuit. Both HSF modules are configured for output voltage to be adjusted from the front panel trimpot (factory default setting). See HSF operator manual for other output voltage adjustment options.

**Configure DIP 4:**

1. Set positions 1 and 2, to ON. This connects +S to +V and -S to -V for slot 4, establishing local sensing for slot 4 if slot 4 is to be used.
2. Set positions 3 and 4, to OFF. This isolates sense lines ( $\pm S$ ) between slots 4 and 3.
3. Set position 5 to OFF. This isolates the current share bus (CB) between slots 4 and 3.

4. Set position 6 and 7, to OFF. This isolates the ALARM (N.O.) and ALARM (COM) lines between slots 4 and 3.
5. Set position 8 to OFF. This position is only set to ON for open-on-fail alarm circuits.

**Configure DIP 3:**

6. Set positions 1 and 2, to ON. This connects +S to +V and -S to -V for slot 3, establishing local sensing for slot 3.
7. Set positions 3 and 4, to ON. This connects sense lines (+S to +S and -S to -S) for slots 3 and 2.
8. Set position 5, to ON. This connects the current share bus (CB) for slots 3 and 2.
9. Set positions 6 and 7 to ON. Position 6 connects the normally open ALARM (N.O.) lines and position 7 connects the ALARM (COM) (common) for slots 3 and 2, implementing a close-on-fail alarm circuit (see equivalent schematic shown in Figure 4. If either PS2 or PS3 fails, a contact closure provides continuity across pins 7 and 14 of both I/O 4 and I/O 3.
10. Set position 8 to OFF. This position is only set to ON for open-on-fail alarm circuits.

## Configure DIP 2:

- Set positions 1 and 2, to ON. This connects +S to +V and -S to -V for slot 2, establishing local sensing for slot 2.
- Set positions 3 and 4, to OFF. This isolates sense lines ( $\pm S$ ) between slots 2 and 1.
- Set position 5 to OFF. This isolates the current share bus (CB) between slots 2 and 1.
- Set position 6 and 7, to OFF. This isolates the ALARM (N.O.) and ALARM (COM) lines between slots 2 and 1.

5. Set position 8 to OFF. This position is only set to ON for open-on-fail alarm circuits.

**SERIES OPERATION.** See RA 19-(X)B Operator Manual for series operation details.

**ALARMS.** For independent configurations, Close on Fail contact closure is across I/O connector pins for ALARM N.O. and ALARM COM (see Figure 4). Open on Fail circuits are across I/O connector pins for ALARM N.C. and ALARM COM. Figure 4 shows a parallel close-on-fail circuit for slots 2 and 3 using the DIP switches to make the connections. See Operator Manual for other options.

### NOTES:

- SLOTS 2 AND 3 CONFIGURED FOR AUTOMATIC MASTER/SLAVE PARALLEL OPERATION, LOCAL SENSING (USING DIP SWITCHES); PARALLELING OF SENSE CONNECTIONS, CURRENT SHARE AND CLOSE ON FAIL ALARM IMPLEMENTED USING DIP SWITCHES.
- HSF/HSF-PFC POWER SUPPLIES MUST BE CONFIGURED FOR FRONT PANEL CONTROL OF OUTPUT VOLTAGE.
- USE I/O MATING CONNECTORS (SUPPLIED) FOR ALARM CONNECTIONS.

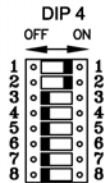

DIP 4 FUNCTIONS

- +S4 TO +V4 (LOCAL SENSE) (SEE NOTE 2.)
- S4 TO -V4 (LOCAL SENSE) (SEE NOTE 2.)
- ISOLATE +S4 FROM +S3 (SEE NOTE 2.)
- ISOLATE -S4 FROM -S3 (SEE NOTE 2.)
- ISOLATE CB4 FROM CB3
- ISOLATE ALARM (N.O.4) FROM ALARM (N.O.3)
- ISOLATE ALARM (COM4) FROM ALARM (COM3)
- ISOLATE ALARM (COM4) FROM ALARM (N.C.3)

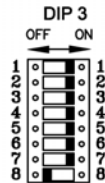

DIP 3 FUNCTIONS

- +S3 TO +V3 (LOCAL SENSE) (SEE NOTE 2.)
- S3 TO -V3 (LOCAL SENSE) (SEE NOTE 2.)
- CONNECT +S3 TO +S2 (SEE NOTE 2.)
- CONNECT -S3 TO -S2 (SEE NOTE 2.)
- CONNECT CB3 TO CB2
- CONNECT ALARM (N.O.3) TO ALARM (N.O.2)
- CONNECT ALARM (COM3) FROM ALARM (COM2)
- ISOLATE ALARM (COM3) FROM ALARM (N.C.2)



DIP 2 FUNCTIONS

- +S2 TO +V2 (LOCAL SENSE) (SEE NOTE 2.)
- S2 TO -V2 (LOCAL SENSE) (SEE NOTE 2.)
- ISOLATE +S2 FROM +S1 (SEE NOTE 2.)
- ISOLATE -S2 FROM -S1 (SEE NOTE 2.)
- ISOLATE CB2 FROM CB1
- ISOLATE ALARM (N.O.2) FROM ALARM (N.O.1)
- ISOLATE ALARM (COM2) FROM ALARM (COM1)
- ISOLATE ALARM (COM2) FROM ALARM (N.C.1)

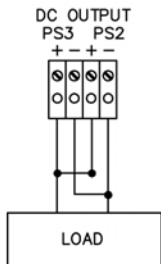

3043438

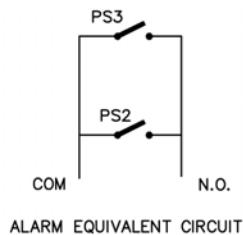

### FOR RA 19-6B

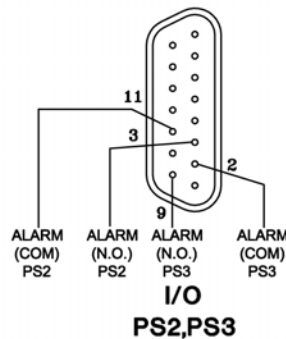

### FOR RA 19-7B AND RA 19-8B

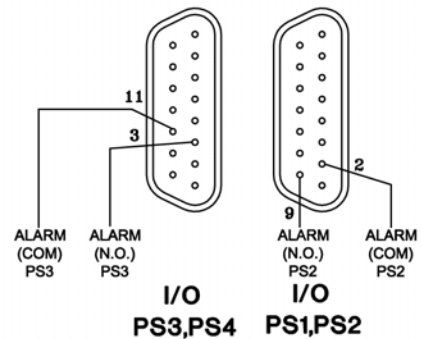

FIGURE 4. SLOTS 2 AND 3 CONFIGURED FOR PARALLEL OPERATION, WITH CLOSE ON FAIL ALARM CIRCUIT

### III — INSTALLATION

**MOUNTING RACK ADAPTER:** The rack adapter mounts directly to EIA-RS 310D standard 19" racks via the two mounting ears; two screws are required per mounting ear for proper support.

**CAUTION:** Rack adapter should be mounted before installing power supplies.

Two 8-32 threaded holes (see Figure 2) are provided adjacent to each input power terminal block which can be used for user-supplied strain relief cable clamps if desired.

### IV — WIRING

**A-C WIRING:** It is the user's responsibility to obey all local, national and international safety rules regarding field-wired apparatus and the grounding of the metal cover and case of any instrument connected to the a-c power source. Grounding is an intrinsic part of the safety aspect of the unit.

**SOURCE POWER:** Source power requirements are determined by the HSF power supply (see HSF power supply Instruction Manual); no adjustment or modification of the rack adapter is required.

Source power can also be custom configured via jumpers on the internal PC board. Contact Kepco Applications Engineering for further details.

Wire must be sized according to expected current. Wire size range for each terminal block is AWG 20-10; torque to 6 lb-in (0.6 N•M) maximum. **CAUTION: PROTECTION OF INPUT WIRING REQUIRES USER-CONFIGURED SAFETY INTERRUPTS.** The terminals are labeled L, N, and G. Their functions are:

- Terminal G (Ground) is the safety ground connection for the RA 19-(X)B.

**INSTALLATION/REMOVAL OF HSF POWER SUPPLIES:** To install each HSF power supply insert HSF power supply in selected slot until power supply front panel is flush with rack adapter chassis. and secure with two front panel screws on power supply.

**CAUTION:** Do not overtighten these screws: max. torque is 2 in.-lbs (0.23 N x m).

**WARNING:** Removal of HSF power supply from a "live" system must be done only by authorized service personnel after HSF power switch is set to OFF. Dangerous voltages may be accessible through the open slot after a power supply is removed.

- Terminals L (Line Phase) and N (Neutral) are connected to the input power entry connectors. Source power is distributed to the power supplies according to the label on the rear panel.

**CONTROL SIGNALS:** Access to all the control signals for each HSF power supply is provided via two 15-pin D-subminiature I/O connectors on the rear panel of the rack adapter (see Figure 2). Four mating connectors (Kepco P/N 142-0449) are provided in a plastic bag.

**OUTPUT LOAD:** Load connections to the rack adapters are achieved via two 4-terminal terminal blocks located on the rear panel assembly. DC OUTPUT + and – for PS1 and PS2 are on one terminal block and + and – for PS3 and PS4 are on the other. Wire must be sized according to expected current. Wire gage may be between 20 GA and 10 GA; torque to 6 lb-in (0.6 N•M) maximum. As the length of load wires increases, ripple and noise may increase proportionally, therefore length and placement are critical for minimum ripple and noise. A filter consisting of a 50mF electrolytic capacitor in parallel with a 0.01mF capacitor must be used to eliminate unwanted ripple and noise pickup on the load wire during measurements. For remote sensing refer to RA 19-(X)B Operator manual. For noise-sensitive applications the load wires and sense wires must be twisted and/or shielded.



## Artisan Technology Group is your source for quality new and certified-used/pre-owned equipment

- FAST SHIPPING AND DELIVERY
- TENS OF THOUSANDS OF IN-STOCK ITEMS
- EQUIPMENT DEMOS
- HUNDREDS OF MANUFACTURERS SUPPORTED
- LEASING/MONTHLY RENTALS
- ITAR CERTIFIED SECURE ASSET SOLUTIONS

### SERVICE CENTER REPAIRS

Experienced engineers and technicians on staff at our full-service, in-house repair center

### *InstraView*<sup>SM</sup> REMOTE INSPECTION

Remotely inspect equipment before purchasing with our interactive website at [www.instraview.com](http://www.instraview.com) ↗

### WE BUY USED EQUIPMENT

Sell your excess, underutilized, and idle used equipment. We also offer credit for buy-backs and trade-ins. [www.artisanng.com/WeBuyEquipment](http://www.artisanng.com/WeBuyEquipment) ↗

### LOOKING FOR MORE INFORMATION?

Visit us on the web at [www.artisanng.com](http://www.artisanng.com) ↗ for more information on price quotations, drivers, technical specifications, manuals, and documentation

**Contact us:** (888) 88-SOURCE | [sales@artisanng.com](mailto:sales@artisanng.com) | [www.artisanng.com](http://www.artisanng.com)