



Artisan Technology Group is your source for quality new and certified-used/pre-owned equipment

- FAST SHIPPING AND DELIVERY
- TENS OF THOUSANDS OF IN-STOCK ITEMS
- EQUIPMENT DEMOS
- HUNDREDS OF MANUFACTURERS SUPPORTED
- LEASING/MONTHLY RENTALS
- ITAR CERTIFIED SECURE ASSET SOLUTIONS

SERVICE CENTER REPAIRS

Experienced engineers and technicians on staff at our full-service, in-house repair center

*InstraView*SM REMOTE INSPECTION

Remotely inspect equipment before purchasing with our interactive website at www.instraview.com ↗

WE BUY USED EQUIPMENT

Sell your excess, underutilized, and idle used equipment. We also offer credit for buy-backs and trade-ins. www.artisanng.com/WeBuyEquipment ↗

LOOKING FOR MORE INFORMATION?

Visit us on the web at www.artisanng.com ↗ for more information on price quotations, drivers, technical specifications, manuals, and documentation

Contact us: (888) 88-SOURCE | sales@artisanng.com | www.artisanng.com

■ Dimensions

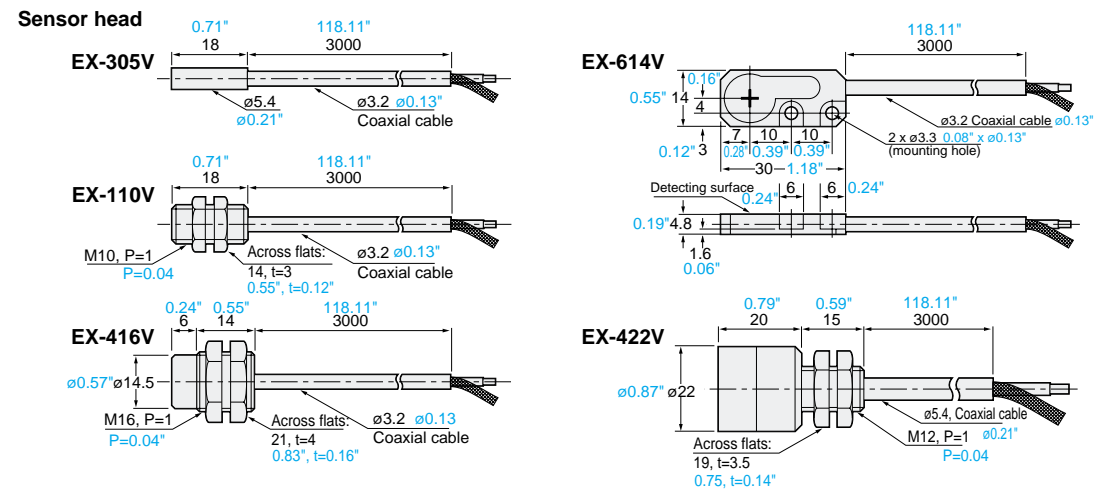
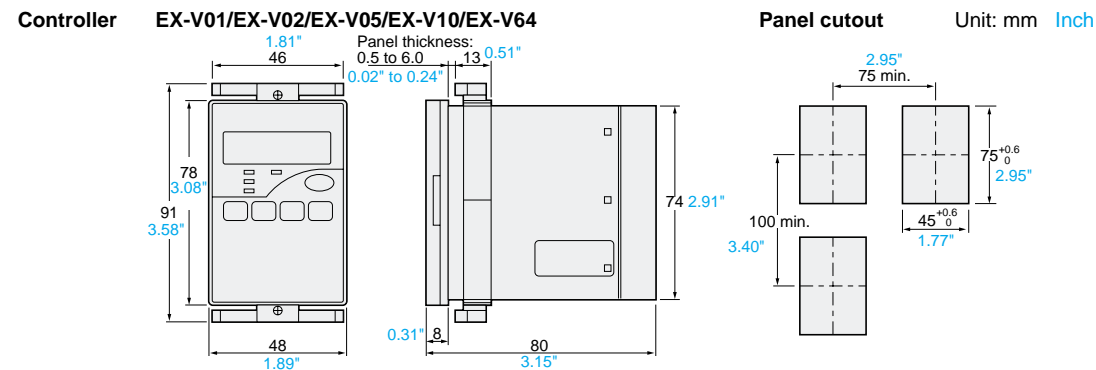

■ Options

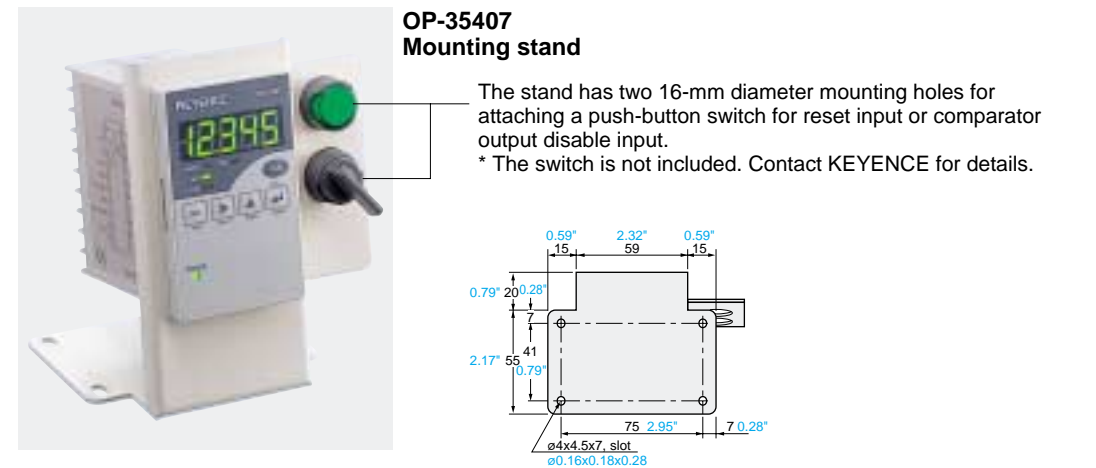

NEW High-speed, High-Accuracy Digital Displacement Inductive Sensor EX-V Series



Visit our website for other Keyence products at www.keyence.com

Specifications are subject to change without notice.



KEYENCE CORPORATION OF AMERICA
Corporate Office
50 Tice Blvd., Woodcliff Lake, NJ 07677, U.S.A.

- | | | | | |
|---|--|---|--|--|
| Boston Office
Phone: 781-453-2244 Fax: 781-453-2255 | Atlanta Office
Phone: 770-951-1222 Fax: 770-951-1958 | Michigan Office
Phone: 734-591-9922 Fax: 734-591-1722 | St. Louis Office
Phone: 314-275-9174 Fax: 314-275-9175 | Portland Office
Phone: 503-699-0500 Fax: 503-699-8400 |
| New Jersey Office
Phone: 201-291-4000 Fax: 201-291-8860 | Tampa Office
Phone: 813-998-9886 Fax: 813-998-9887 | Indianapolis Office
Phone: 317-471-3551 Fax: 317-471-3550 | Texas Office
Phone: 972-733-6790 Fax: 972-733-6791 | Northern California Office
Phone: 925-225-1550 Fax: 925-225-1440 |
| Pennsylvania Office
Phone: 610-768-8993 Fax: 610-337-1067 | Cleveland Office
Phone: 216-464-7530 Fax: 216-464-7540 | Chicago Office
Phone: 847-969-0001 Fax: 847-969-0453 | Denver Office
Phone: 303-756-5242 Fax: 303-756-8301 | Los Angeles Office
Phone: 310-851-8635 Fax: 310-851-8681 |
| Charlotte Office
Phone: 704-423-0070 Fax: 704-423-0066 | Columbus Office
Phone: 614-799-3400 Fax: 614-799-3401 | Minneapolis Office
Phone: 612-449-5163 Fax: 612-449-5169 | Phoenix Office
Phone: 602-225-2400 Fax: 602-225-2425 | |

© KEYENCE CORPORATION, 2000 EXV-KA-C-2-1200 Printed in Japan

High-speed Sub-micron Displacement Sensor with 40,000 Samples/sec.

High Accuracy Inductive Gauging Technology



High-Performance & Simple Setup

High-speed, high-accuracy detection allows for 24-hour monitoring of facilities and products, preventing defective products from being produced.

The high-speed, 40,000 samples/second sampling, does not overlook any instantaneous changes. Even high-speed production lines or moving objects can be measured accurately and efficiently. The EX-V Series significantly improves the reliability of facility monitoring system by adding more accurate measurement to the rugged design, which is virtually unaffected by harsh environments.

Bottom-dead-center measurement

High-accuracy and high-speed sampling enables the detection of minute changes in end of stroke.

Vibration measurement

The high-speed sampling of 40,000 times/second allows for reliable detection of abnormal vibrations in facilities.

Gap measurement

The rugged, compact sensor head allows for accurate measurement of the position or gap between devices.

High-speed, High-Accuracy Digital Displacement Sensor
EX-V Series

Best-in-its class accuracy and high-speed sampling

The EX-V series combines high-speed sampling with a newly developed linearity correction circuit which results in dramatic performance improvement over conventional eddy current systems.

High-speed sampling: 40,000 samples/second

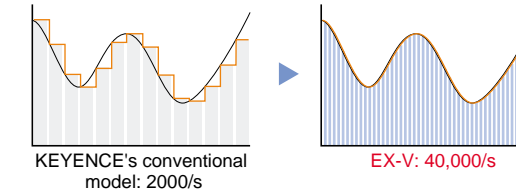

Instantaneous changes can be detected reliably.

The high-speed digital processing circuit allows for accurate detection of real peak (bottom) values that cannot be detected at conventional sampling speeds.

High resolution: 0.02% of F.S.; Linearity: ±0.3% of F.S.

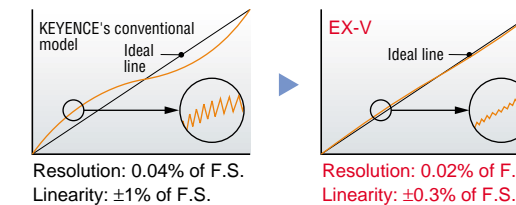

FLL circuit for high accuracy

The FLL (Flat Level Linearize) circuit applies the optimal linearization correction for each individual sensor head. You can achieve the measurement with best-in-its class accuracy with simple setting.

Significant reductions in cost/labor-hours at the touch of a button

The optimal program for the application is automatically set by just selecting the measurement mode. There is no need for complicated settings of a trigger input, timer setting or arithmetic operation using external devices.

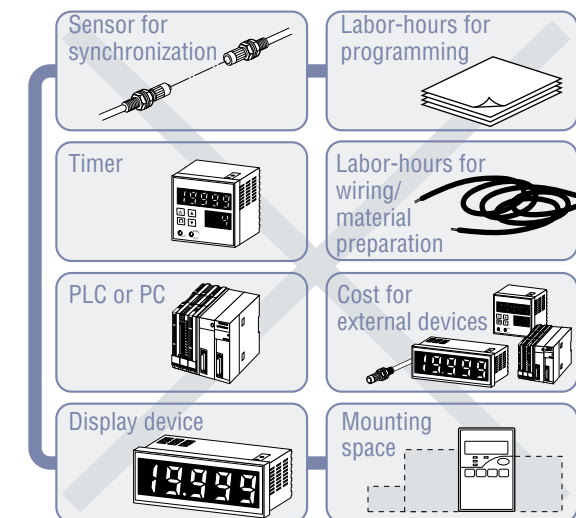

Timer operation or average value calculation can be set at the push of a button on the EX-V digital controller. No PLC or PC is necessary. No external devices are needed for synchronization.

Small and highly resistant sensor head

Considering the use in factories, the sensor head is designed to be resistant against harsh environments, to save space and to allow for easy maintenance.

Resistant against harsh environments: IP-67 rated



All models are rated as IP-67, offering resistance against both water and oil. They offer reliable operation even in harsh environments.

Space saving: Compact or low-profile type available

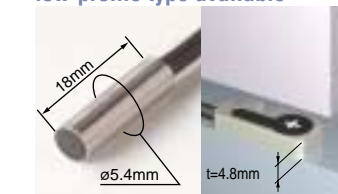

You can select the optimal sensor head according to the application and available mounting space.

Easy maintenance

Compatible sensor head
The FLL circuit allows for compatibility among sensor heads of the same model.

Alarm output
The alarm output indicates accidental breakage or disconnection of the sensor head.

Easy maintenance and useful functions ensure reliable operation in factories.

High-Performance & Simple Setup

High-speed, high-accuracy detection allows for 24-hour monitoring of facilities and products, preventing defective products from being produced.

The high-speed, 40,000 samples/second sampling, does not overlook any instantaneous changes. Even high-speed production lines or moving objects can be measured accurately and efficiently. The EX-V Series significantly improves the reliability of facility monitoring system by adding more accurate measurement to the rugged design, which is virtually unaffected by harsh environments.

Bottom-dead-center measurement

High-accuracy and high-speed sampling enables the detection of minute changes in end of stroke.

Vibration measurement

The high-speed sampling of 40,000 times/second allows for reliable detection of abnormal vibrations in facilities.

Gap measurement

The rugged, compact sensor head allows for accurate measurement of the position or gap between devices.

High-speed, High-Accuracy Digital Displacement Sensor
EX-V Series

Best-in-its class accuracy and high-speed sampling

The EX-V series combines high-speed sampling with a newly developed linearity correction circuit which results in dramatic performance improvement over conventional eddy current systems.

High-speed sampling: 40,000 samples/second

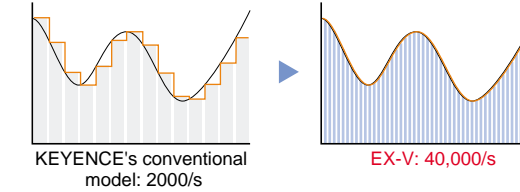

Instantaneous changes can be detected reliably.

The high-speed digital processing circuit allows for accurate detection of real peak (bottom) values that cannot be detected at conventional sampling speeds.

High resolution: 0.02% of F.S.; Linearity: ±0.3% of F.S.

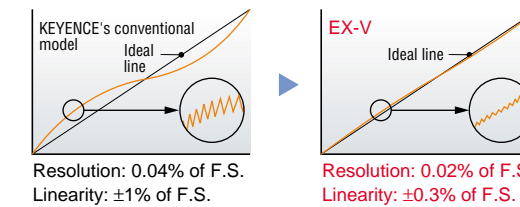

FLL circuit for high accuracy

The FLL (Flat Level Linearize) circuit applies the optimal linearization correction for each individual sensor head. You can achieve the measurement with best-in-its class accuracy with simple setting.

Significant reductions in cost/labor-hours at the touch of a button

The optimal program for the application is automatically set by just selecting the measurement mode. There is no need for complicated settings of a trigger input, timer setting or arithmetic operation using external devices.

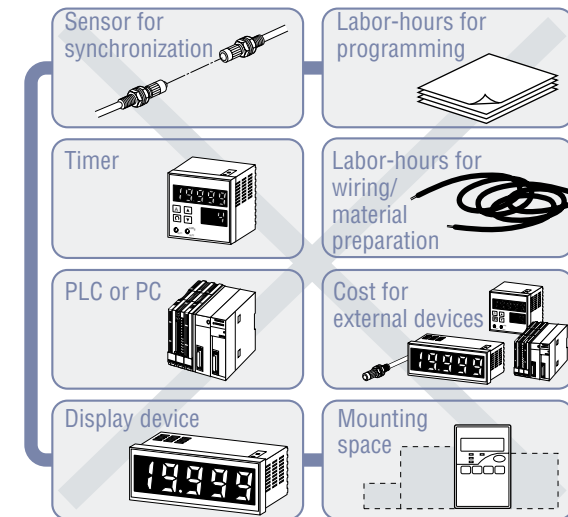

Timer operation or average value calculation can be set at the push of a button on the EX-V digital controller. No PLC or PC is necessary. No external devices are needed for synchronization.

Small and highly resistant sensor head

Considering the use in factories, the sensor head is designed to be resistant against harsh environments, to save space and to allow for easy maintenance.

Resistant against harsh environments: IP-67 rated



All models are rated as IP-67, offering resistance against both water and oil. They offer reliable operation even in harsh environments.

Space saving: Compact or low-profile type available

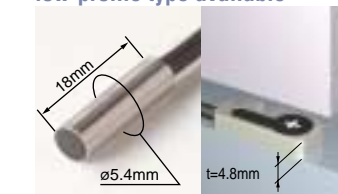

You can select the optimal sensor head according to the application and available mounting space.

Easy maintenance

Compatible sensor head
The FLL circuit allows for compatibility among sensor heads of the same model.

Alarm output
The alarm output indicates accidental breakage or disconnection of the sensor head.

Easy maintenance and useful functions ensure reliable operation in factories.

Just select the optimal setting for your application.

Basic modes for quick operation

Optimal settings for common applications are preprogrammed. Simply selecting the appropriate mode completes the setting. There is no need for time-consuming initial setting or adjustment.

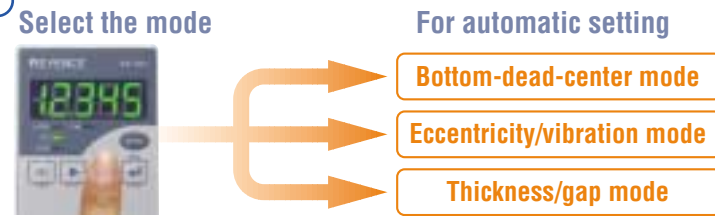

Bottom-dead-center mode

Bottom-dead-center hold Automatic trigger Previous value comparison

Automatically detects the bottom dead center of stroke.

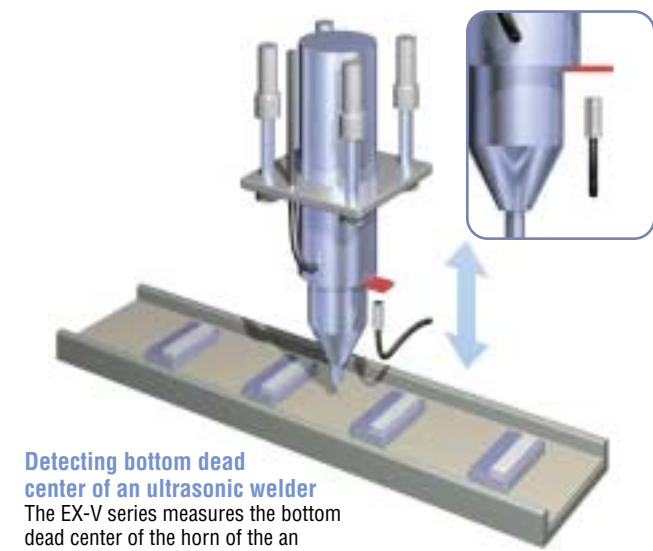

Detecting bottom dead center of an ultrasonic welder
The EX-V series measures the bottom dead center of the horn of the an ultrasonic welder to detect defective welding.

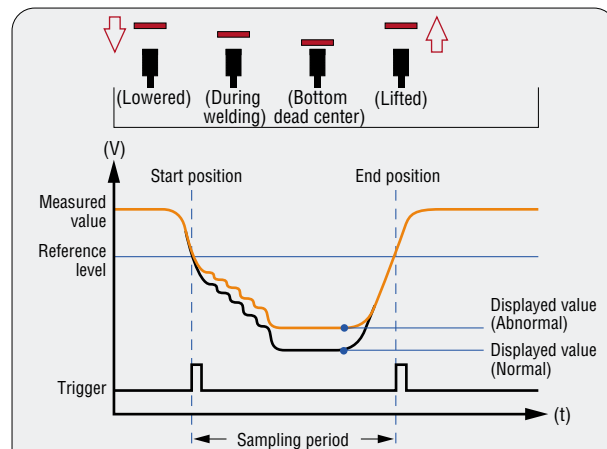

Just selecting the bottom-dead-center mode automatically activates trigger inputs. The position of the bottom dead center within the sampling period is detected and then judged whether it is within the tolerance range or not.

Eccentricity/vibration mode

Amplitude hold Automatic trigger Cyclical difference measurement

Accurately measures amplitude without being affected by changes over time.

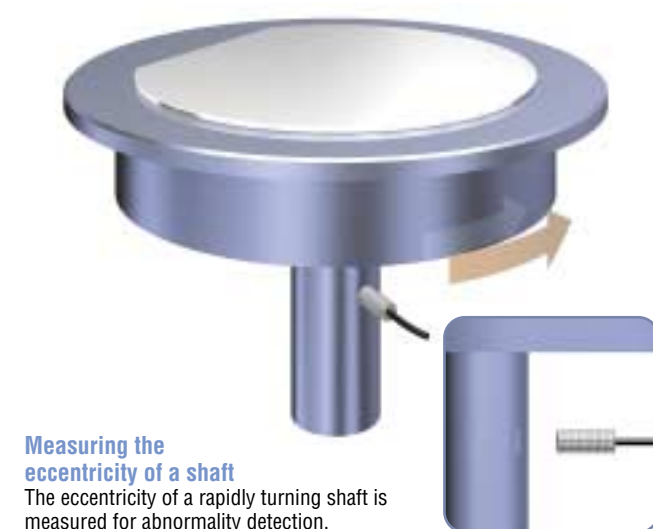

Measuring the eccentricity of a shaft
The eccentricity of a rapidly turning shaft is measured for abnormality detection.

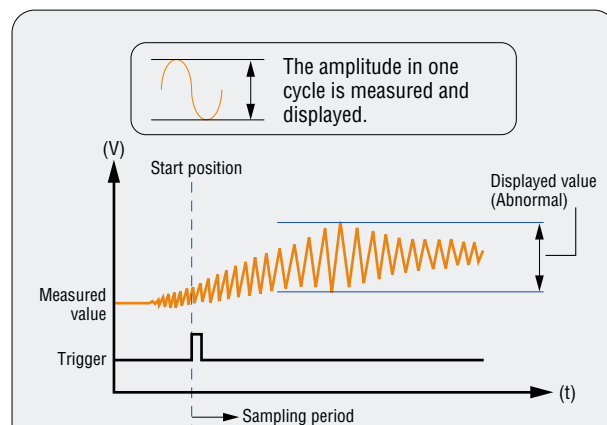

Measurement automatically starts when the amplitude exceeds the specified value. If the amplitude exceeds the tolerance range, an output is produced to indicate abnormal vibration.

Thickness/gap mode

Continuous Average Internal timer

Measures the average thickness of the desired section with a simple setting.

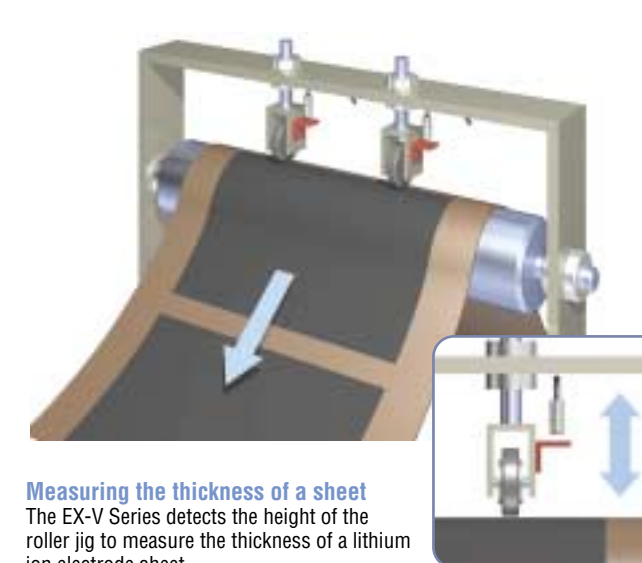

Measuring the thickness of a sheet
The EX-V Series detects the height of the roller jig to measure the thickness of a lithium ion electrode sheet.

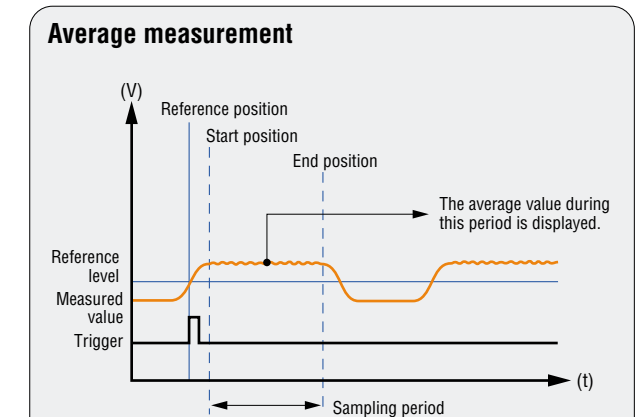

Just selecting the "Average" measurement type automatically activates trigger inputs to measure the average value within the specified section.

Select the program best suited for your application.

Various measurement modes

You can select the measurement mode best suited for your application, such as the limited bottom-dead-center mode or difference between peaks (bottoms) mode.

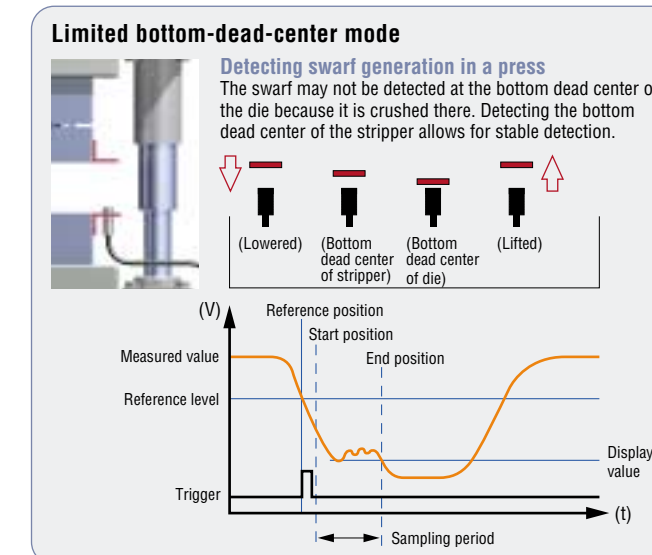

Automatic trigger

When a target approaches the sensor, a trigger signal is automatically turned ON to start measurement. There is no need for an external trigger input or timer setting.

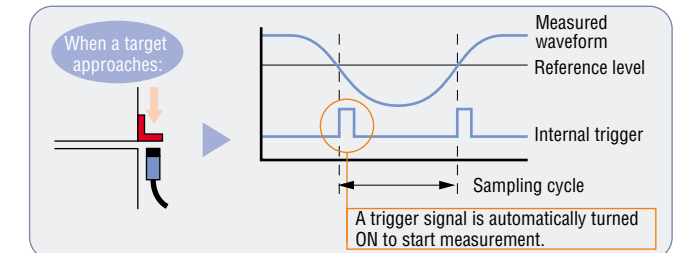

Timer function

The flicker function using the internal timer allows for measurement of the average value or vibration within a specified period. Moreover, the timer enables adjustment of the start or end point of measurement from the instant the automatic trigger is turned ON.

Previous value comparison

The latest measured value can be compared with the average value of the previous measurements. This allows for the detection of only abrupt changes without being affected by changes over time.

Just select the optimal setting for your application.

Basic modes for quick operation

Optimal settings for common applications are preprogrammed. Simply selecting the appropriate mode completes the setting. There is no need for time-consuming initial setting or adjustment.

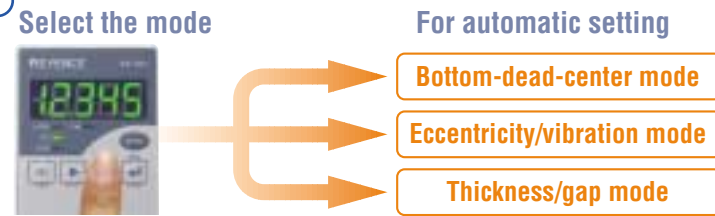

Bottom-dead-center mode

Bottom-dead-center hold Automatic trigger Previous value comparison

Automatically detects the bottom dead center of stroke.

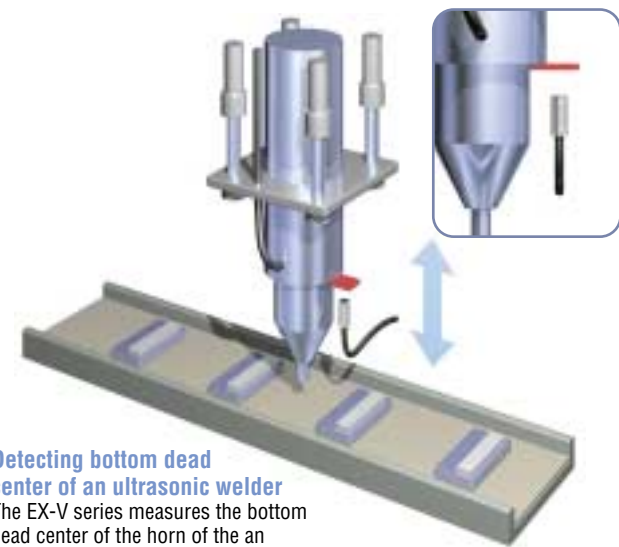

Detecting bottom dead center of an ultrasonic welder
The EX-V series measures the bottom dead center of the horn of the an ultrasonic welder to detect defective welding.

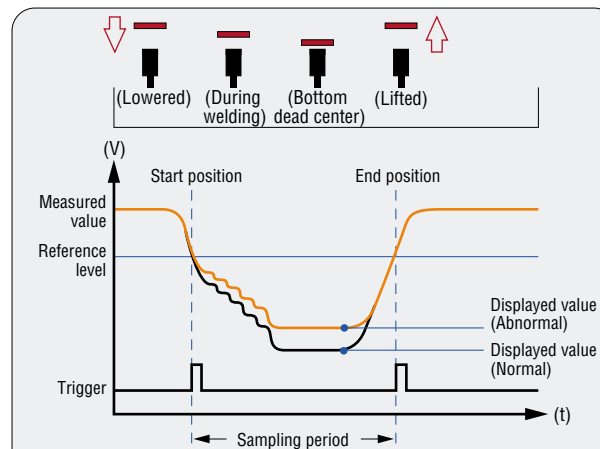

Just selecting the bottom-dead-center mode automatically activates trigger inputs. The position of the bottom dead center within the sampling period is detected and then judged whether it is within the tolerance range or not.

Eccentricity/vibration mode

Amplitude hold Automatic trigger Cyclical difference measurement

Accurately measures amplitude without being affected by changes over time.

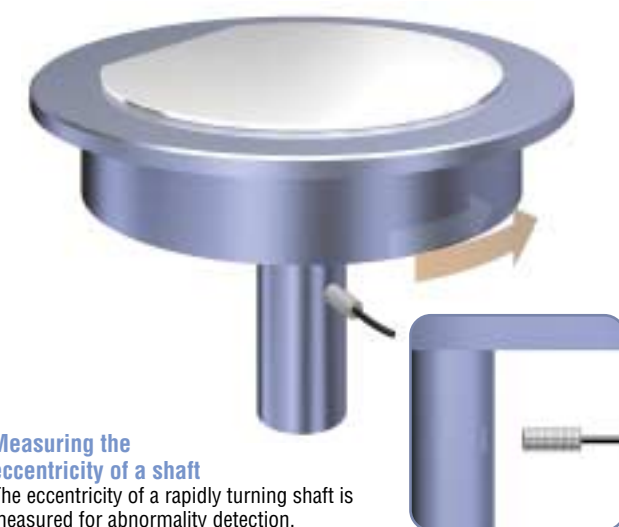

Measuring the eccentricity of a shaft
The eccentricity of a rapidly turning shaft is measured for abnormality detection.

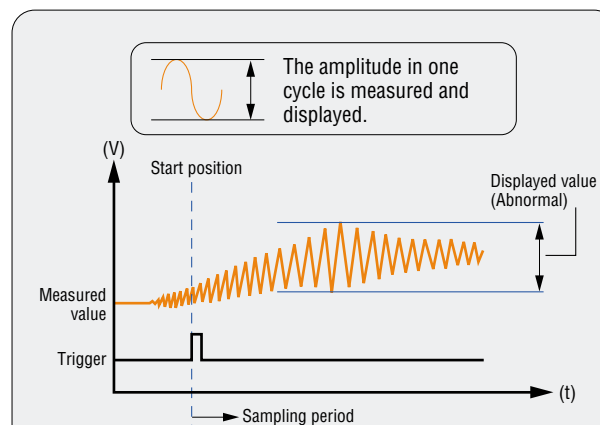

Measurement automatically starts when the amplitude exceeds the specified value. If the amplitude exceeds the tolerance range, an output is produced to indicate abnormal vibration.

Thickness/gap mode

Continuous Average Internal timer

Measures the average thickness of the desired section with a simple setting.

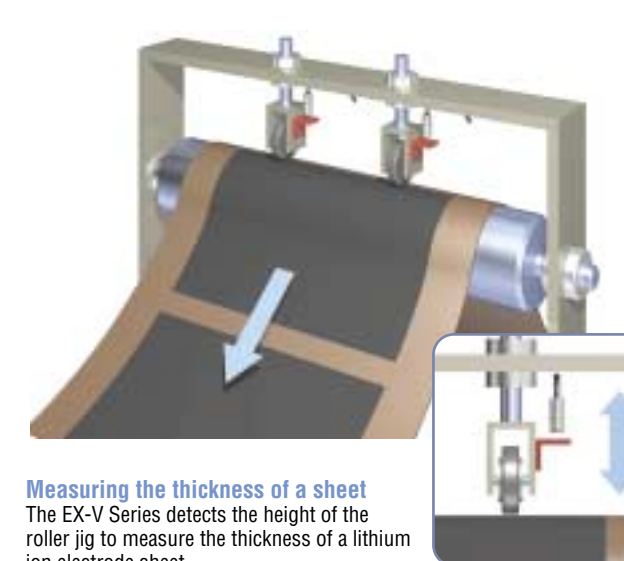

Measuring the thickness of a sheet
The EX-V Series detects the height of the roller jig to measure the thickness of a lithium ion electrode sheet.

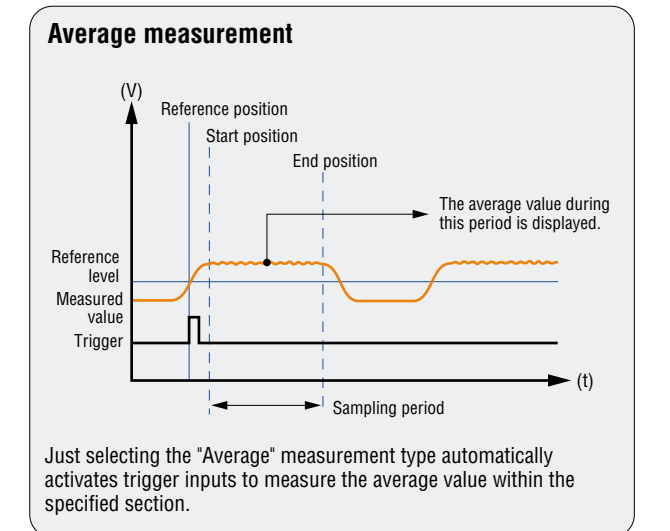

Just selecting the "Average" measurement type automatically activates trigger inputs to measure the average value within the specified section.

Select the program best suited for your application.

Various measurement modes

You can select the measurement mode best suited for your application, such as the limited bottom-dead-center mode or difference between peaks (bottoms) mode.

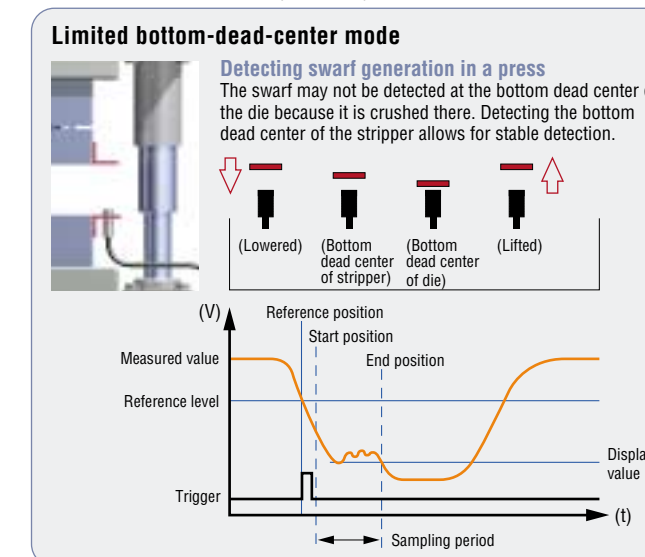

Automatic trigger

When a target approaches the sensor, a trigger signal is automatically turned ON to start measurement. There is no need for an external trigger input or timer setting.

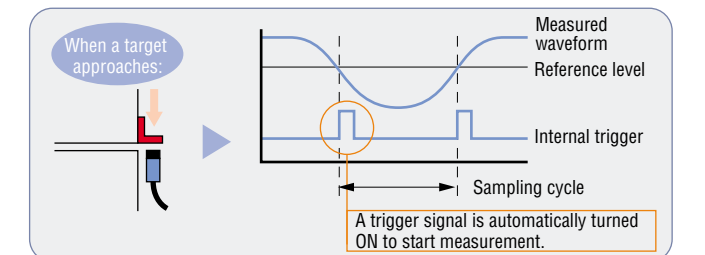

Timer function

The flicker function using the internal timer allows for measurement of the average value or vibration within a specified period. Moreover, the timer enables adjustment of the start or end point of measurement from the instant the automatic trigger is turned ON.

Previous value comparison

The latest measured value can be compared with the average value of the previous measurements. This allows for the detection of only abrupt changes without being affected by changes over time.

Various Functions for Every Need

Measurement period output

The measurement period for bottom-dead-center or eccentricity detection can be specified by strobe outputs. By connecting the EX-V Series to an oscilloscope or other device, you can adjust the device while monitoring a waveform.







Tolerance limit memory function

Up to four upper/lower tolerance limit settings can be stored in memory. You can switch these settings also by external signals. This makes changeover quick and easy.

Comparator output disable input

The comparator output can be stopped with external signals. While continuing comparator operation, you can stop the output until the device operation stabilizes.

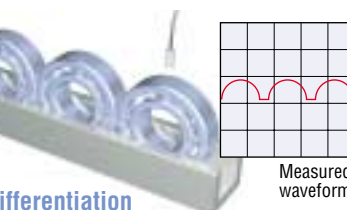
Applications by Facility/Product

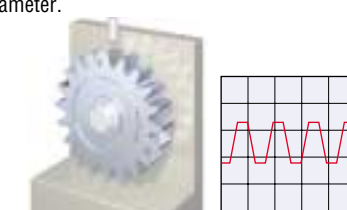
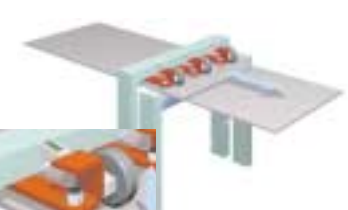
	Electric machinery/electronics	Metal/automobile	Plastic/paper
Facility	 <p>Detecting improper crimping Improper crimping can be detected by checking the bottom dead center of the machine.</p>	 <p>Measuring the eccentricity of ATC tools Eccentricity due to trapped swarf can be detected.</p>	 <p>Measuring the distortion of a die for an injection molding machine The amount of distortion can be measured by comparing the measured values before and after the load is applied.</p>
	 <p>Checking the origin of the X-Y stage The resolution of 0.4 μm enables accurate measurement of the position of the origin.</p>	 <p>Measuring the elongation of a tie bar The elongation of the tie bar of a die-cast machine can be measured by using a magnet jig.</p>	 <p>Detecting the surface runout of a slitter blade The eccentricity mode automatically detects the surface runout exceeding the reference value.</p>
Product	 <p>Measuring the surface runout of a disk The eccentricity mode detects the surface runout of a disk.</p>	 <p>Differentiation of the outer diameter of a bearing The bottom-dead-center mode detects the point where the bearing comes the closest to the sensor head to differentiate the outer diameter.</p>	 <p>Measuring the gap between rollers The gap between the molding rollers can be accurately measured.</p>
	 <p>Measuring subtle vibration of a precision motor Detecting abnormal vibration prevents defective products from being sent to the next process.</p>	 <p>Detecting the eccentricity of a gear Setting the eccentricity mode to the difference between peaks measurement type detects the eccentricity in gear teeth tops.</p>	 <p>Detecting double-fed paper bags Detecting the movement of a jig allows for differentiation between one and two paper bags.</p>

Selection Chart

Controller



EX-V Series

Sensor head

Shape	Measuring range	Resolution	Model
ø5.4 x 18mm	1 mm	0.4 μm	EX-305V
M10 x 18mm	2 mm	0.4 μm	EX-110V
M16 x 20mm	5 mm	1 μm	EX-416V
ø22 x 35mm	10 mm	2 μm	EX-422V
14 x 30 x 4.8mm	4 mm	1 μm	EX-614V

Specifications

Model	Cylindrical		Threaded		Cylindrical, threaded		Thin profile
	ø5.4 x 18 mm	M10 x 18 mm	M16 x 20 mm	ø22 x 35 mm	14x30x4.8 mm		
Shape	Sensor head		EX-305V	EX-110V	EX-416V	EX-422V	EX-614V
	Controller		EX-V01	EX-V02	EX-V05	EX-V10	EX-V64
Measuring range	0 to 1 mm 0.04"		0 to 2 mm 0.08"		0 to 5 mm 0.20"		0 to 10 mm 0.39"
Display range	-19999 to 19999						
Linearity	±0.3% of F.S.						
Resolution	0.4 μm	0.4 μm	1 μm	2 μm	1 μm		
Sampling rate	40000 samples max./sec. ¹						
Display rate	20/sec.						
Display character	7-segment 2-color LED						
Range-over alarm	±FFFF is displayed.						
Control input	Timing input						
	Reset input						
	Auto-zero input						
	Comparator output disable input						
	Synchronous input						
Control output	External setting input						
	Tolerance setting						
	Signal						
	Response time						
Off-delay time							
Upper/lower 2-level setting x 4 sets (selectable)							
NPN open-collector (HIGH, GO and LOW): 100 mA max. (40 V max.)							
0.075 ms (at maximum speed)							
60 ms							
NPN open-collector: 100 mA max. (40 V max.), Residual voltage: 1 V max. (N.O.)							
NPN open-collector: 100 mA max. (40 V max.), Residual voltage: 1 V max. (N.C.)							
±5 V							
100 Ω							
0.075 ms (at maximum speed)							
0.07% of F.S./°C ²							
24 VDC±10%, Ripple (P-P): 10% max.							
240 mA max.							
-10 to +60°C (14 to 140 °F), No freezing							
0 to +50°C (32 to 122 °F), No freezing							
35 to 85%, No condensation							
10 to 55 Hz, 1.5 mm double amplitude in X, Y and Z directions, 2 hours respectively							
Weight	Sensor head (including 3-m cable)		Approx. 45 g	Approx. 55 g	Approx. 75 g	Approx. 200 g	Approx. 60 g
	Controller		Approx. 235 g				
Auto-zero function, Offset function, Measurement modes (15 types), Tolerance limit value memory function (4 patterns)							

1. When the digital filter function is used, the sampling rate is 20000 sampling/sec.
 2. When the distance between the sensor head and the target is within 50% of the measuring range.
 3. The above data was obtained using an iron target (S45C, SS41, t = 1 mm 0.04"). When measuring aluminum, copper, or stainless steel targets, refer to the linear characteristics for these materials.

Various Functions for Every Need

Measurement period output

The measurement period for bottom-dead-center or eccentricity detection can be specified by strobe outputs. By connecting the EX-V Series to an oscilloscope or other device, you can adjust the device while monitoring a waveform.









Tolerance limit memory function

Up to four upper/lower tolerance limit settings can be stored in memory. You can switch these settings also by external signals. This makes changeover quick and easy.

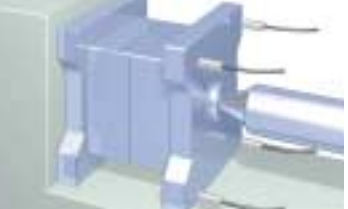
Comparator output disable input

The comparator output can be stopped with external signals. While continuing comparator operation, you can stop the output until the device operation stabilizes.

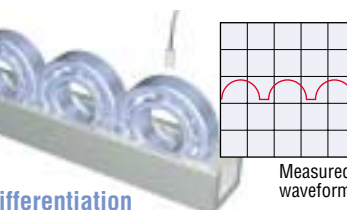
Applications by Facility/Product

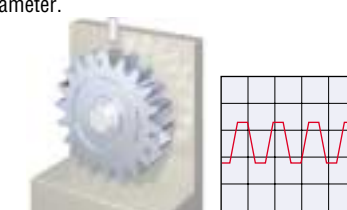
	Electric machinery/electronics	Metal/automobile	Plastic/paper
Facility	 <p>Detecting improper crimping Improper crimping can be detected by checking the bottom dead center of the machine.</p>	 <p>Measuring the eccentricity of ATC tools Eccentricity due to trapped swarf can be detected.</p>	 <p>Measuring the distortion of a die for an injection molding machine The amount of distortion can be measured by comparing the measured values before and after the load is applied.</p>
	 <p>Checking the origin of the X-Y stage The resolution of 0.4 μm enables accurate measurement of the position of the origin.</p>	 <p>Measuring the elongation of a tie bar The elongation of the tie bar of a die-cast machine can be measured by using a magnet jig.</p>	 <p>Detecting the surface runout of a slitter blade The eccentricity mode automatically detects the surface runout exceeding the reference value.</p>
Product	 <p>Measuring the surface runout of a disk The eccentricity mode detects the surface runout of a disk.</p>	 <p>Differentiation of the outer diameter of a bearing The bottom-dead-center mode detects the point where the bearing comes the closest to the sensor head to differentiate the outer diameter.</p>	 <p>Measuring the gap between rollers The gap between the molding rollers can be accurately measured.</p>
	 <p>Measuring subtle vibration of a precision motor Detecting abnormal vibration prevents defective products from being sent to the next process.</p>	 <p>Detecting the eccentricity of a gear Setting the eccentricity mode to the difference between peaks measurement type detects the eccentricity in gear teeth tops.</p>	 <p>Detecting double-fed paper bags Detecting the movement of a jig allows for differentiation between one and two paper bags.</p>

Selection Chart

Controller



EX-V Series

Sensor head

Shape	Measuring range	Resolution	Model
ø5.4 x 18mm	1 mm	0.4 μm	EX-305V
M10 x 18mm	2 mm	0.4 μm	EX-110V
M16 x 20mm	5 mm	1 μm	EX-416V
ø22 x 35mm	10 mm	2 μm	EX-422V
14 x 30 x 4.8mm	4 mm	1 μm	EX-614V

Specifications

Model	Cylindrical		Threaded		Cylindrical, threaded		Thin profile
	ø5.4 x 18 mm	M10 x 18 mm	M16 x 20 mm	ø22 x 35 mm	14x30x4.8 mm		
Shape	Sensor head		EX-305V	EX-110V	EX-416V	EX-422V	EX-614V
	Controller		EX-V01	EX-V02	EX-V05	EX-V10	EX-V64
Measuring range	0 to 1 mm 0.04"		0 to 2 mm 0.08"		0 to 5 mm 0.20"		0 to 10 mm 0.39"
Display range	-19999 to 19999						
Linearity	±0.3% of F.S.						
Resolution	0.4 μm	0.4 μm	1 μm	2 μm	1 μm		
Sampling rate	40000 samples max./sec. ¹						
Display rate	20/sec.						
Display character	7-segment 2-color LED						
Range-over alarm	±FFFF is displayed.						
Control input	Timing input						
	Reset input						
	Auto-zero input						
	Comparator output disable input	NPN open-collector or non-voltage contact					
	Synchronous input						
Control output	External setting input						
	Tolerance setting	Upper/lower 2-level setting x 4 sets (selectable)					
	Signal	NPN open-collector (HIGH, GO and LOW): 100 mA max. (40 V max.)					
Response time	0.075 ms (at maximum speed)						
	Off-delay time	60 ms					
Strobe output	NPN open-collector: 100 mA max. (40 V max.), Residual voltage: 1 V max. (N.O.)						
Alarm output	NPN open-collector: 100 mA max. (40 V max.), Residual voltage: 1 V max. (N.C.)						
Analog voltage output	Output voltage	±5 V					
	Impedance	100 Ω					
Response time	0.075 ms (at maximum speed)						
Temperature fluctuation	0.07% of F.S./°C ²						
Power supply	24 VDC±10%, Ripple (P-P): 10% max.						
Current consumption	240 mA max.						
Ambient temperature	Sensor head	-10 to +60°C (14 to 140 °F), No freezing					
	Controller	0 to +50°C (32 to 122 °F), No freezing					
Relative humidity	35 to 85%, No condensation						
Vibration	10 to 55 Hz, 1.5 mm double amplitude in X, Y and Z directions, 2 hours respectively						
Weight	Sensor head (including 3-m cable)	Approx. 45 g	Approx. 55 g	Approx. 75 g	Approx. 200 g	Approx. 60 g	
	Controller	Approx. 235 g					
Major functions	Auto-zero function, Offset function, Measurement modes (15 types), Tolerance limit value memory function (4 patterns)						

1. When the digital filter function is used, the sampling rate is 20000 sampling/sec.
2. When the distance between the sensor head and the target is within 50% of the measuring range.
3. The above data was obtained using an iron target (S45C, SS41, t = 1 mm 0.04"). When measuring aluminum, copper, or stainless steel targets, refer to the linear characteristics for these materials.

Dimensions

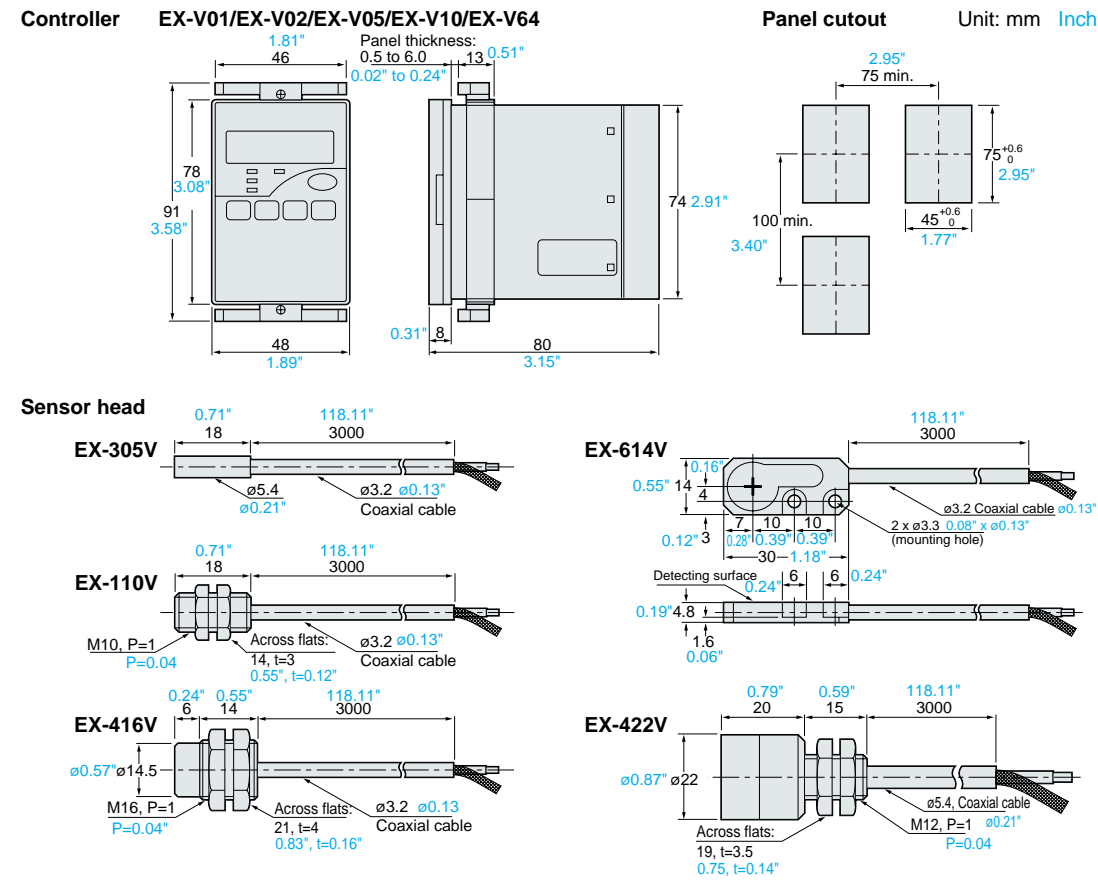

NEW High-speed, High-Accuracy Digital Displacement Inductive Sensor EX-V Series

Options



OP-35407 Mounting stand

The stand has two 16-mm diameter mounting holes for attaching a push-button switch for reset input or comparator output disable input.
 * The switch is not included. Contact KEYENCE for details.

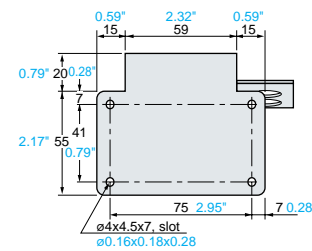

Visit our website for other Keyence products at www.keyence.com

Specifications are subject to change without notice.



KEYENCE CORPORATION OF AMERICA
 Corporate Office
 50 Tice Blvd., Woodcliff Lake, NJ 07677, U.S.A.

Boston Office
 Phone: 781-453-2244 Fax: 781-453-2255

New Jersey Office
 Phone: 201-291-4000 Fax: 201-291-8860

Pennsylvania Office
 Phone: 610-768-8993 Fax: 610-337-1067

Charlotte Office
 Phone: 704-423-0070 Fax: 704-423-0066

Atlanta Office
 Phone: 770-951-1222 Fax: 770-951-1958

Tampa Office
 Phone: 813-998-9886 Fax: 813-998-9887

Cleveland Office
 Phone: 216-464-7530 Fax: 216-464-7540

Columbus Office
 Phone: 614-799-3400 Fax: 614-799-3401

Cincinnati Office
 Phone: 513-554-1227 Fax: 513-554-1229

Michigan Office
 Phone: 734-591-9922 Fax: 734-591-1722

Indianapolis Office
 Phone: 317-843-2616 Fax: 317-843-2647

Chicago Office
 Phone: 847-969-0001 Fax: 847-969-0453

Minneapolis Office
 Phone: 952-924-9779 Fax: 952-249-9143

St. Louis Office
 Phone: 314-275-9174 Fax: 314-275-9175

Texas Office
 Phone: 972-733-6790 Fax: 972-733-6791

Denver Office
 Phone: 303-756-5242 Fax: 303-756-8301

Phoenix Office
 Phone: 602-225-2400 Fax: 602-225-2425

Portland Office
 Phone: 503-699-0500 Fax: 503-699-8400

Northern California Office
 Phone: 925-225-1550 Fax: 925-225-1440

Los Angeles Office
 Phone: 310-851-8635 Fax: 310-851-8681

© KEYENCE CORPORATION, 2000 EXV-KA-C-2-0302 Printed in Japan

High-speed Sub-micron Displacement Sensor with 40,000 Samples/sec.

High Accuracy Inductive Gauging Technology





Artisan Technology Group is your source for quality new and certified-used/pre-owned equipment

- FAST SHIPPING AND DELIVERY
- TENS OF THOUSANDS OF IN-STOCK ITEMS
- EQUIPMENT DEMOS
- HUNDREDS OF MANUFACTURERS SUPPORTED
- LEASING/MONTHLY RENTALS
- ITAR CERTIFIED SECURE ASSET SOLUTIONS

SERVICE CENTER REPAIRS

Experienced engineers and technicians on staff at our full-service, in-house repair center

*InstraView*SM REMOTE INSPECTION

Remotely inspect equipment before purchasing with our interactive website at www.instraview.com ↗

WE BUY USED EQUIPMENT

Sell your excess, underutilized, and idle used equipment. We also offer credit for buy-backs and trade-ins. www.artisanng.com/WeBuyEquipment ↗

LOOKING FOR MORE INFORMATION?

Visit us on the web at www.artisanng.com ↗ for more information on price quotations, drivers, technical specifications, manuals, and documentation

Contact us: (888) 88-SOURCE | sales@artisanng.com | www.artisanng.com