



Artisan Technology Group is your source for quality new and certified-used/pre-owned equipment

- FAST SHIPPING AND DELIVERY
- TENS OF THOUSANDS OF IN-STOCK ITEMS
- EQUIPMENT DEMOS
- HUNDREDS OF MANUFACTURERS SUPPORTED
- LEASING/MONTHLY RENTALS
- ITAR CERTIFIED SECURE ASSET SOLUTIONS

SERVICE CENTER REPAIRS

Experienced engineers and technicians on staff at our full-service, in-house repair center

*InstraView*SM REMOTE INSPECTION

Remotely inspect equipment before purchasing with our interactive website at www.instraview.com ↗

WE BUY USED EQUIPMENT

Sell your excess, underutilized, and idle used equipment. We also offer credit for buy-backs and trade-ins. www.artisanng.com/WeBuyEquipment ↗

LOOKING FOR MORE INFORMATION?

Visit us on the web at www.artisanng.com ↗ for more information on price quotations, drivers, technical specifications, manuals, and documentation

Contact us: (888) 88-SOURCE | sales@artisanng.com | www.artisanng.com

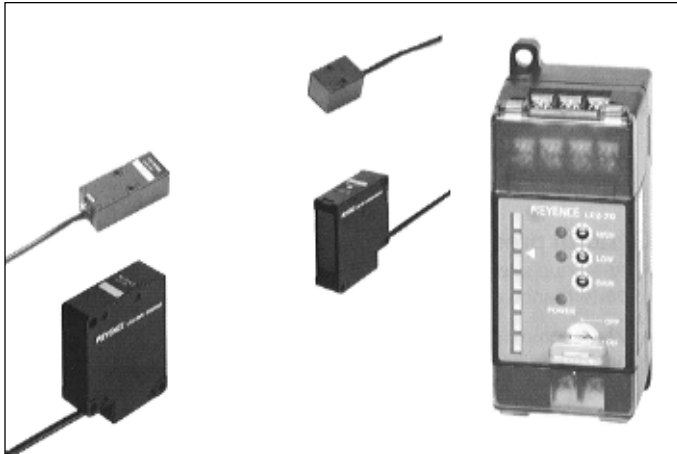

Instruction Manual

Laser Thrubeam
Photoelectric Sensor
LX2(W) Series

CONTENTS

SAFETY Information for LX2 series	2
Precautions for Handling the LX2(W) Series	3
Method for Insulating the Sensor Head from the Mounting Surface	4
Safety Precautions on Laser Product	5
Part Names	10
Connections	11
Alignment of Optical Axis	12
Tolerance Setting	14
Hints on Correct Use	15
Specifications	16
Dimensions	18
WARRANTY	20

CAUTION

Avoid mounting the sensor head in a place where electrostatic potential can build up or which is subject to EMI. If any electrostatic potential reaches the sensor head, the sensor's laser diode may be damaged. If such a possibility exists, ground the place where the sensor head is to be mounted, and insert insulating material between the sensor head and the mounting surface so that the sensor will be static-free. See page 3 and 4 for further information.

SAFETY INFORMATION FOR LX2 SERIES

This manual describes how to install the LX2 Series as well as its operating procedures and precautions. Please read this manual carefully for your safety.

Symbols

The following symbols alert you to important messages. Be sure to read these messages carefully.



Failure to follow instructions may lead to injury. (electric shock, burn, etc.)



Failure to follow instructions may lead to product damage.



Provides additional information on proper operation.

General Safety precautions

- At startup and during operation, be sure to monitor the functions and performance of the LX2 series.
- We recommend that you take substantial safety measures to avoid any damage in the event a problem occurs.
- Do not open or modify the LX2 series or use it in any way other than described in the specifications.
- When the LX2 series is used in combination with other instruments, functions and performance may be degraded, depending on operating conditions and the surrounding environment.
- Do not use this product for the purpose to protect a human body or a part of human body.
- This product is not intended for use as explosion-proof product. Do not use this product in a hazardous location and/or potentially explosive atmosphere.

PRECAUTIONS FOR HANDLING THE LX2(W) SERIES

The LX2 series uses a semiconductor laser diode for the light source. When using the sensor, be sure to follow the precautions given below.

- Before connecting the sensor head to the controller, be sure to turn off the controller's power supply. Otherwise, noise generated due to chattering at the connection may damage the semiconductor laser diode.
- Before performing maintenance or inspection work, be sure to turn off the power supply. Performing maintenance or inspection work with the power on may damage the sensor.
- Do not install the sensor head where water, oil, organic solvent, etc. may splash it. Failure to follow this may cause not only unstable measurement but may also damage the sensor head due to entry of the liquid inside the unit.
- Do not install the power supply cable or sensor head cable in the same conduit as high voltage lines or power lines. Failure to follow this may cause the sensor to malfunction due to noise interference or may damage the semiconductor laser diode.
- Noise conveyed through the power supply may cause a malfunction or damage. In such a case, use an insulating transformer for the power supply to stabilize the DC power supply. When using a switching regulator, be sure to ground the frame-ground and ground terminals.
- The sensor head is grounded through its housing. Therefore, if the sensor head is mounted on a surface to which noise is conveyed, the noise may cause the sensor to malfunction or may damage the semiconductor laser diode. In such a case, insulate the sensor head from the mounting surface. (For the method for insulating the sensor head from the mounting surface, see page 4.)
- Static electricity on the human body or around the sensor head may damage the semiconductor laser diode. Pay special attention to prevent electrostatic discharge when connecting the sensor head and controller. When connecting them, be sure to use an anti-static wrist strap.

METHOD FOR INSULATING THE SENSOR HEAD FROM THE MOUNTING SURFACE

Method 1: When using metallic screws to mount the sensor head

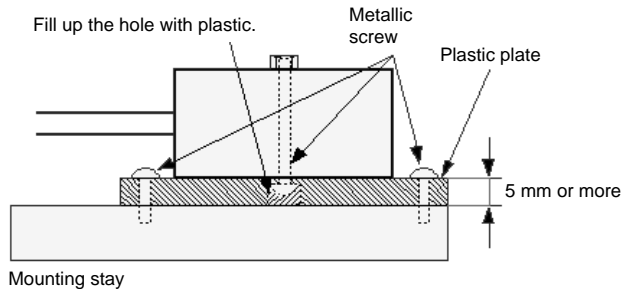

Use an insulating plastic plate with a thickness of 5 mm or more. Though the kind of plastic is not specified, plastic that withstands a higher voltage is preferred (e.g. Teflon, etc.).

Make a hole in the two places on the plastic plate, and insert screws from the bottom surface of the plate to fix the sensor head to the plate. Fill up the holes with silicone or other plastic to prevent the head of the screws from coming into contact with the surface of the mounting stay.

Method 2: When using plastic screws to mount the sensor head

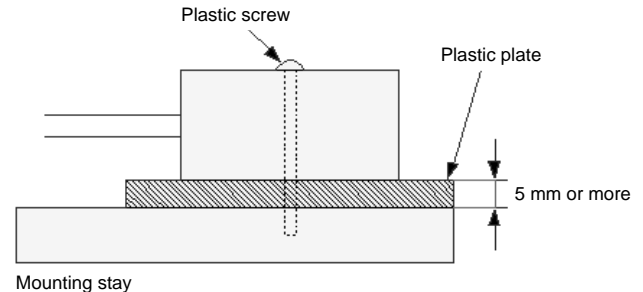

Use an insulating plastic plate with a thickness of 5 mm or more. Though the kind of plastic is not specified, plastic that withstands a higher voltage is preferred (e.g. Teflon, etc.).

Do not use the acrylic plastic screws included with the sensor. Since they do not provide satisfactory strength, the sensor head may be dislocated after mounting.

SAFETY PRECAUTIONS ON LASER PRODUCT

1. Classification

Model	LX2-11(W)	LX2-12(W)	LX2-13(W)	LX2-110(W)
FDA(CDRH) 21CFR Part 1040.10	Class III b		Class I	Class II
IEC/EN 60825-1	Class 3B		Class 1	
DIN EN 60825-1	Class 3B		Class 1	

2. Labels

1) FDA(CDRH) Warning labels

FDA(CDRH) Class II

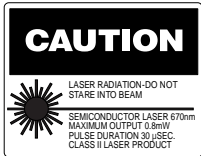

FDA(CDRH) Class IIIb



2) IEC Explanatory/Warning labels

IEC Class 1



IEC (French) Classe 1



DIN Klasse 1



IEC Class 3B

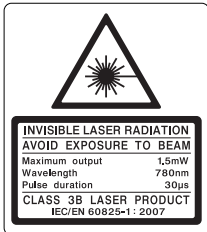

IEC (French) Classe 3B

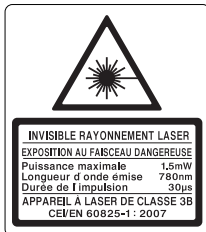

DIN Klasse 3B



3) Aperture label

FDA Class I



IEC Class 3B



FDA Class II



IEC (French) Classe 3B



FDA Class IIIb



DIN Klasse 3B



SAFETY PRECAUTIONS ON LASER PRODUCT

3. Label location (← : Aperture)

FDA Warning labels are attached to the sensor head as shown below. When using this product in the countries and/or regions other than U.S., use the IEC warning/explanatory label in the package of this product. In this case, it can be affixed on the FDA (CDRH) warning label, which has already been affixed to this product.

FDA LX2-110 (W)

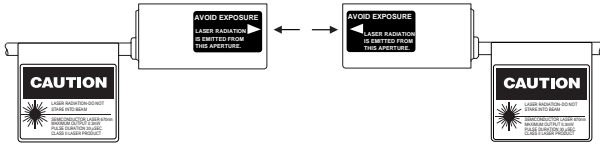

LX2-11 (W)/LX2-12 (W)

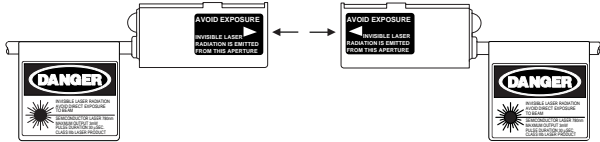

LX2-13 (W)

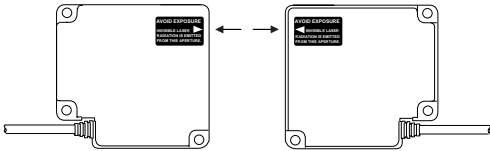

IEC/DIN LX2-13 (W)/LX2-110 (W)

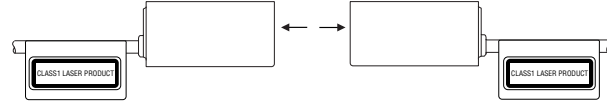

LX2-11 (W)/LX2-12 (W)

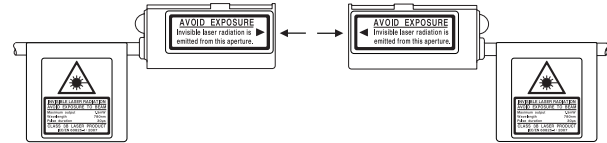

SAFETY PRECAUTIONS ON LASER PRODUCT

4. Safety consideration

 **CAUTION**

Use of controls or adjustments or the performance of procedures other than those specified herein may result in hazardous radiation exposure.

1) Class 3B/IIIb laser products

- **MPE (Maximum Permissible Exposure): 1.9 mW/cm²**

 **WARNING**

Follow the instructions mentioned in this manual. Otherwise, injury to the human body (eyes and skin) may result.

- **Do not directly look at or touch the laser beam and its reflection from a mirror-like surface.**
- **Do not direct the beam at other people or into areas where other people unconnected with the laser work might be present.**
- **Be careful of the path of the laser beam.**
Make the laser path as short as possible and be sure to terminate the laser path with a diffusion reflector or diffusion absorber with proper reflectance and thermal characteristics so that the laser beam does not diffuse. (It is recommended that you install a protective enclosure.)
- **Install the laser product carefully so that the laser beam is not unintentionally directed at mirror-like surfaces.**
- **Install the products so that the path of the laser beam is not as the same height as that of human eye.**
- **Wear protective eye goggles appropriate for the laser beam wavelength.**

- **Do not disassemble this product.**
Laser emission from this product is not automatically stopped when it is disassembled.
- **Clean the aperture regularly.**
In addition, stop the emission of the laser beam when cleaning.

SAFETY PRECAUTIONS ON LASER PRODUCT

2) Class II and Class 1/I laser products

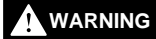

Follow the instructions mentioned in this manual. Otherwise, injury to the human body (eyes and skin) may result.

- **Do not stare into the beam.**
- **Do not direct the beam at other people or into areas where other people unconnected with the laser work might be present.**
- **Be careful of the path of the laser beam.**

If there is a danger that the operator may be exposed to the laser beam reflected by specular or diffuse reflection, block the beam by installing an enclosure with the appropriate reflectance.

- **Install the products so that the path of the laser beam is not as the same height as that of human eye.**
- **Do not disassemble this product.**

Laser emission from this product is not automatically stopped when it is disassembled.

SAFETY PRECAUTIONS ON LASER PRODUCT

5. Safety features provided with the LX2 series

The LX2 series is provided with the following safety features. Make sure these features function correctly before making any measurement.

1. Laser radiation emission warning

A visible LED that informs you that the laser beam is being emitted, or is about to be emitted, at least 3 seconds after power is provided to the amplifier and the sensor head.

2. Laser emission delay

Laser emission only starts when the LED has been ON/lit for at least 3 seconds, thus decreasing the possibility of laser exposure.

3. Laser emission remote control terminals

Terminals for controlling laser emission are provided on the front of the amplifier. You can remotely control laser emission using these terminals.

4. Key operated switch

Set to the ON position to supply power.
You can lock the controlling power switch using the supplied key, which can be removed only when set to the OFF position.

5. Beam attenuator

A beam attenuator is supplied. This cover is to be attached to the laser-beam-emitting portion of the sensor head. If an operator must work in front of the sensor head and there is risk to the eyes from the laser beam, be sure to attach this shield.

For use with shield:

Attach the shield to the front surface of the transmitter lens.

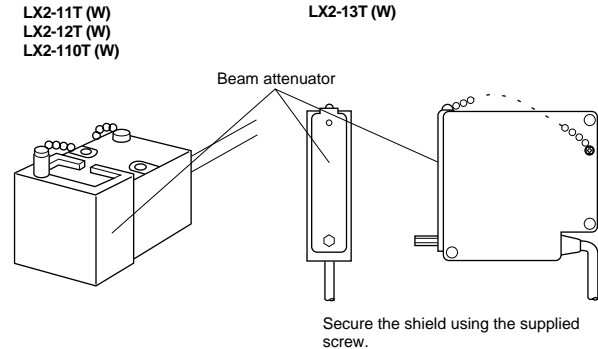

For use without shield [LX2-13T(W)]:

Secure the shield to the screw hole on the rear of the sensor head using the supplied screw.

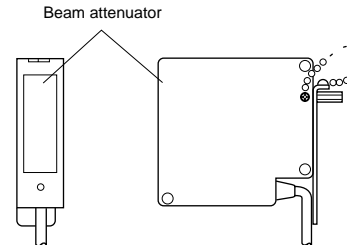

PART NAMES

Sensor head

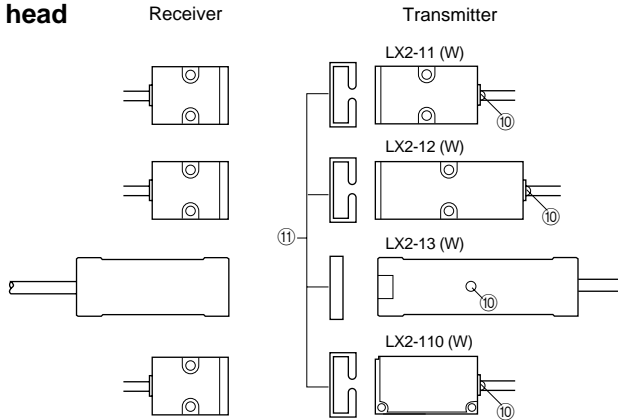

Amplifier

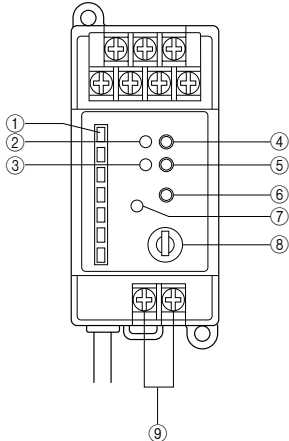

- ① **Level indicator for adjusting optical axis**
Number of LEDs lit corresponds to light quantity received. Refer to this indicator when aligning laser optical axis.
- ② **HIGH (upper limit) output LED indicator**
Lights when HIGH output is ON .
- ③ **LOW (lower limit) output LED indicator**
Lights when LOW output is ON.
- ④ **HIGH-trimmer**
Used to set HIGH (upper limit) output level.
- ⑤ **LOW-trimmer**
Used to set LOW (lower limit) output level.
- ⑥ **Analog voltage adjustment trimmer (GAIN trimmer)**
Used for fine SPAN-adjustment of analog output voltage when adjusting optical axis alignment.
- ⑦ **Power LED indicator**
Lights when power is ON.
- ⑧ **Key operated switch**
- ⑨ **Laser emission remote control terminals**
Laser beam emission will stop when these terminals are open circuited.
- ⑩ **Laser radiation emission warning**
Lights when the laser beam is being emitted or is about to be emitted. This LED does not turn off while power is being supplied by the amplifier.
- ⑪ **Beam attenuator**

CONNECTIONS

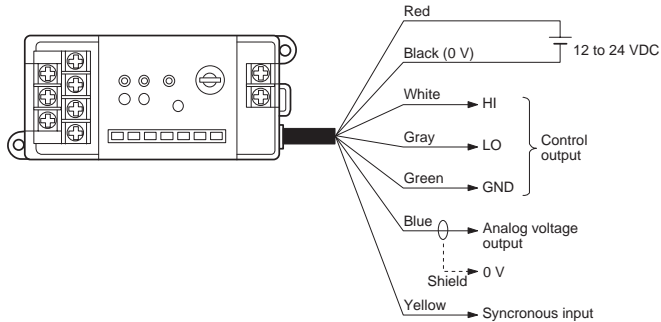

The black (0 V) and shielded (0 V) wires have a different electrical potential. The green (GND) wire is also isolated from both 0 V wires. To avoid a malfunction due to excessive noise interference, do not connect any two of these wires.

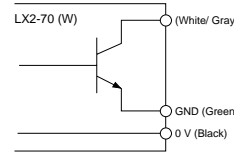

LX2-70

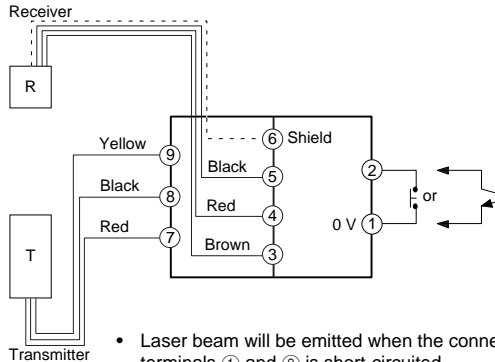

- Laser beam will be emitted when the connection between terminals ① and ② is short-circuited.
- Laser beam emission will stop when the connection between terminals ① and ② is open.
- Short-circuiting the yellow (timing input) and black (0 V) lines will forcibly turn the control output (white, gray and green lines) OFF.

LX2-70W

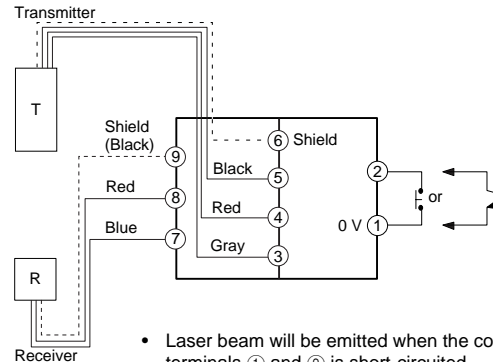

- Laser beam will be emitted when the connection between terminals ① and ② is short-circuited.
- Laser beam emission will stop when the connection between terminals ① and ② is open.
- Short-circuiting the yellow (timing input) and black (0 V) lines will forcibly turn the control output (white, gray and green lines) OFF.

ALIGNMENT OF OPTICAL AXIS

1. Analog voltage output

The LX2-70(W) outputs an analog voltage according to the interrupted area of the laser beam. The relationship between the interrupted area and the analog output voltage is shown in the graph below.

Analog voltage output vs. Interrupted area of laser beam (Typical)
LX2-11(W)/12(W)/13(W)

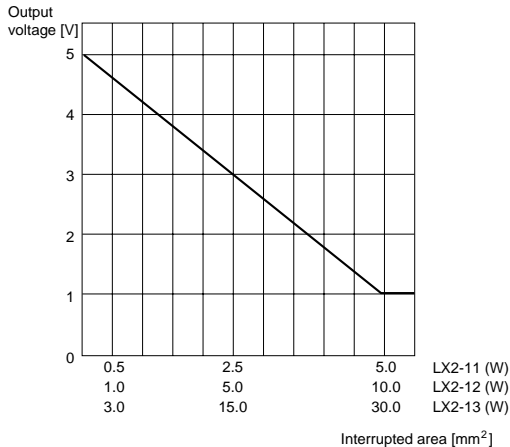

This graph shows the relationship between the interrupted area of the laser beam and the analog output voltage; however the data in this graph are not representative of LX2 characteristics.

2. Optical axis

The optical axis of the LX2 is factory-aligned so that the relationship between the interrupted area and the analog output voltage can be plotted as shown above.

For instant optical axis adjustment, the bottom surfaces of the transmitter and the receiver, and the right side of the transmitter and the receiver (when viewed from the transmitter to the receiver) are designed to be aligned. Set the both sides of transmitter and receiver to align to the same plane level. Otherwise, follow the alignment procedure below.

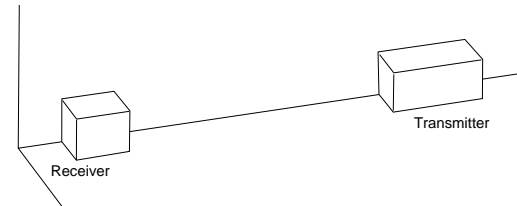

The resin plate provided with the sensor head is a test jig. Remove the resin plate from the sensor head before you operate the LX2.

ALIGNMENT OF OPTICAL AXIS

3. Alignment procedure

■ LX2-11(W)/12(W)/13(W)

If a common reference plane is not available, or if fine alignment of the optical axis is required, follow the procedure described below.

1. Place the laser emitting surface of the transmitter in front of the laser receiving surface of the receiver while the power is ON. Then, adjust the analog voltage adjustment trimmer (GAIN trimmer) so that the five green LEDs and one red LED on the level indicator light.

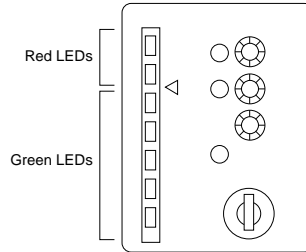

2. Next, fix the receiver, with no object interrupting the optical axis, and move the transmitter to the right or left until both red LEDs on the level indicator light. Secure the transmitter.

3. Readjust the analog voltage adjustment trimmer so that the five green LEDs and one red LED on the level indicator light.

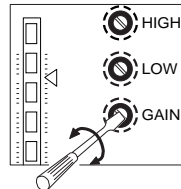

When the interrupted area of the laser beam is zero (0) mm² (that is, when full light quantity is received), the LX2 outputs an analog voltage of 5.00 V. The analog voltage adjustment trimmer can be precisely adjusted using a voltmeter across the core wire of the blue cable and the shield cable.

■ LX2-110(W)

1. Place the transmitter and the receiver at the position desired.
2. Adjust the direction of transmitter while checking the laser beam spot focusing on the center of receiving surface of receiver.
3. Follow the above procedure 3 in the left.

Reference distance vs. Beam diameter (Typical) LX2-110(W)

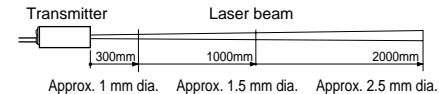

Analog voltage output vs. Interrupted area of laser beam (Typical) LX2-110(W)

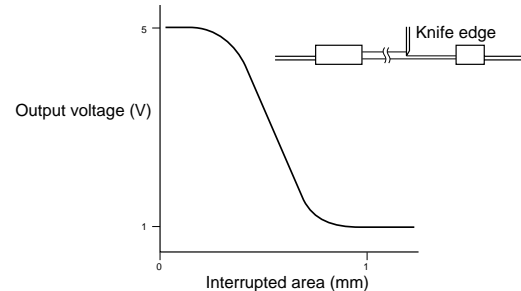

TOLERANCE SETTING

Within the detecting area of the sensor head, the maximum allowable target size (largest allowable interrupted area) is specified by the HIGH trimmer, and the minimum allowable target size (smallest allowable interrupted area) is specified by the LOW trimmer.

1. HIGH output setting

1. Turn the HIGH trimmer counterclockwise until the HIGH (upper limit) output indicator goes off.
2. Place an object of maximum allowable size in the detecting area.
3. Turn the HIGH trimmer clockwise until the HIGH (upper limit) output indicator just lights.

2. LOW output setting

1. Turn the LOW trimmer clockwise until the LOW (lower limit) output indicator goes off.
2. Place an object of minimum allowable size in the detecting area.
3. Turn the LOW trimmer counterclockwise until the LOW (lower limit) output indicator just lights.

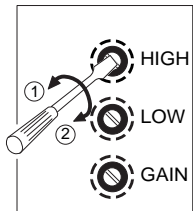

HIGH output setting

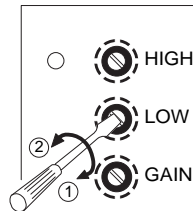

LOW output setting

HINTS ON CORRECT USE

Compatibility

A transmitter and receiver with the same serial number have been calibrated as a pair. Therefore, be sure to use transmitter and receiver with the same serial number in order to satisfy specifications.

*The sensor head and the amplifier are compatible.

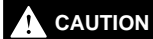

Be sure to use a "W" type amplifier in combination with a "W" type sensor head. If you connect a non "W" type amplifier to a "W" type sensor head, it may cause an electric shock or may burnout the amplifier or the sensor.

Power supply

When using a commercially available switching regulator, be sure to correctly ground the chassis ground or earth ground terminal.

Wiring

Route the wiring of the sensor head in a metal conduit separate from high-voltage cables, power cables, and signal cables that generate EMI. Otherwise, the sensor head and controller may malfunction.

Mounting the sensor head

- Install the transmitter and receiver so that the mounting holes of both devices are positioned in the same plane.
- Do not install the sensor head in a place subject to vibrations.

Environment

- Always keep transmitting and receiving surfaces of the sensor head free from materials which may refract the laser beam (such as water or oil).
- When the lenses become soiled, clean with a dry and soft cloth. Do not use an organic solvent.
- If there are air layers of different temperature between the LX2-110 transmitter and receiver, this may cause a deterioration in resolution.

Monitor output cable (blue)

If the monitor output cable (blue) and the shielding cable are short-circuited, the LX series will not operate. If this condition is maintained for a prolonged period, the amplifier may become damaged.

Extending the cable between the amplifier and sensor head

If the cable between the amplifier and the sensor head is extended, the LX2 series is more likely to be affected by interference, which may result in poor resolution. Do not extend the sensor cable.



Do not connect the sensor head while power is supplied to the amplifier.

SPECIFICATIONS

Sensor head

Type	Ultra narrow beam		Narrow beam	Standard	Wide beam
Model	LX2-110(W)		LX2-11(W)	LX2-12(W)	LX2-13(W)
Light source	Visible red semiconductor laser		Invisible infrared semiconductor laser		
Wavelength	670 nm		780 nm		
Output	0.2 mW (IEC), 0.8 mW (FDA)		1.5 mW (IEC), 3.0 mW (FDA)		0.2 mW (IEC), 0.1 mW (FDA)
Pulse duration	30 µs		30 µs		30 µs
Laser	FDA(CDRH) 21CFR Part 1040.10	Class II	Class IIIb		Class I
Class	IEC/EN 60825-1	Class 1	Class 3B		Class 1
	DIN EN 60825-1	Class 1	Class 3B		Class 1
Detecting area (width x thickness)	1 mm dia.	1 to 2.5 mm dia.	5 x 1 mm	10 x 1 mm	30 x 1 mm
Detecting distance	0 to 300 mm		0 to 300 mm		
Smallest detectable object	Opaque object with a diameter of 8 µm	Opaque object with a diameter of 8 to 50 µm	0.05 mm dia.	0.1 mm dia.	0.2 mm dia.
Repeatability	5 µm ¹	—	10 µm		30 µm
Ambient light	Incandescent lamp: 5,000 lux Sunlight: 10,000 lux		Incandescent lamp: 5,000 lux Sunlight: 5,000 lux	Incandescent lamp: 10,000 lux Sunlight: 10,000 lux	
Ambient temperature	0 to +40°C (32 to 104°F), No condensation		0 to +50°C (32 to 122°F), No condensation		
Relative humidity	35 to 85%, No condensation				
Vibration	10 to 55 Hz, 1.5 mm double amplitude in X, Y, and Z directions, 2 hours respectively				
Housing	PBT		Aluminum die-cast		
Weight² (including cables)	Transmitter	Approx. 55 g (70 g)	Approx. 90 g (100 g)	Approx. 110 g (120 g)	Approx. 260 g
	Receiver	Approx. 60 g	Approx. 70 g	Approx. 90 g	Approx. 210 g

1. Data obtained at a 20°C (68°F) ambient temperature with half of the laser beam.

2. Values in parenthesis are the weight of the W-type models.

SPECIFICATIONS

Amplifier

Model		LX2-70(W)
Control output		NPN open-collector: 100 mA (40 V) max. x 2
Response time		0.5 ms
Analog output	Voltage	1 to 5 VDC
	Impedance	100 Ω
	Response frequency	1 kHz (-3 dB)
	Temperature fluctuation (Typical)¹	0.1% F.S. /°C
Power supply		12 to 24 DCV \pm 10%, Ripple (p-p): 10% max.
Current consumption²		100 mA max.
Ambient temperature		0 to +50°C (32 to 122°F), No freezing
Relative humidity		35 to 85%, No condensation
Vibration		10 to 55 Hz, 1.5 mm double amplitude in X, Y and Z directions, 2 hours respectively
Weight (including cable)		Approx. 200 g

1. Typical values (when the sensor head is connected). 0.2% of F.S./°C [LX2-110(W)]

2. 110 mA max. [LX2-110(W)]

Detecting area

The detecting area of each model corresponds to the dimensions of the receiver slit.

LX2-11(W)

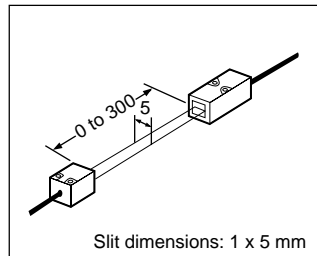

LX2-12(W)

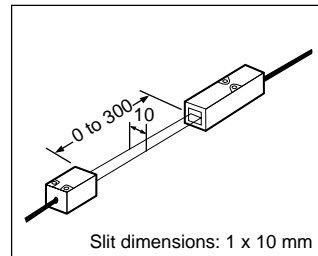

LX2-13(W)

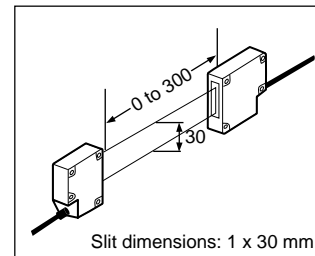

LX2-110(W)

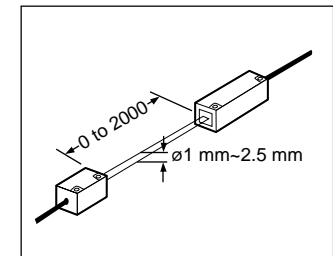

DIMENSIONS

Unit: mm

Sensor head

LX2-11(W)
Receiver

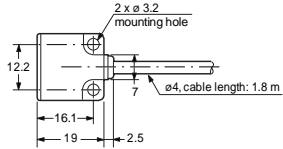

LX2-11(W)
Transmitter

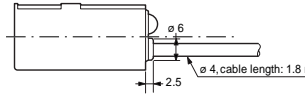
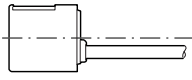
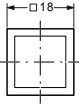
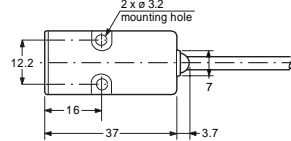

LX2-12(W)
Receiver

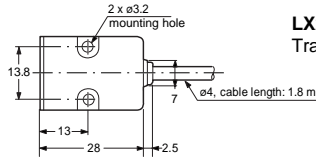

LX2-12(W)
Transmitter

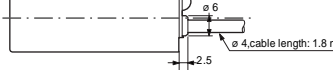
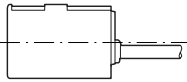
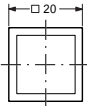
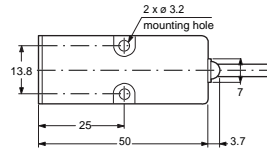

LX2-110(W)
Receiver

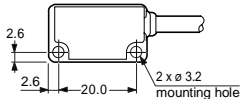

LX2-110(W)
Transmitter

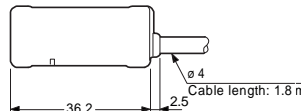
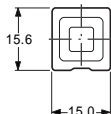
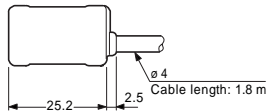
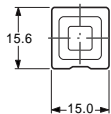
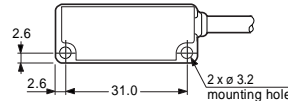

Mounting brackets

For LX2-11(W)/12(W)

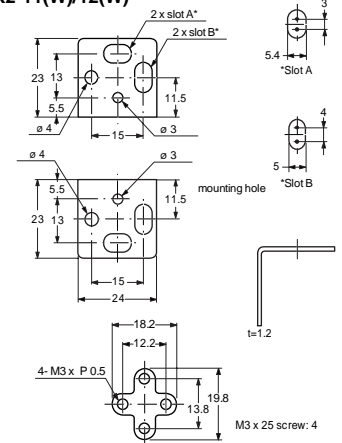

For LX2-110(W)

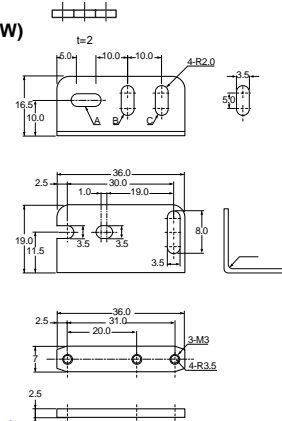

DIMENSIONS

Unit: mm

Sensor head
LX2-13(W)
Receiver

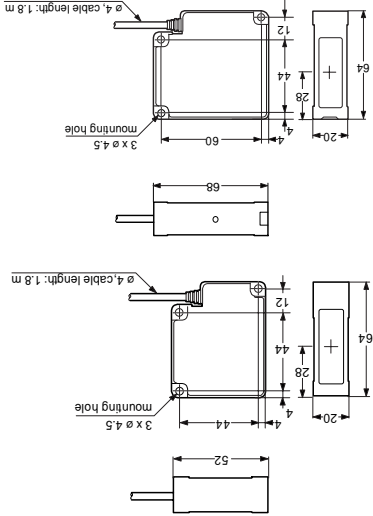

LX2-13(W)
Transmitter

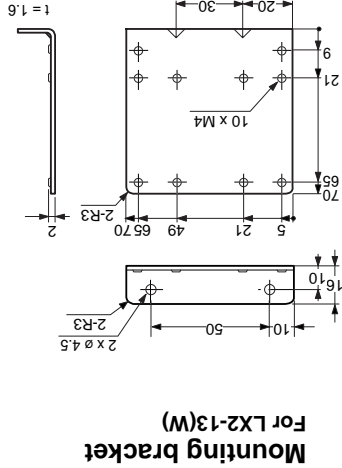

Mounting bracket
For LX2-13(W)

Amplifier
LX2-70(W)

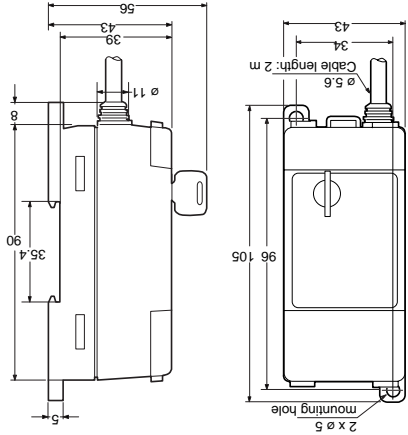

WARRANTY

KEYENCE products are strictly factory-inspected. However, in the event of a failure, contact your nearest KEYENCE office with details of the failure.

1. WARRANTY PERIOD

The warranty period shall be for one year from the date that the product has been delivered to the location specified by the purchaser.

2. WARRANTY SCOPE

- (1) If a failure attributable to KEYENCE occurs within the above mentioned warranty period, we will repair the product, free of charge. However, the following cases shall be excluded from the warranty scope.
- Any failure resulting from improper conditions, improper environments, improper handling, or improper usage other than described in the instruction manual, the user's manual, or the specifications specifically arranged between the purchaser and KEYENCE.
 - Any failure resulting from factors other than a defect of our product, such as the purchaser's equipment or the design of the purchaser's software.
 - Any failure resulting from modifications or repairs carried out by any person other than KEYENCE staff.
 - Any failure that can certainly be prevented when the expendable part(s) is maintained or replaced correctly as described in the instruction manual, the user's manual, etc.
 - Any failure caused by a factor that cannot be foreseen at a scientific/technical level at the time when the product has been shipped from KEYENCE.
 - Any disaster such as fire, earthquake, and flood, or any other external factor, such as abnormal voltage, for which we are not liable.
- (2) The warranty scope is limited to the extent set forth in item (1), and KEYENCE assumes no liability for any purchaser's secondary damage (damage of equipment, loss of opportunities, loss of profits, etc.) or any other damage resulting from a failure of our product.

3. PRODUCT APPLICABILITY

KEYENCE products are designed and manufactured as general-purpose products for general industries. Therefore, our products are not intended for the applications below and are not applicable to them. If, however, the purchaser consults with us in advance regarding the employment of our product, understands the specifications, ratings, and performance of the product on their own responsibility, and takes necessary safety measures, the product may be applied. In this case, the warranty scope shall be the same as above.

- Facilities where the product may greatly affect human life or property, such as nuclear power plants, aviation, railroads, ships, motor vehicles, or medical equipment
- Public utilities such as electricity, gas, or water services
- Usage outdoors, under similar conditions or in similar environments

KEYENCE CORPORATION

1-3-14, Higashi-Nakajima, Higashi-Yodogawa-ku, Osaka, 533-8555, Japan PHONE: +81-6-6379-2211

www.keyence.com

Specifications are subject to change without notice.

Copyright (c) 2010 KEYENCE CORPORATION. All rights reserved. 1450E 1060-1 [96M10789] Printed in Japan

A4WW1-MAN-0069





Artisan Technology Group is your source for quality new and certified-used/pre-owned equipment

- FAST SHIPPING AND DELIVERY
- TENS OF THOUSANDS OF IN-STOCK ITEMS
- EQUIPMENT DEMOS
- HUNDREDS OF MANUFACTURERS SUPPORTED
- LEASING/MONTHLY RENTALS
- ITAR CERTIFIED SECURE ASSET SOLUTIONS

SERVICE CENTER REPAIRS

Experienced engineers and technicians on staff at our full-service, in-house repair center

*InstraView*SM REMOTE INSPECTION

Remotely inspect equipment before purchasing with our interactive website at www.instraview.com ↗

WE BUY USED EQUIPMENT

Sell your excess, underutilized, and idle used equipment. We also offer credit for buy-backs and trade-ins. www.artisanng.com/WeBuyEquipment ↗

LOOKING FOR MORE INFORMATION?

Visit us on the web at www.artisanng.com ↗ for more information on price quotations, drivers, technical specifications, manuals, and documentation

Contact us: (888) 88-SOURCE | sales@artisanng.com | www.artisanng.com