



Artisan Technology Group is your source for quality new and certified-used/pre-owned equipment

- FAST SHIPPING AND DELIVERY
- TENS OF THOUSANDS OF IN-STOCK ITEMS
- EQUIPMENT DEMOS
- HUNDREDS OF MANUFACTURERS SUPPORTED
- LEASING/MONTHLY RENTALS
- ITAR CERTIFIED SECURE ASSET SOLUTIONS

SERVICE CENTER REPAIRS

Experienced engineers and technicians on staff at our full-service, in-house repair center

*InstraView*SM REMOTE INSPECTION

Remotely inspect equipment before purchasing with our interactive website at www.instraview.com ↗

WE BUY USED EQUIPMENT

Sell your excess, underutilized, and idle used equipment. We also offer credit for buy-backs and trade-ins. www.artisanng.com/WeBuyEquipment ↗

LOOKING FOR MORE INFORMATION?

Visit us on the web at www.artisanng.com ↗ for more information on price quotations, drivers, technical specifications, manuals, and documentation

Contact us: (888) 88-SOURCE | sales@artisanng.com | www.artisanng.com

Operating instructions METTLER TOLEDO AG balances



Overview of your AG balance

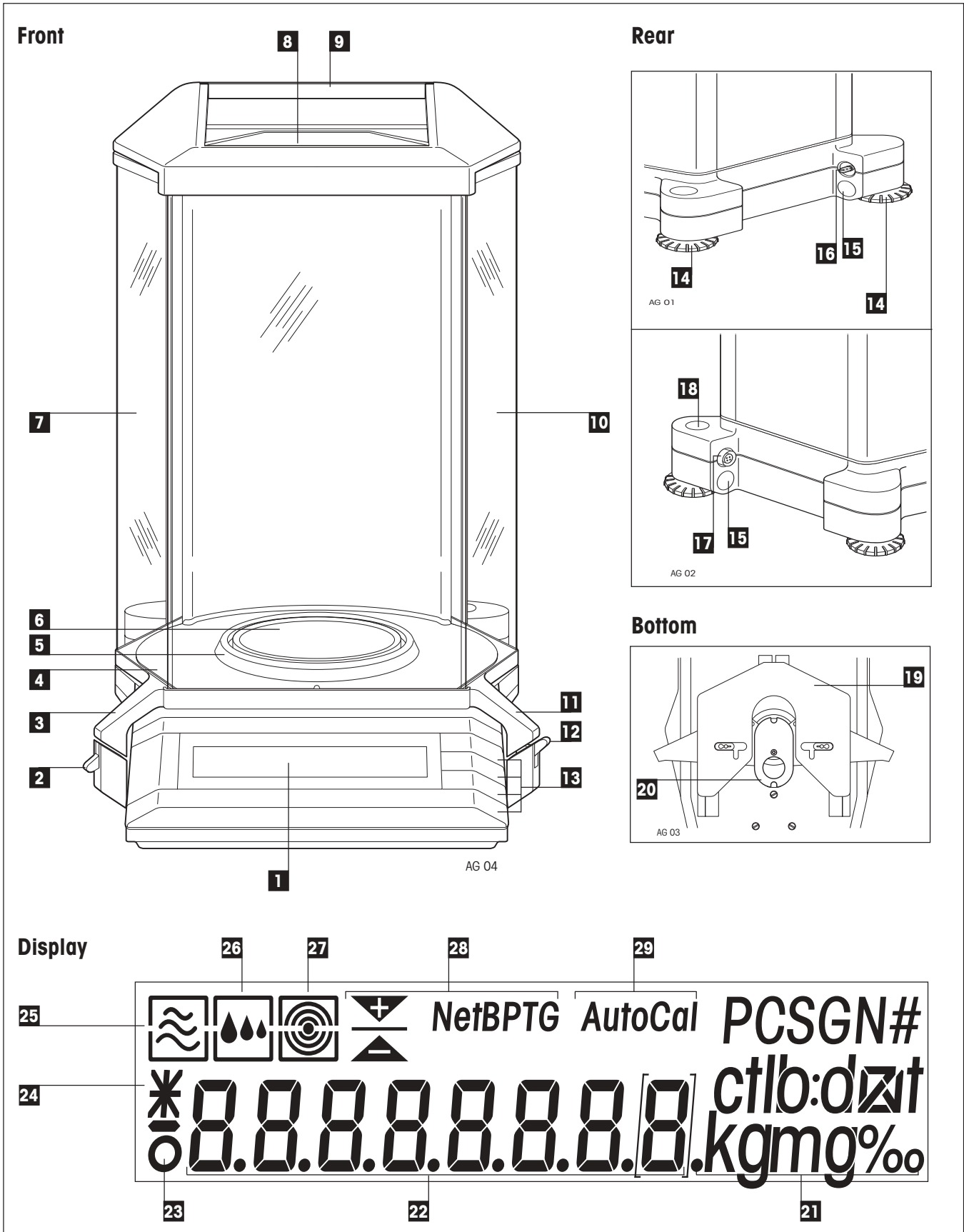

Display, controls and connections of your AG balance

Front

No.	Designation
1	Display
2	Left coupling element for draft shield doors
3	Left door handle
4	Weighing chamber plate
5	Draft shield element (AG135, AG285 only)
6	Weighing pan
7	Left draft shield door
8	Top draft shield door with chamber handle
9	Slide for short-form operating instructions
10	Right draft shield door
11	Right door handle
12	Right coupling element for draft shield doors
13	Operator keys

Rear

No.	Designation
14	Leveling foot
15	Holder for antitheft device
16	Connection socket for AC adapter
17	LocalCAN interface connection
18	Leveling control

Bottom

No.	Designation
19	Mechanism for draft shield operation
20	Cover of hanger (for below-the-balance weighing)

Display

No.	Designation
21	Weighing units
22	Alphanumeric display (result, menu, etc.)
23	Symbol of the stability detector
24	Symbol for calculated result
25	Status indicator of the vibration adapter

No.	Designation
26	Status indicator of the weighing process adapter
27	Status indicator of the repeatability
28	Function displays for special applications
29	Display of calibration mode

Contents

1	Getting to know your AG balance	6
1.1	Introduction	6
1.2	Overview of the AG balances	6
1.3	What you should know about these instructions	7
1.4	Safety has priority	8
2	Putting the balance into operation	9
2.1	Unpacking and checking the standard equipment	9
2.2	Selecting or changing the location	11
2.3	Leveling the balance	12
2.4	Power supply	13
2.5	Affixing short-form operating instructions	14
2.6	Calibrating the balance	15
3	Weighing made simple	17
3.1	Switching the balance on and off	17
3.2	Adapting the draft shield	18
3.3	Taring the balance	19
3.4	Performing a simple weighing	20
3.5	Faster weighing with lower readability	20
3.6	Switching weighing units	21
3.7	The AG135, AG285 dual-range balance	22
3.8	DeltaRange® balances with movable fine range	23
3.9	Printing out weighing result and transferring data	23
4	The menu	24
4.1	What is the menu?	24
4.2	Menu operation	25
4.3	Reset	27
4.4	Selection of the calibration and test function	27
4.5	Switching automatic adjustment call-up on or off	28
4.6	Preselecting a function	29
4.7	Setting the vibration adapter	30

4.8	Setting the weighing process adapter	31
4.9	Selecting the repeatability	32
4.10	Selecting weighing unit 1	33
4.11	Selecting weighing unit 2	34
4.12	Switching the automatic zero-point correction (Auto Zero) on or off	35
4.13	Preselecting the automatic shutdown	36
4.14	Selecting the switch-on mode	37
4.15	Setting display of the icons	37
4.16	Printing out or saving menu settings	38
5	Special applications and functions	39
5.1	Piece counting	39
5.2	Percent weighing	42
5.3	Formulation	43
5.4	Dynamic weighing of unstable weighing samples	47
5.5	Weighing below the balance	49
5.6	Adjustment (calibration) with internal weight	51
5.7	Calibration with external weights (VariCal)	53
5.8	Testing the balance with internal or external weight	55
6	Further important information regarding your AG balance	58
6.1	What if ...?	58
6.2	Error messages	62
6.3	Maintenance and care	64
6.4	LocalCAN universal interface	67
7	Technical data and optional equipment	68
7.1	Technical data of the AG balances	68
7.2	Dimensions	70
7.3	Optional equipment	71
8	Appendix	73
8.1	Overview of menu	73
8.2	Conversion table for weight units	74
8.3	SOP (Standard Operating Procedure)	75
8.4	Index	77

1 Getting to know your AG balance

In this Section you will find basic information regarding your AG balance. Please read this Section through carefully even if you already have experience with METTLER TOLEDO balances and be sure to familiarize yourself with the safety instructions.

1.1 Introduction

Many thanks for choosing a balance from METTLER TOLEDO.

The analytical balances of the AG line combine numerous weighing and adjustment possibilities with an exceptional ease of operation. Thanks to the fully integrated doors of the draft shield, these balance are the most compact of their type and are also equally convenient to operate for right- and left-handers.

Please read through these operating instructions very carefully to ensure that you can exploit all possibilities of your balance. As soon as you are familiar with the functions of your balance, you will be in a position to make use of the enclosed short-form operating instructions in your daily work.

These operating instructions apply to all balances of the AG line. However, the various models have different equipment and performance characteristics. Where this is important for the operation, a special note is inserted in the text.

1.2 Overview of the AG balances

The AG balance family comprises various analytical balances which differ in regard to their weighing range, the resolution and their equipment.

The models of the AG line have the following common features:

- Rugged and chemically resistant construction.
- Extremely compact construction thanks to draft shield doors completely integrated in the weighing chamber.
- Ergonomic, one-handed operation of the draft shield, equally convenient for right- and left-handers.
- Convenient keypad for one-handed operation and wide, easily readable display display with backlighting for some balance models.
- FACT (**F**ully **A**utomatic **C**alibration **T**echnology), fully automatic, motorized adjustment (calibration) with internal weight (naturally, the balance can also be calibrated with external weights).
- Built-in functions for piece counting, percent weighing, formulation and dynamic weight determination.
- Built-in interface of the latest generation (LocalCAN universal interface) allows the attachment of up to 5 peripheral devices. Use of an adapter cable also allows attachment of devices with an RS232C interface.
- Line-independent operation (up to 10 hours) with optional PP-B10 PowerPack.
- Integrated short-form operating instructions to facilitate your daily work.

A brief word concerning standards, guidelines and procedures of quality assurance: Your AG balance conforms with the current standards and guidelines. It supports standard procedures, specifications, work practices and records following **GLP (Good Laboratory Practice)** and **SOP (Standard Operating Procedure)**. The result recording of work procedures and calibration work is very important in this regard; we recommend you purchase the METTLER TOLEDO LC-P45 Printer. Your balance has a CE declaration of conformity and METTLER TOLEDO as the manufacturer has been awarded ISO 9001 and ISO 14001 certification.

Certified versions of the AG balances are also available, please ask your responsible METTLER TOLEDO dealer.

1.3 What you should know about these instructions

These instructions contain orientation aids which facilitate your search for the desired information.

Key designations are enclosed in double angle brackets (e.g. «**On/Off**» or «»).



The keys of your AG balance have multiple assignments: The first function of any key (e.g. "1/10d") is available by pressing it briefly, whereas the second function (e.g. "Cal.") can be called up by pressing and holding the key.



This symbol indicates pressing the key briefly



This symbol indicates pressing and holding the key (approx. 2 seconds).

long

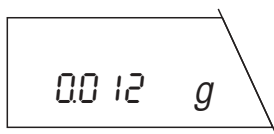

This representation symbolizes the current display of your balance.

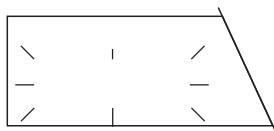

This representation symbolizes a flashing element in the display of your balance.



These symbols indicate safety and hazard instructions which must be complied with. Noncompliance with such instructions can lead to personal injuries to the user, damage to the balance or other tangibles or malfunctions could result.

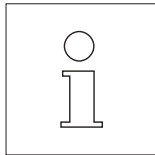

This symbol indicates additional information and directions which facilitate the handling of your balance and contribute to proper and economical use.

1.4 Safety has priority

Please note the following directions for safe and problem-free operation of your AG balance.



Read through these operating instructions carefully, even if you already have experience with METTLER TOLEDO balances.

It is essential to follow the instructions in Section 2 when putting your new balance into operation.

Use AG balances only in closed rooms.

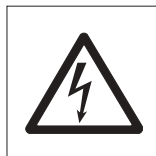

The AG may be not operated in hazardous areas and must be connected only to a receptacle-outlet with grounding connection.

Use only the AC adapter supplied with your AG balance and ensure that the voltage value printed on it matches the local line voltage.

Use only optional equipment and peripherals supplied by METTLER TOLEDO with your AG balance; these have been designed to work optimally with your balance.

Your AG balance has a rugged construction, but it is still a precision instrument. If you treat it with the appropriate care, it will thank you with many years of trouble-free operation.

Never operate the keypad of your balance with sharp objects.

Never open the balance, it does not contain any parts that can be maintained, repaired or changed by the user. Should you have problems with your balance on the odd occasion, please inform your responsible METTLER TOLEDO dealer.

Defective instruments must be disposed of in accordance with applicable customer and national regulations.

2 Putting the balance into operation

In this Section you will learn how to unpack your new balance, set it up and prepare it for operation. On completion of the steps described in this Section, your balance is ready for operation.

2.1 Unpacking and checking the standard equipment

Before you set up your new balance and put it into operation, you should check whether you have received all accessories that are part of the standard equipment of your balance.

Open the packaging carton, hold the fabric band and pull the balance together with the protective foam cushionings out of the carton. Remove the fabric band and the two protective foam cushionings.

First open the large box with the accessories and check the shipment for completeness. You should find the following parts, which are part of the standard equipment, in the accessories box:

- Operating instructions incl. sticker with short-form operating instructions
- AC adapter
- Holder for AC adapter
- Power cable
- Weighing chamber plate
- Weighing pan
- Draft shield element for weighing pan (AG135, AG285 only)
- Cleaning brush

Remove the balance and the small box from the plastic bag. The small box contains the protective cover for the keypad and display.

Keep all parts of the packaging in a safe place. This packaging guarantees the best possible protection for the transport of your balance.

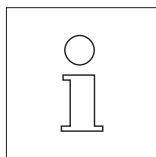

Remove the adhesive tapes from the draft shield doors.

Check the balance for any damage. Check that all draft shield doors are in perfect condition and run smoothly. Report any faults to your responsible METTLER TOLEDO dealer immediately.

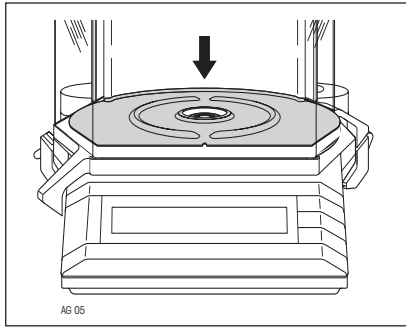

Insert the weighing chamber plate (with the straight edge forward and the raised parts pointing upward) in the weighing chamber. Press the plate down as far as it will go.

Important: A recess below the weighing chamber plate has space for a software cassette, protected by a transparent cover.

If your balance should be specially equipped for density determination or differential weighing (see Optional Section 7.3), you can insert the appropriate cassette at this position (for this operation, the balance must be disconnected from the power supply).

Without a cassette, the balance runs with the standard software, as soon as a cassette is inserted, the balance automatically adopts this software.

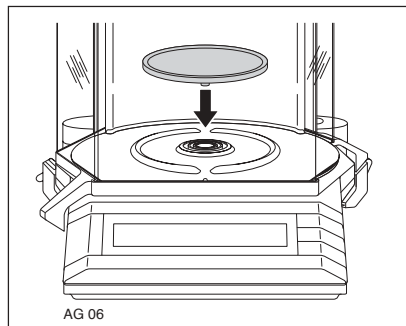

Mount the weighing pan.

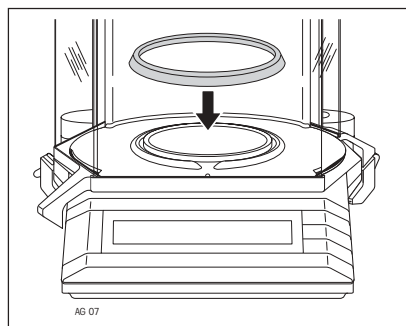

For AG135, AG285 only: Install the draft shield element.

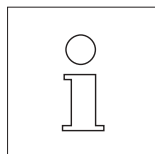

If your balance has the optional inner draft shield, install this in the weighing chamber. In this case, consult the separate installation instructions enclosed with the inner draft shield.

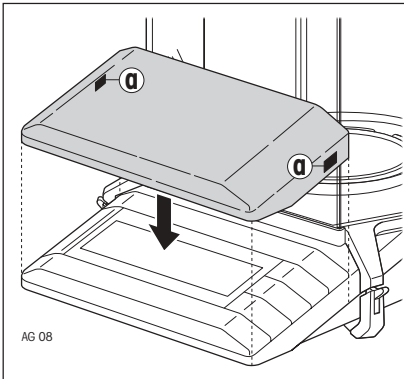

If you operate your balance in surroundings which are likely to contaminate it, we advise you to mount the transparent protective cover supplied for the keypad and the display:

Remove the protective films of the pieces of adhesive tape (a) and place the protective cover on the keypad. Press the two pieces of adhesive tape against the terminal housing to fix the protective cover.

2.2 Selecting or changing the location

Your balance is a precision instrument. Choose an optimum location and it will thank you with high accuracy and dependability.

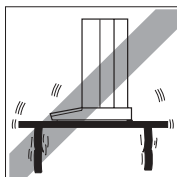

Firm, vibration-free position as level as possible

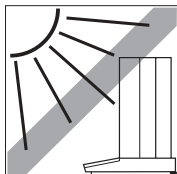

No direct sunlight

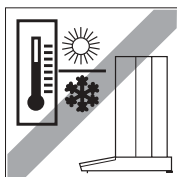

No extreme temperature fluctuations

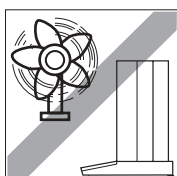

No excessive drafts (powerful air conditioning systems or fume hoods can also cause drafts)

For further instructions regarding an optimum location, please consult Section 6.1.

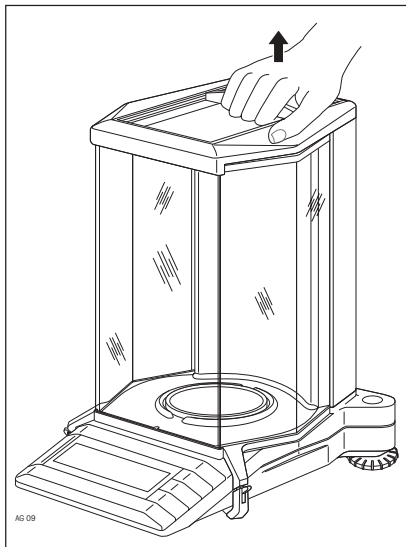

Carry the balance to its selected location. Open the top draft shield door and hold the balance by the rear guide frame, or ...

... hold the balance at the front beneath the display and at the back under the balance housing to transport it.

2.3 Leveling the balance

To assurance reproducible weighing results at all times, the balance must be exactly horizontal. To compensate any minor unevenness in its location, the balance can be leveled.

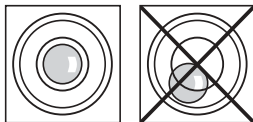

Turn the two leveling feet at the rear of the balance housing until the air bubble is in the center of the leveling control.

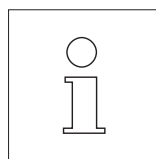

The balance should be releveled after every location change.

If you have purchased an optional antitheft device for your AG balance, mount this as described in the instructions enclosed with the antitheft device.

2.4 Power supply

For attachment to the power supply, an AC adapter designed to operate with your local line voltage supply is enclosed with your balance. Electrostatic charges are dissipated using a high-resistance ground connection.

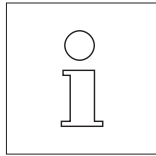

Your AG balance can also be operated independently of the power supply with the optional rechargeable battery "PP-B10 PowerPack".



Check that the voltage printed on the AC adapter matches your local line voltage. If this is not the case, on no account connect the AC adapter to the power supply but contact your responsible METTLER TOLEDO dealer.

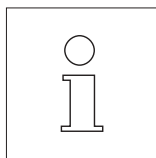

Your balance has two AC adapters with the national power cable available:
 115 V, -20 % +15 %, 50/60 Hz
 230 V, -20 % +15 %, 50/60 Hz

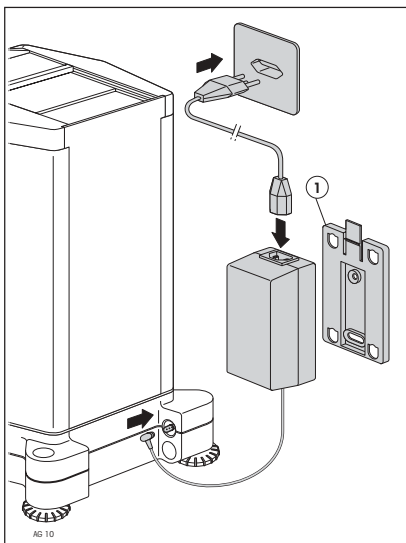

Should you wish to use the holder (1) supplied for the AC adapter: Attach the holder to a suitable, sufficiently stable area using two screws (e.g. to the wall or the underside of a bench top). Press the AC adapter in the holder.

Note

The AC adapter can be removed from the holder by pressing the projecting tab.

Connect the AC adapter to the connection socket of your balance and to the power supply.



Ensure that the AC adapter can never come into contact with liquids!

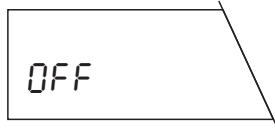

The balance now performs a self-test in which all display segments light up. "OFF" then appears in the display ("OFF" shows that the balance was disconnected from the power supply).

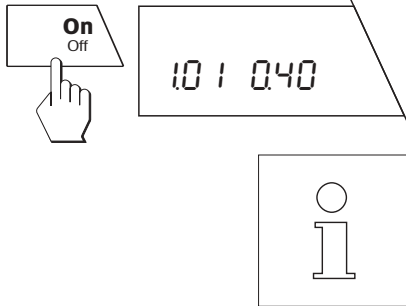

Press the «**On/Off**» key. The display shows the installed software version briefly and the normal weight display then appears.

Allow your balance to warm up for 30 minutes. The balance adapts itself to the ambient conditions during this time.

2.5 Affixing short-form operating instructions

A separate set of short-form operating instructions in the form of a sticker is enclosed with your balance. These short-form operating instructions show you the most important steps in condensed form for operation of your balance.

Your balance has a slide at its rear for attachment of the short-form operating instructions so that you have them available at all times.

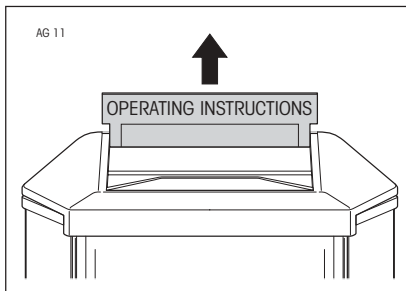

Pull the slide for the short-form operating instructions upward out of the balance (you must overcome a slight resistance which serves as a stop). Place the slide on a flat surface.

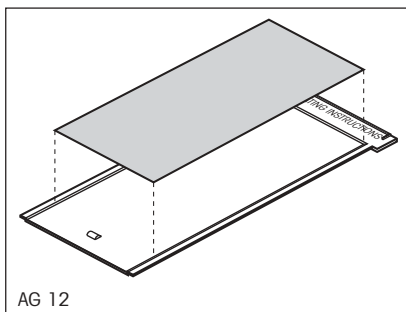

Carefully remove the sticker with the short-form operating instructions from its backing film and stick the short-form operating instructions to the slide.

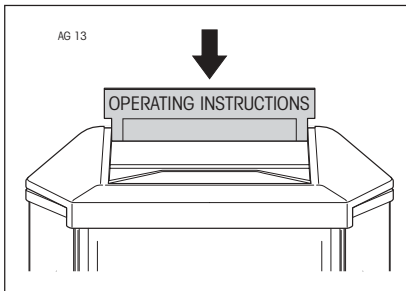

Place the slide in its guide slot on the balance and push it down as far as it will go.

When needed, you can pull up the slide with the short-form operating instructions to give you an immediate overview of the most important functions.

2.6 Calibrating the balance

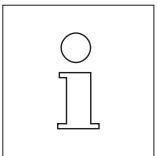

Calibration (i.e. adjustment to the acceleration due to gravity) is necessary on first-time startup and after every location change. You should also calibrate the balance at regular intervals during weighing operation to obtain precise results. If you work according to **GLP** (**G**ood **L**aboratory **P**ractice) and **SOP** (**S**tandard **O**perating **P**rocedure), observe the specified intervals for calibration.

With AG balances you have various possibilities for adjusting (calibrating) or checking the balance. You have a choice between

- Adjustment (calibration) or checking the balance,
- internal or external weights,
- automatic or manual initiation of the adjustment operation
- Adjustment (calibration) blocked (not possible with certified balances).

The factory setting is fully automatic adjustment (calibration) **FACT** (**F**ully **A**utomatic **C**alibration **T**echnology) with the internal weight. In this setting, you have no need worry about adjusting (calibrating) your balance.

The balance adjusts itself automatically

- after the warm-up phase on connection to the power supply,
- when a change in the ambient conditions, e.g. the temperature could lead to a noticeable deviation in the measurement.

```
--BALANCE  CALIBRATION--  
03.02.97      11:23:34  
  
METTLER TOLEDO  
Balance  
Type:          AG204DR  
SNR:           23001222  
  
Int. calibration done  
  
Signature:  
  
.....  
-----  END  -----
```

If your balance is attached to a printer, the adjustment (calibration) is automatically printed out in conformance with GLP. The record opposite is a specimen printed out with the METTLER TOLEDO LC-P45 Printer.

3 Weighing made simple

This Section explains how you can match the draft shield to your needs, how you can perform simple weighings, how you can speed up the weighing process and how the weighing result can be printed out and data transferred.

3.1 Switching the balance on and off

In the factory, your balance is set so that it automatically switches to the weighing mode when you load a weight in the standby mode.



To **switch on the balance**, press the «**On/Off**» key **briefly**. As soon as the normal weight display appears, your balance is ready for weighing.

Note: In Section 4.14 you will learn how a display test, in which all segments of the balance light up briefly, can be performed on switching on.

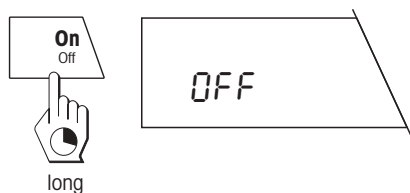

To **switch off the balance**, press and **hold** the «**On/Off**» key until the message “OFF” appears in the display.

After switching off, the balance is in the standby mode. If you wish to perform a weighing, all you need do is place the weighing sample on the pan and your balance will display the result immediately. There is no need to switch it on using the «**On/Off**» key (see also Section 4.14). This function is not available with certified balances.

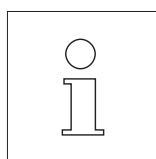

As the balance needs no warm-up time when switching from the standby mode and is thus immediately ready for weighing, we advise you not to disconnect the instrument from the power supply but to switch it off only by using the «**On/Off**» key. This also assures that the balance is always in thermal equilibrium.

3.2 Adapting the draft shield

The draft shield of your balance can be easily adapted to your specific weighing needs. The coupling elements integrated in the lower part of the door handles can be used for any combination of the left and right door of the draft shield. Your balance can thus be configured individually for right- and left-handers and for different types of loading.

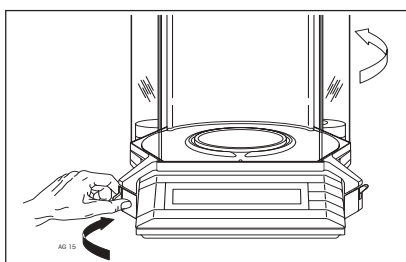
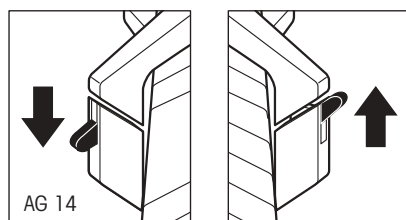

If you operate the draft shield with one hand and wish to load the balance using the other, push **one coupling element downward and the other upward**.

Example: If you operate the draft shield with your left hand and wish to load the balance with your right (this corresponds to the normal mode of operation for right-handers), push the right coupling element upward and the left downward.

You can now open and close the right draft shield door with the bottom part of the left door handle.

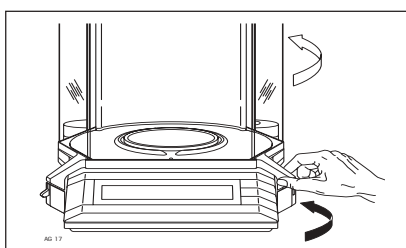
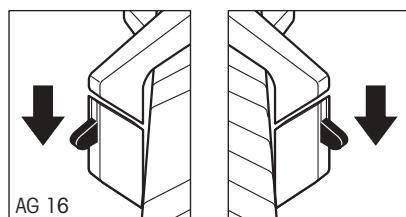

If you wish to open and close both draft shield doors individually, push **both coupling elements to the bottom position**. Owing to the space requirements for insertion of the doors, only one of the doors can be opened fully at any one time.

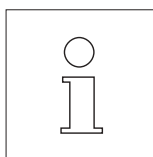

To load the balance with **small weighing samples**, we advise you to open only one of the two side doors at any one time. Your balance will then operate faster as the disturbance due to air currents is less than when the draft shield is fully open.

3.3 Taring the balance

The weight of any weight container can be “tared” at a keystroke and the display set to zero. The taring range encompasses the entire weighing range of your balance.

If you wish to tare a container, place this on the weighing pan.

Close all draft shield doors.



Briefly press the $\leftarrow \rightarrow 0/T \leftarrow$ key to start the taring process.

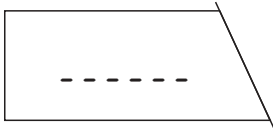

Taring runs automatically. If you tare the balance when it is unstable, the taring operation will be shown in the display by horizontal segments.

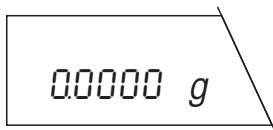

On completion of taring, the zero display appears and your balance is ready for weighing.

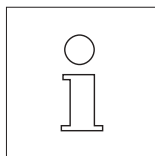

By pressing the $\leftarrow \rightarrow 0/T \leftarrow$ key again in the unstable (not yet tared) condition, you can abort taring.

3.4 Performing a simple weighing

How you perform a simple weighing is described here only for the sake of completeness as this operation comprises only two steps.

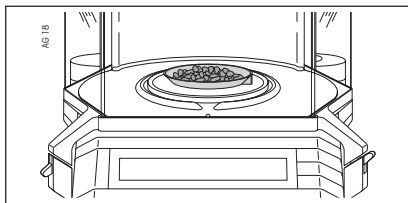

After you have performed taring, open the draft shield, place the weighing sample on the pan and close the draft shield.

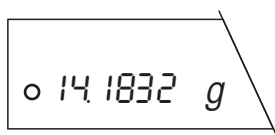

Wait until the circular symbol of the stability detector fades. When the symbol has faded, the weighing result is stable.

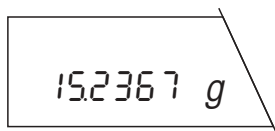

Now read off the displayed weight.

3.5 Faster weighing with lower readability

Your balance allows you to lower the readability (number of decimal places) at any time and thus speed up the weighing process.

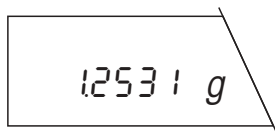

The balance operates with **normal readability and speed**.

Note: The number of decimal places displayed with normal readability depends on the balance model, the weighing range and the weighing unit selected.

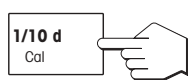

Briefly press the «**1/10d**» key and ...

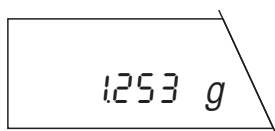

... the balance operates with **lower readability** (one decimal place less), but displays the result considerably **faster**. Press the «**1/10d**» key again to return to normal readability.

3.6 Switching weighing units

Your balance can display the weighing result in two different weighing units. Please see Sections 4.10 and 4.11 for how to preselect the two weighing units.

You can switch between the two weighing units by simply pressing a key.

Note: With certified balances, the weighing unit 1 setting is fixed and can not be changed.

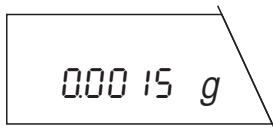

The balance displays the result in **weighing unit 1**.

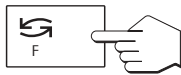

Briefly press the «» key.

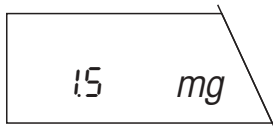

The balance displays the result in **weighing unit 2**. Press the «» key again to return to weighing unit 1.

Note: Should another unit (e.g. “%” or “PCS”) be displayed when switching between the two weighing units, you have preselected a function in the menu. You will find further information on the functions in Sections 4.6 and 5.1 through 5.4.

Section 8.2 contains a table of the conversion factors between the different weighing units.

3.7 The AG135, AG285 dual-range balance

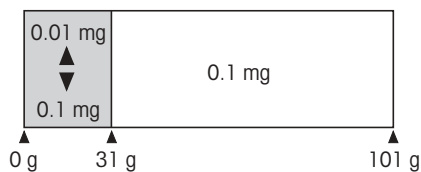

If you have an AG135 or AG285 balance, you have a dual-range balance. These models also have a fine (semimicro) range from 0 to 31 or 81 grams, respectively. In this fine range the balance shows the result with a higher resolution, i.e. with one decimal place more. In contrast to the DeltaRange® balances, this fine range can not be moved, i.e. it always starts at 0 and ends always at 31 or 81 grams.



The AG135 and AG285 automatically operate in the normal weighing range when first switched on.

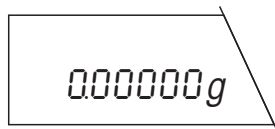

By briefly pressing the «1/10d» key, you can switch to the fine range.

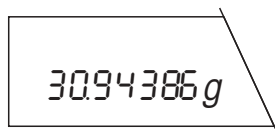

The fine range remains active up to a weight of 31 or 81 grams.

Note

Below 31 or 81 grams, you can switch between the fine range and the normal weighing range at any time by pressing the «1/10d» key.

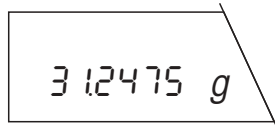

If the weight is greater than 31 or 81 grams, the balance quits the fine range and displays in the normal weighing range.

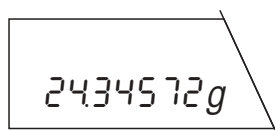

If you remove or decrease the weight following a weighing in the range above 31 or 81 grams, the balance automatically returns to the fine range.

3.8 DeltaRange® balances with movable fine range

METTLER TOLEDO DeltaRange® balances have a **movable** fine range with a 10 times greater readability. An additional decimal place always appears in the display in this fine range. Thanks to the DeltaRange function, you have the possibility to weigh small amounts of samples into heavy weighing containers.

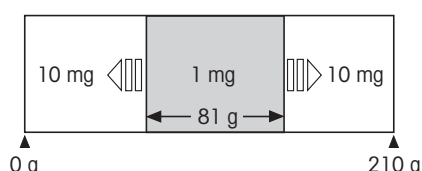

The illustration opposite shows the principle of the movable fine range in which one additional decimal place is displayed (in this example, the movable fine range comprises 81 grams).

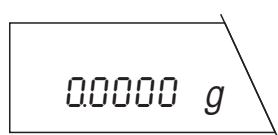

After switching on, DeltaRange® balances operate in the fine range as standard.

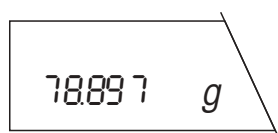

If the fine range is exceeded in the display, the balance display automatically switches to the lower readability.



However, the fine range can be called up at any time by retaring the balance.

3.9 Printing out weighing result and transferring data

If your balance is connected to a printer via the LocalCAN universal interface, you can transfer current weighing results, identifications and other data to the attached device at a keystroke.

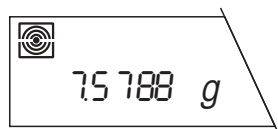
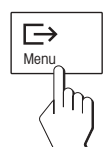

Briefly press the $\llcorner \rightarrow$ key. As soon as the weighing result is stable, the status indicator of the repeatability fades and the result is transferred to the attached device.

You will find further information on the attachment of a printer in Section 6.4 and in the documentation accompanying your printer.

4 The menu

4.1 What is the menu?

The menu allows you to adapt your balance to your specific weighing needs. You can use the menu to change the settings of your balance and activate functions.

The menu contains **14 different menu options**, each of which offers various selection possibilities.

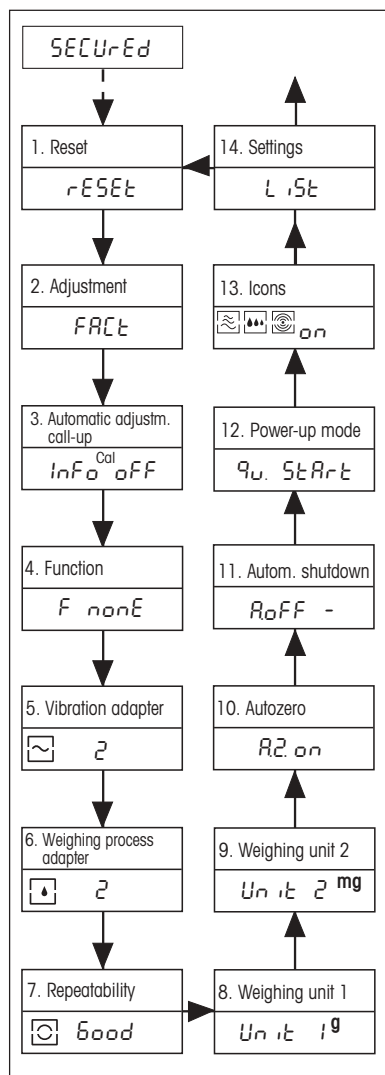

- 1. Reset:** Call-up of the factory setting.
- 2. Calibration:** Presettings for the type and test of the calibration.
- 3. Automatic adjustment call-up ^{1), 3)}:** Switch adjustment call-up to the display on or off.
- 4. Function ²⁾:** Preselection of the function which should be available at a keystroke in weighing operation.
- 5. Vibration adapter:** Matching the balance to the ambient conditions.
- 6. Weighing process adapter:** Matching the balance to different types of weighing.
- 7. Repeatability:** Selection of the repeatability of the weighing results.
- 8. Weighing unit 1 ¹⁾:** Definition of the 1st weighing unit in which the balance should show the result.
- 9. Weighing unit 2 ²⁾:** Definition of the 2nd weighing unit in which the balance should show the result.
- 10. Zero-point correction:** Switch automatic zero-point correction (Auto Zero) on or off.
- 11. Automatic shutdown:** Preselection of the time after which the balance should be switched off automatically.
- 12. Switch-on mode ¹⁾:** Start without or with display test.
- 13. Icons:** On or off switching of the icons.
- 14. Settings:** Saving or printing out all menu settings.

¹⁾ With certified balances, these menu options have a fixed setting and can not be changed.

²⁾ With certified balances, only those weighing units/functions allowed by national weights and measures legislation can be selected.

³⁾ This menu option is shown only if "FACT" or "CAL OFF" has **not** been selected in menu option 2.

Note: You will find an overview diagram of the entire menu with all setting options in Section 8.1.

4.2 Menu operation

In the Section you will learn how to work with the menu. You will find information on the individual menu options and the available settings in the following Sections.

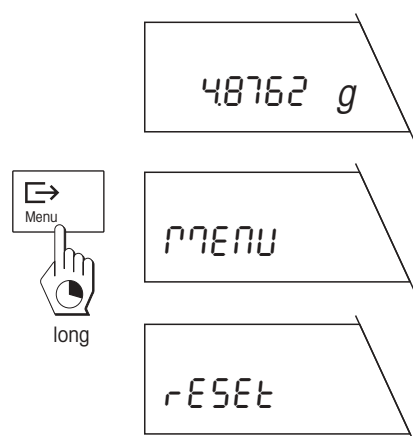

How to switch from the weighing mode to the menu

The balance operates in the normal weighing mode.

Press and hold the «**Menu**» key until the balance switches to the menu.

After release of the «**Menu**» key, the balance shows the first menu option (“Reset”) directly with the current setting.

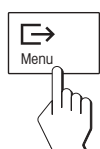

How to select the menu options

Briefly press the «**Menu**» key.

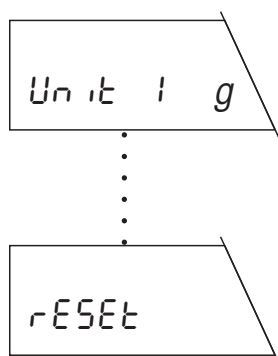

The next menu option appears in the display. Each time the «**Menu**» key is pressed, the balance switches to the following menu option.

After the fourteenth and last menu option (“Settings”), the first menu option (“Reset”) is again shown.

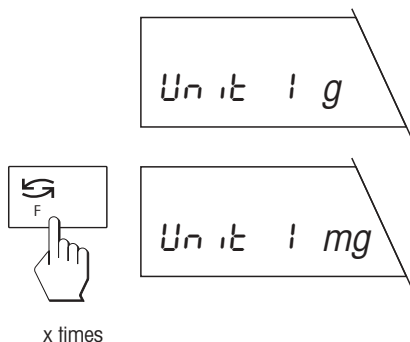

How to select the desired setting in a menu option

Briefly press the «**F**» key. The display shows the next setting available in the selected menu option. Each time the «**F**» key is pressed, the balance switches to the next setting. After the last setting, the first is shown again.

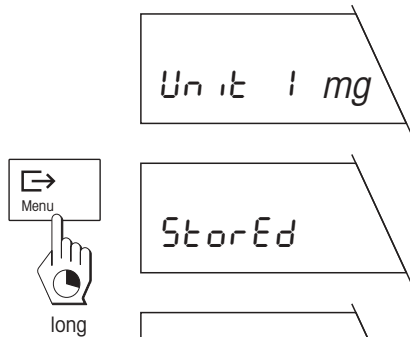

How to save your settings and quit the menu

After you have made all settings in the individual menu options, press and hold the «**Menu**» key until the balance returns to the weighing mode.

Before the normal weighing result display appears, the balance briefly confirms storage of the settings.

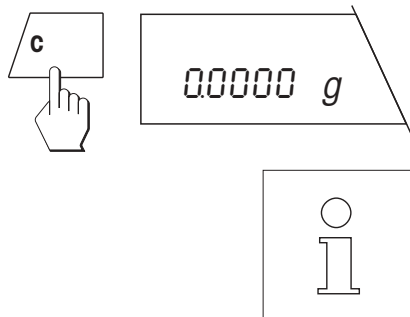

How to quit the menu without saving your settings

By briefly pressing the «**C**» key, you can return to the weighing mode at any time **without changing the stored settings**.

If you do not press a key for 45 seconds, the balance **automatically** returns to the weighing mode. Changes you have made in the menu will **not be stored!**

4.3 Reset

In this menu option you have the possibility to reset all menu settings to the factory setting.

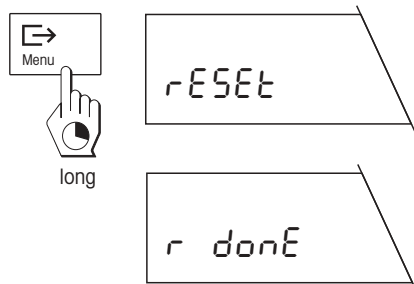

Resetting settings to factory setting

If you select this option and then save and quit the menu, all menu settings are reset to the values set in the factory.

Before the return to the weighing mode, the resetting is briefly confirmed in the display.

4.4 Selection of the calibration and test function

Your balance can be calibrated with internal or external weights. Further, the balance can also be checked by a test with internal or external weights. If you have attached a printer to your balance, the data of the calibration and results of the test are printed out following GLP recommendations.

The following settings are available:

Fully automatic internal adjustment (calibration) FACT (Fully Automatic Calibration Technology)

This is the factory setting. The balance adjusts (calibrates) itself fully automatically. With certified versions of the balances, this function is always active even if a different setting has been preselected in the menu; FACT does thus not appear at all here.

- after the warm-up phase following connection to the power supply,
- when a change in the ambient conditions, e.g. the temperature could lead to a noticeable measurement deviation.

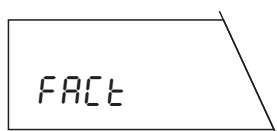

No adjustment function preselected.

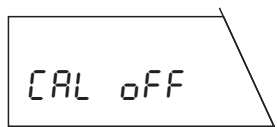

Internal calibration

The balance is calibrated at a keystroke with the built-in weight.

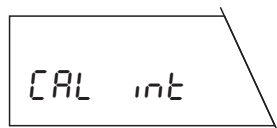

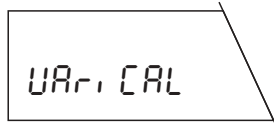

Calibration with external weights (VariCal)

The balance is calibrated with a selectable* external weight.

* With certified versions of the balances, the weight is preallocated and can not be changed.

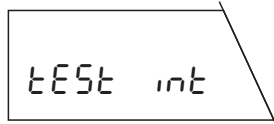

Test of the balance with internal weight

In this setting the accuracy test of the balance is performed with the internal weight.

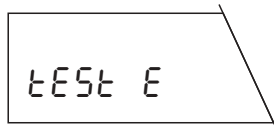

Test of the balance with external weights

The accuracy of the balance can be checked with any external weight.

You will find information on how to perform the calibration and test function in Sections 2.6, 5.6 and 5.7.

4.5 Switching automatic adjustment call-up on or off

In this menu option you can switch the call-up of the automatic adjustment or test on or off.

Note: If you have set «FACT» in the menu option Adjustment (calibration), the automatic adjustment call-up is always active and will thus be skipped in the menu. It becomes active again as soon as «FACT» is switched off.

The following settings are available:

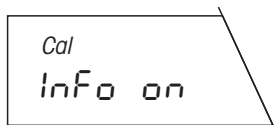

Automatic adjustment or test call-up switched on

This is the **factory setting**. The balance uses a flashing «Cal» in the display to prompt you to adjust (calibrate) or test it with the internal weight or external weights.

The call-up is initiated by, e.g. ambient temperature changes.

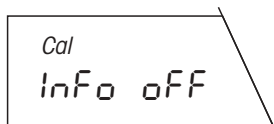

Automatic adjustment or test call-up switched off

The automatic adjustment or test call-up is switched off.

Note

With certified balances, the automatic adjustment or test call-up can not be switched off.

4.6 Preselecting a function

In this menu option you can preselect a function which you will then have available in the weighing mode at a keystroke.

The following functions are available.

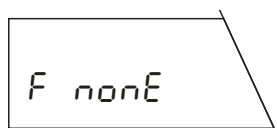

No function preselected

You have no function available in the weighing mode (**factory setting**).

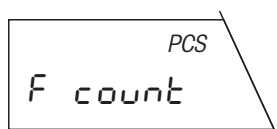

Piece counting

Your balance counts the pieces you add to or remove from the weighing container.



Percent weighing

Your balance allows you to weigh in to a preset value or determines percentage weight deviations.

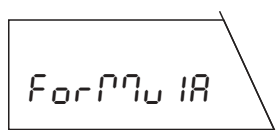

Simple formulation

The formulation function allows you to weigh in up to 255 individual components, store their weights and totalize. If your balance is attached to a printer, all individual weights and the total weight of all components are printed out. Further, up to 99 weighing containers can be tared. Your balance can store and print out the total weight of all weighing containers.

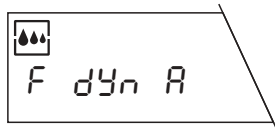

Dynamic weighing with automatic start

Your balance determines an average weighing result over a preset time interval. This setting is suitable for unstable weighing samples (e.g. animals). With this setting, the dynamic weighing starts automatically.

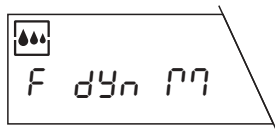

Dynamic weighing with manual start

Analogous to dynamic weighing with automatic start, but the weighing cycle must be started manually.

You will find information on working with the functions in Section 5.

4.7 Setting the vibration adapter

The vibration adapter can be used to match your balance to the ambient conditions (vibrations, drafts at location).

The following settings are available:

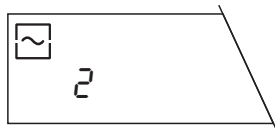

Setting for normal ambient conditions

This is the **factory setting**. The balance operates at moderate speed.

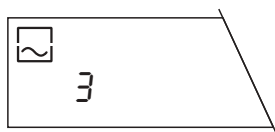

Setting for unstable surroundings

The filter setting of the balance is higher than in the factory setting, but the balance is less sensitive to external influences.

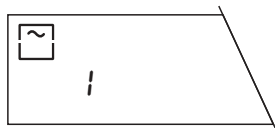

Setting for virtually disturbance-free, stable surroundings

The filter setting of the balance is lower than in the factory setting, but the balance is more sensitive to external influences.

4.8 Setting the weighing process adapter

The weighing process adapter can be used to match your balance to the different types of weighing (absolute weighing, fine dispensing, etc.).

The following settings are available:

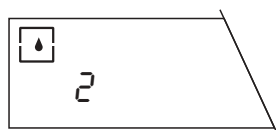

Universal setting

This is the **factory setting**, it is suitable for all types of weighing. The display always corresponds to the current weight.

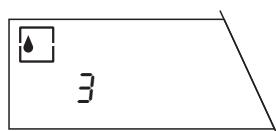

Absolute weighing

This setting is suitable for checkweighing and for the weight determination of samples.

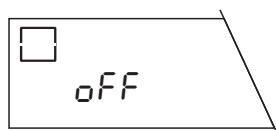

Special applications

In this setting there is a fixed time relationship between the displayed weight value and the weight change.

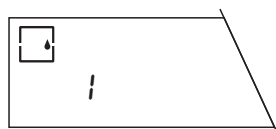

Fine dispensing

This setting is suitable for the weighing-in of fine powder, small amounts of liquids, etc.

4.9 Selecting the repeatability

The circular symbol of the stability detector can be found in the bottom left corner of the display. As soon as the weighing result is within preset limits for a certain period of time, the weighing result is considered stable and the symbol for the stability detector fades. You can use the setting of the repeatability ("Repro-Set") to determine the time period during which the result must lie within the limits for it to be considered stable. The better the repeatability, the longer the weighing operation.

The following settings are available:

Good repeatability

Fast release of the weight display as stable, this is the **factory setting**.

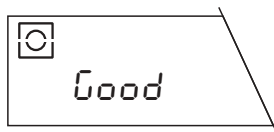

Very good repeatability

Slower release of the weight display as stable.

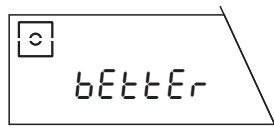

Best possible repeatability

Weight display not released as stable until several seconds have elapsed without change.



Normal repeatability

The weight display is released very quickly as stable, in other words: The display of the stability detector fades very fast.



4.10 Selecting weighing unit 1

In this menu option you determine the **unit*** in which the weighing result should be displayed.

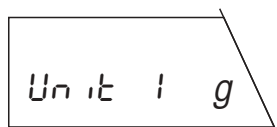

The following units* are available:

Display	Designation	Comments
g	gram	factory setting
oz	ounce	not available with AG135, AG285
ozt	Troy ounce	not available with AG135, AG285
GN	grain	
dwt	pennyweight	
ct	carat	
mg	milligram	
mo	momme	
m	mesghal	

You will find a table with the conversion factors for the different units in Section 8.2 of these operating instructions.

* With certified balances, the weighing unit 1 has the fixed setting and can not be changed.

4.11 Selecting weighing unit 2

In this menu option you determine the **additional unit*** in which the weighing result should be displayed.

Unit 2 mg

The following units* are available:

Display	Designation	Comments
mg	milligram	factory setting
mo	momme	
m	mesghal	
H tl	Hong Kong taels	not available with AG135, AG285
S tl	Singapore taels	not available with AG135, AG285
t tl	Taiwan taels	not available with AG135, AG285
g	gram	
oz	ounce	not available with AG135, AG285
ozt	Troy ounce	not available with AG135, AG285
GN	grain	
dwt	pennyweight	
ct	carat	

You will find a table with the conversion factors for the different units in Section 8.2 of these operating instructions.

* With certified versions of the balances, only the weighing units approved by the national weights and measures legislation may be selected.

4.12 Switching the automatic zero-point correction (Auto Zero) on or off

In this menu option you can switch the automatic zero-point correction on or off. If switched on (factory setting), the zero point is automatically corrected for drift or contamination of the weighing pan.

The following settings are available:

Auto Zero switched on

This is the **factory setting**. The zero point is automatically corrected.

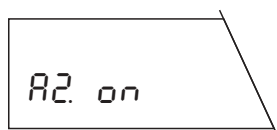

Auto Zero switched off

The zero point is not automatically corrected. This setting is advantageous for special applications (e.g. evaporation measurements).



4.13 Preselecting the automatic shutdown

If you operate your balance with the optional PP-B10 PowerPack, you can extend the line-independent operating time of the balance appreciably if you activate the automatic shutdown. When the automatic shutdown is active, the balance switches itself off automatically after a preselected time (time elapsed after the last operation). When operated from the power supply, the balance is switched to the standby mode after elapse of the shutdown time.

The following settings are available:

No automatic shutdown

The automatic shutdown is deactivated (**factory setting**).

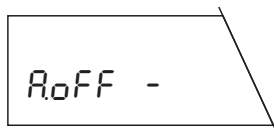

Automatic shutdown after 2 minutes

If the balance has not been operated for 2 minutes, it switches itself off automatically.

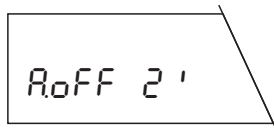

Automatic shutdown after 5 minutes

If the balance has not been operated for 5 minutes, it switches itself off automatically.

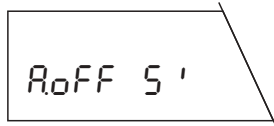

Automatic shutdown after 10 minutes

If the balance has not been operated for 10 minutes, it switches itself off automatically.



4.14 Selecting the switch-on mode

You can set your balance so that it starts immediately from standby when a weight is placed on the pan or so that it must be switched on with the «**On/Off**» key and then performs a display test.

The following settings are available:

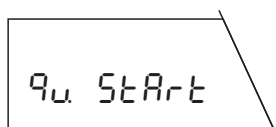

Quickstart*

This is the **factory setting**. The balance can be started directly from standby and is immediately ready for weighing. You can place the weight on the pan in the standby mode and the balance immediately displays the weighing result.

*Quickstart is not possible with certified balances.

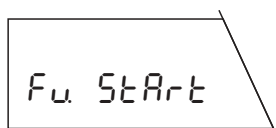

Start with display test

You must switch on the balance with the «**On/Off**» key. After the balance has been switched on, it performs a display test during which all display segments light up briefly. On completion of the test, the balance is ready for weighing.

Note: If the balance has been separated from the power supply, it always performs a display test after switching on, even if the "Quickstart" setting has been selected.

4.15 Setting display of the icons

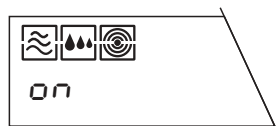

All icons appear in the display.



If desired, you can also switch off the icons. They disappear after about 10 seconds after you have quit the menu or after about 3 min. after the balance has been switched on.

4.16 Printing out or saving menu settings

In this menu option you have the possibility to save all menu settings. You can also print out the current settings of the menu, presupposing your balance is connected to a printer.

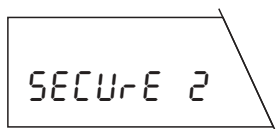
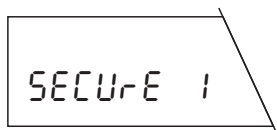
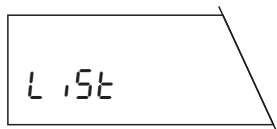

Printing out settings

As soon as you save your settings and quit the menu, all settings specified in the menu will be printed out on the attached printer.

With "Secure 1" you can protect the menu settings against inadvertent changes.

With "Secure 2" you can protect both the menu settings and also the  key, which triggers the adjustment function or lowers the readability of the display, against inadvertent changes.

Note

If the adjustment function "FACT" is set in the menu option, the AG balance also automatically performs an internal adjustment in the setting "secure 2".

Canceling secure function

If "secure" is selected in the menu, "secure" appears when it is reentered (initiated by the menu key). If you do not press the  key for more than 3 seconds, the balance automatically returns to the weighing mode (menu remains blocked).

After the  key has been pressed, "Open" appears. Confirm this within 3 seconds by pressing and holding the menu key, entry into the menu is then possible again (menu open).

Note

The release applies to "SECURE 1" and "SECURE 2".

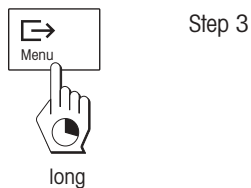
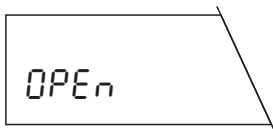
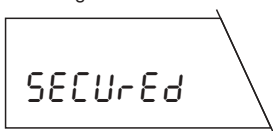
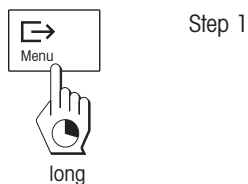

5 Special applications and functions

Your balance can do more than just weigh. Built-in applications and functions expand its possibilities and facilitate your daily work. You will learn these applications and functions in the following Sections.

5.1 Piece counting

Piece counting presupposes that you have preselected the "F count" function in the menu (see Section 4.6).

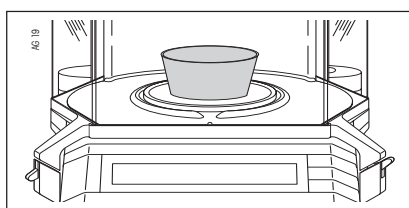

Place the empty container on the pan.



Press the «→0/T←» key to tare the balance.

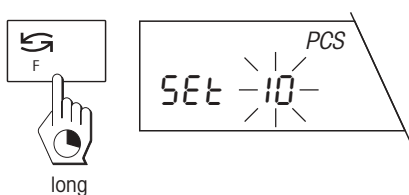

Your balance now needs the weight of a **reference number**. Press and hold the «F» key until you are prompted to load the reference pieces.

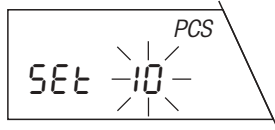

Your balance suggests "10" as the reference number. You can accept this suggestion or select one of the other reference numbers available (20, 30, 50, 100 or 5 pieces) by briefly pressing the «» key.

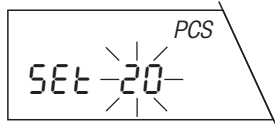
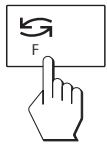

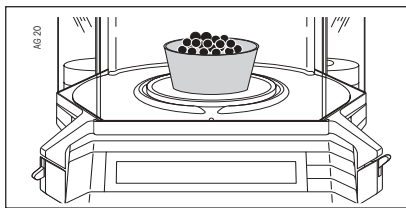

Note

We advise you to choose a reference number as high as possible as the balance determines the average weight per piece and stores it as the reference weight. As it is seldom the case that all pieces weigh exactly the same, the larger the reference number selected, the greater the accuracy of the reference weight.

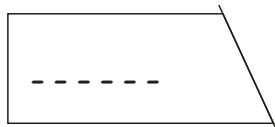
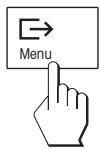

Now place the selected number of reference pieces on the pan.



Then press the «» key briefly. While the horizontal dashes are displayed, your balance is calculating the reference weight.

Note

If you do not press a key for 45 seconds, the balance returns to the weighing mode.

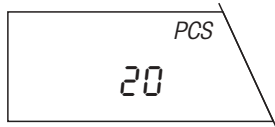

After your balance has determined the piece weight, it displays the correct piece number and is now ready for piece counting.

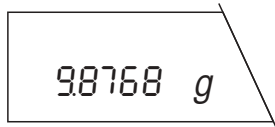

You can use the «» key at any time to switch the display between the piece number display, weighing unit 1 and weighing unit 2.

Note

The current set weight remains stored until it has been redetermined or the power supply to the balance has been interrupted.

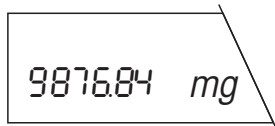
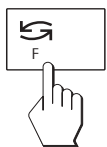

```
---- PIECE COUNTING ----  
APW      0.19990000 g  
Out of:   100 PCS  
  
          100 PCS  
  
Net       20.00 g  
----- END -----
```

If a printer is connected to your balance, the reference weight, the reference piece number, the total piece count as well as the net weight of the total piece count are printed out.

**Note**

If a printer is attached, you can start a new piece counting with the «>0/T<» key.

5.2 Percent weighing

The "Percent weighing" function enables you to weigh in to a preset value (100%) and to determine deviations from this target value.

Percent weighing presupposes that you have preselected the "F 100%" function in the menu (see Section 4.6).

Place the empty container on the balance and tare.

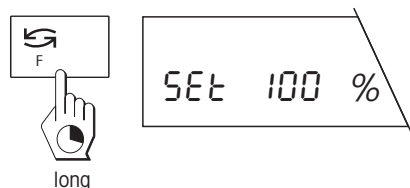

Your balance needs a reference weight corresponding to 100%. Press and hold the «F» key until you are prompted to load the reference weight.

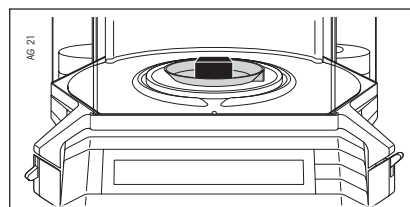

Now place the reference weight on the pan.

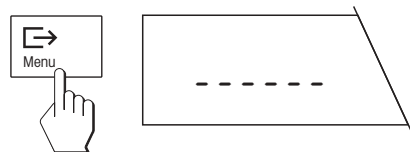

Then press the «Menu» key briefly. While the horizontal dashes are displayed, your balance is calculating the reference weight.

Note

If you do not press a key for 45 seconds, the balance returns to the weighing mode.

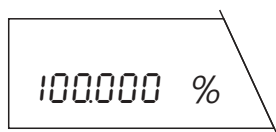

On completion of the weighing-in operation, your balance is ready for percent weighing.

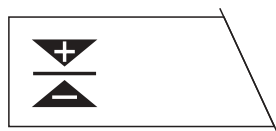

For rapid determination of the preset value (100%), a visual weighing-in aid appears in the display. When the target weight is within $\pm 2.5\%$, both arrows are visible. This tolerance setting is fixed and can be changed only via the interface.

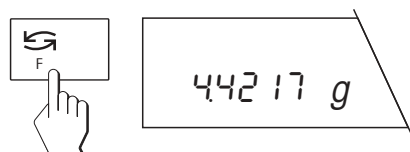

You can use the «F» key at any time to switch the display between the percent display, weighing unit 1 and weighing unit 2.

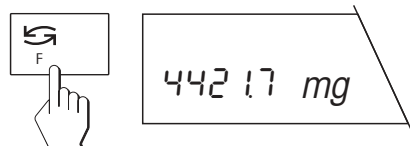

Note

The current set weight remains stored until it has been redetermined or the power supply to the balance has been interrupted.

5.3 Formulation

With the formulation function you can weigh individual weights (components) and totalize them. Your balance processes up to 255 components per formulation operation. Further, you can also tare up to 99 weighing containers per formulation. If your balance is connected to a printer, the entire formulation operation can be recorded.

Formulation presupposes that the "Formula" function has been preselected in the menu (see Section 4.6).

Unload the weighing pan.

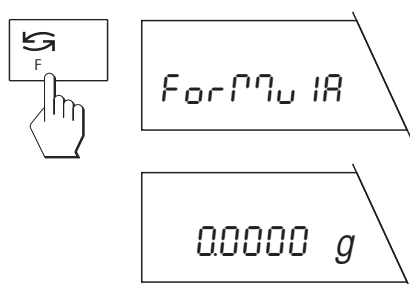

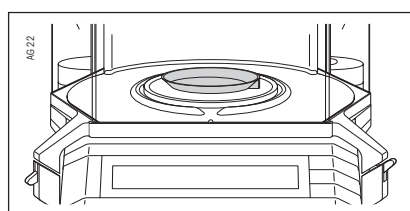

Press the «» key briefly and the display confirms that the formulation function has been activated.

After 2 seconds the normal weight display appears.



If you wish to tare a weighing container, place this on the pan.



Then press the «0/T» key briefly.

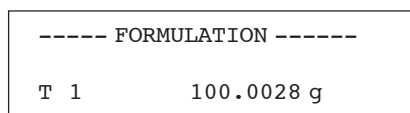

If your balance is connected to a printer, the tare weight is printed out.

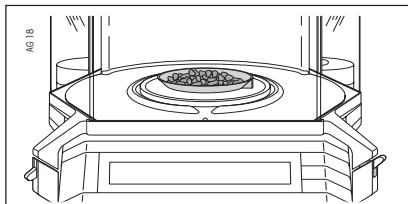

Add the first component to the weighing container.

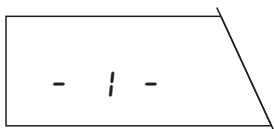
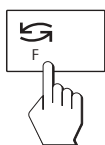

Then press the «» key briefly. The display shows “-1-” briefly to confirm the weighing in of the first component.

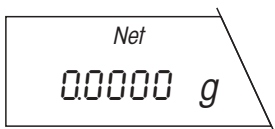



After the first component has been weighed in, the display is reset to zero and the balance is now ready for weighing in of the second component.

----- FORMULATION -----		
T 1		100.0028 g
1	Comp.	12.0000 g

If a printer is attached, the weight of the component will be printed out.

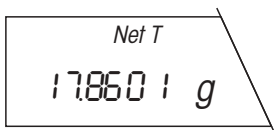
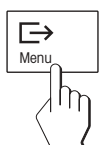
Now weigh in the other components as described above.



As soon as you have weighed in all components, briefly press the «» key. This concludes the formulation operation. The net total weight of all individual components is shown briefly.

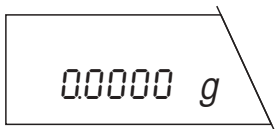

The balance then returns to the normal weighing mode.

The weight memories for tare and net total are now cleared and the balance is ready for the next formulation.

----- FORMULATION -----		
T 1		100.0028 g
1	Comp.	12.0000 g
2	Comp.	2.5600 g
3	Comp.	3.3001 g
T total		100.0028 g
G		117.8629 g
N total		17.8601 g
----- END -----		

If a printer is attached to your balance, a record with the net total weight of all components "N total", the tare weight (weight of the weighing container) "T total" and gross total weight (net total weight of all components and plus tare weight) "G" is printed out.

During the formulation operation you can increase the net total weight to a desired value

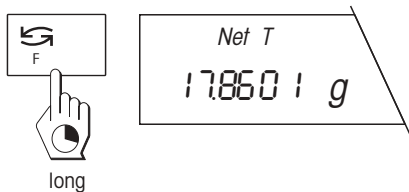

Press and hold the «F» key until the net total weight of all components weighed in so far is displayed.

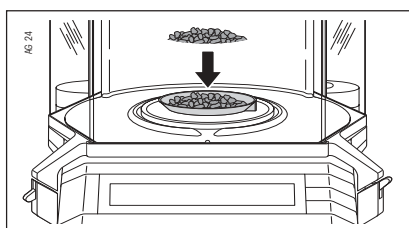

Now add the component to the container until the desired net total weight is reached.

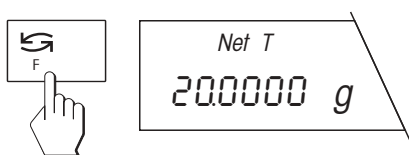

Briefly press the «F» key and the desired weight is confirmed as an additional component.

During the formulation operation you can display the totalized net weight and the number of components weighed in so far at any time

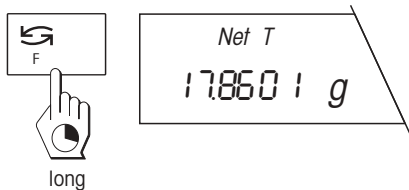

Press and hold the «F» key until the net total weight of all components weighed in so far is displayed.

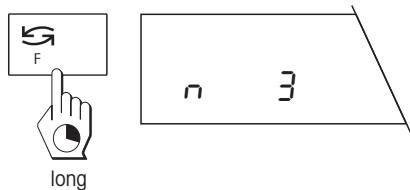

Press and hold the «F» key again until the number "n" of all components weighed in so far is displayed.



Press and hold the «F» key again until the balance switches back to the weight display. You can now weigh in additional components.

During the formulation operation, you can tare additional weighing containers at any time

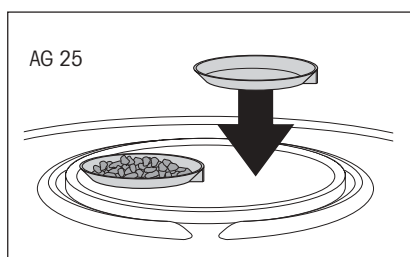

Place the additional weighing container on the weighing pan next to the weighing containers already tared.

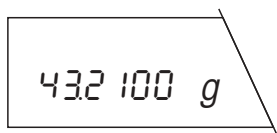

Briefly press the «>0/T<» key. The balance is now tared with the additional weight of the new weighing container. If your balance is connected to a printer, the tare weight of the new container is printed out. You can now weigh in additional components.

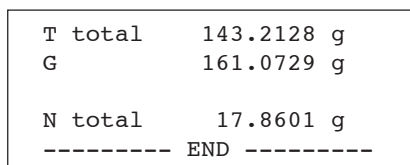
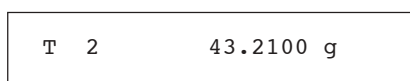

If you print out the results at the end of the formulation operation, all tare weights are totaled and the total weight of all tare containers "T total" is recorded.

5.4 Dynamic weighing of unstable weighing samples

The functions "Dynamic weighing with automatic start" and "Dynamic weighing with manual start" facilitate the weighing of unstable weighing samples (e.g. animals). With this type of weighing, your balance determines the weight over a particular time period and calculates a representative mean value.

Dynamic weighing presupposes that you have preselected the "F dyn A" or "F dyn M" function in the menu (see Section 4.6).

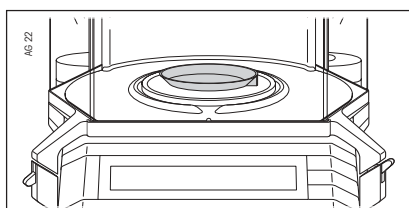

If you work with a weighing container, place it on the weighing pan in the normal weighing mode.

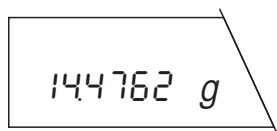

Press the " $\rightarrow 0/T \leftarrow$ " key to tare the balance.

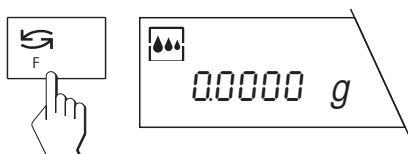

Briefly press the " $\leftarrow \text{F} \rightarrow$ " key. The symbol of the weighing process adapter in the display confirms that dynamic weighing has been activated.

Your balance is set in the factory so that the weight is determined over a period of 3 seconds. You need perform the following 3 steps only if you wish to change this time.

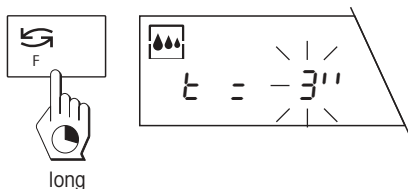

Press and hold the " $\leftarrow \text{F} \rightarrow$ " key until the time display appears.

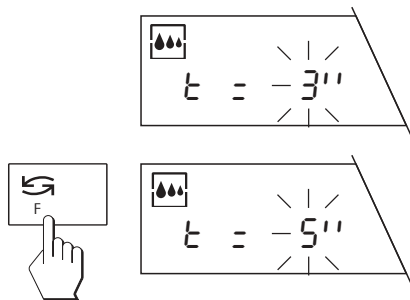

By briefly pressing the «F» key, you can select one of the available time intervals (1, 2, 3, 5, 10 or 20 seconds).

Notes

The more unstable the sample, the longer the time interval to be selected. If you do not press a key for 45 seconds, the balance quits the display without changing the inputted value.

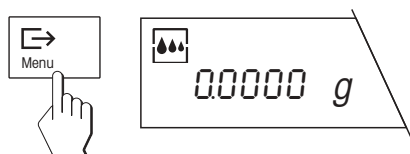

Then press the «Menu» key briefly to confirm the selected time interval.

Your balance is now ready for dynamic weighing.

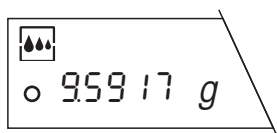

Place the weighing sample on the pan.

If you have selected the "Dynamic weighing with **automatic start**" function in the menu, the weighing starts automatically on relative stability. However, the **weighing sample** must weigh at least **5 grams**.

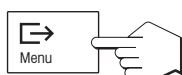

If you have selected the "Dynamic weighing with **manual start**" function in the menu, press the «Menu» key briefly to start the weighing.

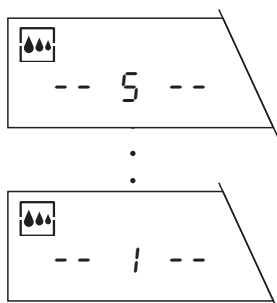

The remaining weighing time (in seconds) is continuously displayed.

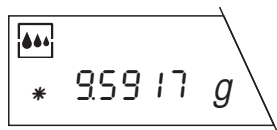

Read off the result after elapse of the weighing time. The asterisk symbol “*” appears in the bottom left corner of the display. This symbol indicates that the value is a mean value of the weighings performed, in other words a **calculated result**. The result remains in the display until the weighing sample is removed. If you wish to weigh the same sample again, press the «» key briefly.

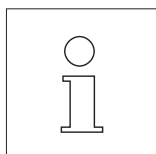

The set weighing time (time interval) remains stored until it is changed or the power supply to the balance is interrupted.

By **briefly pressing** the «» key, you can switch between the normal weighing mode and dynamic weighing at any time.

By **pressing and holding** the «**F**» key, you can display the preselected time interval in the dynamic weighing mode at any time and change it.

5.5 Weighing below the balance

Your AG balance is equipped with a hanger for weighings below the balance.

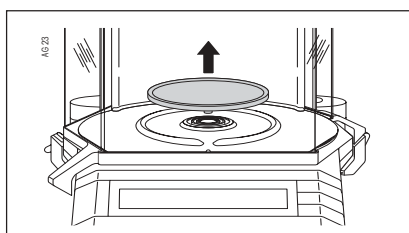

Open the draft shield and remove the weighing pan (with the AG135, AG285 also the draft shield element).

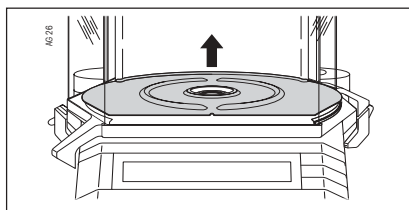

Remove the weighing chamber plate.

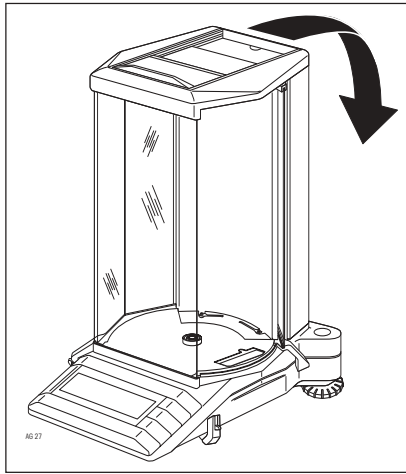

Carefully place the balance on its back.

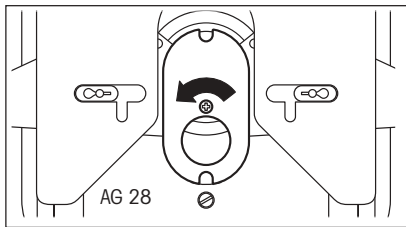

Unscrew the screw of the hanger cover. You need unscrew the screw only until you can turn the cover.

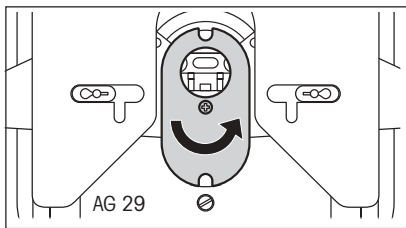

Turn the cover by 180 °C. Center the hole in the cover exactly over the opening in the base of the balance.

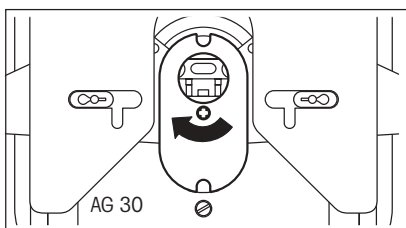

Retighten the screw.

Your balance is now ready for mounting your equipment for below-the-balance weighings.

5.6 Adjustment (calibration) with internal weight

Depending on the setting selected in the menu (see Section 4.4), the adjustment (calibration) can be performed with the built-in, internal weight fully automatically (FACT) or semi-automatically.

Fully automatic internal adjustment (calibration) FACT

Your balance is set in the factory for the fully automatic adjustment with the internal adjustment weight. You are already familiar with this setting from Sections 2.6 and 4.4.

Semi-automatic adjustment (calibration)

If your balance is outside the adjustment tolerance and depending on whether you have set the automatic adjustment call-up in the menu (see Section 4.6), the balance uses a flashing «Cal» in the display to prompt you to adjust (calibrate) with the internal weight at a keystroke. With certified balances, the adjustment (calibration) with the internal weight is performed automatically in accordance with the national weights and measures legislation.

If you wish to adjust your balance with the internal weight, proceed as follows:

Make sure that "FACT" or the "Adjustment (calibration) with internal weight (Cal int)" is selected in the menu (see Section 4.4).

Ensure that the weighing pan is unloaded and close the doors of the draft shield (if used). There is no need to tare the balance before the adjustment (calibration).

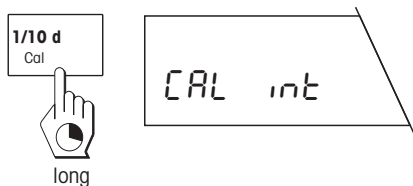

Start the adjustment operation by pressing and holding the «Cal» key. The balance briefly shows that adjustment (calibration) is being performed with the internal weight.

Note

If "SECURed 2" is switched on in the menu, the  key is blocked.

The following displays appear during the adjustment (calibration):

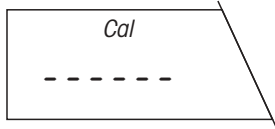

The internal adjustment weight is being loaded.



The internal adjustment weight is being raised.

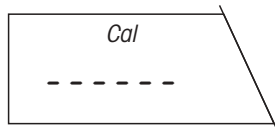

The balance is processing the adjustment results.

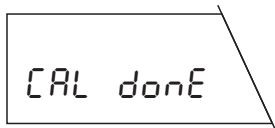

The balance reports successful completion of the adjustment (calibration).



The balance automatically returns to the weighing mode.

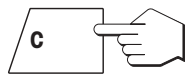

You can always abort an ongoing adjustment (calibration) by briefly pressing the «C» key.



If the adjustment (calibration) can not be performed properly (e.g. as a result of vibrations), the balance aborts the adjustment operation and "Abort" appears in the display. Press the «C» key to clear this message and restart the adjustment operation.

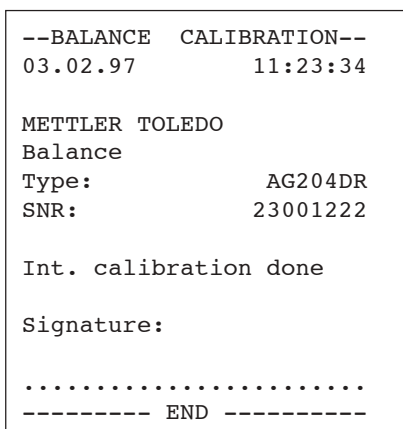

If your balance is connected to a printer, the adjustment (calibration) is recorded automatically in conformance with GLP. The record shown opposite is a specimen printed with the METTLER TOLEDO LC-P45 Printer. Depending on the attached printer, the printout may differ somewhat from the example shown.

5.7 Calibration with external weights (VariCal)

Depending on the setting selected in the menu (see Section 4.4), the calibration can be performed with the built-in or an external weight. The balance is set in the factory to calibration with the internal weight, which you are already familiar with from Section 2.6.

If you wish to calibrate your balance with an external weight, proceed as follows:

Make certain that "Calibration with external weights (VariCal)" is selected in the menu (see Section 4.4).

Ensure that the weighing pan is unloaded and close the doors of the draft shield. There is no need to tare the balance before the calibration.

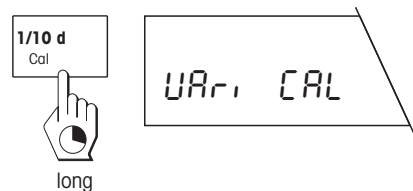

Start the calibration operation by pressing and holding the «**Cal**» key. The balance shows briefly that an external weight is being used for calibration.

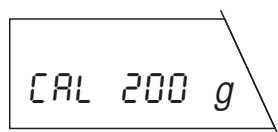

The balance now prompts you to select the desired weight.

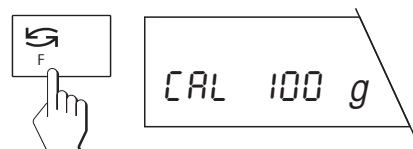

If you do not wish to calibrate with the suggested weight, you can select a different weight* by briefly pressing the «**F**» key. The available weights depend on the balance model.

*This option is not available with certified balances.

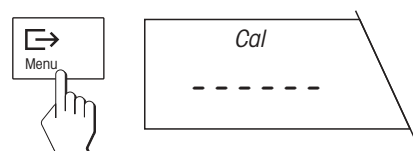

Confirm the selected weight with the «**Menu**» key. This also initiates the calibration procedure. The balance determines the zero point.

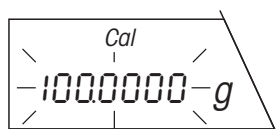

You are then prompted to place the weight on the pan.

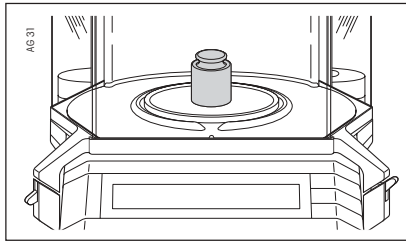

Place the requested weight in the middle of the weighing pan.

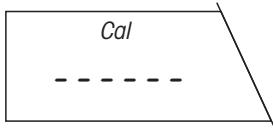

During the calibration, the horizontal segments are displayed.

Note

You can abort the ongoing calibration at any time by briefly pressing the «C» key.

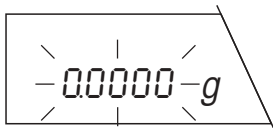

On completion of the calibration procedure, you are prompted to lift off the weight. Remove the weight from the weighing pan.

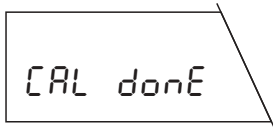

After removal of the weight, the balance shows the end of the calibration procedure and then returns to the weighing mode.

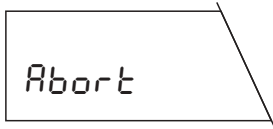
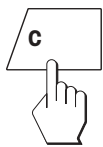

Note

If the calibration can not be performed properly (e.g. owing to vibrations), the balance aborts the calibration procedure and "Abort" appears in the display. Press the «C» key to clear this message and restart the calibration procedure.

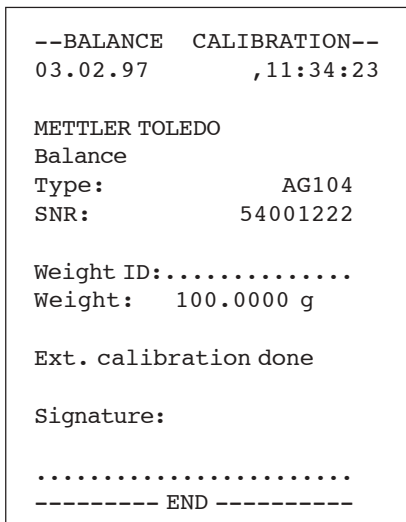

If your balance is connected to a printer, the adjustment (calibration) is recorded automatically in conformance with GLP. The record opposite is a specimen printed out with the METTLER TOLEDO LC-P45 Printer. Records printed with other printers may differ somewhat from the example shown.

5.8 Testing the balance with internal or external weight

You can test the accuracy of your balance at any time. This test is performed with either the built-in weight or with external weights, depending on your setting in the menu (see Section 4.4).

Testing the balance with the internal weight

Make certain that "Testing the balance with the internal weight (test int)" is selected in the menu (see Section 4.4).

Ensure that the weighing pan is unloaded and close the doors of the draft shield. There is no need to tare the balance before the test.

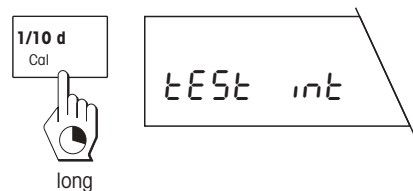

Initiate the test procedure by pressing and holding the «**Cal**» key. The balance briefly confirms that the test will be carried out with the internal weight.

The following displays appear during the test:

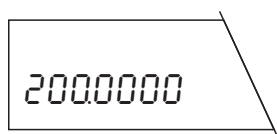

The internal weight is loaded.



The balance determines the zero point.

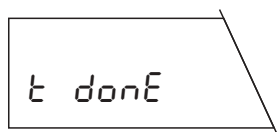

The balance confirms that the test has been performed.



The balance now shows the difference (deviation) between the calibration and the current test weighing for 10 seconds.

On completion of the test, the balance automatically returns to the weighing mode.

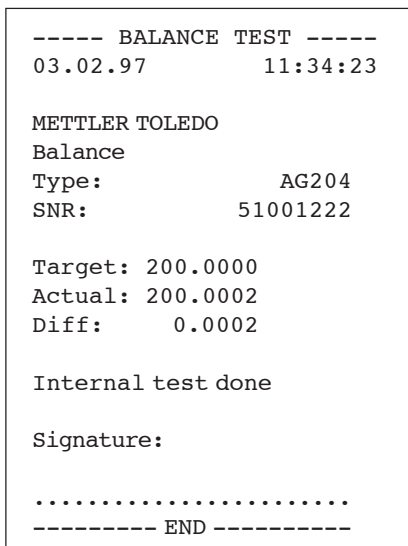

Notes

You can abort an ongoing test at any time by briefly pressing the «C» key. If the test can not be performed properly (e.g. owing to vibrations), the balance aborts the procedure and "Abort" appears in the display. Press the «C» key to clear this message and restart the test.

If your balance is connected to a printer, the determined deviation is automatically recorded. The record opposite is a specimen printed out with the METTLER TOLEDO LC-P45 Printer. Printouts may differ somewhat from the example shown, depending on the attached printer.

Testing the balance with external weights

Make certain that "Testing the balance with external weights (test E)" is selected in the menu (see Section 4.4).

Ensure that the weighing pan is unloaded and close all doors of the draft shield. There is no need to tare the balance before the test.

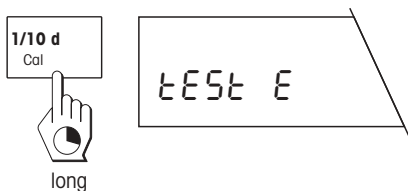

Initiate the test procedure by pressing and holding the «Cal» key. The balance briefly confirms that the test will be carried out with an external weight.

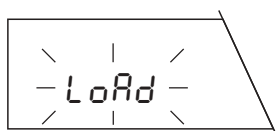

The balance prompts you to load the external weight. Place your weight on the pan.

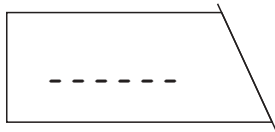

During the test the horizontal segments are displayed.

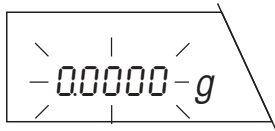

The balance now prompts you to remove the weight. Lift off the weight.

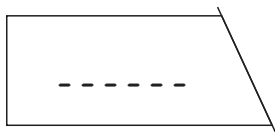

After removal of the weight, the balance processes the results of the test.

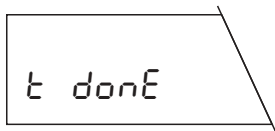

The balance confirms that the test has been performed and then returns automatically to the weighing mode.

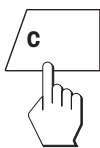

Notes

You can abort an ongoing test at any time by briefly pressing the «C» key. If the test can not be performed properly (e.g. owing to vibrations), the balance aborts the procedure and "Abort" appears in the display. Press the «C» key to clear this message and restart the test.

```

----- BALANCE TEST -----
03.02.97          15:21:17

METTLER TOLEDO
Balance
Type:             AG204
SNR:              00001222

Weight ID:.....

Target:  .....
Actual:  200.0005 g
Diff:    .....

External test done

Signature:

.....
----- END -----
    
```

If your balance is connected to a printer, the determined weight of the external test weight is automatically recorded. You can enter the target weight "Target" and the deviation "Diff" in the record by hand. The record opposite is a specimen printed out with the METTLER TOLEDO LC-P45 Printer. Printouts may differ somewhat from the example shown, depending on the attached printer.

6 Further important information regarding your AG balance

6.1 What if ...?

Modern semimicro and analytical balances such as the AG balances operate today so perfectly that they do not require a special weighing room or a stone weighing bench. State-of-the-art electronics shorten the weighing times and allow matching to a very wide range of ambient conditions so that the balances can be integrated directly in production processes. However, even today ambient influences can not be neglected. These usually involve physical effects which result in measurable weight changes for analytical balances (e.g. through slow evaporation, moisture uptake) or forces which act on the weighing sample (e.g. magnetism, electrostatics) and which are interpreted by the balance as weight changes. In this Section you will find recommendations which will help you identify such influences and eliminate or reduce their effects.

Problem: Measurement result is not stable, not reproducible or inaccurate

As it is not always easy to determine the exact cause of an unstable, nonreproducible or inaccurate measurement result, the most frequent error sources are listed below.

An unsuitable location

Disturbing factors can be powerful drafts (e.g. from air conditioners) or vibrations of the bench.

Look for a suitable location for the balance and match the vibration adapter to the ambient conditions (see Section 4.7).

Draft shield not closed sufficiently

Close all draft shield doors completely (see also Section 3.2).

Electrostatic charging of weighing samples and containers

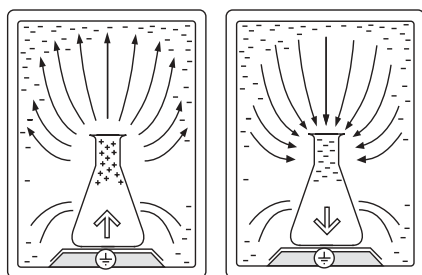

This charging frequently appears in heated rooms with **dry air** (less than around 40% rel. humidity) and with weighing samples made of **glass** or **plastic**. Electrostatic charging generates forces which can disturb the weighing. This leads to constantly changing and unstable display results.

In simple cases, it may simply be sufficient to place the weighing sample in a metal container.

Always use the smallest possible weighing container as the error tends to increase with increasing container size.

Increase the atmospheric humidity by using a humidifier.

Use a commercial antistatic gun or an antistatic spray. However, please note that these are not effective with all materials.

Magnetic weighing samples or containers

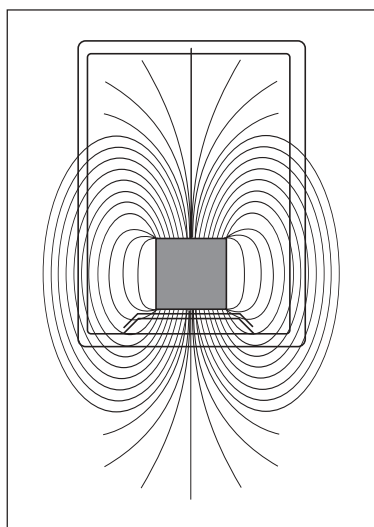

The magnetism of a weighing sample can lead to the weighing result being dependent on the position of the weighing sample on the weighing pan and to a result that is difficult to reproduce. Magnetic forces are interpreted wrongly by the balance as an additional load.

In simple cases it may suffice to increase the separation between the weighing sample and the weighing pan by placing the weighing sample **on** a nonmagnetic metal (aluminum) or glass vessel. Alternatively, you can use the hanger of your balance and weigh below the balance.

If possible, you should attempt to demagnetize the weighing sample and/or the weighing container.

Place the weighing sample in a soft magnetic container to screen the magnetic forces.

Weighing samples or containers not at ambient temperature

Weighing samples or containers which are warmer or colder than the balance surroundings can cause disturbing air currents and air buoyancy errors. Weight changes due to the uptake or loss of surface moisture can also result. These also lead to wrong or unstable weighing results.

Wait until the weighing sample and container have reached ambient temperature. Do not weigh the samples immediately after removal from a drying cupboard or refrigerator.

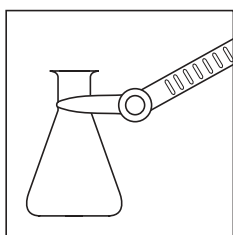

Never hold weighing samples or containers with your hand (approx. 35 °C), but only with tongs or tweezers. Never place your hand in the weighing chamber. This avoids temperature changes which can be caused by body heat.

Always use the smallest possible weighing container as errors tend to increase with increasing container size.

Weighing samples or containers which readily absorb or give off moisture

As a result of moisture uptake or evaporation, the weight of the weighing sample continuously increases or decreases.

All weighing samples or containers made of **wood, cardboard, paper, cork** (e.g. support for round-bottom flasks), **plastic** or **rubber** can absorb or lose so much moisture that the display is unstable and nonreproducible or wrong weighing results are displayed.

Whenever possible, containers made of the above materials should be replaced by metal or glass containers.

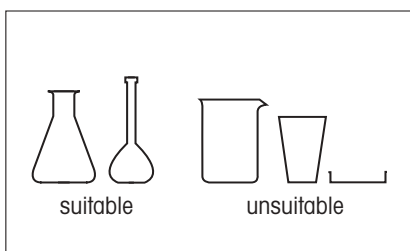

Always use the smallest possible weighing container as the error tends to increase with increasing container size. Further, you should use weighing containers with as narrow a neck as possible and a cover.

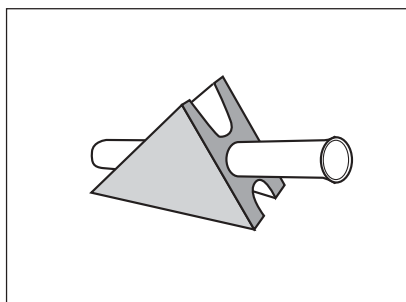

Instead of supports made of the materials mentioned above, use the optional triangular holder. You can order the triangular holder from METTLER TOLDEO with the number 210435.

Contamination

Powder, liquids or other residues at the edge of the weighing pan or between the weighing pan and the weighing chamber plate can lead to an unstable display if the weighing pan no longer has complete freedom of movement.

Clean the weighing pan and the weighing chamber plate (see Section 6.3).

Use only clean and dry weighing containers.

Problem: The weighing speed could be improved

The weighing speed or the stabilization time of your balance is mainly influenced by the following factors and settings.

Vibration adapter



If the ambient conditions permit, you can shorten the stabilization time of your balance by selecting the setting "1" of the vibration adapter (see Section 4.7).

Resolution of the weighing result

If your application permits, you should lower the resolution of the weighing result, i.e. suppress the display of the last decimal place. Your balance operates faster at a lower resolution (see Section 3.5).

Repeatability

Your balance reaches stability faster if you lower the repeatability. If, for instance, you select the setting "good repeatability" instead of "best repeatability", your balance releases the result as stable appreciably faster (see Section 4.9).

Draft shield



Your balance operates faster if you open the draft shield for loading the balance only as far as necessary. Disturbing air currents which penetrate the weighing chamber are thus kept to a minimum and severe temperature fluctuations avoided.

Use of the inner draft shield (option 238471) is recommended for the AG135, AG285. The smaller volume in comparison with the standard draft shield reduces disturbing air currents. The inner draft shield can be flexibly matched to your weighing needs and ensures quicker stability of the weighing result.

6.2 Error messages

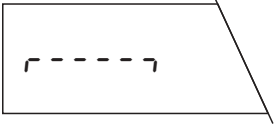
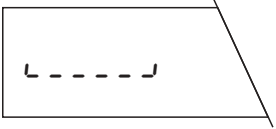
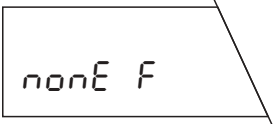
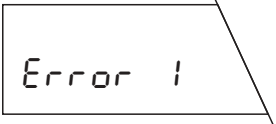
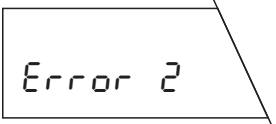
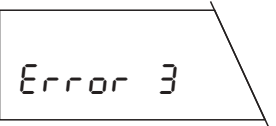
Error messages in the display draw your attention to incorrect operation or that the balance could not perform a procedure properly.

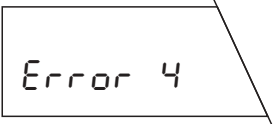
Error message	Cause	Rectification
	Overload	Remove sample from weighing pan.
	Underload	Check that weighing pan is mounted properly.
	No function preselected	Preselect desired function in the menu.
	No stability – On taring or calibration – On loading the reference weight for the "Piece counting" or "Percent weighing" functions	Ensure more stable ambient conditions. If not possible, check settings for repeatability and vibration adapter (see Sections 4.9 and 4.7).
	No or wrong calibration weight	Place requested weight on pan.
	Wrong reference (reference weight or reference number too low)	Increase reference weight or reference number.

Error message	Cause	Rectification
	Internal fault.	Do the following in this order: Switch balance off and then on with the « On/Off » key. Disconnect balance from power supply and reconnect. Calibrate balance. If rectification not possible: Inform customer service.
	Wrong or missing weighing pan.	Mount correct weighing pan. Unload weighing pan.
	Calibration or test could not be performed properly. The balance aborts the procedure. The cause of this error message is disturbing external influences (e.g. vibrations or a severe draft).	Press the « C » (a double beep sounds as confirmation) key to clear the error message. Close all draft shield doors. If need be, look for a better location for the balance.

6.3 Maintenance and care

Simple cleaning

Remove the weighing pan and then the weighing chamber plate. Clean the weighing chamber with the brush supplied.

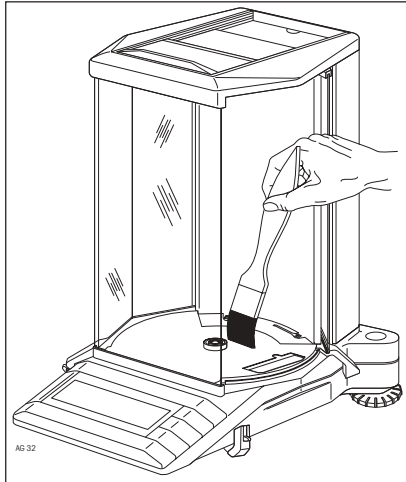

Thorough cleaning

Disconnect your balance from the power supply.

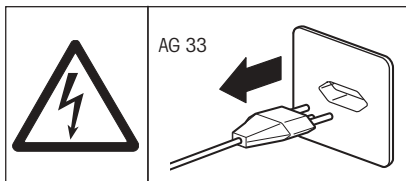

Remove the weighing pan (with the AG135, AG285 also the draft shield element).

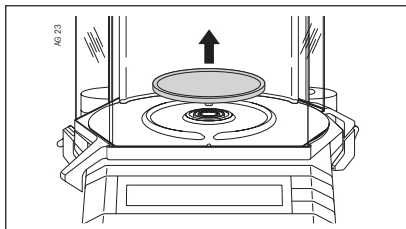

Remove the weighing chamber plate.

Close both doors of the weighing chamber.

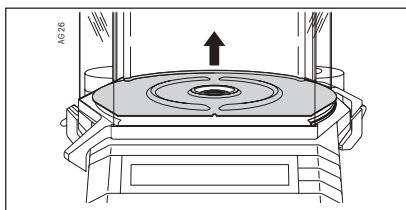

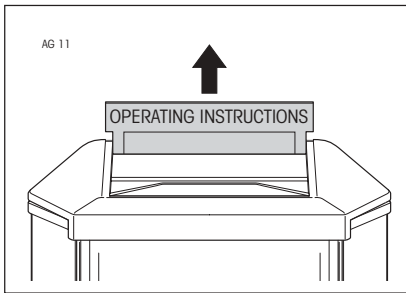

Remove the slide with the short-form operating instructions. Then carefully pull off the panes of the top weighing chamber door backwards from the balance. Hold the bottom pane firmly to avoid dropping it.

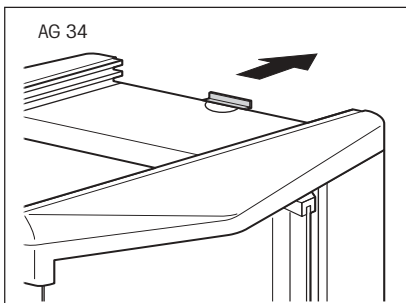

Undo the locking device of the weighing chamber cover.

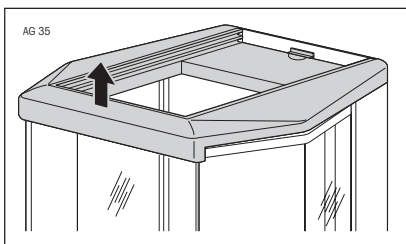

Carefully lift up the weighing chamber cover and remove.

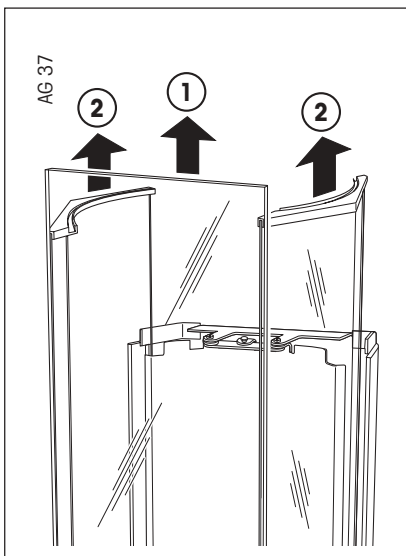

Remove the front door (1) and then lift the two side weighing chamber doors (2) out of their guide. Important: The two side doors can be removed only if they are in the very front ("closed") position!

Clean all dismantled single parts and the actual balance. However, on no account use abrasive cleaners or powerful solvents.

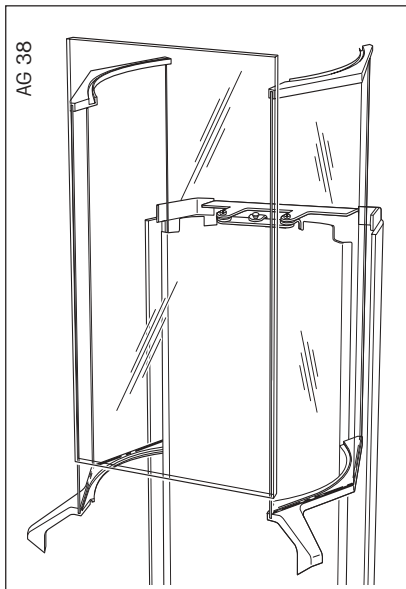

Assemble your balance in reverse order. When inserting the two side weighing chamber doors, ensure that they are correctly positioned in their guide slot. Do not forget to lock the weighing chamber cover!

Servicing

Regular servicing of your balance by an authorized service engineer ensures constant accuracy for years to come and prolongs the lifetime of the instrument. Ask your METTLER TOLEDO dealer for details of the available service options.

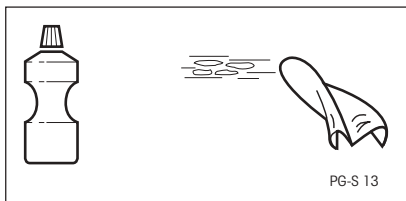

Cleaning

The balance housing and the weighing pan are made of high-grade, resistant materials. All commercially available cleaning agents may thus be used for cleaning.

AG balances can best be cleaned with a damp cloth.

6.4 LocalCAN universal interface

Every AG balance is fitted with the LocalCAN universal interface. As you can attach up to five peripherals simultaneously, it offers you high flexibility for data interchange.

The peripherals (see Section 7.3) from METTLER TOLEDO, which include the connection cables as standard, can be connected to the balance in a simple manner.

You can also attach your computer via an RS232C interface to the AG balance with the appropriate cable (see Section 7.3).

Communication is particularly well supported by the commands of the standard and extended command set. The reference manual (705184) that you receive with the LC-RS or LC-CL cable provides a descriptive overview of the functions of these commands.

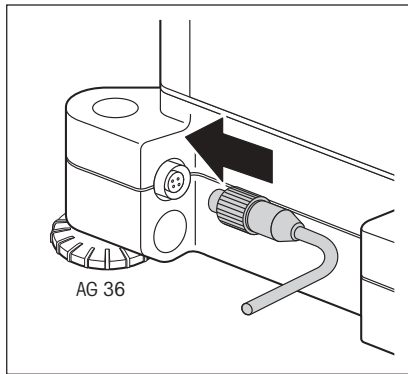

The features and benefits of the LocalCAN universal interface can be summarized as follows:

- Simultaneous attachment of up to five peripherals to a balance.
- Support of standard interfaces such as RS232C or CL.
- Rugged 4-pin connector with reverse voltage protection and pull-out protection.
- Reliable data transfer thanks to built-in CAN controller.
- Open cabling system, i.e. each peripheral unit except auxiliary displays have an additional connection.
- Simple configuration of the parameters without operating instructions of the AG balance.

The versatile features of the AG balances regarding documentation of the results can not be fully exploited until a printer, e.g. the LC-P45 from METTLER TOLEDO is attached. The printed results contribute to a simple manner of working following GLP/GMP.

Technical data of the LocalCAN universal interface

Cable length between two devices maximum 10 m.

Total of the cable lengths of all attached devices maximum 15 m.

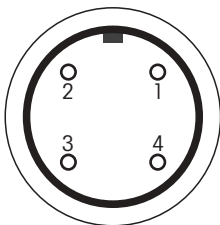

Pin assignment (balance end)

Pin No.	Signal
1	negative signal line (-CAN)
2	positive signal line (+CAN)
3	plus pin of power supply (V CAN) for peripherals
4	minus pin of power supply (0 V) for peripherals

7 Technical data and optional equipment

7.1 Technical data of the AG balances

Power supply

Power supply with AC/AC adapter	115 V, -20%+15%, 50/60 Hz,	195mA,	Sec: 12V, 50/60Hz, 1.25A
national power cable	230 V, -20%+15%, 50/60 Hz,	90mA,	Sec: 12V, 50/60Hz, 1.25A

Fusing

Temperature switch

Power supply AG balance

9.5–17.5 V, 50/60 Hz, 7 VA or 9–20 V =, 7 W



Use only with a tested AC adapter with SELV output current.

Ensure correct polarity 

Ambient conditions for AG balances

Use AG balances only in closed rooms

Height above sea level

up to 4000 m

Temperature

5–40 °C

Atmospheric humidity

80% RH @ + 30 °C

Overvoltage categor

II

Pollution degree

2

Standard equipment

Balance complete with feedthrough for weighing below the balance, fitting for antitheft device and integrated short-form operating instructions, protective cover for keypad and display, cleaning brush, AC adapter, holder for AC adapter, power cable, operating instructions, draft shield element (AG135, AG285 only)

Technical data	AG64	AG104	AG135	AG204
Readability	0.1 mg	0.1 mg	0.1 mg/0.01 mg ¹⁾	0.1 mg
Maximum capacity	61 g	101 g	101 g/31 g ¹⁾	210 g
Taring range	0...61 g	0...101 g	0...101 g	0...210 g
Repeatability (s)	0.1 mg	0.1 mg	0.1 mg/0.02 mg ¹⁾	0.1 mg
Linearity ²⁾	±0.2 mg	±0.2 mg	±0.2 mg/±0.03 mg ¹⁾	±0.2 mg
Stabilization time (typical)	3 s	3 s	3 s/12 s ¹⁾	3 s
Adjustment	internal, fully automatic motorized initiation (FACT) and test possibility for checking the sensitivity			
• with internal weight	100 g	100 g	100 g	200 g
• with external weights	50 g	50/100 g	20/50/100 g	50/100/200 g
Sensitivity				
• Temperature drift ²⁾	±1.5 ppm/°C	±1.5 ppm/°C	±1.5 ppm/°C	±1.5 ppm/°C
• Long-term drift ³⁾	±0.003 %	±0.003 %	±0.003 %	±0.003 %
Display	backlit LCD	backlit LCD	LCD, not backlit	backlit LCD
Interface	LocalCAN universal interface			
Weighing pan	ø 85 mm, stainless steel			
Effective height above pan	240 mm			
Dimensions (w/d/h) balance	205 x 330 x 310 mm			
Net weight/with packaging	4.9 kg/7.25 kg			

Technical data	AG204 DR®	AG245**	AG285
Readability	1 mg/0.1 mg ¹⁾	0.1 mg/0.01 mg ¹⁾	0.1 mg/0.01 mg/0.01 mg ¹⁾
Maximum capacity	210 g/81 g ¹⁾	210 g/41 g ¹⁾	210 g/81 g/41 g ¹⁾
Taring range	0...210 g	0...210 g	0...210 g
Repeatability (s)	0.5 mg/0.1 mg ¹⁾	0.1 mg/0.02 mg ¹⁾	0.1 mg/0.05 mg/0.02 mg ¹⁾
Linearity ²⁾	±1 mg/±0.2 mg ¹⁾	±0.2 mg/±0.03 mg ¹⁾	±0.2 mg/0.1 mg/±0.03 mg ¹⁾
Stabilization time (typical)	3 s	3 s/15 s ¹⁾	3 s/15 s ¹⁾
Adjustment	internal, fully automatic motorized initiation (FACT) and test possibility for checking the sensitivity		
• with internal weight	200 g	200 g	200 g
• with external weights	50/100/200 g	40/100/200 g	40/100/200 g
Sensitivity			
• Temperature drift ²⁾	±1.5 ppm/°C	±1.5 ppm/°C	±1.5 ppm/°C
• Long-term drift ³⁾	±0.003 %	±0.003 %	±0.003 %
Display	backlit LCD	LCD, not backlit	LCD, not backlit
Interface	LocalCAN universal interface		
Weighing pan	ø 85 mm, stainless steel		
Effective height above pan	240 mm		
Dimensions (w/d/h) balance	205 x 330 x 310 mm		
Net weight/with packaging	4.9 kg/7.25 kg		

¹⁾ Values in the fine range (AG135, AG245, AG285) or DeltaRange (AG204 DeltaRange®)

²⁾ In the temperature range 10 ... 30°C

³⁾ Sensitivity deviation/year after first-time startup with self-calibration FACT switched on

** Production phaseout from June 2000

7.2 Dimensions

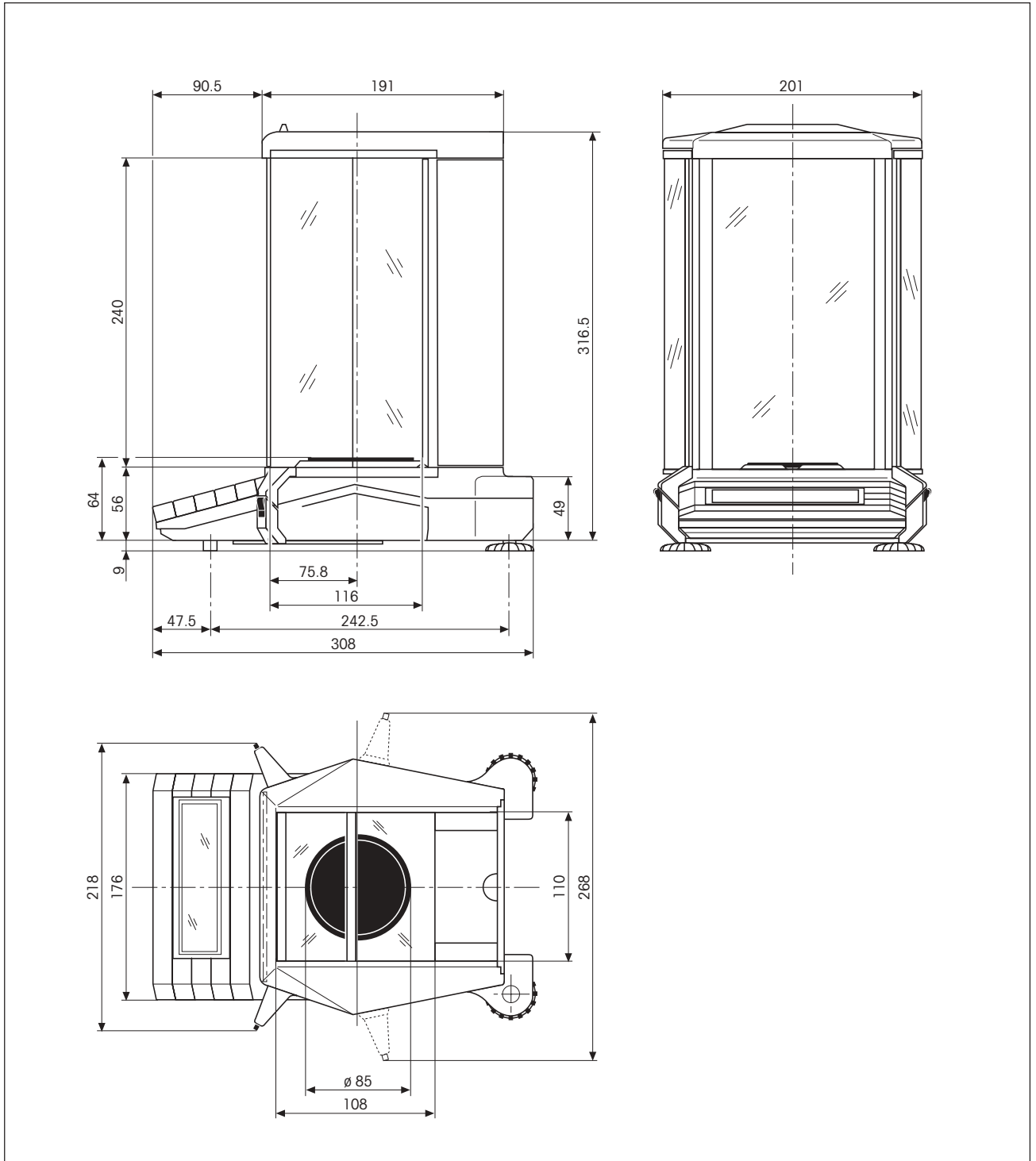

7.3 Optional equipment

With optional equipment from the METTLER TOLEDO product range the functionality of your AG balance can be increased. You have the following options available.

<p>Normal paper printers</p> <p>LC-P45 Printer: Printer with built-in applications (calibration and test records conforming to GLP, statistical evaluations, totalization functions, etc.)</p> <p>LC-P43 Printer: Printer for recording the results</p>	<p>229119</p> <p>229114</p>
<p>Auxiliary displays</p> <p>LC-PD: Auxiliary LCD with bench stand</p>	<p>229100</p>
<p>Foot switch</p> <p>LC-FS: Foot switch with adjustable function</p>	<p>229060</p>
<p>Cables and cabling accessories</p> <p>LC-RS25: Cable for the attachment of a printer or computer with RS-232C, 25-pin (m/f) such as IBM XT or compatible</p> <p>LC-RS9: Cable for the attachment of a computer with RS-232C, 9-pin such as IBM AT or compatible</p> <p>LC-CL: Cable for the attachment of a device with METTLER TOLEDO CL interface (5-pin)</p> <p>LC-LC03: Extension cable for LocalCAN, 0.3 m</p> <p>LC-LC2: Extension cable for LocalCAN, 2 m</p> <p>LC-LC5: Extension cable for LocalCAN, 5 m</p> <p>LC-LCT: T-piece for LocalCAN</p>	<p>229050</p> <p>229065</p> <p>229130</p> <p>239270</p> <p>229115</p> <p>229116</p> <p>229118</p>
<p>PowerPack</p> <p>PP-B10: External, rechargeable power source for 8–10 hours line-independent weighing operation</p>	<p>224500</p>
<p>Bar-code reader: LC-BCR usable for operation of the application software Differential weighing 238494</p>	<p>229145</p>

<p>Density determination</p> <p>Kit for the density determination of solids</p> <p>Sinker for the density determination of liquids (in conjunction with density kit 238490)</p> <p>Application software for the density determination</p>	<p>238490</p> <p>210260</p> <p>238491</p>
<p>Differential weighing</p> <p>Application software for differential weighing with bar-code reader LC-BCR</p> <p>Application software for differential weighing</p>	<p>238495</p> <p>238494</p>
<p>Antitheft device</p> <p>Antitheft device with metal bolt for bench feedthrough, without lock</p>	<p>238480</p>
<p>Inner draft shield</p> <p>Additional glass draft shield for all AG balances</p>	<p>238471</p>
<p>50 mm weighing pan</p> <p>Small weighing pan for AG135 and AG285 for a shorter stabilization time</p>	<p>238472</p>
<p>Triangular holder</p> <p>To hold weighing vessels (test tubes etc.)</p>	<p>210435</p>
<p>Receiver</p> <p>For the trapping and recycling of spilled weighing sample</p>	<p>238475</p>
<p>Protective covers</p> <p>Plastic protective cover for keypad and display</p> <p>Dust cover</p>	<p>238470</p> <p>238465</p>
<p>Transport case</p> <p>Transport case made of impact-resistant plastic for all AG balances, offers space for balance, PowerPack, LC-P4x printer and inner draft shield.</p>	<p>299036</p>
<p>Weights</p> <p>Available as OIML weights (E2 and F1, with certificate) or as calibration weights (not OIML): 20 g, 50 g, 100 g and 200 g.</p>	<p>on request</p>

Operating instructions or installation instructions are supplied with many options. For further information and to order the optional equipment, please contact your responsible METTLER TOLEDO dealer.

8 Appendix

8.1 Overview of menu

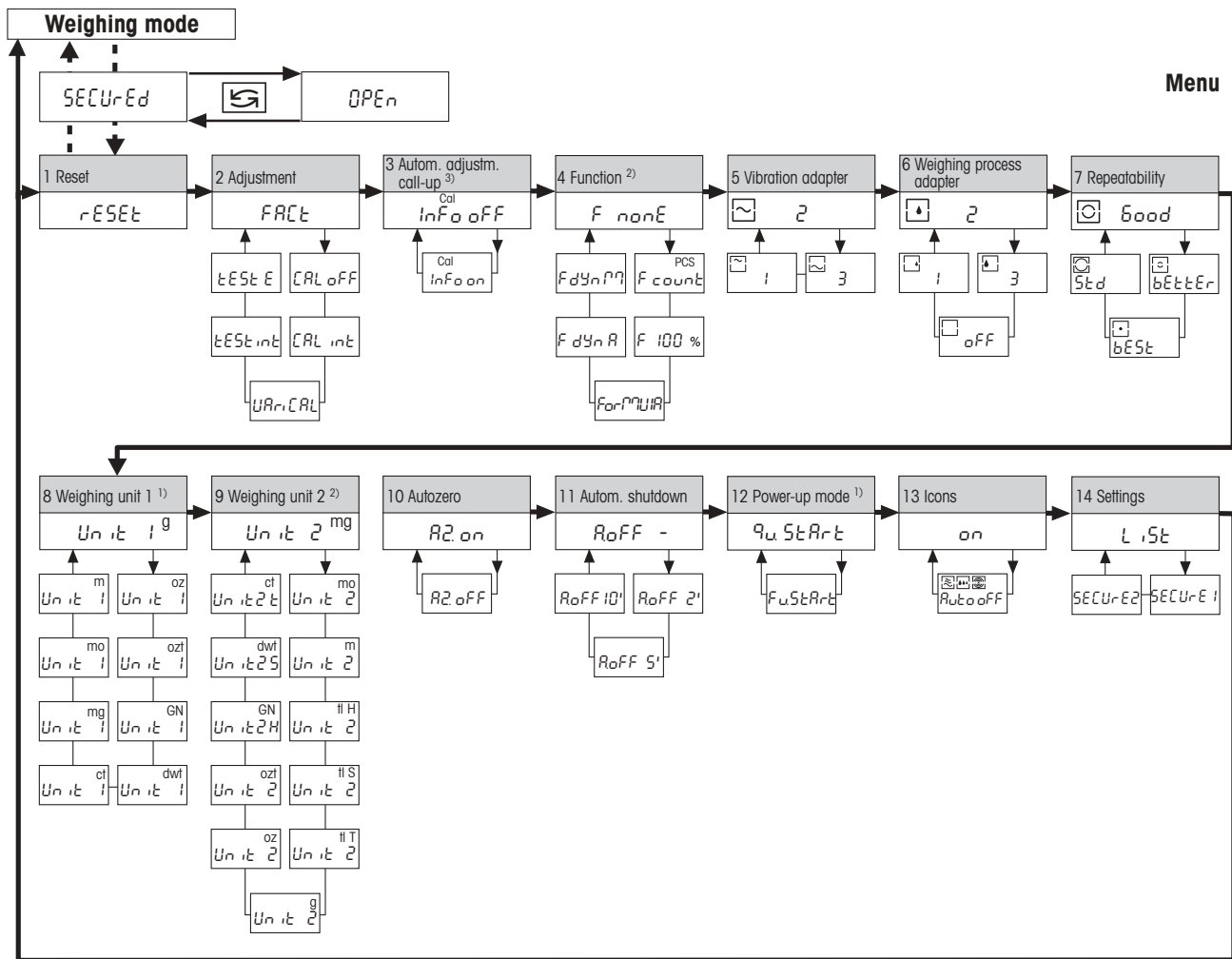

Notes

- 1) With certified balances, these menu options have a fixed setting and can not be changed.
- 2) With certified balances, only those weighing units/functions allowed by national weights and measures legislation can be selected.
- 3) This menu option is shown only if "FACT" or "CAL off" has **not** been selected in menu option 2.

8.2 Conversion table for weight units

Unit	Gram g	Milligram mg	Ounce oz (avdp)	Troy ounce ozt	Grain GN	Pennyweight dwt
1 g	1	1000	0.03527396	0.03215075	15.43236	0.6430149
1 mg	0.001	1	0.0000352740	0.0000321508	0.01543236	0.000643015
1 oz	28.34952	28349.52	1	0.9114585	437.500	18.22917
1 ozt	31.10347	31103.47	1.097143	1	480	20
1 GN	0.06479891	64.79891	0.002285714	0.002083333	1	0.04166667
1 dwt	1.555174	1555.174	0.05485714	0.05	24	1
1 ct/C.M.	0.2	200	0.007054792	0.006430150	3.086472	0.1286030
1 mo	3.75	3750	0.1322774	0.1205653	57.87134	2.411306
1 m	4.608316	4608.316	0.1625536	0.1481608	71.11718	2.963216
1 tl (HK)	37.429	37429	1.320269	1.203370	577.6178	24.06741
1 tl (SGP/Mal)	37.79937	37799.37	1.333333	1.215278	583.3334	24.30556
1 tl (Taiwan)	37.5	37500	1.322773	1.205653	578.7134	24.11306

Unit	Carat ct/C.M. (metr.) coil	Momme mo	Mesghal m	Tael tl (Hong Kong)	Tael tl (Singapore) (Malaysia)	Tael tl (Taiwan)
1 g	5	0.2666667	0.216999	0.02671725	0.02645547	0.02666667
1 mg	0.005	0.000266667	0.000216999	0.0000267173	0.0000264555	0.0000266667
1 oz	141.7476	7.559873	6.151819	0.7574213	0.75	0.7559874
1 ozt	155.5174	8.294260	6.749423	0.8309993	0.8228570	0.8294261
1 GN	0.3239946	0.01727971	0.01406130	0.001731249	0.001714286	0.001727971
1 dwt	7.775869	0.4147130	0.3374712	0.04154997	0.04114285	0.04147131
1 ct/C.M.	1	0.05333333	0.04339980	0.005343450	0.005291094	0.005333333
1 mo	18.75	1	0.8137461	0.1001897	0.09920800	0.1
1 m	23.04158	1.228884	1	0.1231215	0.1219152	0.1228884
1 tl (HK)	187.1450	9.981068	8.122056	1	0.9902018	0.9981068
1 tl (SGP/Mal)	188.9968	10.07983	8.202425	1.009895	1	1.007983
1 tl (Taiwan)	187.5	10	8.137461	1.001897	0.9920800	1

8.3 SOP (Standard Operating Procedure)

In the documentation of a GLP test, the SOPs represent a relatively small, but nonetheless important constituent. Practical experience has confirmed that SOPs produced in-house can be followed much better than those produced by an external, anonymous authority.

In what follows you will find a brief overview of the areas of responsibility with regard to SOPs as well as a checklist for the generation of an SOP.

Areas of responsibility regarding SOPs

Inspection and testing equipment manager	arranges that SOPs are produced approves SOPs with date and signature
Inspection and testing director	ensures that SOPs are available approves SOPs on behalf of the management
Personnel	follows the SOPs and other guidelines
GLP quality assurance	checks whether valid SOPs are available checks whether the SOPs are followed checks whether and how changes are documented

Checklist for the production of SOPs

Administrative matters	yes	no
1. Use of SOP forms		
2. Name of inspection and testing equipment		
3. Date (date when SOP produced)		
4. Storage identification (master reference plan) for SOPs		
5. Page numbering (1 of n)		
6. Title		
7. Date of putting into force		
8. Revision information		
9. Specification of departments responsible for implementation		
10. Dates and signatures: (a) Author(s) (b) Checker (c) Person responsible for authorization		
11. Distribution list		

Contents of the SOP	yes	no
1. Introduction and goal		
2. Material needed		
3. Description of work steps		
4. Description of documentation		
5. Data processing and evaluation		
6. Documents, samples, etc. to be stored		
7. Archiving instructions		

8.4 Index

A

Abort 52, 54, 56, 57, 63
Absolute weighing 31
AC adapter 8, 13
Accuracy 55
Adjustment 15, 27, 53, 69
Adjustment mode 3
Adjustment to acceleration due to gravity 15
Adjustment tolerance 51
Alphanumeric display 3
Ambient conditions 15, 30, 68
Ambient temperature 59
Animals 47
Antitheft device 12, 72
Asterisk symbol 49
Atmospheric humidity 68
Auto Zero 24, 35
Automatic adjustment call-up 24, 28
Automatic shutdown 24, 36
Automatic zero-point correction 24, 35
Auxiliary displays 71

B

Bar-code reader 71
Bottom 2
Brief keystroke 7

C

Cable 71
Calculated result 3, 49
Calibrating and testing 15, 55, 56
Care 64
CE declaration of conformity 7
Changing the location 11
Checkweighing 31
Cleaning 64, 66
Components 44, 45, 46
Conversion table for weight units 74
Coupling elements 3, 18

D

Data 23
Decimal places 20
Declaration of conformity 7
DeltaRange® 23
Density determination 72
Deviation 56
Differential weighing 10, 71, 72
Dimensions 69
Display 2, 69
Display test 37
Door handles 18
Draft 11
Draft shield 58, 61
Draft shield element 9, 10
Drift 35
Dual-range balance 22
Dynamic weighing 30, 47

E

Electrostatic charging 58
Error message 62
Evaporation measurement 35

F

F count 29, 39
FACT 6, 15, 27
Factory setting 27
Features 6
Fine dispensing 31
Fine range 22, 23
Foot switch 71
Formula 43
Formulation function 29, 43
Front 2
Function display 3
Functions 29, 39
Fuse 68

G

GLP 7, 15, 27
Good Laboratory Practice 7, 15

H

Hanger 49
Hazardous area 8
Holder 13, 72

I

Icons 37
Individual components 44
Inner draft shield 10, 61, 72
Interface 67
Internal adjustment 27, 51
ISO 14001 7
ISO 9001 7

K

Key designation 7

L

Leveling 12
Leveling control 3, 12
Leveling foot 3, 12
Line voltage 13
Linearity 69
List 38
LocalCAN universal interface 23, 67

M

Magnetism 59
Maintenance 64
Maximum capacity 69
Menu 24, 73
Menu overview 73
Menu setting 38

Moisture 60

N

N total 45

Net total 45

Net weight 69

O

Open 38

Operator keys 3

Optional equipment 71

Overload 62

Overview 2

P

Packaging 9

Percent weighing 42

Peripheral device 67

Piece counting 29, 39

Pin assignment 67

Power cable 9, 68

Power supply 13, 68

PowerPack 6, 13, 36, 71

Printer 23, 38, 71

Printing out settings 38

Protective cover 9, 11, 72

Putting into operation 9

Q

Quickstart 37

R

Readability 20, 23, 69

Rear 2

Receiver 72

Record 16, 45, 52, 54, 56, 57

Reference number 39

Reference weight 41, 42

Repeatability 32, 61, 69

Repro-Set 32

Reset 27

Resolution of the weighing result 61

S

Safety 8

Saving the settings 26

Secure 38

Selecting the location 11

Self-test 14

Semimicro range 22

Servicing 66

Setting 26

Short-form operating instructions 14

Simple formulation 29

Software version 14

SOP 7, 15, 75

Speed 20

Stability 48, 62
Stability detector 3, 20, 32
Stabilization time 69
Standard equipment 9, 68
Standard operating procedure 7, 15, 75
Standby 17, 36, 37
Sunlight 11
Switching off 17
Switching on 17
Switch-on mode 37

T

Target weight 57
Taring 19
Taring range 19, 69
Technical data 68, 69
Temperature fluctuations 11
Temperature 68
Test of the balance 28, 55
Thermal equilibrium 17
Total weight 45, 46
Transport case 72
Transport of the balance 9, 12

U

Underload 62
Unit 33, 34, 74
Unstable weighing samples 47

V

VariCal 28, 53
Vibration adapter 30, 62
Voltage 13
Voltage value 8

W

Warm-up phase 15, 27
Warm-up time 17
Weighing below the balance 49, 59
Weighing chamber plate 10
Weighing container 19, 46
Weighing mode 25, 26
Weighing pan 10, 63, 69
Weighing process adapter 31
Weighing result 23
Weighing types 31
Weighing unit 21, 33, 34, 74
Weighing-in aid 42
Weight 28, 51, 72

Z

Zero point 35

**To protect your METTLER TOLEDO product's future:
METTLER TOLEDO service assures you of quality, measuring accuracy
and preservation of value of the METTLER TOLEDO products for years to
come.**

Please send for details of our attractive terms of service.

Thank you.



P11780182

Subject to technical changes and to the availability
of the accessories supplied with the instruments.
Printed on recycled paper. Because we care.

© Mettler-Toledo GmbH 2004 11780182D Printed in Switzerland 0402/2.12

Mettler-Toledo GmbH, Laboratory & Weighing Technologies, CH-8606 Greifensee, Switzerland
Phone +41-1-944 22 11, Fax +41-1-944 30 60, Internet: <http://www.mt.com>



Artisan Technology Group is your source for quality new and certified-used/pre-owned equipment

- FAST SHIPPING AND DELIVERY
- TENS OF THOUSANDS OF IN-STOCK ITEMS
- EQUIPMENT DEMOS
- HUNDREDS OF MANUFACTURERS SUPPORTED
- LEASING/MONTHLY RENTALS
- ITAR CERTIFIED SECURE ASSET SOLUTIONS

SERVICE CENTER REPAIRS

Experienced engineers and technicians on staff at our full-service, in-house repair center

*InstraView*SM REMOTE INSPECTION

Remotely inspect equipment before purchasing with our interactive website at www.instraview.com ↗

WE BUY USED EQUIPMENT

Sell your excess, underutilized, and idle used equipment. We also offer credit for buy-backs and trade-ins. www.artisanng.com/WeBuyEquipment ↗

LOOKING FOR MORE INFORMATION?

Visit us on the web at www.artisanng.com ↗ for more information on price quotations, drivers, technical specifications, manuals, and documentation

Contact us: (888) 88-SOURCE | sales@artisanng.com | www.artisanng.com