



Artisan Technology Group is your source for quality new and certified-used/pre-owned equipment

- FAST SHIPPING AND DELIVERY
- TENS OF THOUSANDS OF IN-STOCK ITEMS
- EQUIPMENT DEMOS
- HUNDREDS OF MANUFACTURERS SUPPORTED
- LEASING/MONTHLY RENTALS
- ITAR CERTIFIED SECURE ASSET SOLUTIONS

SERVICE CENTER REPAIRS

Experienced engineers and technicians on staff at our full-service, in-house repair center

*InstraView*SM REMOTE INSPECTION

Remotely inspect equipment before purchasing with our interactive website at www.instraview.com ↗

WE BUY USED EQUIPMENT

Sell your excess, underutilized, and idle used equipment. We also offer credit for buy-backs and trade-ins. www.artisanng.com/WeBuyEquipment ↗

LOOKING FOR MORE INFORMATION?

Visit us on the web at www.artisanng.com ↗ for more information on price quotations, drivers, technical specifications, manuals, and documentation

Contact us: (888) 88-SOURCE | sales@artisanng.com | www.artisanng.com

USER'S GUIDE



EPM1000 **JOULEMETER/POWER METER** **USER'S GUIDE**



EPM1000
SINGLE CHANNEL
JOULEMETER/POWER METER
USER'S GUIDE

EPM1000 User's Manual.
Revised September 21, 1998
Published by
Molelectron Detector, Incorporated
7470 S.W. Bridgeport Road
Portland, OR 97224
(800) 366-4340 (503) 620-9069 FAX: (503) 620-8964
<http://www.molelectron.com>

Copyright © 1998 by Molelectron Detector, Inc.

All rights reserved. No portion of this book may be reproduced or transmitted in whole or in part in any form or by any means without permission of the publisher.

Document Number: QI-4.6

Table of Contents

Features & Description	
Welcome	5
Overview	5
Unpacking and Inspecting the Instrument	5
Safety Information	6
Manual Information	7
Features	7
Interface	7
Units and Ranges	7
Compatible Probes	8
Understanding the EPM1000 Internal Trigger	8
Understanding the EPM1000 External Trigger	10
Understanding the EPM1000 Speedup Feature	11
Description	12
Rear Panel	12
Front Panel	14
Operation	
Tutorial	19
Thermopile	19
Pyroelectric	20
Modes	21
Normal Mode	21
Auto Mode	21
Average Mode	21
Statistics Mode	22
Settings	22
System Settings	22
Trigger Settings	26
Communications Settings	27
Programming	
Connection Methods	29
Commands	29
Audible Beeper	30
Average Batch Size	30
Backlight	30
Channel Store/Recall	30
Communications Error	31
Display Current Reading	31
Identification	31
IEEE-488 Address	31
Line Frequency	32

Operating Mode	32
Output Buffer	32
Output Continuous	32
Output Depth	33
Output Dump	33
Output Format	33
Probe Type	36
Range, Current	36
Range, Maximum/Minimum	37
Reset	37
Responsivity	37
RS-232 Baud Rate	37
RS-232 Parity	38
RS-232 Stop Bits	38
Self Test	38
Speedup	38
Statistics Batch Size	39
Statistics Restart Mode	39
Statistics Send	39
Statistics Start	40
Trigger Level	40
Trigger Source	40
Units	40
Zero	41
Programming Example	42

Maintenance, Service, & Calibration
--

Troubleshooting	43
Fuse Replacement	45
Instrument Calibration and Service	45

Specifications

Electrical/Mechanical	47
Display	47
Ranges	47
Resolution	47
Maximum Rep Rate	47
Linearity	47
A/D Digital Resolution	47
Input Impedance	47
Noise Equivalent Voltage (NEV)	47
Analog Output	47
External Trigger Input	47

Electronic Accuracy	48
System Accuracy	48
Maximum Pyroelectric Pulse Width	48
Internal Trigger	48
RS-232 Baud Rates	48
Power Requirements	48
Dimensions	48
Weight	48
Firmware Revisions	48
Factory Defaults	49
Warranted Characteristics	49
Power	49
Atmospherics (Temperature)	49
Atmospherics (Relative Humidity)	49
Atmospherics (Altitude)	49
Dynamics (Random Vibration)	49
Emissions	50
Susceptibility	50
Index	51

Features & Description

Welcome

Overview Thank you for purchasing an EPM1000. The EPM1000 is a laboratory, AC powered meter that can measure both pulsed and CW lasers: energy, power, voltage, and (pulsed only) frequency. The EPM1000 is compatible with all of Molelectron Detector, Inc.'s pyroelectric, silicon, and PowerMax® thermopile probes.

The EPM1000 is fast, accurate, and easy to use. It features:

- a large, custom four-digit LCD
- a 3½" mirrored analog meter
- four operating modes
- many functions
- peak reading with automatic baseline drift compensation
- results displayed in selected units
- an analog output
- an adjustable internal trigger
- an external trigger input
- an RS-232 communication port
- an IEEE-488 communication port

All instrument features are available via the communication ports.

Unpacking and Inspecting the Instrument

The equipment described in this manual was delivered to the carrier in good condition and properly packaged. Immediately open all boxes comprising this shipment and inspect the instruments for lost or damaged parts, including case damage, proper button function, etc.

In the unlikely event of damage:

1. Save all shipping boxes and cartons for inspection by the carrier until the claim is settled.
2. Notify the carrier or transfer agent immediately for a prompt inspection of the claimed loss or damage.
3. File the claim with the carrier.
4. If necessary, order replacement parts from Molelectron Detector, Inc. and collect the invoice amount from the carrier.

Safety Information

Review this safety information carefully to avoid injury and prevent damage to this instrument or any instrument connected to it. There are no user serviceable parts in the EPM1000. For Service, please see *Maintenance, Service, and Calibration*.

This manual uses two terms to describe hazardous conditions: **Caution** and **Warning**.

Warning indicates serious injury or death may occur.

Caution indicates possible damage to equipment.



Warnings:

- Use only the power cord specified for the EPM1000. The grounding conductor of the cord must be connected to earth ground.
- Do not operate the EPM1000 if its panels are removed or any of the interior circuitry is exposed.
- Do not operate the EPM1000 in wet or damp conditions or in an explosive atmosphere.



Cautions:

- Do not operate the EPM1000 from a power source which applies more than the voltage specified.
- Do not apply a voltage outside the specified range to any of the terminals.
- Use only the fuse type and rating specified for the EPM1000.
- Provide proper ventilation to the EPM1000, particularly near the ventilation slots in the back.
- Do not operate the EPM1000 with suspected failures. Refer damaged units to qualified Molelectron service personnel.
- Never connect or disconnect a powered probe while the EPM1000 is on. Damage could result to the probe, the EPM1000 or both.

Manual Information This manual can be read sequentially, but should be stored near the EPM1000 and used as a reference.

There are five basic components of this manual:

- *Features & Description* An introduction to the EPM1000 and its features and controls
- *Operation* A tutorial and complete description of the EPM1000's functions
- *Programming* A list of commands and examples of communicating with the EPM1000 via remote
- *Maintenance, Service, and Calibration* A list of frequently asked questions, and information regarding calibration and service
- *Specifications* The standards and limits of the EPM1000

This manual was composed using Microsoft® Word and Adobe® PageMaker®.

Features

Interface The EPM1000 features a standard RS-232 9-pin connector on the back panel. This can connect to any similar RS-232 port of a host PC.

IEEE-488 (or GPIB) interface is standard on every EPM1000. Use this port for the following advantages:

- Transfer rates up to one Mbyte/sec
- Can be added to an already existing instrument chain
- Can be used with other EPM1000's on the same host computer

Units and Ranges The EPM1000 can measure:

- *Energy* 1 pJ to 10 J in 28 ranges (depending on the probe type)
- *Power* 1 mW to 10 kW in 15 ranges
- *Frequency* 0.1 Hz to 500 Hz
- *Volts* 2 mV to 30 V (for pyroelectric/silicon probes)
- *Volts* 200 μ V to 1 V (for thermopile probes)

For more details, see *Specifications*.

Compatible Probes

The EPM1000 functions with any of Molectron's pyroelectric/Joulemeter probes with names of the form Jx (for example: J25, J3, J4).

All PowerMax® thermopile probes will function with the EPM1000. Connect thermopile probes that terminate with a BNC connector to the EPM1000 with the PM-BNC adapter (available separately).

Understanding the EPM1000 Internal Trigger

For greatest accuracy and repeatability, the EPM1000 must trigger reliably for each laser pulse.

The EPM1000 should be triggered externally, via the Trigger In connector, for best results. This is particularly true in a noisy environment. The EPM1000 can be set to synchronize with either the positive or negative transition of this external signal.

Without a reliable external trigger, set the EPM1000 to extract an artificial trigger from the incoming signal. This is called Internal Triggering.

To successfully extract an internally generated trigger, set the EPM1000 to a range such that the incoming signal is at least 5% of the full scale. Set the trigger level for at least 2% above the noise level and at least 2% below the peak height.

For example, with a peak height of 300 mJ, set the EPM1000 to a range of 3 J. A peak will occur at 10% of full scale, well above the 5% level. The trigger level should not be set higher than 8%. If the noise level is 5% of full scale (approximately 150 mJ) then the trigger level should be set no lower than 7%.

In Figure 1, the EPM1000's internal trigger threshold has been set to 8% (dashed line). Pulse A will definitely not generate a reliable trigger. Pulse B *may* generate a trigger, but not reliably. Pulses C and D will definitely generate reliable triggers.

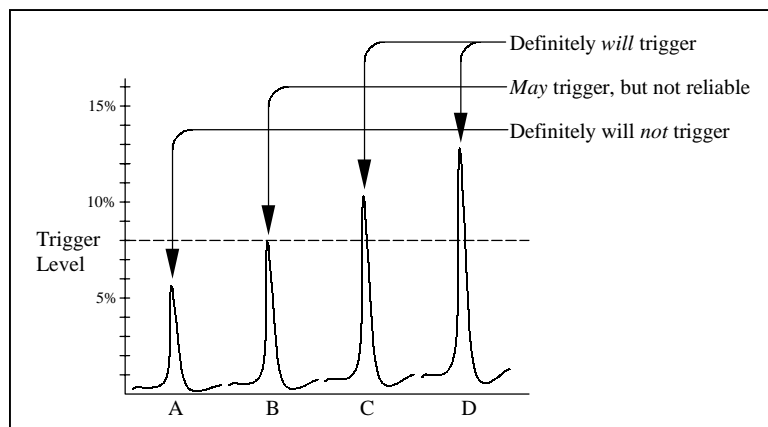

Figure 1: Pulses which will or will not trigger as valid

Understanding the EPM1000 Internal Trigger (continued)

The ranges differ by powers of ten. A full-scale signal on one range may not trigger on the next higher range unless the trigger level is set to less than 10%. For example, a near full-scale signal of 280 mJ on the 300 mJ range is less than 10% of full scale on the next higher range (2 J) and would not trigger the reading, so adjust the trigger level to less than 8% for reliable triggering.

The trigger is synchronous with the leading edge of the pulse, but the actual peak is determined algorithmically by sampling the input signal near the trigger. From the trigger point forward, the algorithm searches for peaks and from the trigger point back, it searches for a baseline.

The EPM1000 can be programmed to ignore triggers for a specified time after a valid trigger. This prevents “false” triggers in pulse tails from accidentally starting a new sample (see Figure 2). This amount of delay time is called the Trigger Holdoff (see *Operation -- Operation Settings -- Trigger Settings -- Trigger Holdoff*). The EPM1000 is set at the factory with a 1 ms trigger holdoff.

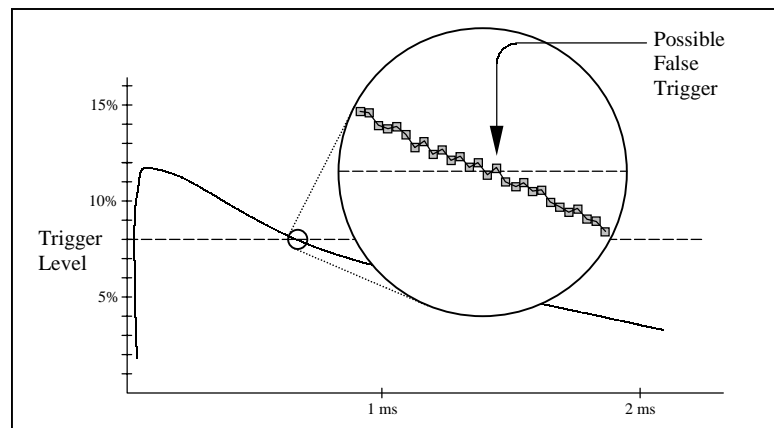

Figure 2: How a false trigger could occur

Understanding the EPM1000 External Trigger Circuit

The external trigger for the EPM1000 is a 100Ω resistor (R64) in series with an optical coupler (U39). The coupler is protected by an additional diode (CR20). A high signal at the BNC forward biases the optocoupler diode and triggers the EPM1000.

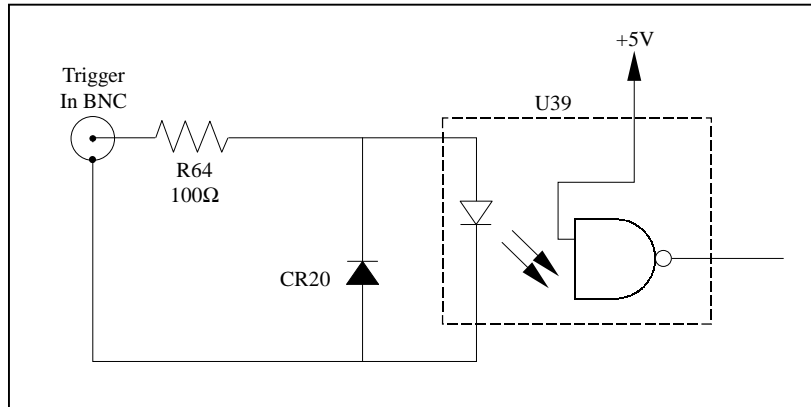

Figure 3: The external trigger circuit for the EPM1000

Typical instrumentation will trigger an EPM1000 reliably. In the event that the triggering instrument cannot source enough current, the current supply must be boosted externally, via a buffer circuit such as shown in Figure 4.

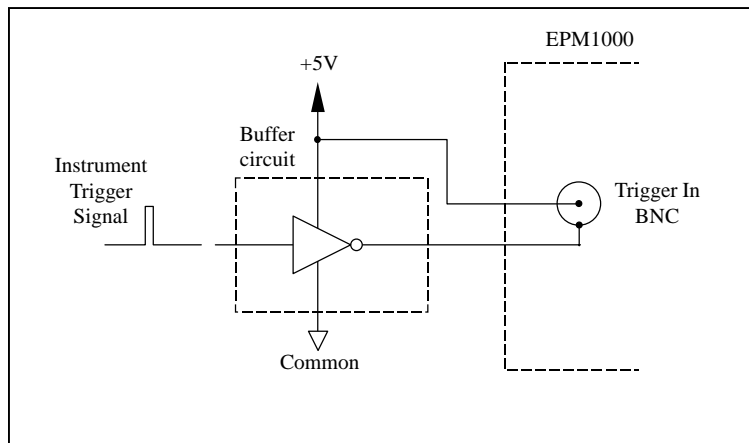

Figure 4: Method to boost source current of triggering device

Understanding the EPM1000 Speedup Feature

For most applications, it's important to determine laser power quickly and accurately. However, some probes, such as the PM5K, which can measure power as high as 7500 Watts, have a long response time. The EPM1000 solves this problem by using probe information and an internal algorithm, called the Speedup feature, to quickly estimate the final power value.

For long response time probes, the Speedup feature significantly reduces the amount of time required for an estimated value.

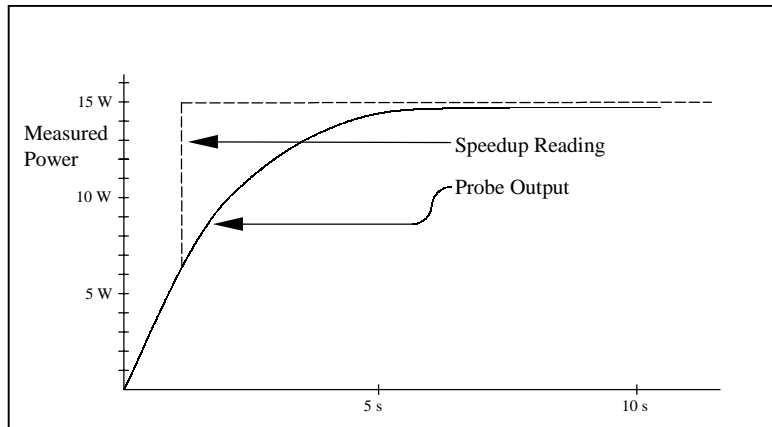

Figure 5: The Speedup feature estimating a 15 W power reading

While the Speedup feature is useful for a stable laser output, it is not well suited for constantly changing or unstable laser outputs, as it tends to amplify noise. The most accurate way to measure power, particularly for unstable laser outputs, is to deactivate the Speedup feature.

The fastest and most accurate results can be achieved when the Speedup feature is in Selective mode. In Selective mode, the EPM1000 determines when the Speedup algorithm should be used. Whenever the actual measurement and the estimated measurement differ by more than 5%, the Speedup data will be displayed, but when the actual measurement falls within 1% of the estimated measurement, the EPM1000 displays the actual measurement. For most probes, using the Selective mode is very effective, taking advantage of the Speedup feature when needed and relying on the EPM1000's raw accuracy otherwise.

Description

Rear Panel

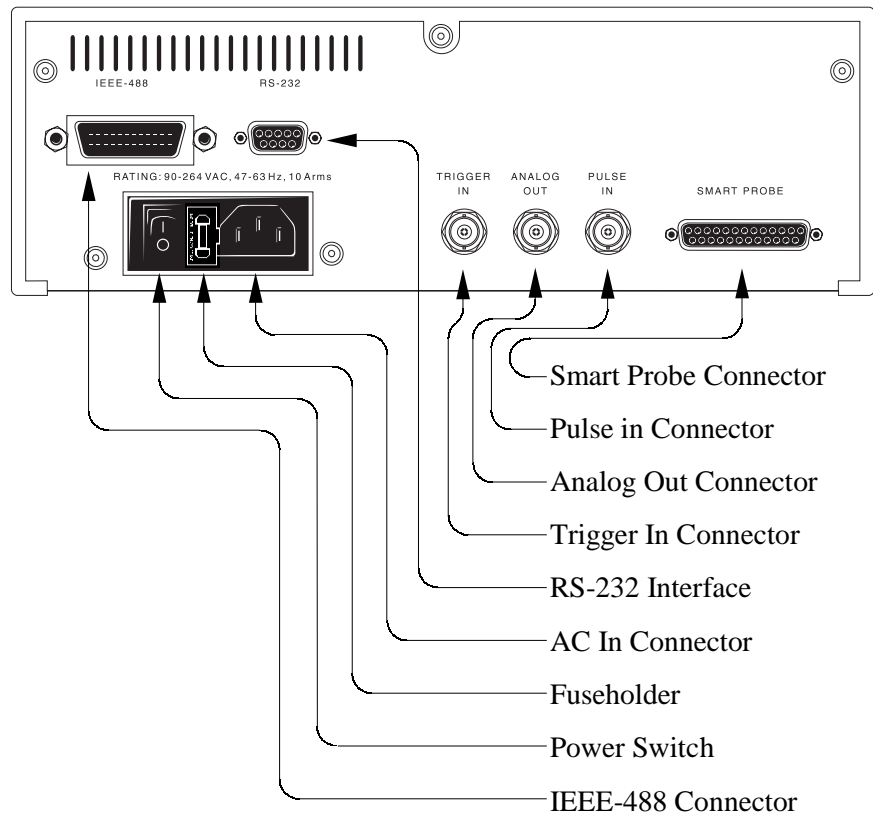

Figure 6: EPM1000 Rear Panel

Smart Probe

This connection is for all of Molectron's PowerMax® probes, as well as specially powered Joulemeter probes.

Pulse In Connector

This connects a pyroelectric laser energy probe and is internally terminated with $1M\Omega$ impedance. Probes with $50\ \Omega$ impedance (such as J3, J3S, and J4 probes) must use a $50\ \Omega$ feed-through terminator, available through Molectron Detector, Inc., or equivalent to Pomona P/N 4119.

Analog Out Connector

This connection provides 0 to 1.81 VDC output into loads $\geq 600\ \Omega$. The output impedance is $100\ \Omega$. The update rate is 3 Hz. The signal represents the input pulse amplitude scaled to the full scale of the display. For example, if the EPM1000 is set on the 300 mJ range, then the Analog Out value will be 1.81 V when the input pulse is 300 mJ. If the input pulse were 150 mJ, then the Analog Out value would be approximately 905 mV. Note that although in some instances the EPM1000's display will exceed the selected range, under no circumstances will the Analog Out value exceed 1.81 VDC.

Rear Panel
(continued)*Trigger In Connector*

This input line accepts synchronized pulses from the laser. It is electrically isolated from the EPM1000 and consists of a 100 Ω resistor in series with an optoisolator. It can be set from the front panel or via remote to trigger on the rising or falling edge of the input signal. This input only triggers pyroelectric/silicon measurements.

RS-232 Interface

The EPM1000 acts as a DTE (Data Terminal Equipment) device through this 9-pin RS-232 connector. It mates with a standard 9-pin straight-through serial cable to a typical IBM-AT compatible PC, or other DCE (Data Communications Equipment) device. Hardware handshaking is implemented.

Pin	Assignment
1	DCD (not used in EPM1000)
2	RXD
3	TXD
4	DTR
5	GND
6	DSR
7	RTS
8	CTS
9	RI (not used in EPM100)

Table 1: RS-232 pin assignments



AC In Connector

Connect only to the factory supplied, polarized AC cord. The EPM1000 will function at AC voltages from 90 to 264 VAC at frequencies between 50 Hz and 60 Hz.

Fuseholder

Replace this fuse with only a 240 VAC/1 A fast-blow fuse. A convenient replacement fuse is stored in the holder. See *Maintenance, Service, and Calibration* for replacement instructions.

Power Switch

Press the  symbol for ON and the  symbol for OFF.

IEEE-488 Connector

This connector mates with a standard IEEE-488 cable.

Front Panel

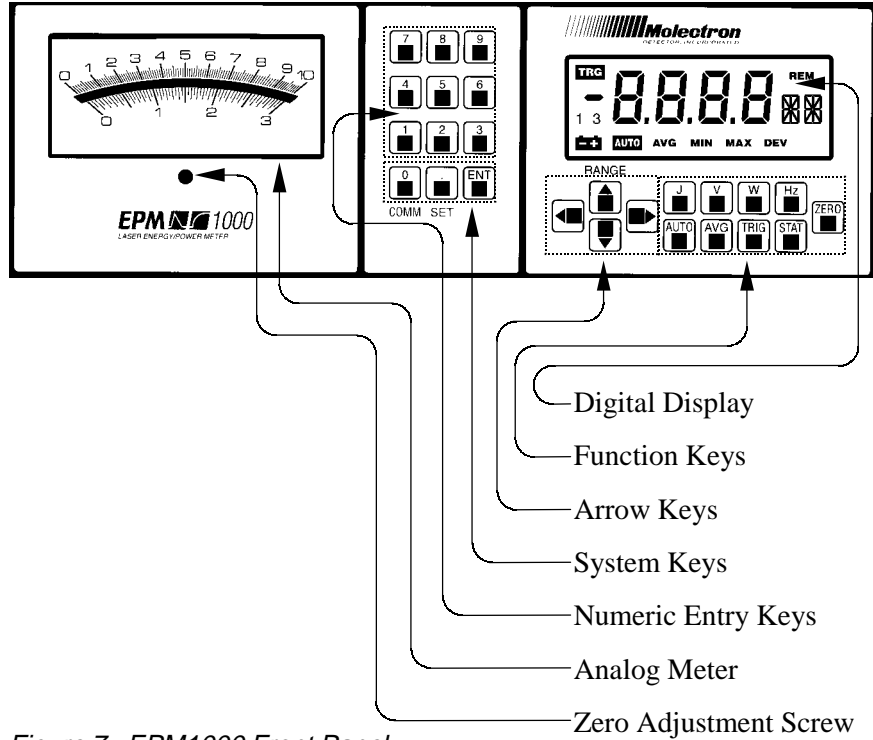

Figure 7: EPM1000 Front Panel

Digital Display

Twelve different readouts appear on the EPM1000's liquid crystal display (see Figure 6).

- *REM Annunciator* Indicates the EPM1000 is under remote control.
- *Numeric Display* Typically indicates measurement value.
- *Alphanumeric Display* Typically indicates measurement unit, and some auxiliary functions.
- *DEV Annunciator* Indicates the EPM1000 is displaying the standard deviation of the current batch in Statistics Mode.
- *MAX Annunciator* Indicates the EPM1000 is displaying the maximum batch value in Statistics Mode.
- *MIN Annunciator* Indicates the EPM1000 is displaying the minimum batch value in Statistics Mode.
- *AVG Annunciator* Indicates one of two possible states. When the annunciator is steadily activated, the EPM1000 is displaying the mean batch value in Statistics Mode. When the annunciator is blinking, the EPM1000 is in Average Mode.
- *AUTO Annunciator* Indicates the EPM1000 is in autorange mode.

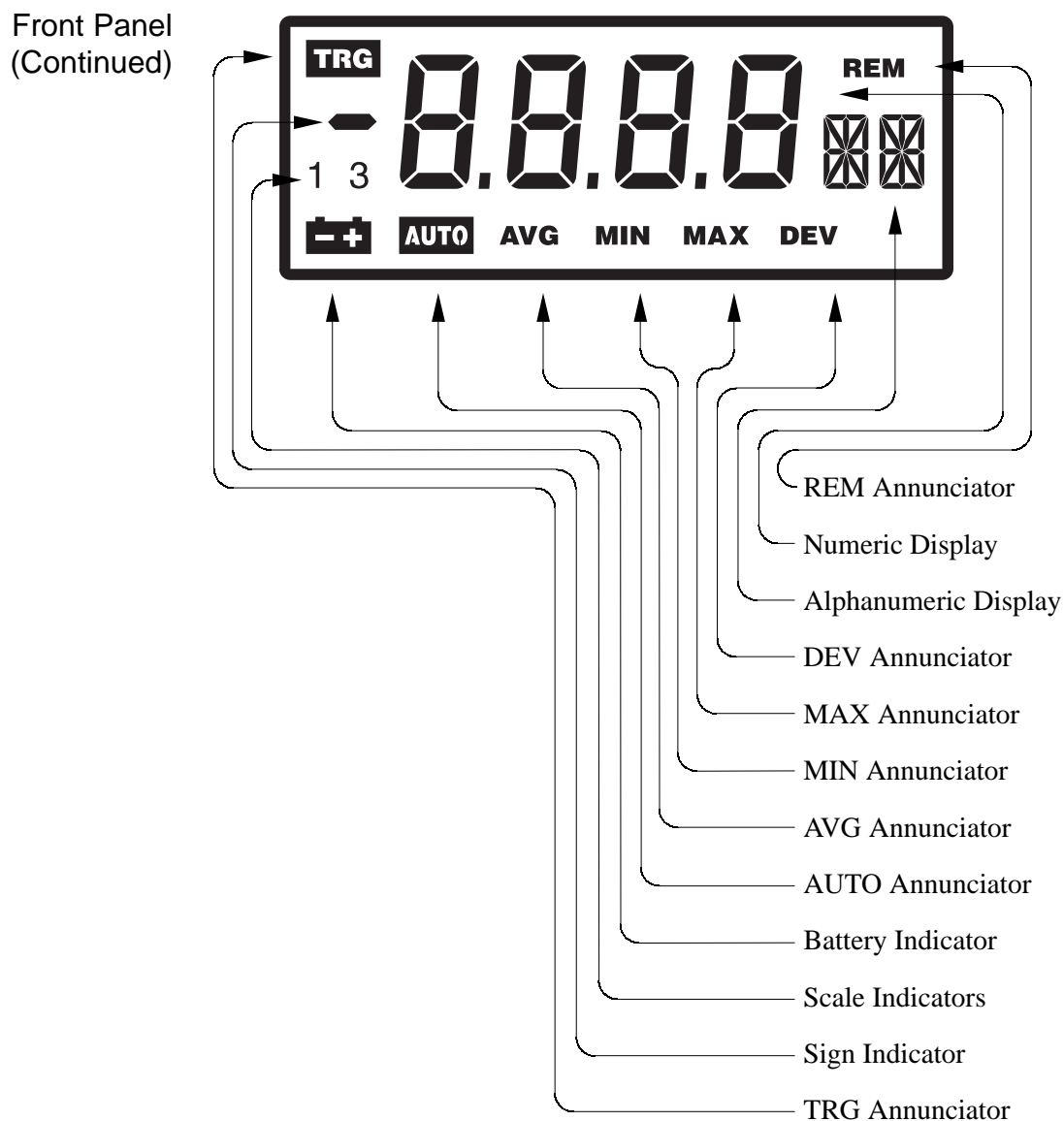

Figure 8: EPM1000 LCD Digital Display

- *Battery Indicator* No function in this unit.
- *Scale Indicators* Indicate which scale of the analog meter (0-10 or 0-3) is being used.
- *Sign Indicator* Indicates a negative reading during thermopile measurements.
- *TRG Annunciator* Indicates the EPM1000 is receiving a valid input pyroelectric/silicon pulse.

Front Panel
(Continued)

Function Keys

Nine different keys control the primary functions of the EPM1000.



Sets the instrument to report incoming energy in Joules during pyroelectric/silicon measurements.



Sets the instrument to report probe output in Volts -- pulse height for pyroelectric/silicon measurements, DC voltage during thermopile measurement.



Sets the instrument to display power in Watts, during pyroelectric/silicon or thermopile measurements.



Sets the instrument to display the repetition rate for a laser during pyroelectric/silicon measurements, or to modify the wavelength compensation during thermopile measurement.



Sets the instrument into Autoranging. Autorange will not function with pyroelectric/silicon measurements that are internally triggered. Zero all thermopile ranges to allow the autorange function to operate properly when taking thermopile measurements.



Sets the instrument to Average mode.



Sets the trigger source and internal trigger level during pyroelectric/silicon measurements.



Sets the instrument into Statistics mode.



During thermopile measurements, press this key to assign the current value as a relative zero. Press this key in autorange mode to zero all ranges. Press this key to clear errors while entering data or setting such values as responsivity.

Arrow Keys

During a live reading, use the up/down arrow keys to change ranges. While setting parameters, use the up/down arrow keys to choose system parameters and the right/left arrow keys to select options for those parameters.

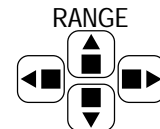

Front Panel
(Continued)

System Keys

These three keys navigate through the EPM1000's configuration menus.



This key permits modification of the EPM1000's communication parameters (such as baud rate, I/O port, etc.) by offering access to the communications parameters menu. It is also the "0" key for the *Numeric Entry Keys*.



This key permits modification of the EPM1000's system parameters (such as display speedup and backlight) by offering access to the system parameters menu. It also acts as the decimal point entry key for the *Numeric Entry Keys*.



Pressing this key during configuration menus or while entering a number on the numeric keypad will accept the currently displayed value or number.

Numeric Entry Keys

Use this keypad for data entry, such as detector responsivity or setup information such as statistics batch size.

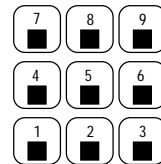

Analog Meter

The EPM1000's analog meter uses two scales, one marked 0-10 and one marked 0-3. The 1 and 3 scale indicators on the LCD indicate respectively which scale the EPM1000 is using.

Zero Adjustment Screw

Use this screw to adjust the zero of the analog meter.

Operation

Tutorial

Thermopile

Measuring laser power using a PowerMax® thermopile probe is easy with the EPM1000. It automatically searches for an attached thermopile probe when powered up. An attached thermopile probe is queried and the probe's responsivity is automatically programmed into the EPM1000.



Warning: Follow all laser safety procedures. Laser must be blocked or switched off before beginning this procedure.







Caution: Do not exceed the power/energy density limits for the thermopile probe as defined in the probe's data sheet.

1. Place the PowerMax® probe in the path of the laser beam in such a way that the beam will strike the center of the probe surface when power is restored.



Caution: The EPM1000 must be off before connecting or disconnecting any powered probe such as the PowerMax® thermopile probe. Connecting or disconnecting a probe while the EPM1000 is on will damage the probe.

2. Connect the detector to the EPM1000 rear panel 25-pin Smart Probe connector, using the probe's cable.
3. Turn the EPM1000 on. If the EPM1000 isn't in normal mode, place it into Normal Mode by pressing .
4. Switch the laser on or unblock the beam. Verify proper beam alignment on the probe surface.
5. Adjust the range up or down by pressing  or  respectively, until 30 to 300 counts appear on the digital display. A display reading of OL indicates the selected range is too low.
6. Block the beam and wait for the EPM1000 display to settle. Press  to zero the display.
7. Unblock the beam and wait for the EPM1000 to settle on the new, more accurate reading. If the probe responds too slowly to power changes, activate Display Speedup and the EPM1000 will display an estimate of the final value within a few seconds.





Pyroelectric

If an EPM1000 doesn't detect the presence of a PowerMax® thermopile probe, it monitors the pyroelectric/silicon input for signal peaks. The EPM1000 will not automatically read the probe's responsivity as it does with a thermopile probe, so the responsivity must be programmed separately.



Warning: Follow all laser safety procedures. Laser must be blocked or switched off before beginning this procedure.





Caution: Do not exceed the power/energy density limits for the pyroelectric probe as defined in the probe's data sheet.

1. Place the pyroelectric detector in the path of the laser beam in such a way that the beam will strike the center of the probe surface when power is restored.
2. Connect the detector to the EPM1000 rear panel. In most cases, this connection will be the Pulse In connector, but in such cases as the J9-0660 pyroelectric probe, this will be the 25-pin Smart Probe connector.
3. Turn the EPM1000 on. If the EPM1000 isn't in normal mode, place it into normal mode by pressing .
4. Program the EPM1000 with the correct responsivity by pressing   and entering the value using the numeric entry keys. The proper responsivity value should be printed on a label attached to the probe. Note that the EPM1000 expresses responsivity as Volts/Joules, so if the probe responsivity is in other units (such as V/mJ), it must be converted before entry.
5. Switch the laser on or unblock the beam. Verify proper beam alignment on the probe surface.
6. Adjust the range by pressing  or  until the **TRG** annunciator activates and an energy reading appears on the digital display. Note that at lower frequencies, the **TRG** annunciator will indicate each valid pulse by flashing on once, but at higher frequencies, it is activated continually as long as valid pulses arrive at the input. A display reading of OL indicates the selected range is too low.



Modes

Normal Mode Use Normal Mode to make most measurements. The EPM1000 displays continuous live updates of incoming probe data in Joules, Volts, Watts, or Hertz for pyroelectric/silicon probes and data in Volts or Watts for thermopile probes.

If the frequency of incoming pulses exceeds the display refresh rate (3 Hz), then some data will not appear on the LCD, but it will be saved in the EPM1000's buffer, if the instrument has been programmed to store the data.

The EPM1000 is in Normal Mode only when **AUTO**, **AVG**, **MIN**, **MAX**, and **DEV** are all not visible. Place the EPM1000 into Normal Mode by pressing , , , or .

Auto Mode Use Auto Mode to automatically seek the most appropriate range for any given input. Auto Mode is particularly useful when the input signal varies greatly during a sampling, because the EPM1000 is constantly seeking the best display range at each pulse. The EPM1000 can autorange while measuring Joules, Volts, or Watts, and the measurement unit can be changed while in Auto Mode, but the trigger source must always be external. The EPM1000 will not autorange from an internal trigger.



While in Normal Mode, measuring Joules, Volts, or Watts, press  to set the EPM1000 in Auto Mode. The next pulse is used to determine the proper range and while the EPM1000 is seeking this range, the **AUTO** annunciator blinks. The annunciator stops blinking and locks on when the EPM1000 has located the proper range. The next pulse will use this new range. Press  again to deactivate Auto Mode.

Note that for best results, manually set the EPM1000 to its highest range before activating Auto Mode.

Average Mode Use Average Mode to reduce pulse-to-pulse (or reading-to-reading for thermopile probes) variation on the EPM1000 display. While in Average Mode, the EPM1000 reports the arithmetic mean of some number of consecutive samples. This number, the Average Batch Size, can be any integer from 2 to 99. Although only the resulting mean is displayed on the LCD, the EPM1000 can be programmed to save each peak or reading in its internal buffer for later transfer to a host computer. After reporting the mean value, the EPM1000 resets its counter and begins sampling the next batch. No counts are lost in the process. The previous value remains onscreen until the next value is calculated.

**Average Mode
(Continued)**

Average Mode will function while measuring Joules, Volts, or Watts, but changing measurement units will reset the EPM1000 to Normal Mode.





Press  to enter Average Mode. The LCD will display a countdown as the EPM1000 counts its first batch, but thereafter will only display calculated means. The **AVG** annunciator will blink while the EPM1000 is in Average Mode. Press  again to exit Average Mode.

Statistics Mode

Use Statistics Mode to measure statistical qualities of a predetermined number of samples. This number, the Statistics Batch Size, can be 0 or any number from 2 to 9999. The EPM1000 can be programmed to stop after taking a single batch (Manual Restart Mode), or continue sampling a new statistical batch (Automatic Restart Mode).

Statistics Mode will function while measuring Joules, Volts, or Watts, but changing units during a batch will reset the unit to Normal Mode.

A Statistics Batch Size of 0 sets the EPM1000 to continuously collect data, comparing values on the fly and updating the Minimum and Maximum values. During this continuous collecting, the EPM1000 does not collect or display the Arithmetical Mean or the Standard Deviation.

Press  to enter Statistics Mode. Use the  or  keys to sequence through the four statistical values. LCD annunciators indicate which value is displayed, **AVG** for the Mathematical Mean (or Average) of the batch, **MIN** for the Minimum value, **MAX** for the Maximum value, and **DEV** for the Standard Deviation. Press  again to exit Statistics Mode.





Set the EPM1000 to Normal Mode before changing any settings.





Settings

System Settings

Audible Beeper

The EPM1000 generates an audible tone during certain error conditions such as an input overrange or when the thermopile temperature exceeds 100°C.





To turn the Beeper option on, press    .

To turn the Beeper off, press    .

System Settings (Continued)







Average Batch Size

The number of samples in the EPM1000's Average Batch Size can be any value from 2 to 99.

To change the quantity, press  . The LCD will indicate the current value. For example, a value of 57 samples looks like . Change the value directly with the numeric Entry Keys. Increment or decrement the value by one by pressing  or , respectively.

Display Backlight







The EPM1000 LCD and Analog Meter can be illuminated for viewing in a dim environment.







To turn the Backlight on, press      . The Backlight should immediately turn on.







To turn the Backlight off, press      . The Backlight should immediately turn off.

Display Speedup (for Thermopile only)

For a detailed description of the Display Speedup feature, see *Understanding the EPM1000 Speedup Feature*.







To enable Display Speedup, press   . Press  or  until the LCD reads . Finish the action by pressing .

To disable Display Speedup, press      .

To set Display Speedup to Selective, press      .

Factory Defaults

For a complete list of the EPM1000's factory defaults, please see the *Specifications* section.

Reprogram the EPM1000 with its factory default values by pressing       . The instrument will immediately reset with the new settings.

System Settings
(Continued)

Line Frequency

The EPM1000 uses a 12-bit analog-to-digital converter for thermopile data. This converter must be programmed to reject the local AC line frequency for greatest accuracy. Two rejection frequencies are programmed into the EPM1000, 50Hz and 60Hz.

To reject 50Hz frequencies, press .

To reject 60Hz frequencies, press .

Responsivity (Pyroelectric)

The Pyroelectric Responsivity Value is the conversion factor, converting probe voltage to energy in Joules. The simple equation describing this is: Energy in Joules = Probe Voltage/Responsivity. The probe responsivity is typically printed on the probe label. Note that if the probe responsivity is expressed in some fractional unit (for example, Volts/millijoule), then the stated responsivity must be multiplied accordingly

To change the pyroelectric responsivity, press . The current pyroelectric responsivity will be displayed. For example, if the current responsivity is 2200 V/J, then the EPM1000 LCD will read 2.200 ^{±3}. Use the and keys to change the exponent and exponent sign. Use the Numeric Entry Keys to change the decimal value. When complete, press to complete the action. The EPM1000 will not permit an invalid responsivity.

Compensate for optical attenuation by adjusting the responsivity accordingly. For example, if a detector's responsivity is 1.53 and the beam passes through a 50% optical attenuator before striking the probe, set the responsivity to 0.765 or 7.65 x 10⁻¹ (1.53 x 0.5).

Responsivity (Thermopile)

The Thermopile Responsivity, like the pyroelectric responsivity, is a conversion factor, but to Watts instead of Joules. For most probes, the EPM1000 will automatically read the thermopile responsivity from the probe EEPROM, but sometimes the thermopile responsivity must be changed manually.



To change the thermopile responsivity, press . The current thermopile responsivity will appear on the LCD. As with the pyroelectric responsivity, press or to change the exponent and exponent sign. Change the decimal part using the Numeric Entry Keys. Finish by pressing . As with the pyroelectric responsivity, the EPM1000 refuses to accept an invalid value.



System Settings (Continued)

Statistics Batch Restart Mode

The EPM1000 handles the end of a statistical batch in one of two different ways. In Automatic Restart Mode, at the end of a batch, the EPM1000 automatically begins collecting the next batch. The calculated statistical values are displayed on screen until the new batch has been collected. In Manual Restart Mode, at the end of a batch, the EPM1000 ignores additional incoming data and displays the finished batch's statistical data until the EPM1000 is reset manually by pressing the  key or via the remote command: **CH STAT START**.

To change the Restart Mode, press . The LCD will display the Statistics Batch Size and the Restart Mode. For example, if the EPM1000 was set to a 1000-pulse Batch Size and Automatic Restart, then the LCD would read **1000_{PR}**.

Use the  and  keys to toggle the restart mode from Automatic to Manual.



Press  to accept the selection or  to cancel it.

Statistics Batch Size

Program the EPM1000 to collect a sample size from 2 to 9999 samples.

Press  to change the Batch Size. The LCD will display the statistics batch size and the restart mode. For example, a batch size of 6126 with manual restart appears as **6 126_{MR}**.

Use the Numeric Entry Keys to change the value of the batch size.







Press  to accept the new value or  to cancel the action.

Wavelength Compensation (for Thermopile only)

Sometimes a probe calibrated for one laser wavelength must be used to measure laser energy of another wavelength. Because of differing absorptive characteristics, the results are often incorrect.

The EPM1000 can be programmed to compensate for such a change in wavelength.

To activate Wavelength Compensation, press   .



To change the compensation value, press  . Use the numeric entry keys to change the decimal value and the  and  keys to select μm or nm . Press  at any time while entering data to restore the initial value. Press  to complete the action.



To deactivate Wavelength Compensation, press   .

Trigger Settings

Trigger Holdoff





The Trigger Holdoff determines how long the EPM1000 waits after receiving a valid trigger before resetting the triggering circuit. This avoids false triggers from a noisy pulse tail (See *Understanding the EPM1000 Trigger*). The Trigger Holdoff can be set for 0 to 49 ms.

Set the Trigger Holdoff by pressing   .

Press  or  to increment or decrement through the possible delay values or use the Numeric Entry Keys to enter a value directly. The EPM1000 will not permit an invalid value. Press  to complete the action.



Trigger Level

The EPM1000 internal trigger level can be set for as low as 2% of full scale and as high as 20% of full scale. Noisy environments require higher trigger levels.

To set the EPM1000's trigger level, press . Press  or  to increment and decrement through the possible level values or use the Numeric Entry Keys to enter a value directly. Press  to complete the action.

Trigger Source

The EPM1000 can be set to trigger on some selected percentage of the current range (internal trigger) or on an external signal, applied to the TRIG IN connector. At any time while setting the trigger source, pressing  cancels the action and restores the previous value.

To set the EPM1000's trigger source, press  .

For an internal trigger, press  until the EPM1000 LCD reads $\uparrow T$.

For an external, positive-edge trigger, press  until the EPM1000 LCD reads $\times T$.









For an external, negative-edge trigger, press  until the EPM1000 LCD reads $\bar{\times} T$.

Press  to complete the action.





Communications Settings





IEEE-488 Address

Set the EPM1000 IEEE-488 address to any value from 1 to 31. Although the EPM1000 can use address 0, this is not recommended, as the IEEE-488 bus expects the instrument at address 0 to be a Controller.

Press      to set the IEEE-488 address. The EPM1000 LCD will display the current address. For example, an address of 12 appears as 12_{Hd} . Use the  or  keys to increment or decrement the current address or the Numeric Entry Keys to select an address more quickly. Press  to complete the action.









IEEE-488 Enable/Disable

To enable the EPM1000's IEEE-488 port, press     .





To disable the port, press  . Press  until the LCD reads either 232_{ES} or $0FF_{\text{ES}}$. The former activates the RS-232 interface, which automatically disables the IEEE-488 interface and the latter deactivates both communications interfaces. Press  to complete the action.











RS-232 Baud Rate

The RS-232 interface requires a baud rate selected for the EPM1000 that matches the baud rate of the host machine. The EPM1000 supports six different baud rates: 1200, 2400, 4800, 9600, 19200, and 38400.

To change the RS-232 baud rate, press  . Press  or  until the display reads 232_{ES} . Press . The current baud rate should appear on the LCD. For example, if the current baud rate is 9600, then 9600_{BR} appears on the LCD. Use the  and  keys to select the desired baud rate, then press  to complete the action.

RS-232 Enable/Disable











To enable the RS-232 communications port, press  . Press  or  until the LCD reads 232_{ES} , then press  to complete the action.

To disable the RS-232 port, activate the IEEE-488 port by pressing     . The RS-232 communications port will also be deactivated if both ports are deactivated. Deactivate both ports by pressing     .

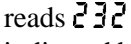
Communications Settings
(Continued)











RS-232 Parity

The RS-232 communications port of the EPM1000 has three possible settings for the parity bit: even, odd, or none.

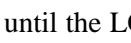
To set the parity, press   and then  or  until the LCD reads  ϵ s. Then press  . The current parity setting will be indicated by the alphanumeric display. Odd, even, and no parity appear as $P\bar{O}$, PE , and $P\bar{N}$, respectively. Use the  and  keys to select the desired parity and press  to complete the action.

RS-232 Stop Bits

The RS-232 data stream from the EPM1000 can be set to contain one or two stop bits.

Set the number of stop bits by pressing   and then  or  until the LCD reads  ϵ s. Then press   . The LCD indicates the current number of stop bits. For example, one stop bit is indicated as t_{5B} . Use the  and  keys to select the desired number of stop bits and press  to complete the action.

Programming

Connection Methods

The EPM1000 has been designed to use one computer interface at a time. Before attempting to communicate with the EPM1000 via either the RS-232 interface or the IEEE-488 interface, be sure the interface has been activated (see *Operation -- Settings -- Communication Settings*). Verify that all computer host communication settings match the EPM1000 settings (IEEE-488 address, RS-232 baud rate, etc.).

The EPM1000 will only transmit in response to a query command. It will not respond to set commands. For example, the EPM1000 will transmit a response to `ch stat bat ?`, but not to `ch stat bat 100`.

The EPM1000 activates the **REM** annunciator and disables the front panel controls while it processes a remote command. During IEEE-488 communication, the EPM1000 stays in this mode. To return the EPM1000 to local control, send a ***RST** to the EPM1000 or a **loc** command to the IEEE-488 bus. During serial communication, when the EPM1000 has completed the remote command, the **REM** annunciator is deactivated and control returned to the front panel.

Commands

Commands will function as described with either the RS-232 or IEEE-488 interface.

If the EPM1000 receives a command it does not know or cannot process, no action will occur, unless Communication Error reporting is activated, in which case, the EPM1000 will reply with the error message:
Unrecognized SCPI command: <invalid command> ?.

Although capitalization indicates a required substring of the command, command case isn't relevant. Commands can be separated by a space, a colon (:), or a tab. Commands preceded by a semicolon (;), an asterisk (!), or a pound sign (#) are read as comments by the EPM1000 and ignored.

Command parameters separated by a vertical slash are exclusive choices. For example, **CHannel UNITS <?|VOLts|JOUles|WATts|HZ>** means that `ch units vol` is a valid command or `ch units jou`, but not `ch units vol jou`. Command parameters separated by a comma are non-exclusive choices. For example, **CHannel STATistics SEND <AVG,DEV,MIN,MAX>** means that `ch stat send avg` is valid, as is `ch stat send avg min max`.

The EPM1000 will not buffer commands, so commands received while the EPM1000 is processing a previous command will be ignored. 300 ms is enough time for the EPM1000 to recover from most commands.

Audible Beeper Set or query the status of the Audible Beeper option.

Command Form

SYSTEM OPTION AUDIO <?|ON|OFF>

Examples

Input	Response
syst opt aud off	none
syst opt aud ?	SYSTEM: OPTION: AUDIO OFF

Average Batch Size Set or query the Average Mode Batch Size of the EPM1000.

Command Form

CHANNEL AVERAGE BATCH_SIZE <?|2..99>

Examples

Input	Response
ch aver bat 42	none
ch aver bat ?	CHAN A: AVERAGE: BATCH_SIZE 42

Backlight Set or query the status of the EPM1000's backlight.

Command Form

SYSTEM OPTION BACKLIGHT <?|ON|OFF>

Examples

Input	Response
syst opt bac off	none
syst opt bac ?	SYSTEM: OPTION: BACKLIGHT OFF

Channel Store/Recall Set the EPM1000 to store certain instrument attributes in or retrieve those attributes from a numbered memory location. The stored attributes are Average Batch Size, Display Speedup, Line Frequency, Pyroelectric Rv, Range, Statistics Batch Size, Statistics Restart Mode, Trigger Holdoff, Trigger Level, Trigger Source, and Units. Memory locations 1, 2, 3, or 4 are available.

Command Form

CHANNEL MEMORY <STORE|RECALL> <1|2|3|4>

Example

Input	Response
ch mem store 1	none
ch mem recall 1	none

Communications Error Set the EPM1000 to echo back invalid commands.

Command Form

COMMunication ERROR <ON|OFF>

Examples

Input	Response
comm error on	none
syst opt bak off	Unrecognized SCPI command: syst opt bak off

Display Current Reading Query the EPM1000 for the data currently displayed on the LCD.

Command Form

CHannel QUERY

Examples

Input	Response
ch query	CHAN: QUERY: 227.4 mV

Identification Query the EPM1000 for identifying information, such as firmware revision date, model number, etc.

Command Form

***IDN?**

Examples

Input	Response
*idn?	Molelectron Detector, Inc. EPM1000 Ver G3.18 26-Aug-96†

† Actual reading will vary, depending on installed firmware.

IEEE-488 Address Set or query the IEEE-488 address of the EPM1000. The EPM1000 must be reset for this command to take effect.

Command Form

COMMunication GPIB ADDRESS <?|0..31>

Examples

Input	Response
comm gpib addr 12	none
comm gpib addr ?	COMM: GPIB: ADDRESS 12

Line Frequency Set or query the EPM100's line frequency option.

Command Form

SYSTEM OPTION LINE <?|50HZ|60HZ>

Examples

Input	Response
syst opt line 60hz	none
syst opt line ?	SYSTEM: OPTION: LINE 60HZ

Operating Mode Set or query the EPM1000's current Operating Mode.

Command Form

CHANNEL OPERATING_mode <?|NORMAL|AVERAGE|STATISTICS>

Examples

Input	Response
ch oper stat	none
ch oper stat ?	CHAN A: OPER STATISTICS

Output Buffer Set or query the disposition of new data when the output buffer has reached the level specified by **output depth**. In Fixed mode, the new data is simply discarded. In Circular mode, the oldest data point is discarded and replaced with the newest data point.

Command Form

OUTPUT BUFFER <?|FIXED|CIRCULAR>

Examples

Input	Response
out buf fixed	none
out buf ?	OUTPUT: BUFFER FIXED

Output Continuous Set the EPM1000 to either continuously transmit data or store data in its internal buffer. To continuously transmit data via RS-232, the DTR line must remain asserted. If storing data, the EPM1000 will transmit all of its data upon receiving an **output dump** command.

Command Form

OUTPUT CONTINUOUS <ON|OFF>

Example

Input	Response
out cont on	none

Output Depth Set or query the depth of the EPM1000 buffer in bytes, any value from 1 to 4095.

Command Form

OUTput DEPth <?|1..4095>

Examples

Input	Response
out dep 1000	none
out dep ?	OUTPUT: DEPTH 1000

Output Dump Query the EPM1000 buffer contents, but only when **out cont** is off. Upon receiving an **out dump** command, the EPM1000 immediately flushes the contents of its buffer out the selected communications port. **out form** dictates the nature of the data that is transmitted. Pulse information received by the EPM1000 during the execution of an **out dump** is stored within the EPM1000 buffer.

Command Form

OUTput DUMP

Examples

Input	Response
out dump	<listing of data>

Output Format Set or query the format which the EPM1000 uses to transmit data. Ordinary device queries are always answered by the EPM1000 in ASCII -- this command determines the format of pulse data only. The three forms are Binary, ASCII, and ASCII+.

Binary

The most compact form of data storage. In this mode, the EPM1000 transmits 8-bit values, which decode to one of the following three types of data: Status Byte, Data High Byte, or Data Low Byte.

Status Bytes determine such qualities as range, units, and type of data. Status Bytes only appear in the data stream when one or more of those data properties changes or at the beginning of the data transmission. Status Bytes will always be followed by other Status Bytes or by a Data High Byte. Bit 7 of a Status Byte will always be 0.

Output Format
(Continued)

Bit	7	6	5	4	3	2	1	0
Mnemonic	0	Chan	Type	d4	d3	d2	d1	d0

Figure 9: Status Byte Map

Status Bytes decode as follows:

- Bit 7 Always 0

- Bit 6 Channel
 0 = Channel A
 1 = Channel B (not used on EPM1000)

- Bit 5 Information Type
 0 = Range Information
 1 = Unit Information

- Bits 4-0 (If Range Information) Range
 00000 = 10^0
 00001 = 10^1
 00010 = 10^2
 ...
 01110 = 10^{14}
 01111 = 10^{15}
 10000 = not used
 10001 = 10^{-15}
 10010 = 10^{-14}
 ...
 11110 = 10^{-2}
 11111 = 10^{-1}

- Bits 4-2 (If Unit Information) Type of Data
 000 = Pulse Measurement
 001 = Statistical Batch Mean (Average) Measurement
 010 = Statistical Batch Standard Deviation Measurement
 011 = Statistical Batch Maximum Measurement
 100 = Statistical Batch Minimum Measurement
 101 = Command in Process
 110 = Command Completed
 111 = End of Data

- Bits 1-0 (If Unit Information) Units
 00 = Joules
 01 = Volts
 10 = Watts
 11 = Hertz

Output Format (Continued)

Data Bytes contain the 12-bit value of the reading. They are always in the order: Data High Byte, Data Low Byte. In the Data High Byte, bits 7 and 6 are always 1 and 0, respectively. Bits 5-0 are bits 11-6 of the Data Value. In the Data Low Byte, bits 7 and 6 are always both 1 and bits 5-0 are bits 5-0 of the Data Value. Append the two pieces of the Data Value, convert to decimal, add leading zeroes if necessary to complete the 4-digit decimal value, and add the implied decimal point. Use the most recent Status Byte values to complete the reading.

Bit	7	6	5	4	3	2	1	0
Meaning	1	0	d11	d10	d9	d8	d7	d6

Figure 10: Data High Byte Map

Bit	7	6	5	4	3	2	1	0
Meaning	1	1	d5	d4	d3	d2	d1	d0

Figure 11: Data Low Byte Map

For example, an EPM1000 dumps its buffer. The following data is transmitted: **38 21 00 A6 C3 A6 CA 3C**. Translated:

```

38 = 0011 1000
      Status Byte, CH A, Unit Information, "Command Completed"
21 = 0010 0001
      Status Byte, CH A, Unit Information, "Pulse Measurement", "Volts"
00 = 0000 0000
      Status Byte, CH A, Range Information, 100
A6 = 1010 0110
      Data High Byte: 100110
C3 = 1100 0011
      Data Low Byte: 000011
      Complete data value: 100110 000011 = 2435
      Interpreted reading is 2.435 x 100 Volts.
A6 = 1010 0110
      Data High Byte: 100110
CA = 1100 1010
      Data Low Byte: 001010
      Completed data value: 100110 001010 = 2442
      Interpreted reading is 2.442 x 100 Volts.
3C = 0011 1100
      Status Byte, CH A, Unit Information, "End of Data"
  
```

ASCII

A form of transmission used in A/D debugging and calibration -- rarely used in the field. Data are transmitted in raw A/D counts, followed by a unit designator: **2146V**, **1864V**, **1600V**, **1366V**, etc. The decimal point after the first digit is still implied and the leading zeroes are blanked, so a reading such as **687V** would indicate a pulse height of 0.687V

**Output Format
(Continued)**

ASCII+

A commonly used form of data transmission, most easily readable. Data is indicated using scientific notation and units are included. For example, **0.687E+00V**.

When multiple values are transmitted (such as statistical data), the values are separated by a comma. To avoid confusion, data headers should be utilized when transmitting multiple values (see *Programming -- Commands -- Statistics Send*). An example of multiple values with headers is: **AVG=0.950E+00V,DEV=0.001E+00V**.

Command Form

OUTputFORMat <?|BINary|ASCII|ASCII+>

Examples

Input	Response
out form bin	none
out form ?	OUTPUT: FORMAT BINARY

Probe Type

Query the EPM1000 to determine the type of probe attached. In the case of a PowerMax[®] probe, the EPM1000 will also return the head code in hexadecimal notation.

Command Form

CHan TYPE ?

Example

Input	Response
ch type ?	CHAN A: TYPE PYRO

Range, Current

Set or query the EPM1000's current range. Example range arguments include **300mv**, **30mj**, **3j**, etc.

Command Form

CHan RANGE <?|range argument>

Example

Input	Response
ch range 10V	none
ch range ?	CHAN A: RANGE 10V

Range, Maximum/Minimum Query the EPM1000's maximum or minimum possible range with the current units, responsivity, head, etc.

Command Form

CHan RANGE <MAX|MIN> ?

Example

Input	Response
ch range max ?	CHAN A: RANGE MAX=10V
ch range min ?	CHAN A: RANGE MIN=1mV

Reset Immediately reset the EPM1000.

Command Form

***RST**

Example

Input	Response
*rst	<unit resets>

Responsivity Set or query the pyroelectric or thermopile responsivity of the EPM1000. Express the value in decimal or scientific notation.

Command Form

CHan RESPonsivity <THERmopile|PYROelectric> <?|value>

Examples

Input	Response
ch resp pyro 2200	none
ch resp pyro ?	CHAN A: RESP: PYRO 2.200E+03
ch resp pyro 1.331e5	none
ch resp pyro ?	CHAN A: RESP: PYRO 1.331E+05

RS-232 Baud Rate Set or query the RS-232 baud rate of the EPM1000.

Command Form

COMMunication RS232 BAUD <?|1200|2400|4800|9600|19200|38400>

Examples

Input	Response
comm rs232 baud 2400	none
comm rs232 baud ?	COMM: RS232: BAUD 2400

RS-232 Parity Set or query the RS-232 parity bit setting of the EPM1000.

Command Form

COMMunication RS232 PARity <?|ODD|EVEN|NONE>

Examples

Input	Response
comm rs232 par even	none
comm rs232 par ?	COMM: RS232: PARITY EVEN

RS-232 Stop Bits Set or query the number of stop bits the EPM1000 injects into the communications stream.

Command Form

COMMunication RS232 STOPbits <?|1|2>

Examples

Input	Response
comm rs232 stop 2	none
comm rs232 stop ?	COMM: RS232: STOPBITS 2

Self Test Instructs the EPM1000 to perform a self-test and return the result.

Command Form

***TST ?**

Example

Input	Response
*tst ?	PASS

Speedup Set or query the status of the EPM1000 Display Speedup function.

Command Form

SYSTEM OPTION SPEEDUp <?|ON|OFF|SElective>

Examples

Input	Response
syst opt speed off	none
syst opt speed ?	SYSTEM: OPTION: SPEEDUP OFF

Statistics Batch Size Set or query the batch size in statistics mode. As with setting the batch size from the front panel, setting a quantity of 0 results in continuous statistical sampling. Setting this value automatically resets the EPM1000's statistical batch.

Command Form

CHan STATistics BATch_size <?|0|2..9999>

Examples

Input	Response
ch stat bat 6126	none
ch stat bat ?	CHAN A: STAT: BATCH_SIZE 6126

Statistics Restart Mode Set or query the EPM1000's action at the end of a statistical batch. Manual requires a restart signal, such as **ch stat start**, automatic will begin a new batch immediately upon logging the data from the previous batch.

Command Form

CHan STATistics MODE <?|MANual|AUTOMATIC>

Examples

Input	Response
ch stat mode auto	none
ch stat mode ?	CHAN A: STAT: MODE AUTO

Statistics Send Set or query the values transmitted by the EPM1000. Although they can be specified in any order, they will be transmitted only in the following order: AVG, DEV, MIN, MAX. Include headers to add an identifying string (such as AVG=) to the front of each piece of data.

Command Form

CHan STATistics SEND <?|AVG|DEV|MIN|MAX|HEADers>

Examples

Input	Response
ch stat send avg min max head	none
ch stat send ?	CHAN A: STAT: SEND: AVG MIN MAX HEADERS

Statistics Start Terminates the current statistical batch and starts a new one.

Command Form

CHan STATistics START

Examples

Input	Response
ch stat start	<batch restarts>

Trigger Level Set or query the trigger level of the EPM1000. Values accepted are 2 through 20.

Command Form

CHan TRIGgering LEVel <?|2..20>

Examples

Input	Response
ch trig lev 18	none
ch trig lev ?	CHAN A: TRIG: LEVEL 18

Trigger Source Set or query the EPM1000 trigger source.

Command Form

**CHan TRIGgering SouRCe
<?|INTernal|EXTernalPOSitive|EXTernalNEGative>**

Examples

| Input | Response |
|---------------------------|------------------------------------|
| ch trig src extneg | none |
| ch trig src ? | CHAN A: TRIG: SOURCE EXTNEG |

Units Set or query the EPM1000 measurement units.

Command Form

CHan UNITS <?|VOLts|JOUles|WATts|HZ>

Examples

| Input | Response |
|---------------------|-----------------------------|
| ch units jou | none |
| ch units ? | CHAN A: UNITS JOULES |

Zero In thermopile mode, this command sets the current probe input voltage as a zero baseline value. While taking a statistics measurement, the EPM1000 will reset the batch upon receiving this command.

Command Form

CHan ZERO

Examples

Input

ch zero

Response

**<batch resets/
thermopile zeroes>**

Programming Example

The following example shows the necessary commands to set the EPM1000 to collect a statistical batch of 100 samples from a 1kHz laser. The probe responsivity is 220 V/J. The binary data are stored in the EPM1000's buffer until download via the out dump command. The buffer depth has been set to the maximum value to allow the greatest time between data dumps.

```

ch units jou           Sets the EPM1000 to measure Joules
ch resp pyro 220     Pyroelectric responsivity to 220 V/J
ch trig src int      Trigger source: internal
ch trig lev 8        Trigger level: 8%
out cont off         Deactivate continuous output
out dep 4095         Buffer depth 4095 bytes
ch range 30mj        Range 30mJ
out form ascii+      Set output format to ASCII+
ch oper stat         Set EPM1000 to Statistics Mode
ch stat bat 100      Statistics batch size 100
ch stat mode auto    Automatic restart at the end of a batch
ch stat send min max avg dev head  Transmit all values
  
```

The following illustration shows a small LabVIEW® VI (Virtual Instrument) diagram which programs an EPM1000 with the above commands. It expects an EPM1000 on the IEEE-488 bus at address 5. Each command is separated by 300 milliseconds to avoid a command being lost while the EPM1000 is processing a previous command.

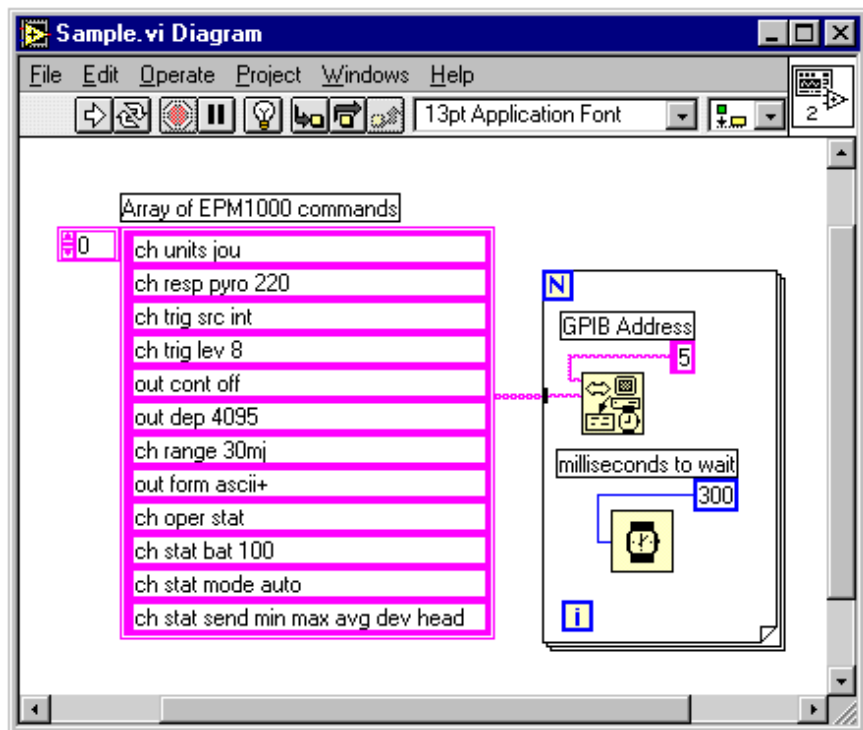



Figure 12: LabVIEW® diagram of simple application to program an EPM1000.

Maintenance, Service, & Calibration

Troubleshooting

| | |
|---|---|
| <i>The EPM1000 does not respond to anything, the screen is dark.</i> | Verify the power cord is plugged securely to the back of the EPM1000 and that the AC socket is powered. Check the fuse and replace if necessary (see <i>Maintenance , Service, & Calibration -- Fuse Replacement</i>) |
| <i>The EPM1000 is on, but no reading occurs at a laser pulse.</i> | Properly align the probe in the beam. Verify the probe is connected to the Pulse In or Smart Probe connector. If the trigger source (see <i>Operation -- Operations Settings -- Trigger Settings -- Trigger Source</i>) is external, be sure an actual trigger pulse is applied to the Trigger In connector. If the EPM1000 is expected to extract a trigger from the incoming laser pulse, set the trigger source for internal. Lower the trigger level (see <i>Operation -- Operations Settings -- Trigger Settings -- Trigger Level</i>). Lower the EPM1000's range. |
| <i>The EPM1000 ignores an attached PowerMax® or other thermopile probe.</i> | Verify the probe is connected securely. Verify the PowerMax® function is enabled by pressing  . Likewise, disable the function by pressing  . |
| <i>The EPM1000 ignores an attached pyroelectric/silicon probe.</i> | If the EPM1000 senses a PowerMax® thermopile probe upon startup, it will ignore pyroelectric/silicon probe input. Either disconnect the PowerMax® probe or deactivate it using the method described above. |
| <i>Thermopile output appears noisy once the curve levels off.</i> | Either deactivate the display speedup (see <i>Operation -- Operation Settings -- System Settings -- Display Speedup</i>) or set it to selective mode. |
| <i>The EPM1000 refuses to acknowledge commands sent via the IEEE-488 interface.</i> | Verify the IEEE-488 port has been activated (see <i>Operation -- Operation Settings -- Communications Settings -- IEEE-488 Enable/Disable</i>). Verify the EPM1000 IEEE-488 address matches the host computer's address. Verify the cable is securely attached to both devices. Verify that other IEEE-488 devices can be used on the same bus. |
| <i>The EPM1000 refuses to acknowledge commands sent via the RS-232 interface.</i> | As above, verify the RS-232 option on the EPM1000 has been activated (see <i>Operation -- Operation Settings -- Communications Settings -- RS-232 Enable/Disable</i>) Verify the host computer has selected the correct COM port address. Verify the cable is connected and in good condition. If the cable has become disconnected, the COM port may have to be reinitialized. Verify the COM port works with other devices. Add a CR (Carriage Return, ASCII 13) to the end of a command string. |
| <i>The <code>ch units ?</code> command returns the string <code>CHAN A: UNITS ?</code>.</i> | The EPM1000 may be in the middle of collecting the first of a series of statistical batches. Until the first batch is completed, a units query returns the above response. Either query units before entering statistics mode or wait until the first batch has been taken. |

Troubleshooting (Continued)

- Some commands in a string of commands are not always implemented.* Be sure to allow sufficient time for the EPM1000 to complete a command before sending the next one. 300 ms is ideal, although some commands will execute in less time.
- The EPM1000 won't save anything in its output buffer or dump its output buffer.* If the EPM1000 is set for continuous output, the buffer will not contain data and the **out dump** command will be ignored. Deactivate the continuous output with **out cont off**.
- The buffer contains extra, incorrect pulse data.* Switching ranges on an EPM1000 can cause a trigger, which activates the A/D converters. The resulting data is stored in the buffer just like real data. Avoid this by keeping the EPM1000 set to external trigger whenever possible. This only occurs when the EPM1000 trigger source is internal.
- When collecting a statistical batch, the mean value is much lower than expected.* Raise the trigger level as high as possible without missing pulses. A trigger level that is too low will trigger on and collect noise, which contaminates the batch.
- When set to a low range, the EPM1000 doesn't trigger on large pulses.* When determining a proper range for an unknown signal, always start at the highest possible range and work downward from there. Avoid starting at a low range and working up, as this usually results in an overload condition. Likewise while using the Autorange function, begin by setting the EPM1000 into its highest range.
- The EPM1000 indicates a value, but there are no pulses arriving.* The EPM1000 will hold the last peak value measured, even if the pyroelectric/silicon probe has been disconnected. Press the corresponding unit key to clear the display.
- The EPM1000 triggers for pulses which don't exist and the false value are very low.* The Trigger Holdoff may be set too low, causing the EPM1000 to trigger on the tail of the most recent pulse. See *Operation -- Operation Settings -- Trigger Settings -- Trigger Holdoff* and set the Trigger Holdoff for a value high enough for the pulse tail to drop below the trigger threshold.

Fuse Replacement

The EPM1000 has no user-serviceable parts other than the replaceable fuse located on the rear panel. Replace the fuse by using a small flat-head screwdriver to carefully pry the fuse holder from the power entry module. Use only a 240VAC/1A fast-blow fuse. Locate a spare fuse in the removable fuse holder.

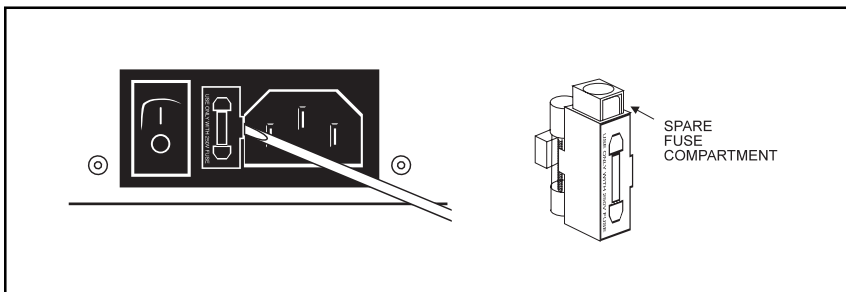

Figure 13: Removing the EPM1000 fuse, and the spare fuse compartment.



Caution: If the EPM1000 blows two or more fuses in a short period of time, turn the unit off, disconnect it from the AC supply, and contact Moletron Detector, Inc.

Instrument Calibration and Service

To maintain optimum NIST traceable performance, return the EPM1000 to Moletron Detector, Inc., for annual calibration and maintenance.

To prepare and ship an EPM1000 to Moletron Detector, Inc.:

1. Call Moletron for a Return Material Authorization (RMA) number.
2. Attach a tag to the EPM1000 indicating the owner's name and address, the person to contact, the serial number, and the RMA number.
3. Wrap the EPM1000 with polyethylene sheeting or equivalent material.
4. If the original packing material and carton are not available, obtain a corrugated cardboard shipping carton with inside dimensions at least 15 cm (6 in) taller, wider, and deeper than the EPM1000. The shipping carton must be constructed of cardboard with a minimum 170 kg (375 lb) test strength. Cushion the unit in the shipping carton by tightly packing dunnage or urethane foam on all sides between the carton and the EPM1000. Allow 7.5 cm (3 in) on all sides, top, and bottom.

**Instrument
Calibration and
Service
(continued)**

5. Seal the shipping carton with shipping tape or an industrial stapler.
6. On the outside of the package, clearly print the RMA number.

Specifications

Electrical/Mechanical

| | |
|---|---|
| Display | <ul style="list-style-type: none"> • Four numeric digits with polarity sign. • Two alphanumeric characters • Annunciators for statistical functions, trigger, and communications • Backlight on/off switchable |
| Ranges (Ranges are limited to 5 or 6 decades depending on probe type) | <ul style="list-style-type: none"> • Energy 1 pJ to 10 J in 28 ranges • Power 1 mW to 10 kW in 15 ranges • Frequency 0.1 to 500 Hz (for pyroelectric/silicon probes only) • Volts 2 mV to 30 V (for pyroelectric/silicon probes only) • Volts 200 μV to 1 V (for thermopile probes) |
| Resolution | <ul style="list-style-type: none"> • Energy 1:3000 of full scale • Power 1:3000 of full scale • Frequency 0.1 Hz • Volts 10 μV |
| Maximum Rep Rate | <ul style="list-style-type: none"> • 1000 Hz |
| Linearity | <ul style="list-style-type: none"> • $\pm 1\%$ |
| A/D Digital Resolution | <ul style="list-style-type: none"> • 12 bit |
| Input Impedance | <ul style="list-style-type: none"> • 1 MΩ (50 Ω output probes require a feedthrough terminator) |
| Noise Equivalent Voltage (NEV) | <ul style="list-style-type: none"> • 50 μV typical |
| Analog Output | <ul style="list-style-type: none"> • Full scale output 1.81VDC • Output Impedance 100 Ω • Minimum load 600 Ω • Update Rate 3 Hz |
| External Trigger Input | <ul style="list-style-type: none"> • Optically coupled • 100 Ω in series with LED • Rising/falling edge trigger via user control. |

Electrical/Mechanical (continued)

- | | |
|----------------------------------|--|
| Electronic Accuracy | <ul style="list-style-type: none">• Analog output $\pm 1\%$• Digital display $\pm 1\%$ |
| System Accuracy | <ul style="list-style-type: none">• Pyroelectric probe $\pm 5\%$• Thermopile probe $\pm 3\%$ (with wavelength correction) |
| Maximum Pyroelectric Pulse Width | <ul style="list-style-type: none">• 10 ms |
| Internal Trigger | <ul style="list-style-type: none">• Adjustable 2% to 20% |
| RS-232 Baud Rates | <ul style="list-style-type: none">• 38400, 19200, 9600, 4800, 2400, and 1200 |
| Power Requirements | <ul style="list-style-type: none">• 90 to 264 VAC at frequencies between 50 Hz and 60 Hz |
| Dimensions | <ul style="list-style-type: none">• 30.48 cm x 27.31 cm x 11.43 cm (12" x 10.75" x 4.5") |
| Weight | <ul style="list-style-type: none">• 1.41 kg (3.1 lbs) |

Firmware Revisions

Every EPM1000 contains two programmed chips, one for the analog board and one for the digital board. Knowing the firmware revisions of these chips is useful when calling Molelectron Detector, Inc. Press



to determine the *digital firmware revision*.

Print that number here: _____ (*digital firmware revision*)

Press  to see the *analog firmware revision*.

Print that number here: _____ (*analog firmware revision*)

Factory Defaults

| | |
|---------------------------------------|-------------------------|
| Audible Tone | On |
| Autorange | Off |
| Average Batch Size | 50 |
| Backlight | On |
| Communication Channel | Off |
| Display Speedup | Off |
| IEEE-488 Address | 00 |
| Operating Mode | Normal |
| Pyroelectric Responsivity | 2.00 V/J |
| Pyroelectric/Silicon Measurement Mode | Joules |
| Range | 2 Joules |
| RS-232 Settings | 9600, N, 1 (8-bit data) |
| Statistics Batch Size | 50 |
| Statistics Restart Mode | Automatic |
| Thermopile Compensation Wavelength | 514 nm |
| Thermopile Measurement Mode | Watts |
| Trigger Level | 5% |
| Trigger Source | Internal |

Warranted Characteristics

| | |
|----------------------------------|---|
| Power | 90-264VAC, 47-63Hz, 25VA |
| Atmospherics (Temperature) | Operating 0°C to +50°C (32°F to +122°F)
Storage -40°C to +75°C (-40°F to +167°F)
Note: Maximum operating temperature is decreased 1°C per 305 m (1000 ft) above 1525 m (5000 ft). |
| Atmospherics (Relative Humidity) | 0 to 95% at or below +30°C (+86°F)
0 to 75% from +31°C to +50°C (+87°F to +122°F) |
| Atmospherics (Altitude) | Operating 4570 m (15,000 ft)
Non-operating to 12190 m (40,000 ft) |
| Dynamics (Random Vibration) | Operating 0.31 g rms, from 5 to 500 Hz, 10 minutes each axis.
Non-operating 2.46 g rms, from 5 to 500 Hz, 10 minutes each axis. |

Warranted Characteristics (continued)

Emissions Meets or exceeds the requirements of the following standards:

- EN 50081-1 European Community Requirements
- EN 55011 Radiated Emissions Class A
- EN 50081-1 Conducted Emissions Requirements

Note: To maintain emission requirements when connecting to the serial interface, use only high-quality, double-shielded (braid and foil) cables. The cable shield must have a low impedance to the connector housings at both ends.

Susceptibility Meets or exceeds the requirements of the following standards:

- EN 50082-1 European Community Requirements
- IEC 802-2 Electrostatic Discharge, Performance Criteria B
- IEC 801-3 Radiated Susceptibility 3 V/meter from 27 MHz to 500 MHz unmodulated.
Performance Criteria: Maximum meter deviation $\pm 3\%$ of reading. Maximum LCD reading deviation $\pm 3\%$ of reading.
- IEC 801-4 Electrical Fast Transient/Burst

Index

- ***idn?**, see Identification
- ***rst**, see Reset
- ***tst ?**, see Self Test
- 50 Ω Feedthrough Terminator, 8
- 50 Ω Impedance Probes, 8
- AD**
 - Converters, 20, 40
 - Debugging/Calibration, 31
 - Digital Resolution, see Specifications, A/D Digital Resolution
- AC In Connector, 8, 9
- AC Power Supply Required to Function, 9
- Accuracy**
 - Electronic, see Specifications, Electronic Accuracy
 - System, see Specifications, System Accuracy
- Adjustment, Analog Meter Zero, 13
- Adobe® PageMaker®, 3
- Alphanumeric Display, 10, 11
- Altitude, Operating, see Warranted Characteristics, Atmospherics
- Analog Board, 44
- Analog Firmware Revision, 44
- Analog Meter, 10, 13
 - Scale, 11, 13
- Analog Out Connector, 8
- Analog Output, see Specifications, Analog Output
- Annunciators**
 - AUTO, 10, 11, 17
 - AVG, 10, 11, 18
 - AVG, 18
 - DEV, 10, 11, 18
 - MAX, 10, 11, 18
 - MIN, 10, 11, 18
 - REM, 10, 11
 - TRG, 11
 - REM, 25
- Arrow Keys, see Keys, Arrow
- ASCII Format, see Format, Data, ASCII
- ASCII+ Format, see Format, Data, ASCII+
- Audible Beeper, 18, 26
- AUTO Annunciator, see Annunciator, AUTO
- Auto Key, see Keys, Auto
- Auto Mode, see Modes, Auto
- Automatic Baseline Drift Compensation, 1
- Automatic Restart Mode, see Statistics Batch Restart Mode, Automatic
- Autorange**
 - Using, 40
 - with Pyroelectric/Silicon Probes, 12
- Average Batch Size, 17, 19, 26
 - Changing, 19
- Average Key, see Keys, Average
- Average Mode, see Modes, Average
- Average Mode, Setting the EPM1000 for, 12, 18
- AVG Annunciator, see Annunciator, AVG
- Backlight, Display, 19, 26
- Baseline, 5
- Battery Indicator, see Indicator, Battery
- Baud Rate, see RS-232 Port Baud Rate
- Binary Format, see Format, Data, Binary
- Buffer Depth, see Output Depth
 - Buffer, Extra Data In, 40
 - Buffer, see Data Buffer
- Buffering Commands, see Commands, Buffering
- Buttons, see Keys
- Cables, 39
- Calibration, 41
- Capitalization, see Case, Command
- Case, Command, 25
- Caution Condition, Defined, 2
- ch aver bat**, see Average Batch Size
- ch mem recall**, see Channel Recall
- ch mem store**, see Channel Store
- ch oper stat**, see Operating Mode
- ch query**, see Display Current Reading
- ch range max**, see Range, Maximum/Minimum
- ch range min**, see Range, Maximum/Minimum
- ch range**, see Range, Current
- ch resp pyro**, see Responsivity
- ch stat bat**, see Statistics Batch Size
- ch stat mode**, see Statistics Restart Mode
- ch stat send**, see Statistics Send
- ch stat start**, see Statistics Batch Restart Mode
- ch stat start**, see Statistics Start
- ch trig lev**, see Trigger Level
- ch trig src**, see Trigger Source
- ch type**, see Probe Type
- ch units**, see Units
- ch zero**, see Zero
- chan a: units ?**, 39
- Channel Recall, 26
- Channel Store, 26
- Clearing Errors While Entering Data, 12
- COMM Key, see Keys, COMM
- comm error**, see Communications Error
- comm gpib addr**, see IEEE-488 Address
- comm rs232 baud**, see RS-232 Baud Rate
- comm rs232 par**, see RS-232 Parity
- comm rs232 stop**, see RS-232 Stop Bits
- Command Delay Time, 40
- Commands Not Implemented, 40
- Commands**
 - Buffering, 25
 - Comments, 25
 - Processing, 25
 - Remote, 25
 - ***idn?**, see Identification
 - ***rst**, see Reset
 - ***tst ?**, see Self Test
 - ch aver bat**, see Average Batch Size
 - ch mem recall**, see Channel Recall
 - ch mem store**, see Channel Store
 - ch oper stat**, see Operating Mode
 - ch query**, see Display Current Reading
 - ch range max**, see Range, Maximum/Minimum
 - ch range min**, see Range, Maximum/Minimum
 - ch range**, see Range, Current
 - ch resp pyro**, see Responsivity
 - ch stat bat**, see Statistics Batch Size

- `ch stat mode`, see Statistics Restart Mode
- `ch stat send`, see Statistics Send
- `ch stat start`, see Statistics Batch Restart Mode
- `ch stat start`, see Statistics Start
- `ch trig lev`, see Trigger Level
- `ch trig src`, see Trigger Source
- `ch type`, see Probe Type
- `ch units`, see Units
- `ch zero`, see Zero
- `comm error`, see Communications Error
- `comm gpib addr`, see IEEE-488 Address
- `comm rs232 baud`, see RS-232 Baud Rate
- `comm rs232 par`, see RS-232 Parity
- `comm rs232 stop`, see RS-232 Stop Bits
- `loc`, 25
- `out buf`, see Output Buffer
- `out cont off`, 40
- `out cont`, see Output Continuous
- `out dep`, see Output Depth
- `out dump`, see Output Dump
- `out form`, see Output Format
- `syst opt aud`, see Audible Beeper
- `syst opt back`, see Backlight
- `syst opt line`, see Line Frequency
- `syst opt speed`, see Speedup
- Communication**
 - Error, 25, 27
 - Parameters, Modifying, 13
 - Settings**
 - EPM1000, 23
 - Host, 25
- Compatible Probes, 4
- Conducted Emissions Requirements, see Warranted Characteristics, Emissions
- Connecting a Powered Probe, 2
- Connection methods, 25
- CR, Adding to Command String, 39
- Current, Boosting External Trigger Source, 6
- Damage to the Instrument, 1, 2
- Data Buffer, 17
- Data Communications Equipment (DCE), 9
- Data**
 - Format, see Output Format
 - Headers, see Headers, Data
 - High Byte, 29, 31 (Figure)
 - Low Byte, 29, 31 (Figure)
 - Value, 31
- Data Terminal Equipment (DTE), 9
- DCE (Data Communications Equipment), 9
- Defaults, Factory, 19, 45
 - Reprogramming the EPM1000 with, 19
- Delay Time for Commands, 40
- DEV Annunciator, see Annunciator, DEV
- Digital Board, 44
- Digital Display, 10, (Figure), 11
- Digital Firmware Revision, 44
- Disconnecting a Powered Probe, 2
- Display Backlight, See Backlight
- Display Current Reading, 27
- Display, Clearing, 40
- Document Number, Inside Front Cover
- DTE (Data Terminal Equipment), 9
- Electrostatic Discharge, see Warranted Characteristics, Susceptibility
- Emissions, see Warranted Characteristics, Emissions
- EN 50081-1, see Warranted Characteristics, Emissions
- EN 50081-1, see Warranted Characteristics, Emissions
- EN 50082-1, see Warranted Characteristics, Susceptibility
- EN 55011, see Warranted Characteristics, Emissions
- ENT Key, see Keys, ENT
- Error Conditions, 18
- Estimating Final Power Value, 7
- European Requirements, see Warranted Characteristics, Emissions
- External Trigger**
 - Buffer Circuit (Figure), 6
 - Circuit, 6
 - Interface Circuit (Figure), 6
- Factory Defaults, see Defaults, Factory
- False Trigger (Figure), 5
- FAQ, see Troubleshooting
- Final Power Value, Estimating, 7
- Firmware Revisions, 44
 - Date, see Identification
- Format, Data**
 - Binary, 29
 - ASCII, 29, 31
 - ASCII+, 29, 32
- Front Panel (Figure), 10
- Function Keys, see Keys, Function
- Fuse**
 - Blowing, 41
 - Checking, 39
 - Holder, 8, 9, 41 (Figure)
 - Removal, 41 (Figure)
 - Replacement, 41 (Figure)
 - Type, 2, 9
- GPIOB, see IEEE-488
- Handshaking, Hardware, 9
- Hardware Handshaking, see Handshaking, Hardware
- Hazardous Conditions, 2
- Head Code, 32
- Headers, Data, 32
- HPIB, see IEEE-488
- Humidity, Operating, see Warranted Characteristics, Atmospherics
- IBM-AT Compatible PC, 9
- Identification, 27
 - IEC 801-3, see Warranted Characteristics, Susceptibility
 - IEC 801-4, see Warranted Characteristics, Susceptibility
 - IEC 802-2, see Warranted Characteristics, Susceptibility
- IEEE-488**
 - Address, 23, 27
 - Changing, 23
 - Cable, 9
 - Connector, 8, 9
 - Disabling, 23
 - Enabling, 23
 - Interface, 3, 25
 - Transfer Rates, 3

- Ignoring Probes, 39
- Indicator, Battery, 11
- Indicators, Scale 11
- Input Impedance, see Specifications, Input Impedance
- Input Signal, Rising or Falling Edge, 9
- Inspecting the Instrument, 1
- Interface, 3
- Internal Trigger, 4
- J9-0660 Pyroelectric Probe, 16
- Joules Key, see Keys, Joules
- Joules, Setting the EPM1000 for, 12
- Keys**
 - Arrow, 10, 12
 - Auto, 12
 - Average, 12
 - COMM, 13
 - ENT, 13
 - Function 10, 12
 - Joules, 12
 - Numeric Entry, 10, 13
 - SET, 13
 - Statistics, 12
 - System, 10, 13
 - Trigger, 12
 - Volts, 12
 - Watts, 12
 - Zero, 12
- LabVIEW®, 38
- Laser Outputs, Stable/Unstable, 7
- Line Frequency, 20, 28
 - Rejection, 20
- Linearity, see Specifications
- loc**, 25
- Local Control, Returning the EPM1000 to, 25
- Manual Information, 3
- Manual Restart Mode, see Statistics Batch Restart Mode, Manual
- MAX Annunciator, see Annunciator, MAX
- Maximum Rep Rate, see Specifications, Rep Rate, Maximum
- Mean Value Lower Than Expected, 40
- Measurement Units, Changing, Affecting Average Mode, 18
- Microsoft® Word, 3
- MIN Annunciator, see Annunciator, MIN
- Model Number, see Identification
- Modes**
 - Auto, 17
 - Average, 17
 - Normal, 17
 - Setting the EPM1000 for, 15, 16, 17
 - Statistics, 18
 - Setting the EPM1000 for, 12, 18
- Negative Readings During Thermopile Measurements, 11
- NEV, see Specifications, Noise Equivalent Voltage
- NIST-Traceable Performance, 41
- Noise Equivalent Voltage, see Specifications, Noise Equivalent Voltage
- Noisy Output, 39
- Normal Mode, see Modes, Normal
- Numeric Display, 10, 11
- Numeric Entry Keys, see Keys, Numeric Entry
- OL, see Overrange
- Operating in a Noisy Environment, 4
- Operating Mode, 28
- Optical Attenuation, 20
- Optocoupler Diode, 6
- out buf**, see Output Buffer
- out cont**, see Output Continuous
- out dep**, see Output Depth
- out dump**, see Output Dump
- out form**, see Output Format
- Output Buffer, 28
 - Circular Mode, 28
 - Dumping, 40
 - Fixed Mode, 28
 - Saving, 40
- Output Continuous, 28, 40
- Output Depth, 29
- Output Dump, 29
- Output Format, 29
- Overload Reading, 15, 16, 18
- Overview, 1
- Parity, see RS-232 Port Parity
- PM5K, 7
- Pomona Terminator, 8
- Power Cord, 2, 39
- Power Switch, 8, 9
- Power/Energy Density Limits, 15, 16
- Powered Probe, Connecting or Disconnecting, 2, 15
- Powered Probe, Joulemeter, 8
- PowerMax Probe, 32
- PowerMax®**
 - Function, 39
 - Thermopile Probes, 1, 8, 39
- Probe Data, Incoming, 17
- Probe Type, 32
- Probe, Properly Aligning, 39
- Probes, Compatible, 4
- Probes, PM5K, 7
- Probes**
 - Pyroelectric, 4
 - Thermopile, 4
- Programming, 25
 - Example, 38 (Figure)
- Pulse In Connector, 8, 16
- Pulse, with Noisy Tail, 22
- Pyroelectric Probes, see Probes, Pyroelectric
- Pyroelectric Responsivity, see Responsivity, Pyroelectric
- Pyroelectric Tutorial, see Tutorial, Pyroelectric
- Radiated Emissions, see Warranted Characteristics, Emissions
- Range**
 - Adjusting, 16
 - Current, 32
 - Determining Proper, 40
 - Maximum/Minimum, 33
- Rear Panel (Figure), 8
- Refresh Rate, Display, 17
- Rejection Frequencies, 20
- Reliable Trigger, 4, 5

- REM Annunciator, see Annunciator, REM
- Remote Commands, see Commands, Remote
- Rep Rate, see Specifications, Rep Rate, Maximum
- Reset, 25, 33
- Responsivity, 33
 - as V/mJ, 16
 - Automatically Programmed by Thermopile, 15
 - Pyroelectric, 20
 - Changing, 20
 - Thermopile, 20
 - Changing, 20
- Return Material Authorization, 41
- RMA, see Return Material Authorization
- RS-232 Port, 23
 - Baud Rate, 23, 33
 - Changing, 23
 - Connector, 3, 9
 - Disable, 23
 - Enable, 23
 - Interface, 8, 9, 25
 - Parity, 24, 34
 - Changing, 24
 - Stop Bits, 24, 34
 - Changing, 24
- Safety Information, 2
- Scale Indicators, see Indicators, Scale
- Scale, Analog Meter, see Analog Meter Scale
- Selective Speedup Mode, 7
- Self Test, 34
- Serial Connector, see RS-232 Port, Connector
- Serial Interface, see RS-232 Port, Interface
- Serial Number, 41
- Service, 2, 41
- SET Key, see Keys, SET
- Shipping an EPM1000, 41
- Shipping Carton, 41
- Sign Indicator, 11
- Slow Responding Probe, 15
- Smart Probe Connector, 8, 15, 16
- Specifications**
 - A/D Digital Resolution, 43
 - Analog Output
 - Full Scale, 43
 - Minimum Load, 43
 - Output Impedance, 8, 43
 - Baud Rate, 44
 - Dimensions, 44
 - Display, 43
 - Electrical/Mechanical, 43
 - Electronic Accuracy, 44
 - External Trigger Input, 43
 - Input Impedance, 43
 - Linearity, 43
 - Maximum Pyroelectric Pulse Width, 44
 - Noise Equivalent Voltage, 43
 - Power Requirements, 44
- Ranges
 - Energy, 43
 - Frequency, 43
 - Power, 43
 - Volts, 43
- RepRate, Maximum, 43
- Resolution
 - Energy, 43
 - Frequency, 43
 - Power, 43
 - Volts, 43
- System Accuracy, 44
- Weight, 44
- Speedup Feature (Figure), 7
- Speedup, Display, 19, 34
- Stable Laser Output, 7
- Statistics Batch Restart Mode, 21
 - Automatic, 21
 - Manual, 21
- Statistics Batch Size, 21, 35
 - Changing, 21
- Statistics Key, see Keys, Statistics
- Statistics Mode, see Mode, Statistics
- Statistics Restart, 35
- Statistics Send, 35
- Statistics Start, 36
- Status Byte, 29, (Figure) 30
- Stop Bits, see RS-232 Port Stop Bits
- sys opt aud**, see Audible Beeper
- sys opt back**, see Backlight
- sys opt line**, see Line Frequency
- sys opt speed**, see Speedup
- System Keys, see Keys, System
- Temperature, Operating, see Warranted Characteristics, Atmospheric
- Thermopile**
 - Output Noisy, 39
 - Probes, 1, 4
 - Responsivity, see Responsivity, Thermopile
 - Temperature, 18
 - Tutorial, see Tutorial, Thermopile
 - Zeroing, 15
- Time Delay, Command, 25
- TRG Annunciator, see Annunciator, TRG
- Trigger**
 - Holdoff, 5, 22
 - Changing, 22
 - Set Too Low, 40
 - In Connector, 4, 8, 9
 - Key, see Keys, Trigger
 - Level, 22, 36
 - Changing, 12, 22
 - Raising, 40
 - Source, 22, 36
 - Changing, 12, 22
 - None, 40
 - Reliable, 4, 5
 - Valid, 4, 5
- Terminator, see 50Ω Feedthrough Terminator

Troubleshooting, 39

Tutorial

- Pyroelectric, 16
- Thermopile, 15

Units and Ranges

- Energy, 3
- Frequency, 3
- Power, 3
- Volts, 3

Units, 36

Unpacking the Instrument, 1

Unrecognized SCPI command, 25

Unstable Laser Output, 7

User-Serviceable Parts, 41

Valid Trigger, see Trigger, Valid

Valid/Invalid Pulses (Figure), 4

Variations, Pulse-to-Pulse, Reducing, 17

Ventilation, 2

Vibration, see Warranted Characteristics, Dynamics

Virtual Instrument, 38

Volts Key, see Keys, Volts

Volts, Setting the EPM1000 for, 12

Warning Condition, Definition, 2

Warranted Characteristics

- Atmospherics, 45
- Dynamics, 45
- Emissions, 46
- Power, 45
- Susceptibility, 46

Watts Key, see Keys, Watts

Watts, Setting the EPM1000 for, 12

Wavelength Compensation, 21

- Activating, 21
- Changing, 21
- Deactivating, 21

Zero Adjustment Screw, 10, 13

Zero Baseline Value, see Zero

Zero Key, see Keys, Zero

Zero, 37

Zeroing the Display, 15



Artisan Technology Group is your source for quality new and certified-used/pre-owned equipment

- FAST SHIPPING AND DELIVERY
- TENS OF THOUSANDS OF IN-STOCK ITEMS
- EQUIPMENT DEMOS
- HUNDREDS OF MANUFACTURERS SUPPORTED
- LEASING/MONTHLY RENTALS
- ITAR CERTIFIED SECURE ASSET SOLUTIONS

SERVICE CENTER REPAIRS

Experienced engineers and technicians on staff at our full-service, in-house repair center

*InstraView*SM REMOTE INSPECTION

Remotely inspect equipment before purchasing with our interactive website at www.instraview.com ↗

WE BUY USED EQUIPMENT

Sell your excess, underutilized, and idle used equipment. We also offer credit for buy-backs and trade-ins. www.artisanng.com/WeBuyEquipment ↗

LOOKING FOR MORE INFORMATION?

Visit us on the web at www.artisanng.com ↗ for more information on price quotations, drivers, technical specifications, manuals, and documentation

Contact us: (888) 88-SOURCE | sales@artisanng.com | www.artisanng.com