

OPERATING INSTRUCTIONS AND SPECIFICATIONS

NI 9203

8-Channel, ± 20 mA, 16-Bit Analog Input Module

Français Deutsch 日本語 한국어 简体中文

ni.com/manuals

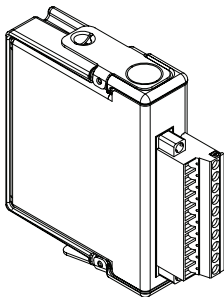

This document describes how to use the National Instruments 9203 and includes specifications and terminal assignments for the NI 9203. Visit `ni.com/info` and enter `rdsoftwareversion` to determine which software you need for the modules you are using. For information about installing, configuring, and programming the system, refer to the system documentation. Visit `ni.com/info` and enter `cseriesdoc` for information about C Series documentation.



Note The safety guidelines and specifications in this document are specific to the NI 9203. The other components in the system might not meet the same safety ratings and specifications. Refer to the documentation for each component in the system to determine the safety ratings and specifications for the entire system. Visit `ni.com/info` and enter `cseriesdoc` for information about C Series documentation.

Safety Guidelines

Operate the NI 9203 only as described in these operating instructions.



Hot Surface This icon denotes that the component may be hot. Touching this component may result in bodily injury.

Safety Guidelines for Hazardous Locations

The NI 9203 is suitable for use in Class I, Division 2, Groups A, B, C, D, T4 hazardous locations; Class I, Zone 2, AEx nC IIC T4, and Ex nC IIC T4 hazardous locations; and nonhazardous locations only. Follow these guidelines if you are installing the NI 9203 in a potentially explosive environment. Not following these guidelines may result in serious injury or death.



Caution Do *not* disconnect I/O-side wires or connectors unless power has been switched off or the area is known to be nonhazardous.



Caution Do *not* remove modules unless power has been switched off or the area is known to be nonhazardous.



Caution Substitution of components may impair suitability for Class I, Division 2.



Caution For Zone 2 applications, install the system in an enclosure rated to at least IP 54 as defined by IEC 60529 and EN 60529.

Special Conditions for Hazardous Locations Use in Europe

This equipment has been evaluated as EEx nC IIC T4 equipment under DEMKO Certificate No. 03 ATEX 0324020X. Each module is marked  II 3G and is suitable for use in Zone 2 hazardous locations. If you are using the NI 9203 in Gas Group IIC hazardous locations or in ambient temperatures of $-40\text{ }^{\circ}\text{C} \leq T_a \leq 70\text{ }^{\circ}\text{C}$, you must use the device in an NI chassis that has been evaluated as EEx nC IIC T4, Ex nA IIC T4, or Ex nL IIC T4 equipment.

Special Conditions for Marine Applications

Some modules are Lloyd's Register (LR) Type Approved for marine applications. To verify Lloyd's Register certification, visit ni.com/certification and search for the LR certificate, or look for the Lloyd's Register mark on the module.



Caution To meet radio frequency emission requirements for marine applications, use shielded cables and install the system in a metal enclosure. Suppression ferrites must be installed on power supply inputs near power entries to modules and controllers. Power supply and module cables must be separated on opposite sides of the enclosure and must enter and exit through opposing enclosure walls.

Connecting the NI 9203

The NI 9203 has a 10-terminal, detachable, screw-terminal connector that provides connections for 8 analog input channels.

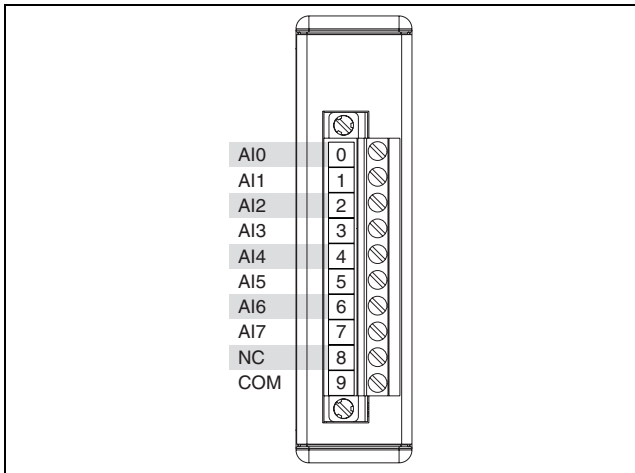

Figure 1. NI 9203 Terminal Assignments

Each channel has an AI terminal to which you can connect a current signal. The NI 9203 also has a common terminal, COM, that is internally connected to the isolated ground reference of the module.

The input signals are buffered, conditioned, and sampled by a single 16-bit ADC. The module protects each channel from overvoltages. Refer to the [Specifications](#) section for information about overvoltage protection. Refer to Figure 2 for an illustration of the input circuitry on the NI 9203.

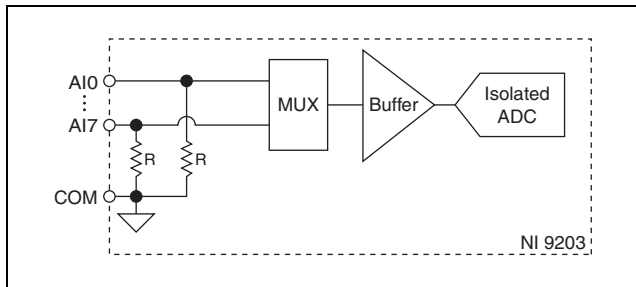

Figure 2. Input Circuitry on the NI 9203

You can connect single-ended current signals to the NI 9203. Connect the positive lead of the current signal to the AI terminal. Connect the negative lead to the COM terminal. Refer to Figure 3 for an illustration of how to connect single-ended current signals to the NI 9203.

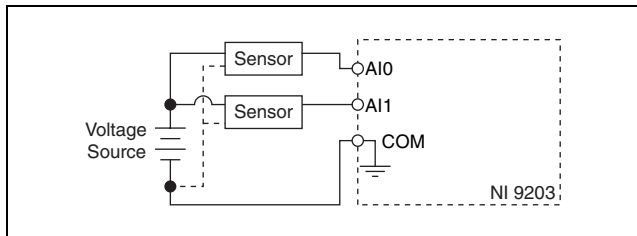

Figure 3. Connecting Single-Ended Current Signals to the NI 9203



Note You must use 2-wire ferrules to create a secure connection when connecting more than one wire to a single terminal on the NI 9203.

Wiring for High-Vibration Applications

If an application is subject to high vibration, National Instruments recommends that you either use ferrules to terminate wires to the detachable screw-terminal connector or use the NI 9932 backshell kit to protect the connections. Refer to Figure 4 for an illustration of using ferrules. Refer to Figure 5 for an illustration of the NI 9932 connector backshell.

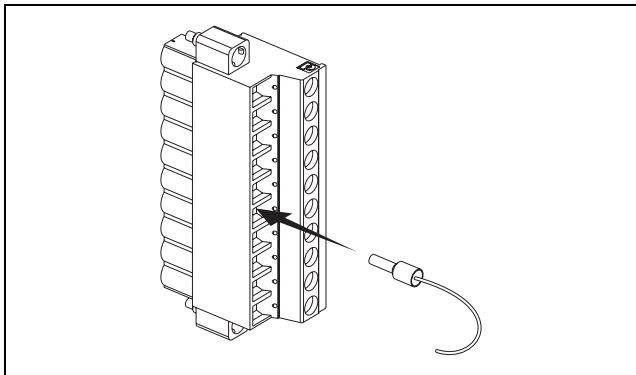

Figure 4. 10-Terminal Detachable Screw-Terminal Connector with Ferrule

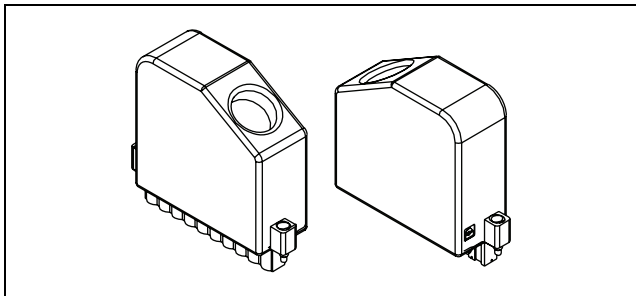

Figure 5. NI 9932 Connector Backshell

Sleep Mode

This module supports a low-power sleep mode. Support for sleep mode at the system level depends on the chassis that the module is plugged into. Refer to the chassis manual for information about support for sleep mode. If the chassis supports sleep mode, refer to the software help for information about enabling sleep mode. Visit ni.com/info and enter `cseriesdoc` for information about C Series documentation.

Typically, when a system is in sleep mode, you cannot communicate with the modules. In sleep mode, the system consumes minimal power and may dissipate less heat than it does in normal mode. Refer to the *Specifications* section for more information about power consumption and thermal dissipation.

Specifications

The following specifications are typical for the range -40 to 70 °C unless otherwise noted. All voltages are relative to COM unless otherwise noted.

Input Characteristics

Number of channels	8 analog input channels
ADC resolution	16 bits
Type of ADC	Successive approximation register (SAR)
Nominal input	
Unipolar	0 to 20 mA
Bipolar	± 20 mA

Minimum overrange

Unipolar..... 6.5%

Bipolar..... 5.5%

Overvoltage protection ± 30 V Ch-to-COM max

Sample rate

R Series Expansion chassis 192 kS/s max

All other chassis 200 kS/s max

Conversion time

R Series Expansion chassis 5.2 μ s min

All other chassis 5 μ s min

Unipolar accuracy

Measurement Conditions	Percent of Reading (Gain Error)	Percent of Range* (Offset Error)
Calibrated max (-40 to 70 °C)	±0.18%	±0.06%
Calibrated typ (25 °C, ±5 °C)	±0.04%	±0.02%
Uncalibrated max (-40 to 70 °C)	±0.66%	±0.54%
Uncalibrated typ (25 °C, ±5 °C)	±0.49%	±0.46%
* Range equals 21.5 mA.		

Bipolar accuracy

Measurement Conditions	Percent of Reading (Gain Error)	Percent of Range* (Offset Error)
Calibrated max (-40 to 70 °C)	±0.20%	±0.09%
Calibrated typ (25 °C, ±5 °C)	±0.05%	±0.02%
Uncalibrated max (-40 to 70 °C)	±0.74%	±0.66%
Uncalibrated typ (25 °C, ±5 °C)	±0.54%	±0.55%
* Range equals 43 mA (±21.5 mA).		

Scaling coefficients

Unipolar..... 330 nA/LSB typ

Bipolar..... 660 nA/LSB typ

Unipolar stability

Offset drift 63 nA/°C

Gain drift ±14 ppm/°C

Bipolar stability

Offset drift 286 nA/°C

Gain drift ±17 ppm/°C

Input bandwidth (–3 dB)..... 850 kHz

Input impedance

Resistance 138 Ω

Capacitance 20 pF

Input noise (code-centered)

RMS 1 LSB_{rms}

Peak-to-peak..... 7 LSB

No missing codes..... 16 bits

INL..... ±3 LSB max

Crosstalk (at 1 kHz)..... –100 dB

Settling time (to 2 LSB)..... 5 μs

MTBF 1,522,814 hours at 25 °C;
Bellcore Issue 6, Method 1,
Case 3, Limited Part Stress
Method



Note Contact NI for Bellcore MTBF specifications at other temperatures or for MIL-HDBK-217F specifications.

Power Requirements

Power consumption from chassis

Active mode 399 mW max

Sleep mode 5 mW max

Thermal dissipation (at 70 °C)

Active mode 1.22 W max

Sleep mode 824 mW max

Physical Characteristics

If you need to clean the module, wipe it with a dry towel.

Screw-terminal wiring	12 to 24 AWG copper conductor wire with 10 mm (0.39 in.) of insulation stripped from the end
Ferrules	0.25 mm ² to 2.5 mm ²
Torque for screw terminals	0.5 to 0.6 N · m (4.4 to 5.3 lb · in.)
Weight.....	162 g (5.7 oz)

Safety

Safety Voltages

Connect only voltages that are within the following limits.

Channel-to-COM

±30 VDC max

Isolation

Channel-to-channel	No isolation between channels
--------------------------	-------------------------------

Channel-to-earth ground

Continuous 250 V_{rms}, Measurement
Category II

Withstand 2,300 V_{rms}, verified by a 5 s
withstand test

Measurement Category II is for measurements performed on circuits directly connected to the electrical distribution system. This category refers to local-level electrical distribution, such as that provided by a standard wall outlet, for example, 115 V for U.S. or 230 V for Europe.



Caution Do *not* connect the NI 9203 to signals or use for measurements within Measurement Categories III or IV.

Safety Standards

This product is designed to meet the requirements of the following standards of safety for electrical equipment for measurement, control, and laboratory use:

- IEC 61010-1, EN 61010-1
- UL 61010-1, CSA 61010-1



Note For UL and other safety certifications, refer to the product label or visit ni.com/certification, search by module number or product line, and click the appropriate link in the Certification column.

Hazardous Locations

U.S. (UL)	Class I, Division 2, Groups A, B, C, D, T4; Class I, Zone 2, AEx nC IIC T4
Canada (C-UL)	Class I, Division 2, Groups A, B, C, D, T4; Class I, Zone 2, Ex nC IIC T4
Europe (DEMKO).....	EEx nC IIC T4

Environmental

National Instruments C Series modules are intended for indoor use only but may be used outdoors if installed in a suitable enclosure. Refer to the manual for the chassis you are using for more information about meeting these specifications.

Operating temperature (IEC 60068-2-1, IEC 60068-2-2)	-40 to 70 °C
Storage temperature (IEC 60068-2-1, IEC 60068-2-2)	-40 to 85 °C
Ingress protection.....	IP 40
Operating humidity (IEC 60068-2-56).....	10 to 90% RH, noncondensing
Storage humidity (IEC 60068-2-56).....	5 to 95% RH, noncondensing
Maximum altitude.....	2,000 m
Pollution Degree (IEC 60664)	2

Shock and Vibration

To meet these specifications, you must panel mount the system and either affix ferrules to the ends of the terminal wires or use the NI 9932 backshell kit to protect the connections.

Operating vibration

Random (IEC 60068-2-64)..... 5 g_{rms}, 10 to 500 Hz

Sinusoidal (IEC 60068-2-6)

5 g, 10 to 500 Hz

Operating shock
(IEC 60068-2-27)..... 30 g, 11 ms half sine,
50 g, 3 ms half sine,
18 shocks at 6 orientations

Electromagnetic Compatibility

This product is designed to meet the requirements of the following standards of EMC for electrical equipment for measurement, control, and laboratory use:

- EN 61326 EMC requirements; Industrial Immunity
- EN 55011 Emissions; Group 1, Class A
- CE, C-Tick, ICES, and FCC Part 15 Emissions; Class A



Note For EMC compliance, operate this device with shielded cabling.

CE Compliance

This product meets the essential requirements of applicable European directives, as amended for CE markings, as follows:

- 2006/95/EC; Low-Voltage Directive (safety)
- 2004/108/EC; Electromagnetic Compatibility Directive (EMC)



Note Refer to the Declaration of Conformity (DoC) for this product for any additional regulatory compliance information. To obtain the DoC for this product, visit ni.com/certification, search by module number or product line, and click the appropriate link in the Certification column.

Environmental Management

National Instruments is committed to designing and manufacturing products in an environmentally responsible manner. NI recognizes that eliminating certain hazardous substances from our products is beneficial not only to the environment but also to NI customers.

For additional environmental information, refer to the *NI and the Environment* Web page at ni.com/environment. This page contains the environmental regulations and directives with which NI complies, as well as other environmental information not included in this document.

Waste Electrical and Electronic Equipment (WEEE)



EU Customers At the end of their life cycle, all products *must* be sent to a WEEE recycling center. For more information about WEEE recycling centers and National Instruments WEEE initiatives, visit ni.com/environment/weee.htm.

电子信息产品污染控制管理办法（中国 RoHS）



中国客户 National Instruments 符合中国电子信息产品中限制使用某些有害物质指令 (RoHS)。关于 National Instruments 中国 RoHS 合规性信息，请登录 ni.com/environment/rohs_china。(For information about China RoHS compliance, go to ni.com/environment/rohs_china.)

Calibration

You can obtain the calibration certificate and information about calibration services for the NI 9203 at ni.com/calibration.

Calibration interval 1 year

Where to Go for Support

The National Instruments Web site is your complete resource for technical support. At ni.com/support you have access to everything from troubleshooting and application development self-help resources to email and phone assistance from NI Application Engineers.

National Instruments corporate headquarters is located at 11500 North Mopac Expressway, Austin, Texas, 78759-3504. National Instruments also has offices located around the world to help address your support needs. For telephone support in the United States, create your service request at ni.com/support and follow the calling instructions or dial 512 795 8248. For telephone support outside the United States, contact your local branch office:

Australia 1800 300 800, Austria 43 662 457990-0,
Belgium 32 (0) 2 757 0020, Brazil 55 11 3262 3599,

Canada 800 433 3488, China 86 21 5050 9800,
Czech Republic 420 224 235 774, Denmark 45 45 76 26 00,
Finland 358 (0) 9 725 72511, France 01 57 66 24 24,
Germany 49 89 7413130, India 91 80 41190000,
Israel 972 3 6393737, Italy 39 02 41309277, Japan 0120-527196,
Korea 82 02 3451 3400, Lebanon 961 (0) 1 33 28 28,
Malaysia 1800 887710, Mexico 01 800 010 0793,
Netherlands 31 (0) 348 433 466, New Zealand 0800 553 322,
Norway 47 (0) 66 90 76 60, Poland 48 22 3390150,
Portugal 351 210 311 210, Russia 7 495 783 6851,
Singapore 1800 226 5886, Slovenia 386 3 425 42 00,
South Africa 27 0 11 805 8197, Spain 34 91 640 0085,
Sweden 46 (0) 8 587 895 00, Switzerland 41 56 2005151,
Taiwan 886 02 2377 2222, Thailand 662 278 6777,
Turkey 90 212 279 3031, United Kingdom 44 (0) 1635 523545

National Instruments, NI, ni.com, and LabVIEW are trademarks of National Instruments Corporation. Refer to the *Terms of Use* section on ni.com/legal for more information about National Instruments trademarks. Other product and company names mentioned herein are trademarks or trade names of their respective companies. For patents covering National Instruments products, refer to the appropriate location: **Help»Patents** in your software, the `patents.txt` file on your CD, or ni.com/patents.

© 2005–2008 National Instruments Corp. All rights reserved.