

OPERATING INSTRUCTIONS AND SPECIFICATIONS

NI 9205

32-Channel, ± 200 mV to ± 10 V, 16-Bit Analog Input Module

Français Deutsch 日本語 한국어 简体中文

ni.com/manuals

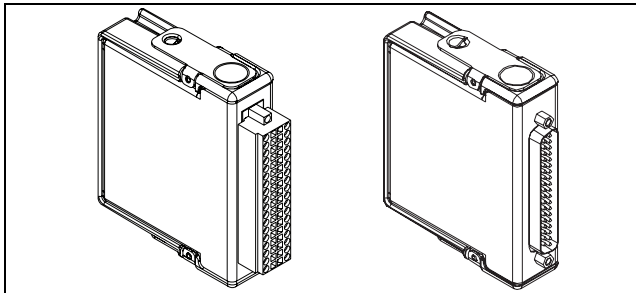

This document describes how to use the National Instruments 9205 and includes specifications and pin assignments for the NI 9205. In this document, the NI 9205 with spring terminal and the NI 9205 with DSUB are referred to inclusively as the NI 9205. Visit ni.com/info and enter `rdsoftwareversion` to determine which software you need for the modules you are using. For information about installing, configuring, and programming the system, refer to the system documentation. Visit ni.com/info and enter `cseriesdoc` for information about C Series documentation.



Note The safety guidelines and specifications in this document are specific to the NI 9205. The other components in the system might not meet the same safety ratings and specifications. Refer to the documentation for each component in the system to determine the safety ratings and specifications for the entire system. Visit ni.com/info and enter `cseriesdoc` for information about C Series documentation.

Safety Guidelines

Operate the NI 9205 only as described in these operating instructions.



Hot Surface This icon denotes that the component may be hot. Touching this component may result in bodily injury.

Safety Guidelines for Hazardous Voltages

You can connect hazardous voltages only to the NI 9205 with spring terminal. Do *not* connect hazardous voltages to the NI 9205 with DSUB.

If hazardous voltages are connected to the module, take the following precautions. A hazardous voltage is a voltage greater than $42.4 V_{pk}$ or 60 VDC to earth ground.



Caution Ensure that hazardous voltage wiring is performed only by qualified personnel adhering to local electrical standards.



Caution Do *not* mix hazardous voltage circuits and human-accessible circuits on the same module.



Caution Make sure that devices and circuits connected to the module are properly insulated from human contact.



Caution When module terminals are hazardous voltage LIVE ($>42.4V_{pk}/60$ VDC), you must ensure that devices and circuits connected to the module are properly insulated from human contact. You must use the NI 9940 connector backshell to ensure that the terminals are *not* accessible. Figure 1 shows the NI 9940 connector backshell.



Note You can use the NI 9940 connector backshell only with the NI 9205 with spring terminal.

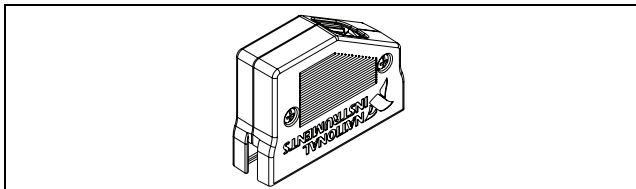

Figure 1. NI 9940 Connector Backshell

Safety Guidelines for Hazardous Locations

The NI 9205 is suitable for use in Class I, Division 2, Groups A, B, C, D, T4 hazardous locations; Class I, Zone 2, AEx nC IIC T4 and

Ex nC IIC T4 hazardous locations; and nonhazardous locations only. Follow these guidelines if you are installing the NI 9205 in a potentially explosive environment. Not following these guidelines may result in serious injury or death.



Caution Do *not* disconnect I/O-side wires or connectors unless power has been switched off or the area is known to be nonhazardous.



Caution Do *not* remove modules unless power has been switched off or the area is known to be nonhazardous.



Caution Substitution of components may impair suitability for Class I, Division 2.



Caution For Zone 2 applications, install the system in an enclosure rated to at least IP 54 as defined by IEC 60529 and EN 60529.



Caution For Zone 2 applications, connected signals must be within the following limits:

Capacitance 0.2 μ F max

Special Conditions for Hazardous Locations Use in Europe

This equipment has been evaluated as EEx nC IIC T4 equipment under DEMKO Certificate No. 03 ATEX 0324020X. Each module is marked $\langle \text{Ex} \rangle$ II 3G and is suitable for use in Zone 2 hazardous locations. If you are using the NI 9205 in Gas Group IIC hazardous locations or in ambient temperatures of $-40\text{ }^{\circ}\text{C} \leq T_a \leq 70\text{ }^{\circ}\text{C}$, you must use the device in an NI chassis that has been evaluated as EEx nC IIC T4, Ex nA IIC T4, or Ex nL IIC T4 equipment.

Special Conditions for Marine Applications

Some modules are Lloyd's Register (LR) Type Approved for marine applications. To verify Lloyd's Register certification, visit ni.com/certification and search for the LR certificate, or look for the Lloyd's Register mark on the module.



Caution To meet radio frequency emission requirements for marine applications, use shielded cables and install the system in a metal enclosure. Suppression ferrites must be installed on power supply inputs near power entries to modules and controllers. Power supply and module cables must be separated on opposite sides of the enclosure and must enter and exit through opposing enclosure walls.

Connecting the NI 9205

The NI 9205 is a 32-channel single-ended/16-channel differential analog input module.

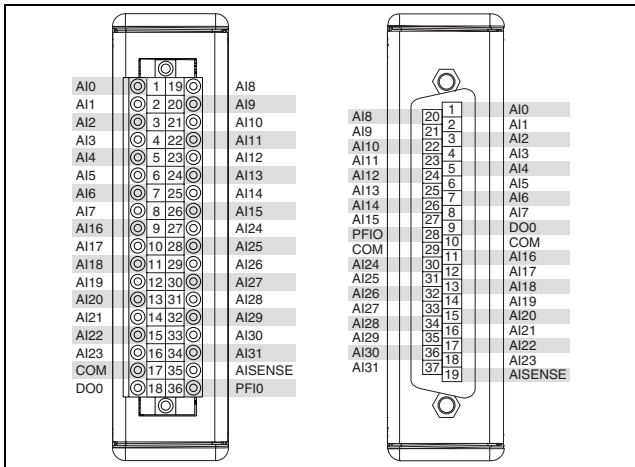

Figure 2. NI 9205 Terminal and Pin Assignments

The NI 9205 provides connections for the 32 single-ended or 16 differential analog input channels, as well as one digital input channel, one digital output channel, COM, and AI SENSE.



Note The digital output channel is supported only in CompactRIO systems.

The NI 9205 with spring terminal has a 36-terminal detachable spring-terminal connector, and the NI 9205 with DSUB has a 37-pin DSUB connector. Each analog input channel has an AI terminal or pin to which you can connect an analog output device. The NI 9205 is capable of an aggregate sampling rate of 250 kS/s. The NI 9205 also supports triggering. Refer to the software help for information about input trigger modes.

The NI 9205 channels share a common ground that is isolated from the other modules in the system. All channels share a programmable gain instrumentation amplifier and are multiplexed to an ADC. Each channel also has ± 30 V overvoltage protection. For more information about overvoltage protection, refer to the [Specifications](#) section. Refer to Figure 3 for an illustration of the input circuitry for one analog input channel on the NI 9205.

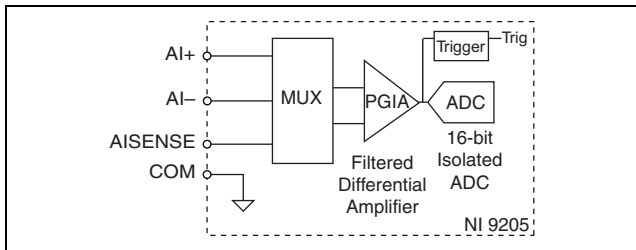

Figure 3. Input Circuitry for One Analog Channel on the NI 9205

Connecting Wires to the NI 9205 Spring-Terminal Connector

Use a flathead screwdriver with a blade smaller than 2.3×1.0 mm (0.09×0.04 in.) to connect wires to the detachable spring-terminal connector. Insert the screwdriver into a spring clamp activation slot and press a wire into the corresponding connector terminal, then remove the screwdriver to clamp the wire into the terminal.

Refer to the [Specifications](#) section for more information about spring-terminal wiring. Refer to Figure 4 for an illustration of connecting wires to the NI 9205 with spring terminal.

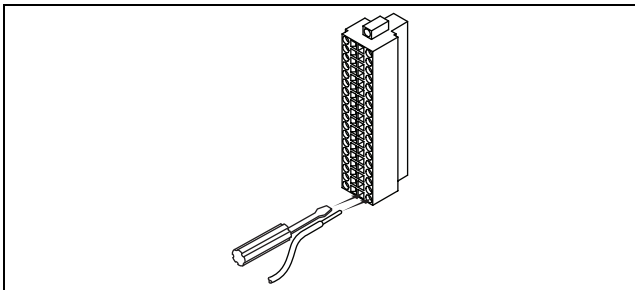

Figure 4. Connecting Wires to the NI 9205 with Spring-Terminal Connector

Wiring for High-Vibration Applications

If an application is subject to high vibration, National Instruments recommends that you use a backshell kit or shielded cable to protect the connections. For the NI 9205 with spring terminal, use the NI 9940 backshell to protect the connections. For the NI 9205 with DSUB, use a 37-pin shielded cable or the NI 9933 backshell to protect the connections. Refer to Figure 1 for an illustration of the NI 9940 connector backshell. Refer to Figure 5 for an illustration of the NI 9933 connector backshell.

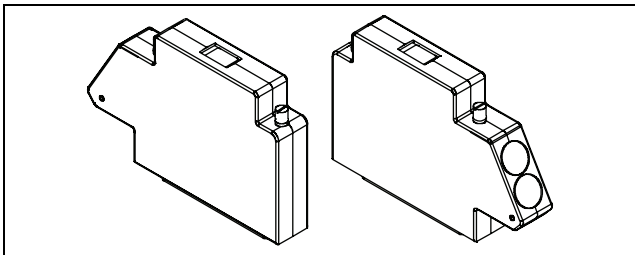

Figure 5. NI 9933 Connector Backshell

Connecting Devices to the NI 9205

You can connect the NI 9205 directly to a variety of devices and other signal sources. Make sure the devices you connect to the NI 9205 are compatible with the input specifications of the module. Refer to the [Specifications](#) section for more information about the input specifications.

When connecting various sources to the NI 9205, you can use differential, single-ended, or a combination of differential and single-ended connections. Refer to Figures 6, 7, and 8 for diagrams of each connection type.

Differential Measurements

You can use a differential measurement configuration to attain more accurate measurements and less noise. A differential measurement configuration requires two inputs for each measurement, thus reducing the number of available channels on the NI 9205 to 16. Table 1 shows the signal pairs that are valid for differential connection configurations with the NI 9205.

Table 1. Differential Pairs

Channel	Signal+	Signal-	Channel	Signal+	Signal-
0	AI0	AI8	16	AI16	AI24
1	AI1	AI9	17	AI17	AI25
2	AI2	AI10	18	AI18	AI26
3	AI3	AI11	19	AI19	AI27
4	AI4	AI12	20	AI20	AI28
5	AI5	AI13	21	AI21	AI29
6	AI6	AI14	22	AI22	AI30
7	AI7	AI15	23	AI23	AI31

Refer to Figure 6 for an illustration of connecting a device to the NI 9205 using differential connections.

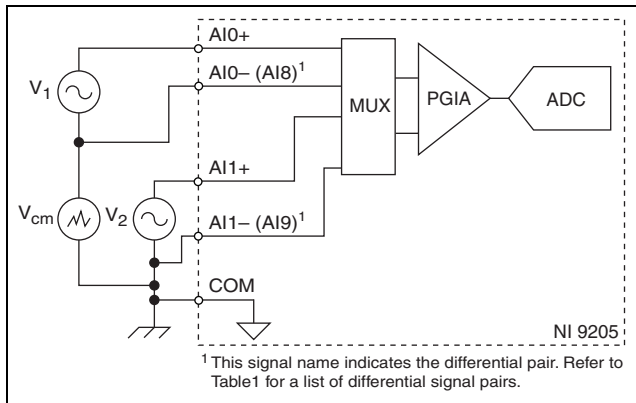

Figure 6. Connecting a Device to the NI 9205 Using Differential Connections

In a differential connection configuration, the NI 9205 rejects the common-mode noise voltage, V_{cm} , during the measurement of V_1 .

Referenced Single-Ended (RSE) Measurements

You can use an RSE measurement configuration to take measurements on 32 channels when all channels share a common ground. Refer to Figure 7 for an illustration of connecting a device to the NI 9205 using RSE connections.

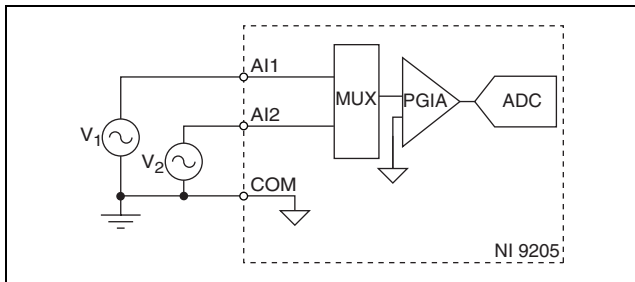

Figure 7. Connecting a Device to the NI 9205 Using RSE Connections

In an RSE connection configuration, the NI 9205 measures each input channel with respect to COM.



Note If you leave COM unconnected, the signals float outside the working input range of the NI 9205. This may result in unreliable measurements because there is no way to ensure that the input signal is within 10 V of COM.

Non-Referenced, Single-Ended (NRSE) Measurements

You can use an NRSE measurement configuration to take measurements on all 32 channels while reducing noise more effectively than with an RSE connection configuration. This configuration provides remote sense for the negative (–) input of the PGIA that is shared by all channels configured for NRSE mode. The behavior of this configuration is similar to the behavior of RSE connections, but it provides improved noise rejection. Refer to Figure 8 for an illustration of connecting a device to the NI 9205 using NRSE connections.

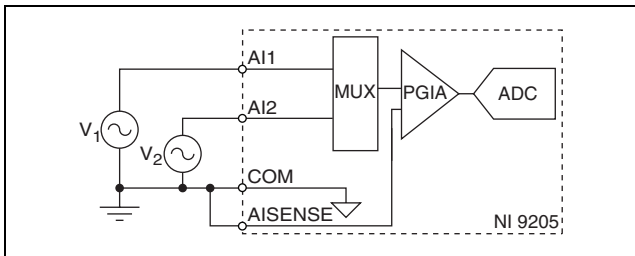

Figure 8. Connecting a Device to the NI 9205 Using NRSE Connections

In an NRSE connection configuration, the NI 9205 measures each input channel with respect to AI SENSE.

Sleep Mode

This module supports a low-power sleep mode. Support for sleep mode at the system level depends on the chassis that the module is plugged into. Refer to the chassis manual for information about support for sleep mode. If the chassis supports sleep mode, refer to the software help for information about enabling sleep mode. Visit ni.com/info and enter `cseriesdoc` for information about C Series documentation.

Typically, when a system is in sleep mode, you cannot communicate with the modules. In sleep mode, the system consumes minimal power and may dissipate less heat than it does in normal mode. Refer to the *Specifications* section for more information about power consumption and thermal dissipation.

Specifications

The following specifications are typical for the range -40 to 70 °C unless otherwise noted. All voltages are relative to COM unless otherwise noted.

Analog Input Characteristics

Number of channels.....	32 single-ended or 16 differential analog input channels, 1 digital input channel, and 1 digital output channel
ADC resolution.....	16 bits
DNL.....	No missing codes guaranteed

INL.....	Refer to the <i>AI Absolute Accuracy Tables and Formulas</i>
MTBF	775,832 hours at 25 °C; Bellcore Issue 6, Method 1, Case 3, Limited Part Stress Method



Note Contact NI for Bellcore MTBF specifications at other temperatures or for MIL-HDBK-217F specifications.

Conversion time

R Series Expansion chassis 4.50 μ s (222 kS/s)

All other chassis 4.00 μ s (250 kS/s)

Input coupling..... DC

Nominal input ranges..... ± 10 V, ± 5 V, ± 1 V, ± 0.2 V

Minimum overrange

(for 10 V range) 4%

Maximum working voltage for analog inputs

(signal + common mode)..... Each channel must remain within ± 10.4 V of common

Input impedance (AI-to-COM)

Powered on >10 G Ω in parallel
with 100 pF

Powered off/overload 4.7 k Ω min

Input bias current \pm 100 pA

Crosstalk (at 100 kHz)

Adjacent channels -65 dB

Non-adjacent channels -70 dB

Analog bandwidth..... 370 kHz

Overvoltage protection

AI channel (0 to 31) \pm 30 V (one channel only)

AISENSE \pm 30 V

CMRR (DC to 60 Hz)..... 100 dB

Typical AI+ to AI- CMRR graph

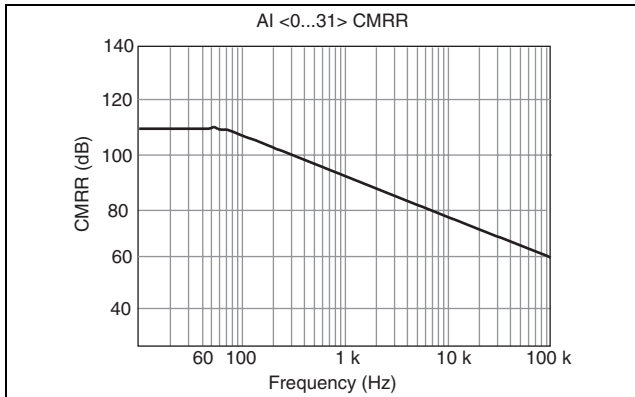

Settling time for multichannel measurements, accuracy, all ranges

± 120 ppm of full-scale step

(± 8 LSB)..... 4 μ s convert interval

± 30 ppm of full-scale step

(± 2 LSB)..... 8 μ s convert interval

Analog triggers

Number of triggers	1
Resolution.....	10 bits, 1 in 1,024
Bandwidth (–3 dB)	370 kHz
Accuracy.....	±1% of full scale

Scaling coefficients

Nominal Range (V)	Typical Scaling Coefficient (μV/LSB)
±10	328
±5	164.2
±1	32.8
±0.2	6.57

AI Absolute Accuracy Tables and Formulas

The values in the following tables are based on calibrated scaling coefficients, which are stored in the onboard EEPROM.

Accuracy summary

Nominal Range (V)	Absolute Accuracy at Full Scale* (μV)	Random Noise, σ (μVrms)	Sensitivity [†] (μV)
± 10	6,230	240	96.0
± 5	3,230	116	46.4
± 1	690	26	10.4
± 0.2	174	10	4.0

* Absolute accuracy values at full scale on the analog input channels assume the device is operating within 70 °C of the last external calibration and are valid for averaging 100 samples immediately following internal calibration. Refer to the [Absolute accuracy formulas](#) for more information.

† Sensitivity is the smallest voltage change that can be detected. It is a function of noise.

Accuracy details

Nominal Range (V)	Residual Gain Error (ppm of Reading)	Gain Tempco (ppm/°C)	Reference Tempco	Residual Offset Error (ppm of Range)	Offset Tempco (ppm of Range/°C)	INL Error (ppm of Range)
±10	115	11	5	20	44	76
±5	135	11	5	20	47	76
±1	155	11	5	25	66	76
±0.2	215	11	5	40	162	76

Absolute accuracy formulas

$AbsoluteAccuracy = Reading \cdot GainError + Range \cdot OffsetError + NoiseUncertainty$

$GainError = ResidualGainError + GainTempco \cdot TempChangeFromLastInternalCal + ReferenceTempco \cdot TempChangeFromLastExternalCal$

$OffsetError = ResidualOffsetError + OffsetTempco \cdot TempChangeFromLastInternalCal + INL_Error$

$NoiseUncertainty = (RandomNoise \cdot 3) / \sqrt{100}$ for a coverage factor of 3σ and averaging 100 points.

Absolute accuracy at full scale on the analog input channels is determined using the following assumptions:

$TempChangeFromLastExternalCal = 70 \text{ }^\circ\text{C}$

$TempChangeFromLastInternalCal = 1 \text{ }^\circ\text{C}$

$NumberOfReadings = 100$

$CoverageFactor = 3 \sigma$

For example, on the 10 V range, the absolute accuracy at full scale is as follows:

$GainError = 115 \text{ ppm} + 11 \text{ ppm} \cdot 1 + 5 \text{ ppm} \cdot 70$

$GainError = 476 \text{ ppm}$

$OffsetError = 20 \text{ ppm} + 44 \text{ ppm} \cdot 1 + 76 \text{ ppm}$

$OffsetError = 140 \text{ ppm}$

$NoiseUncertainty = (240 \text{ } \mu\text{V} \cdot 3) / \sqrt{100}$

$NoiseUncertainty = 72 \text{ } \mu\text{V}$

$AbsoluteAccuracy = 10 \text{ V} \cdot 476 \text{ ppm} + 10 \text{ V} \cdot 140 \text{ ppm} + 72 \text{ } \mu\text{V}$

$AbsoluteAccuracy = 6,232 \text{ } \mu\text{V}$ (rounds to 6,230 μV)

Digital Characteristics

Overvoltage protection ± 30 V

Digital input logic levels

Level	Min	Max
Input high voltage (V_{IH})	2.0 V	3.3 V
Input low voltage (V_{IL})	0 V	0.34 V

Digital output logic levels

Level	Min	Max
Output high voltage (V_{OH}), sourcing 75 μ A	2.1 V	3.3 V
Output low voltage (V_{OL}), sinking 250 μ A	0 V	0.4 V

External digital triggers

Source PFIO

Delay 100 ns max

Power Requirements

Power consumption from chassis

Active mode 625 mW max

Sleep mode 15 mW

Thermal dissipation (at 70 °C)

Active mode 625 mW max

Sleep mode 15 mW

Physical Characteristics

If you need to clean the module, wipe it with a dry towel.

Spring-terminal wiring..... 18 to 28 AWG copper
conductor wire with 7 mm
(0.28 in.) of insulation
stripped from the end

Weight

NI 9205 with spring terminal 158 g (5.8 oz)

NI 9205 with DSUB 148 g (5.3 oz)

Safety

Maximum Voltage¹

Connect only voltages that are within the following limits.

AI, PFI0, and DO-to-COM ± 30 VDC

NI 9205 with Spring Terminal Isolation Voltages

Channel-to-channel None

Channel-to-earth ground

Continuous $250 V_{\text{rms}}$, Measurement
Category II

Withstand $2,300 V_{\text{rms}}$, verified by a 5 s
dielectric withstand test

Measurement Category II is for measurements performed on circuits directly connected to the electrical distribution system. This category refers to local-level electrical distribution, such as that provided by a standard wall outlet, for example, 115 V for U.S. or 230 V for Europe.

¹ The maximum voltage that can be applied or output between AI and COM without creating a safety hazard.



Caution Do *not* connect the NI 9205 with spring terminal to signals or use for measurements within Measurement Categories III or IV.

NI 9205 with DSUB Isolation Voltages

Channel-to-channel.....None

Channel-to-earth ground

Continuous 60 VDC, Measurement
Category I

Withstand..... 1,000 V_{rms}, verified by a 5 s
dielectric withstand test

Measurement Category I is for measurements performed on circuits not directly connected to the electrical distribution system referred to as *MAINS* voltage. *MAINS* is a hazardous live electrical supply system that powers equipment. This category is for measurements of voltages from specially protected secondary circuits. Such voltage measurements include signal levels, special equipment, limited-energy parts of equipment, circuits powered by regulated low-voltage sources, and electronics.



Caution Do *not* connect the NI 9205 with DSUB to signals or use for measurements within Measurement Categories II, III, or IV.

Safety Standards

This product is designed to meet the requirements of the following standards of safety for electrical equipment for measurement, control, and laboratory use:

- IEC 61010-1, EN 61010-1
- UL 61010-1, CSA 61010-1



Note For UL and other safety certifications, refer to the product label or visit ni.com/certification, search by module number or product line, and click the appropriate link in the Certification column.

Hazardous Locations

U.S. (UL) Class I, Division 2,
Groups A, B, C, D, T4;
Class I, Zone 2,
AEx nC IIC T4

Canada (C-UL)	Class I, Division 2, Groups A, B, C, D, T4; Class I, Zone 2, Ex nC IIC T4
Europe (DEMKO).....	EEx nC IIC T4

Environmental

National Instruments C Series modules are intended for indoor use only but may be used outdoors if installed in a suitable enclosure. Refer to the manual for the chassis you are using for more information about meeting these specifications.

Operating temperature
(IEC 60068-2-1, IEC 60068-2-2) -40 to 70 °C

Storage temperature
(IEC 60068-2-1, IEC 60068-2-2) -40 to 85 °C

Ingress protection..... IP 40

Operating humidity
(IEC 60068-2-56)..... 10 to 90% RH,
noncondensing

Storage humidity (IEC 60068-2-56).....	5 to 95% RH, noncondensing
Maximum altitude.....	2,000 m
Pollution Degree (IEC 60664).....	2

Shock and Vibration

To meet these specifications, you must panel mount the system and use a backshell kit or shielded cable to protect the connections. Use the NI 9940 backshell for the NI 9205 with spring terminal and a 37-pin shielded cable or the NI 9933 backshell for the NI 9205 with DSUB.

Operating vibration

Random (IEC 60068-2-64).....	5 g _{rms} , 10 to 500 Hz
Sinusoidal (IEC 60068-2-6)	5 g, 10 to 500 Hz

Operating shock

(IEC 60068-2-27).....	30 g, 11 ms half sine, 50 g, 3 ms half sine, 18 shocks at 6 orientations
-----------------------	--

Electromagnetic Compatibility

This product is designed to meet the requirements of the following standards of EMC for electrical equipment for measurement, control, and laboratory use:

- EN 61326 EMC requirements; Industrial Immunity
- EN 55011 Emissions; Group 1, Class A
- CE, C-Tick, ICES, and FCC Part 15 Emissions; Class A



Note For EMC compliance, operate this device with shielded cabling.

CE Compliance

This product meets the essential requirements of applicable European directives, as amended for CE markings, as follows:

- 2006/95/EC; Low-Voltage Directive (safety)
- 2004/108/EC; Electromagnetic Compatibility Directive (EMC)



Note Refer to the Declaration of Conformity (DoC) for this product for any additional regulatory compliance information. To obtain the DoC for this product, visit

ni.com/certification, search by module number or product line, and click the appropriate link in the Certification column.

Environmental Management

National Instruments is committed to designing and manufacturing products in an environmentally responsible manner. NI recognizes that eliminating certain hazardous substances from our products is beneficial not only to the environment but also to NI customers.

For additional environmental information, refer to the *NI and the Environment* Web page at ni.com/environment. This page contains the environmental regulations and directives with which NI complies, as well as other environmental information not included in this document.

Waste Electrical and Electronic Equipment (WEEE)



EU Customers At the end of their life cycle, all products *must* be sent to a WEEE recycling center. For more information about WEEE recycling centers and National Instruments WEEE initiatives, visit ni.com/environment/weee.htm.

电子信息产品污染控制管理办法（中国 RoHS）



中国客户 National Instruments 符合中国电子信息产品中限制使用某些有害物质指令 (RoHS)。关于 National Instruments 中国 RoHS 合规性信息，请登录 ni.com/environment/rohs_china。(For information about China RoHS compliance, go to ni.com/environment/rohs_china.)

Calibration (Analog Input)

You can obtain the calibration certificate and information about calibration services for the NI 9205 at ni.com/calibration.

Calibration interval 2 years

Where to Go for Support

The National Instruments Web site is your complete resource for technical support. At ni.com/support you have access to everything from troubleshooting and application development self-help resources to email and phone assistance from NI Application Engineers.

National Instruments corporate headquarters is located at 11500 North Mopac Expressway, Austin, Texas, 78759-3504.

National Instruments also has offices located around the world to help address your support needs. For telephone support in the United States, create your service request at ni.com/support and follow the calling instructions or dial 512 795 8248. For telephone support outside the United States, contact your local branch office:

Australia 1800 300 800, Austria 43 662 457990-0,
Belgium 32 (0) 2 757 0020, Brazil 55 11 3262 3599,
Canada 800 433 3488, China 86 21 5050 9800,
Czech Republic 420 224 235 774, Denmark 45 45 76 26 00,
Finland 358 (0) 9 725 72511, France 01 57 66 24 24,
Germany 49 89 7413130, India 91 80 41190000,
Israel 972 3 6393737, Italy 39 02 41309277, Japan 0120-527196,
Korea 82 02 3451 3400, Lebanon 961 (0) 1 33 28 28,
Malaysia 1800 887710, Mexico 01 800 010 0793,
Netherlands 31 (0) 348 433 466, New Zealand 0800 553 322,
Norway 47 (0) 66 90 76 60, Poland 48 22 3390150,
Portugal 351 210 311 210, Russia 7 495 783 6851,
Singapore 1800 226 5886, Slovenia 386 3 425 42 00,
South Africa 27 0 11 805 8197, Spain 34 91 640 0085,
Sweden 46 (0) 8 587 895 00, Switzerland 41 56 2005151,
Taiwan 886 02 2377 2222, Thailand 662 278 6777,
Turkey 90 212 279 3031, United Kingdom 44 (0) 1635 523545

National Instruments, NI, ni.com, and LabVIEW are trademarks of National Instruments Corporation. Refer to the *Terms of Use* section on ni.com/legal for more information about National Instruments trademarks. Other product and company names mentioned herein are trademarks or trade names of their respective companies. For patents covering National Instruments products, refer to the appropriate location: **Help » Patents** in your software, the `patents.txt` file on your CD, or ni.com/patents.

© 2006–2008 National Instruments Corp. All rights reserved.