



## Artisan Technology Group is your source for quality new and certified-used/pre-owned equipment

- FAST SHIPPING AND DELIVERY
- TENS OF THOUSANDS OF IN-STOCK ITEMS
- EQUIPMENT DEMOS
- HUNDREDS OF MANUFACTURERS SUPPORTED
- LEASING/MONTHLY RENTALS
- ITAR CERTIFIED SECURE ASSET SOLUTIONS

### SERVICE CENTER REPAIRS

Experienced engineers and technicians on staff at our full-service, in-house repair center

### *InstraView*<sup>SM</sup> REMOTE INSPECTION

Remotely inspect equipment before purchasing with our interactive website at [www.instraview.com](http://www.instraview.com) ↗

### WE BUY USED EQUIPMENT

Sell your excess, underutilized, and idle used equipment. We also offer credit for buy-backs and trade-ins. [www.artisanng.com/WeBuyEquipment](http://www.artisanng.com/WeBuyEquipment) ↗

### LOOKING FOR MORE INFORMATION?

Visit us on the web at [www.artisanng.com](http://www.artisanng.com) ↗ for more information on price quotations, drivers, technical specifications, manuals, and documentation

**Contact us:** (888) 88-SOURCE | [sales@artisanng.com](mailto:sales@artisanng.com) | [www.artisanng.com](http://www.artisanng.com)

[Ordering Information](#) | [Detailed Specifications](#)

For user manuals and dimensional drawings, visit the product page resources tab on ni.com.

Last Revised: 2010-06-09 17:21:23.0

## 100 MS/s, 14-Bit Digitizers for Communications

### NI PXI-5142, NI PCI-5142



- 100 MS/s real-time sample rate, up to 2.0 GS/s equivalent-time sample rate
- 14-bit resolution on two simultaneously sampled channels
- 100 MHz analog bandwidth with noise and antialias filters
- Quadrature digital downconversion (DDC) with up to 40 MHz IF bandwidth
- Baseband I/Q decimation with alias protection
- General-purpose alias-protected decimation for all sample rates

### Overview

The NI PCI-5142 and PXI-5142 are 100 MS/s digitizers with onboard signal processing (OSP). OSP functions include quadrature digital downconversion (DDC), real digital downconversion, and antialiasing filtering for baseband I/Q decimation and general-purpose applications. NI 5142 devices are ideal for communications applications, but they are also suited for a wide variety of applications in automotive, scientific research, military/aerospace, and consumer electronics. With the large dynamic range, software-selectable 50  $\Omega$  or 1 M $\Omega$  input, ranges from 200 mV to 20 V, and the ability to acquire more than a half million waveforms in onboard memory, an NI 5142 is ideal for both time- and frequency-domain analysis.

[Back to Top](#)

### Ordering Information

For a complete list of accessories, visit the product page on ni.com.

Products	Part Number	Recommended Accessories	Part Number
<b>NI PCI-5142</b>			
<b>NI PCI-5142/64 MB</b>	779589-01	<b>Cable: Shielded - SMB 112</b>	778827-01
Each NI PCI-5142/64 MB requires: 1 Cable			

<b>NI PCI-5142/256 MB</b> Each NI PCI-5142/256 MB requires: 1 Cable	779589-02	<b>Cable:</b> Shielded - SMB 112	778827-01
<b>NI PXI-5142</b>			
<b>NI PXI-5142/64 MB</b> Each NI PXI-5142/64 MB requires: 1 Cable	779587-01	<b>Cable:</b> Shielded - SMB 112	778827-01
<b>NI PXI-5142/256MB</b> Each NI PXI-5142/256MB requires: 1 Cable	779587-02	<b>Cable:</b> Shielded - SMB 112	778827-01

[Back to Top](#)

## Support and Services

### System Assurance Programs

NI system assurance programs are designed to make it even easier for you to own an NI system. These programs include configuration and deployment services for your NI PXI, CompactRIO, or Compact FieldPoint system. The NI Basic System Assurance Program provides a simple integration test and ensures that your system is delivered completely assembled in one box. When you configure your system with the NI Standard System Assurance Program, you can select from available NI system driver sets and application development environments to create customized, reorderable software configurations. Your system arrives fully assembled and tested in one box with your software preinstalled. When you order your system with the standard program, you also receive system-specific documentation including a bill of materials, an integration test report, a recommended maintenance plan, and frequently asked question documents. Finally, the standard program reduces the total cost of owning an NI system by providing three years of warranty coverage and calibration service. Use the online product advisors at [ni.com/advisor](http://ni.com/advisor) to find a system assurance program to meet your needs.

### Calibration

NI measurement hardware is calibrated to ensure measurement accuracy and verify that the device meets its published specifications. NI offers a number of calibration services to help maintain the ongoing accuracy of your measurement hardware. These services allow you to be completely confident in your measurements, and help you maintain compliance to standards like ISO 9001, ANSI/NCSL Z540-1 and ISO/IEC 17025. To learn more about NI calibration services or to locate a qualified service center near you, contact your local sales office or visit [ni.com/calibration](http://ni.com/calibration).

### Technical Support

Get answers to your technical questions using the following National Instruments resources.

- **Support** - Visit [ni.com/support](http://ni.com/support) to access the NI KnowledgeBase, example programs, and tutorials or to contact our applications engineers who are located in NI sales offices around the world and speak the local language.
- **Discussion Forums** - Visit [forums.ni.com](http://forums.ni.com) for a diverse set of discussion boards on topics you care about.
- **Online Community** - Visit [community.ni.com](http://community.ni.com) to find, contribute, or collaborate on customer-contributed technical content with users like you.

### Repair

While you may never need your hardware repaired, NI understands that unexpected events may lead to necessary repairs. NI offers repair services performed by highly trained technicians who quickly return your device with the guarantee that it will perform to factory specifications. For more information, visit [ni.com/repair](http://ni.com/repair).

### Training and Certifications

The NI training and certification program delivers the fastest, most certain route to increased proficiency and productivity using NI software and hardware. Training builds the skills to more efficiently develop robust, maintainable applications, while certification validates your knowledge and ability.

- **Classroom training in cities worldwide** - the most comprehensive hands-on training taught by engineers.
- **On-site training at your facility** - an excellent option to train multiple employees at the same time.
- **Online instructor-led training** - lower-cost, remote training if classroom or on-site courses are not possible.
- **Course kits** - lowest-cost, self-paced training that you can use as reference guides.
- **Training memberships** and training credits - to buy now and schedule training later.

Visit [ni.com/training](http://ni.com/training) for more information.

### Extended Warranty

NI offers options for extending the standard product warranty to meet the life-cycle requirements of your project. In addition, because NI understands that your requirements may change, the extended warranty is flexible in length and easily renewed. For more information, visit [ni.com/warranty](http://ni.com/warranty).

## OEM

NI offers design-in consulting and product integration assistance if you need NI products for OEM applications. For information about special pricing and services for OEM customers, visit [ni.com/oem](http://ni.com/oem).

## Alliance

Our Professional Services Team is comprised of NI applications engineers, NI Consulting Services, and a worldwide National Instruments Alliance Partner program of more than 600 independent consultants and integrators. Services range from start-up assistance to turnkey system integration. Visit [ni.com/alliance](http://ni.com/alliance).

[Back to Top](#)

## Detailed Specifications

### 14-Bit 100 MS/s Digitizer with Onboard Signal Processing

This topic lists the specifications for the NI PXI/PCI-5142 (NI 5142) high-speed digitizer. Unless otherwise noted, the following conditions were used for each specification:

- All filter settings
- All impedance selections
- Sample clock set to 100 MS/s

Typical values are used to define an average unit measured at ambient temperatures of 15 °C to 35 °C. Specifications are subject to change without notice. For the most recent NI 5142 specifications, visit [ni.com/manuals](http://ni.com/manuals).

To access NI 5142 documentation, navigate to **Start»All Programs»National Instruments»NI-SCOPE»Documentation**.



**Hot Surface** If the NI 5142 has been in use, the device or the shield may exceed safe handling temperatures and may cause burns. Allow the NI 5142 to cool before touching the shield or removing the device from the chassis or PC. Refer to the *Environment* section for operating temperatures.

Vertical					
Analog Input (Channel 0 and Channel 1)					
Specification	Value				Comments
Number of Channels	Two (simultaneously sampled)				—
Connector	BNC				—
Impedance and Coupling					
Input Impedance	50 Ω ±2.0%	1 MΩ ±0.75% in parallel with a typical capacitance of 27 pF ±2 pF		Software selectable.	
Input Coupling	AC, DC, GND				AC coupling available on 1 MΩ only.
Voltage Levels					
Full Scale (FS) Input Range and Programmable Vertical Offset	50 Ω		1 MΩ		—
	Range (V <sub>pk-pk</sub> )	Vertical Offset Range (V)	Range (V <sub>pk-pk</sub> )	Vertical Offset Range (V)	
	0.2	±0.1	0.2	±0.1	
	0.4	±0.2	0.4	±0.2	
	1	±0.5	1	±0.5	
	2	±1	2	±1	
	4	±2	4	±2	
	10	—	10	±5	
		20	—		
Maximum Input Overload	50 Ω		1 MΩ		—

		7 V <sub>rms</sub> with  Peaks  ≤10 V	Peaks  ≤42 V	
<b>Accuracy</b>				
Resolution	14 bits		—	
DC Accuracy (Programmable Vertical Offset = 0 V)	Range (V <sub>pk-pk</sub> )	50 Ω and 1 MΩ		Within ±5 °C of self-calibration temperature.
	0.2, 0.4	NI PXI-5142: ±(0.65% of Input + 1.0 mV) NI PCI-5142: ±(0.65% of Input + 2.0 mV)		
	1	NI PXI-5142: ±(0.65% of Input + 1.2 mV) NI PCI-5142: ±(0.65% of Input + 2.0 mV)		
	2	NI PXI-5142: ±(0.65% of Input + 1.6 mV) NI PCI-5142: ±(0.65% of Input + 2.2 mV)		
	4	NI PXI/PCI-5142: ±(0.65% of Input + 8.0 mV)		
	10	NI PXI-5142: ±(0.65% of Input + 8.0 mV) NI PCI-5142: ±(0.65% of Input + 10.0 mV)		
	20 (1 MΩ only)	NI PXI-5142: ±(0.65% of Input + 13.0 mV) NI PCI-5142: ±(0.65% of Input + 15.0 mV)		
	Programmable Vertical Offset Accuracy	±0.4% of offset setting		
DC Drift	Range (V <sub>pk-pk</sub> )	50 Ω and 1 MΩ		—
	0.2, 0.4, 1, and 2	±(0.057% of Input + 0.006% of FS + 100 μV) per °C		
	4, 10, and 20 (1 MΩ only)	±(0.057% of Input + 0.006% of FS + 900 μV) per °C		
AC Amplitude Accuracy	50 Ω	1 MΩ		Within ±5 °C of self-calibration temperature.
	±0.06 dB (±0.7%) at 50 kHz		±0.09 dB (±1.0%) at 50 kHz	
Crosstalk, Typical	≤-100 dB at 10 MHz		CH 0 to/from CH 1, External Trigger to CH 0 or CH 1.	
<b>Bandwidth and Transient Response</b>				
Bandwidth (-3 dB)	Range (V <sub>pk-pk</sub> )	50 Ω and 1 MΩ		Filters off. * 78 MHz above 40 °C.
	All ranges except 0.2	100 MHz		
	0.2	80 MHz up to 40 °C*		
Rise/Fall Time, Typical	Range (V <sub>pk-pk</sub> )	50 Ω and 1 MΩ		—
	All ranges except 0.2	3.5 ns		
	0.2	4.2 ns		
Bandwidth Limit Filters	Noise Filter	Antialias Filter		Only one filter can be enabled at any given time. The antialias filter is enabled by default.
	20 MHz	40 MHz (-6 dB, typical) 35 MHz (-3 dB)		
	2-pole Bessel filter	6-pole Chebyshev filter		
AC Coupling Cutoff (-3 dB)	12 Hz		AC coupling available on 1 MΩ only.	
Passband Flatness	Filter Settings	Range (V <sub>pk-pk</sub> )	50 Ω and 1 MΩ	
	Referenced to 50 kHz.			

Filters Off	All ranges except 0.2	±0.4 dB DC to 20 MHz ±1 dB 20 MHz to 50 MHz
	0.2	±0.4 dB DC to 20 MHz ±1 dB 20 MHz to 40 MHz
Antialias Filter On	All ranges	±1.2 dB DC to 16 MHz ±1.6 dB 16 MHz to 32 MHz

### NI 5142 Frequency Response (Typical)

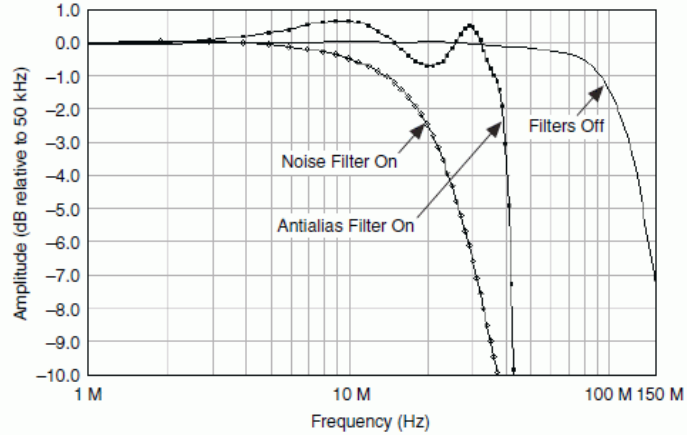

Specification	Value			Comments
<b>Spectral Characteristics</b>				
Spurious-Free Dynamic Range with Harmonics (SFDR), Typical	Range (V <sub>pk-pk</sub> )	50 Ω	1 MΩ	10 MHz, -1 dBFS input signal.
	0.2	75 dBc	70 dBc	Includes the 2 <sup>nd</sup> through the 5 <sup>th</sup> harmonics.
	0.4	75 dBc	70 dBc	Measured from DC to 50 MHz on NI PXI-5142.
	1	75 dBc	70 dBc	Measured from 5 kHz to 50 MHz on NI PCI-5142.
	2	75 dBc	70 dBc	
	4	65 dBc	70 dBc	
	10	65 dBc	60 dBc	
	20 (1 MΩ only)	N/A	60 dBc	
Total Harmonic Distortion (THD), Typical	Range (V <sub>pk-pk</sub> )	50 Ω	1 MΩ	10 MHz, -1 dBFS input signal.
	0.2	-75 dBc	-68 dBc	Includes the 2 <sup>nd</sup> through the 5 <sup>th</sup> harmonics.
	0.4	-75 dBc	-68 dBc	
	1	-75 dBc	-68 dBc	
	2	-73 dBc	-68 dBc	
	4	-63 dBc	-68 dBc	
	10	-63 dBc	-58 dBc	
	20 (1 MΩ only)	N/A	-58 dBc	
Intermodulation Distortion, Typical	0.2 V <sub>pk-pk</sub> to 2.0 V <sub>pk-pk</sub> Ranges on 50 Ω Input			Two tones at 10.2 MHz and 11.2 MHz. Each tone is -7 dBFS.
	-75 dBc			

Signal-to-Noise Ratio (SNR), Typical	Range (V <sub>pk-pk</sub> )	50 Ω		1 MΩ		10 MHz, -1 dBFS input signal. Excludes harmonics. Measured from DC to 50 MHz.
		Filters Off	Antialias Filter On	Filters Off	Antialias Filter On	
	0.2	60 dB	60 dB	56 dB	60 dB	
	0.4	62 dB	62 dB	61 dB	62 dB	
	1	62 dB	62 dB	62 dB	62 dB	
	2	62 dB	62 dB	62 dB	62 dB	
	4	—	—	61 dB	62 dB	
Signal to Noise and Distortion (SINAD), Typical	Range (V <sub>pk-pk</sub> )	50 Ω		1 MΩ		10 MHz, -1 dBFS input signal. Includes harmonics. Measured from DC to 50 MHz.
		Filters Off	Antialias Filter On	Filters Off	Antialias Filter On	
	0.2	60 dB	60 dB	56 dB	59 dB	
	0.4	62 dB	62 dB	60 dB	61 dB	
	1	62 dB	62 dB	61 dB	61 dB	
	2	62 dB	62 dB	61 dB	61 dB	
	4	—	—	60 dB	61 dB	

**NI 5142 Dynamic Performance, 50 Ω, 1 V<sub>pk-pk</sub> Range (Typical)**

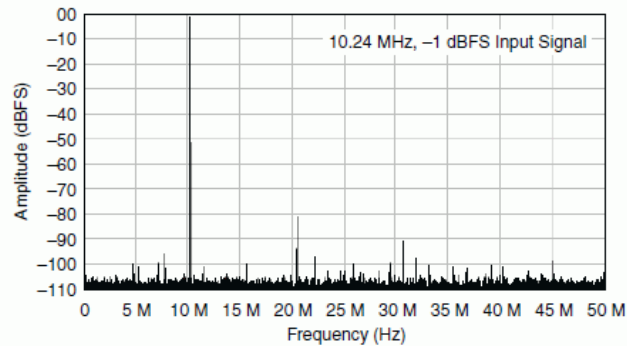

Specification	Value		Comments	
RMS Noise (Noise Filter On)	Range (V <sub>pk-pk</sub> )	50 Ω	1 MΩ	50 Ω terminator connected to input.
	0.2	NI PXI-5142: 46 μV <sub>rms</sub> (0.023% FS)	NI PXI-5142: 60 μV <sub>rms</sub> (0.030% FS)	
		NI PCI-5142: 56 μV <sub>rms</sub> (0.028% FS)	NI PCI-5142: 72 μV <sub>rms</sub> (0.036% FS)	
	0.4	92 μV <sub>rms</sub> (0.023% FS)	92 μV <sub>rms</sub> (0.023% FS)	
	1	230 μV <sub>rms</sub> (0.023% FS)	230 μV <sub>rms</sub> (0.023% FS)	
	2	460 μV <sub>rms</sub> (0.023% FS)	460 μV <sub>rms</sub> (0.023% FS)	
	4	920 μV <sub>rms</sub> (0.023% FS)	920 μV <sub>rms</sub> (0.023% FS)	
	10	2.3 mV <sub>rms</sub> (0.023% FS)	2.3 mV <sub>rms</sub> (0.023% FS)	
20 (1 MΩ only)	N/A	4.6 mV <sub>rms</sub> (0.023% FS)		
Specification	Value		Comments	
RMS Noise (Antialias Filter On)	Range (V <sub>pk-pk</sub> )	50 Ω	1 MΩ	50 Ω terminator connected to input.
	0.2			

		NI PXI-5142: 66 $\mu\text{V}_{\text{rms}}$ (0.033% FS) NI PCI-5142: 82 $\mu\text{V}_{\text{rms}}$ (0.041% FS)	NI PXI-5142: 80 $\mu\text{V}_{\text{rms}}$ (0.040% FS) NI PCI-5142: 96 $\mu\text{V}_{\text{rms}}$ (0.048% FS)	
	0.4	100 $\mu\text{V}_{\text{rms}}$ (0.025% FS)	120 $\mu\text{V}_{\text{rms}}$ (0.030% FS)	
	1	250 $\mu\text{V}_{\text{rms}}$ (0.025% FS)	300 $\mu\text{V}_{\text{rms}}$ (0.030% FS)	
	2	500 $\mu\text{V}_{\text{rms}}$ (0.025% FS)	600 $\mu\text{V}_{\text{rms}}$ (0.030% FS)	
	4	1 $\text{mV}_{\text{rms}}$ (0.025% FS)	1.2 $\text{mV}_{\text{rms}}$ (0.030% FS)	
	10	2.5 $\text{mV}_{\text{rms}}$ (0.025% FS)	3 $\text{mV}_{\text{rms}}$ (0.030% FS)	
	20 (1 $\text{M}\Omega$ only)	N/A	6 $\text{mV}_{\text{rms}}$ (0.030% FS)	
Specification	Value			Comments
RMS Noise (Filters Off)	Range ( $\text{V}_{\text{pk-pk}}$ )	50 $\Omega$	1 $\text{M}\Omega$	50 $\Omega$ terminator connected to input.
	0.2	NI PXI-5142: 66 $\mu\text{V}_{\text{rms}}$ (0.033% FS) NI PCI-5142: 90 $\mu\text{V}_{\text{rms}}$ (0.045% FS)	110 $\mu\text{V}_{\text{rms}}$ (0.055% FS)	
	0.4	100 $\mu\text{V}_{\text{rms}}$ (0.025% FS)	160 $\mu\text{V}_{\text{rms}}$ (0.040% FS)	
	1	250 $\mu\text{V}_{\text{rms}}$ (0.025% FS)	300 $\mu\text{V}_{\text{rms}}$ (0.030% FS)	
	2	500 $\mu\text{V}_{\text{rms}}$ (0.025% FS)	600 $\mu\text{V}_{\text{rms}}$ (0.030% FS)	
	4	1 $\text{mV}_{\text{rms}}$ (0.025% FS)	1.6 $\text{mV}_{\text{rms}}$ (0.040% FS)	
	10	2.5 $\text{mV}_{\text{rms}}$ (0.025% FS)	3 $\text{mV}_{\text{rms}}$ (0.030% FS)	
	20 (1 $\text{M}\Omega$ only)	N/A	6 $\text{mV}_{\text{rms}}$ (0.030% FS)	

Representation of NI 5142 Spectral Noise Density on 0.2 V Range, Noise Filter Enabled, 1  $\text{M}\Omega$  Input Impedance

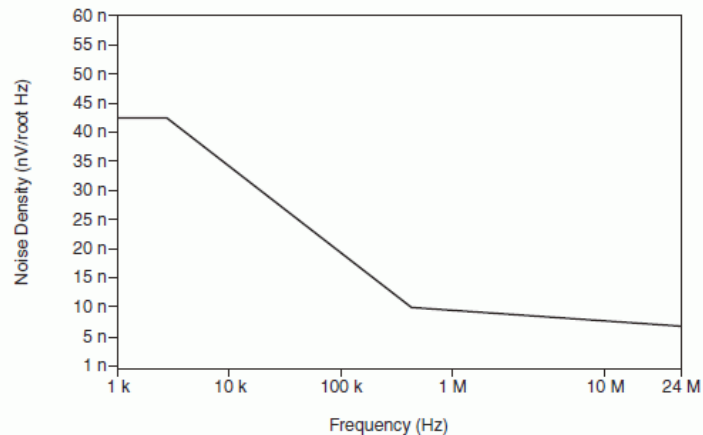

Representation of NI 5142 Spectral Noise Density on 0.2 V Range, Full Bandwidth, 50  $\Omega$  Input Impedance



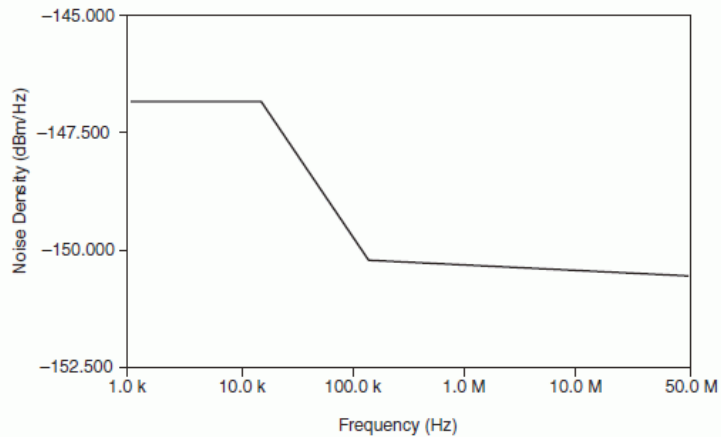

## Horizontal

### Sample Clock

Specification	Value		Comments
Sources	NI PXI-5142 Internal, Onboard Clock (internal VCXO)* External, CLK IN (front panel SMB connector) External, PXI Star Trigger (backplane connector)	NI PCI-5142 Internal, Onboard Clock (internal VCXO)* External, CLK IN (front panel SMB connector)	* Internal Sample Clock is locked to the Reference Clock or derived from the onboard VCXO.
<b>Onboard Clock (Internal VCXO)</b>			
Sample Rate Range	Real-Time Sampling (Single Shot) 1.526 kS/s to 100 MS/s*	Random Interleaved Sampling (RIS) 200 MS/s to 2 GS/s in multiples of 100 MS/s	* In normal operation mode (non-OSP mode), divide by n decimation is used for all rates less than 100 MS/s. For more information about Sample Clock and decimation, refer to the <i>NI High-Speed Digitizers Help</i> . Non-OSP decimation does not protect the acquired data from undersampling aliasing. Non-OSP decimation and OSP decimation are mutually exclusive.
Phase Noise Density, Typical	<-100 dBc/Hz at 100 Hz <-120 dBc/Hz at 1 kHz <-130 dBc/Hz at 10 kHz		10 MHz input signal.
Sample Clock Jitter, Typical	≤1 ps rms (100 Hz to 100 kHz) ≤2 ps rms (100 Hz to 1 MHz)		Includes the effects of the converter aperture uncertainty and the clock circuitry jitter. Excludes trigger jitter.
Timebase Frequency	100 MHz		—
Timebase Accuracy	Not Phase-Locked to Reference Clock ±25 ppm	Phase-Locked to Reference Clock Equal to the Reference Clock accuracy	ppm = parts per million ( $1 \times 10^{-6}$ )
Sample Clock Delay Range	±1 Sample Clock period		—

Sample Clock Delay Resolution	≤10 ps	—	
<b>External Sample Clock</b>			
Sources	NI PXI-5142	NI PCI-5142	—
	CLK IN (front panel SMB connector)	CLK IN (front panel SMB connector)	
	PXI Star Trigger (backplane connector)		
Frequency Range	30 MHz to 105 MHz (CLK IN) 30 MHz to 80 MHz (PXI Star Trigger)	In normal operation mode (non-OSP mode), divide by $n$ decimation is available where $1 \leq n \leq 65,535$ . For more information about Sample Clock and decimation, refer to the <i>NI High-Speed Digitizers Help</i> . Non-OSP decimation does not protect the acquired data from undersampling aliasing. Non-OSP decimation and OSP decimation are mutually exclusive.	
Duty Cycle Tolerance	45% to 55%	—	
<b>Sample Clock Exporting</b>			
Exported Sample Clock Destinations	Destination	Maximum Frequency	* Decimated Sample Clock only.
	CLK OUT (front panel SMB connector)	105 MHz	
	PXI_Trig <0..6> (backplane connector)*	20 MHz	
	PFI <0..1> (front panel 9-pin mini-circular DIN connector)*	25 MHz	
	RTSI<0..6>*	20 MHz	

#### Phase-Locked Loop (PLL) Reference Clock

Specification	Value		Comments
Sources	NI PXI-5142	NI PCI-5142	—
	PXI_CLK10 (backplane connector)	RTSI 7	
	CLK IN (front panel SMB connector)	CLK IN (front panel SMB connector)	
Frequency Range	1 MHz to 20 MHz in 1 MHz increments. Default of 10 MHz. The PLL Reference Clock frequency has to be accurate to ±50 ppm.		—
Duty Cycle Tolerance	45% to 55%		—
Exported Reference Clock Destinations	NI PXI-5142	NI PCI-5142	—
	CLK OUT (front panel SMB connector)	CLK OUT (front panel SMB connector)	
	PFI <0..1> (front panel 9-pin mini-circular DIN connector)	PFI <0..1> (front panel 9-pin mini-circular DIN connector)	
	PXI_Trig <0..7> (backplane connector)	RTSI <0..7>	

#### CLK IN (Sample Clock and Reference Clock Input, Front Panel Connector)

Specification	Value	Comments
Input Voltage Range	Sine wave: $0.65 V_{pk-pk}$ to $2.8 V_{pk-pk}$ (0 dBm to 13 dBm)	—
	Square wave: $0.2 V_{pk-pk}$ to $2.8 V_{pk-pk}$	

Maximum Input Overload	7 V <sub>rms</sub> with  Peaks  ≤10 V	Overvoltage and reverse polarity protected.
Impedance	50 Ω	—
Coupling	AC	—

#### CLK OUT (Sample Clock and Reference Clock Output, Front Panel Connector)

Specification	Value	Comments
Output Impedance	50 Ω	—
Logic Type	3.3 V CMOS	—
Maximum Drive Current	±48 mA	—

### Trigger

#### Reference (Stop) Trigger

Specification	Value		Comments
Trigger Types and Sources	Types	Sources	Refer to the following sections and the <i>NI High-Speed Digitizers Help</i> for more information about what sources are available for each trigger type.
	Edge, Window, Hysteresis, Video, Digital, Immediate, and Software	CH 0, CH 1, TRIG, PXI_Trig <0..6>, PFI <0..1>, PXI Star Trigger, Software, and RTSI <0..6>	
Time Resolution	TDC	Onboard Clock	TDC = Time to Digital Conversion Circuit.
	On	100 ps	
	Off	10 ns	
Minimum Rearm Time	TDC	Rearm Time	Holdoff set to 0. Onboard sample clock at maximum rate.
	On	10 μs	
	Off	2 μs	
Holdoff	TDC	Onboard Clock	—
	On	10 μs to 171.79 s	
	Off	2 μs to 171.79 s	
		200 × (External Clock Period) to (2 <sup>32</sup> - 1) × (External Clock Period)	

#### Analog Trigger (Edge, Window, and Hysteresis Trigger Types)

Sources	CH 0 (front panel BNC connector) CH 1 (front panel BNC connector) TRIG (front panel BNC connector)	—
Trigger Level Range	CH 0, CH 1	TRIG (External Trigger)
	100% FS	±5 V
Trigger Level Resolution	10 bits (1 in 1,024)	—
Edge Trigger Sensitivity	CH 0, CH 1	TRIG (External Trigger)
	2.5% FS up to 50 MHz, increasing to 5% FS at 100 MHz	0.25 V <sub>pk-pk</sub> up to 100 MHz, increasing to 1 V <sub>pk-pk</sub> at 200 MHz
Level Accuracy, Typical	CH 0, CH 1	TRIG (External Trigger)
	±3.5% FS up to 10 MHz	±0.35 V (±3.5% FS) up to 10 MHz
Jitter	≤80 ps rms	Within ±5 °C of self-calibration temperature.
Trigger Filters	Low-Frequency (LF) Reject	High-Frequency (HF) Reject

	50 kHz	50 kHz	
<b>Digital Trigger (Digital Trigger Type)</b>			
Sources	NI PXI-5142 PXI_Trig <0..6> (backplane connector) PFI<0..1> (front panel 9-pin mini-circular DIN connector) PXI Star Trigger (backplane connector)	NI PCI-5142 RTSI <0..6> PFI<0..1> (front panel 9-pin mini-circular DIN connector)	—
<b>Video Trigger (Video Trigger Type)</b>			
Sources	CH 0 (front panel BNC connector) CH 1 (front panel BNC connector) TRIG (front panel BNC connector)		—
Types	Specific Line Any Line Specific Field		—
Standard	Negative sync of NTSC, PAL, or SECAM signal		—

#### TRIG (External Trigger, Front Panel Connector)

Specification	Value
Connector	BNC
Impedance	1 MΩ in parallel with 22 pF
Coupling	AC, DC
AC Coupling Cutoff (-3 dB)	12 Hz
Input Voltage Range	±5 V
Maximum Input Overload	Peaks  ≤42 V

#### PFI 0 and PFI 1 (Programmable Function Interface, AUX Front Panel Connectors)

Specification	Value
Connector	9-pin mini-circular DIN
Direction	Bi-directional
<b>As an Input (Trigger)</b>	
Destinations	Start Trigger (Acquisition Arm) Reference (Stop) Trigger Arm Reference Trigger Advance Trigger
Input Impedance	150 kΩ
V <sub>IH</sub>	2.0 V
V <sub>IL</sub>	0.8 V
Maximum Input Overload	-0.5 V, 5.5 V

Maximum Frequency	25 MHz
<b>As an Output (Event)</b>	
Sources	Ready for Start Start Trigger (Acquisition Arm) Ready for Reference Reference (Stop) Trigger End of Record Ready for Advance Advance Trigger Done (End of Acquisition) Probe Compensation (1 kHz, 50% duty cycle square wave, PFI 1 only)
Output Impedance	50 $\Omega$
Logic Type	3.3 V CMOS
Maximum Drive Current	$\pm 24$ mA
Maximum Frequency	25 MHz

### TCIk Specifications

National Instruments TCIk synchronization method and the NI-TCIk driver are used to align the sample clocks on any number of SMC-based modules in a chassis. For more information about TCIk synchronization, refer to the *NI-TCIk Synchronization Help*, which is located within the *NI High-Speed Digitizers Help*.

- Specifications are valid for any number of modules installed in one NI PXI-1042 chassis.
- All parameters set to identical values for each SMC-based module.
- Sample Clock set to 100 MS/s and all filters are disabled.
- For other configurations, including multichassis systems, contact NI Technical Support at [ni.com/support](http://ni.com/support).



**Note** Although you can use NI-TCIk to synchronize non-identical modules, these specifications apply only to synchronizing identical modules.

Specification	Value	Comments
<b>Intermodule SMC Synchronization Using NI-TCIk for Identical Modules (Typical)</b>		
Skew	500 ps	Caused by clock and analog path delay differences. No manual adjustment performed.
Average Skew After Manual Adjustment	$\leq 5$ ps	For information about manual adjustment, refer to the <i>Synchronization Repeatability Optimization</i> topic in the <i>NI-TCIk Synchronization Help</i> . For additional help with the adjustment process, contact NI Technical Support at <a href="http://ni.com/support">ni.com/support</a> .
Sample Clock Delay/Adjustment Resolution	$\leq 5$ ps	—

### Waveform Specifications

Specification	Value		Comments
Onboard Memory Size	64 MB per Channel Option	32 megasamples per channel*	*Assumes 2-byte samples. In Complex data processing mode (only available when using onboard signal processing), each sample is 4 bytes, so this number is halved.
	256 MB per Channel Option	128 megasamples per channel*	
Minimum Record Length	1 Sample		—
Number of Pretrigger Samples	Zero up to full Record Length		Single-record mode and multiple-record mode.

Number of Posttrigger Samples	Zero up to full Record Length		Single-record mode and multiple-record mode.
Maximum Number of Records in Onboard Memory	64 MB/channel	100,000 <sup>†</sup>	<sup>†</sup> It is possible to exceed these numbers if you fetch records while acquiring data. For more information, refer to the <i>NI High-Speed Digitizers Help</i> .
	256 MB/channel	100,000 <sup>†</sup>	
Allocated Onboard Memory per Record	Real Data Processing Mode	Complex Data Processing Mode	—
	$(Record\ Length \times 2\ bytes/S) + 200\ bytes$ , rounded up to next multiple of 128 bytes or 512 bytes, whichever is greater	$(Record\ Length \times 4\ bytes/S) + 200\ bytes$ , rounded up to next multiple of 128 bytes or 512 bytes, whichever is greater	

## Onboard Signal Processing (OSP)

### NI 5142 Onboard Signal Processing Block Diagram

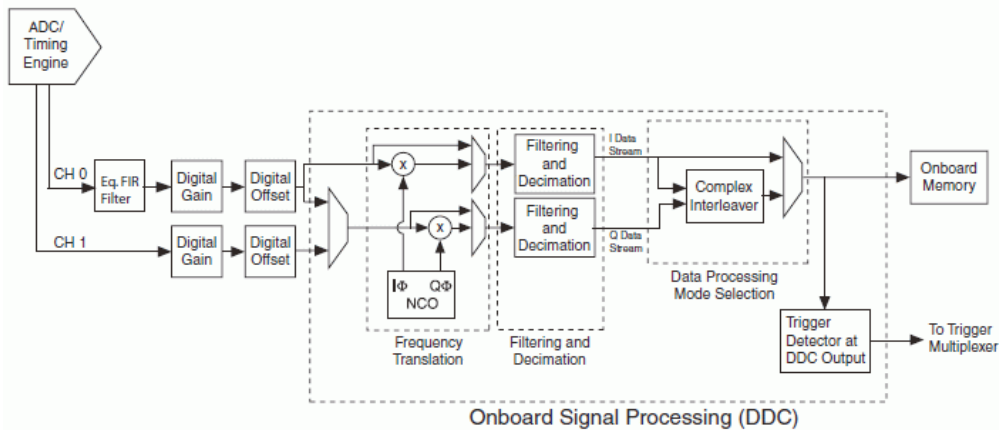

**Note** To use onboard signal processing (OSP) on the NI 5142, the DDC Enabled property/attribute must be set to TRUE.

The following four OSP operations are available:

- Send one IF signal to CH 0 and perform quadrature downconversion on the signal (complex data is returned).
- Send I and Q baseband signals to CH 0 and CH 1 and perform alias-protected decimation (complex data is returned).
- Send a signal to CH 0 and perform alias-protected decimation (real data is returned).
- Send a signal to CH 0 and perform real downconversion on the signal (real data is returned).

Specification	Value	Comments
<b>OSP General</b>		
Number of Digital Downconverters (DDCs)	1	—
Data Processing Modes	Real (I path only) Complex (IQ)	Complex mode is used for both IQ baseband decimation and quadrature downconversion.
OSP Decimation Range	1, 2, 4, 6, 8, 10 12 to 4,096 (Multiples of 4) 4,096 to 8,192 (Multiples of 8) 8,192 to 16,384 (Multiples of 16)	OSP decimation protects acquired data from high-frequency aliasing within the ADC Nyquist zone, whereas non-OSP decimation does not. Non-OSP decimation and OSP decimation are mutually exclusive.

Sample Rate Range	Internal Sample Clock Timebase	External Sample Clock Timebase	For sample rates less than 6.1 kS/s, use an external sample clock or perform additional software decimation.
	6.1 kS/s – 100 MS/s (Real or Complex)	Sample Clock Timebase/OSP Decimation	
Bandwidth	Real Flat Bandwidth = $0.4 \times \text{Sample Rate}$ Complex Flat Bandwidth = $0.8 \times \text{Sample Rate}$		Example: Complex bandwidth is 40 MHz with a Complex Sample Rate of 50 MS/s.
<b>Digital Gain and Offset</b>			
Digital Gain and Offset Resolution	18 bits		—
Digital Gain Range	-1.5 to +1.5   Values   <1 attenuate user data		—
Digital Offset Range	(-0.4 × Vertical Range) to (+0.4 × Vertical Range)		Applied after Digital Gain.
Output	(ADC Data × Digital Gain) + Digital Offset		(-0.5 × Vertical Range) ≤ Output ≤ (+0.5 × Vertical Range)
<b>Numerically-Controlled Oscillator (NCO)</b>			
Frequency Range	Internal Sample Clock Timebase	External Sample Clock Timebase	Undersampling can be used for carrier frequencies >50 MHz.
	0 – 50 MHz	0 Hz to (0.5 × Sample Clock Timebase)	
Frequency Resolution	355 nHz	Sample Clock Timebase / 2 <sup>48</sup>	—
I and Q Phase Resolution	0.0055 °		—
Tuning Time	1 ms		—
<b>Digital Performance</b>			
Maximum NCO Spur	<-100 dBFS		—
Decimating Filter Passband Ripple	<0.1 dB		Passband is from 0 to (0.4 × IQ Rate).
Decimating Filter Out-of-Band Suppression	>80 dB		Stopband suppression from (0.6 × IQ Rate).

Specification	Value	Comments
<b>IF Demodulation Performance (Typical)</b>		
Modulation Configuration	Measurement Type	Value
GSM Physical Layer 1, 2, 8	Modulation Error Ratio (MER)	62 dB
	Error Vector Magnitude (EVM)	<0.2% rms
W-CDMA Physical Layer 1, 3, 8	Modulation Error Ratio (MER)	52 dB
	Error Vector Magnitude (EVM)	<0.4% rms
DVB Physical Layer 1, 4, 8	Modulation Error Ratio (MER)	48 dB
	Error Vector Magnitude (EVM)	<0.4% rms
20 MSymbols/s, 64 QAM 1, 5, 8	Modulation Error Ratio (MER)	39 dB
	Error Vector Magnitude (EVM)	<0.8% rms

26.09 MSymbols/s, 64 QAM <sup>1, 6, 8</sup>	Modulation Error Ratio (MER)	36 dB	30 MHz bandwidth
	Error Vector Magnitude (EVM)	<1.0% rms	
34.78 MSymbols/s 64 QAM <sup>1, 7, 8</sup>	Modulation Error Ratio (MER)	32 dB	40 MHz bandwidth
	Error Vector Magnitude (EVM)	<1.6% rms	

<sup>1</sup> Vertical Range = 1 V<sub>pk-pk</sub><sup>1</sup> Input Impedance = 50 Ω, no analog filter, 25 MHz carrier

<sup>2</sup> Sample Rate = 1.25 MS/s, MSK modulation, 270.833 kSymbols/s, Gaussian, BT = 0.3

<sup>3</sup> Sample Rate = 6.25 MS/s, QPSK modulation, 3.84 MSymbols/s, root raised cosine, alpha = 0.22

<sup>4</sup> Sample Rate = 10 MS/s, 32 QAM modulation, 6.92 MSymbols/s, root raised cosine, alpha = 0.15

<sup>5</sup> Sample Rate = 50 MS/s, 64 QAM modulation, 20 MSymbols/s, root raised cosine, alpha = 0.15

<sup>6</sup> Sample Rate = 50 MS/s, 64 QAM Modulation, 26.09 MSymbols/s, root raised cosine, alpha = 0.15

<sup>7</sup> Sample Rate = 50 MS/s, 64 QAM Modulation, 34.78 MSymbols/s, root raised cosine, alpha = 0.15

<sup>8</sup> Demodulation, including resampling (sample rate conversion) and pulse shaping, was done with the NI Modulation Toolkit in the host PC/controller.

Specification	Value		Comments
<b>IQ Baseband Demodulation Performance (Typical)</b>			
Modulation Configuration	Measurement Type	Value	—
GSM Physical Layer <sup>1, 2, 6, 7</sup>	Modulation Error Ratio (MER)	41 dB	—
	Error Vector Magnitude (EVM)	<0.8% rms	
W-CDMA Physical Layer <sup>1, 3, 6, 7</sup>	Modulation Error Ratio (MER)	41 dB	—
	Error Vector Magnitude (EVM)	<0.9% rms	
DVB Physical Layer <sup>1, 4, 6, 7</sup>	Modulation Error Ratio (MER)	40 dB	—
	Error Vector Magnitude (EVM)	<0.9% rms	
20 MSymbols/s 64 QAM <sup>1, 5, 6, 7</sup>	Modulation Error Ratio (MER)	33 dB	—
	Error Vector Magnitude (EVM)	<1.4% rms	

<sup>1</sup> Vertical Range = 1 V<sub>pk-pk</sub><sup>1</sup> Input Impedance = 50 Ω, no analog filter

<sup>2</sup> Sample Rate = 1.25 MS/s, MSK modulation, 270.833 kSymbols/s, Gaussian, BT = 0.3

<sup>3</sup> Sample Rate = 6.25 MS/s, QPSK modulation, 3.84 MSymbols/s, root raised cosine, alpha = 0.22

<sup>4</sup> Sample Rate = 10 MS/s, 32 QAM modulation, 6.92 MSymbols/s, root raised cosine, alpha = 0.15

<sup>5</sup> Sample Rate = 50 MS/s, 64 QAM modulation, 20 MSymbols/s, root raised cosine, alpha = 0.15

<sup>6</sup> Demodulation, including resampling (sample rate conversion) and pulse shaping, done with the NI Modulation Toolkit in the host PC/controller.

<sup>7</sup> This is a measurement of system performance. The IQ Baseband generation was implemented with two TCik synchronized NI PXI-5421 arbitrary waveform generators.

Specification	Value		Comments
<b>Waveform Acquisition Times</b>			
Maximum Acquisition Time	64 MB	256 MB	For Complex (IQ) mode, the acquisition time is halved.
Sample Rate = 100 MS/s, OSP Disabled	0.336 s	1.34 s	
Sample Rate = 1 MS/s, Real Mode, OSP Enabled	33.6 s	2 min, 14 s	
Sample Rate = 100 kS/s, Real Mode, OSP Enabled	5 min, 36 s	22 min, 22 s	

**Decimation Filter Frequency Response (Real Mode), Sample Rate = 10 MS/s**



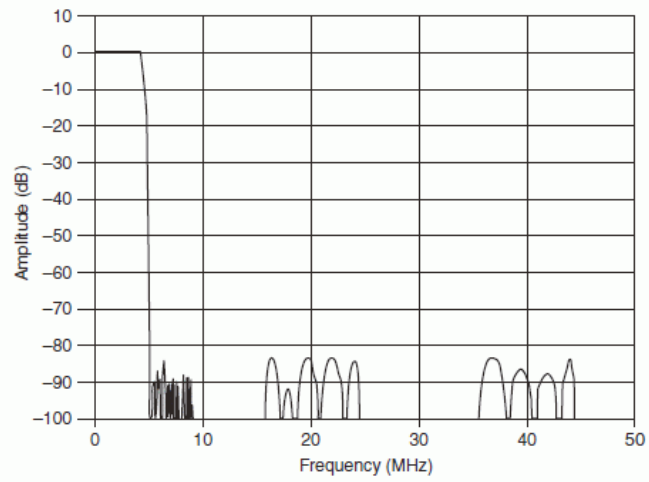

**GSM Physical Layer 1, 2**

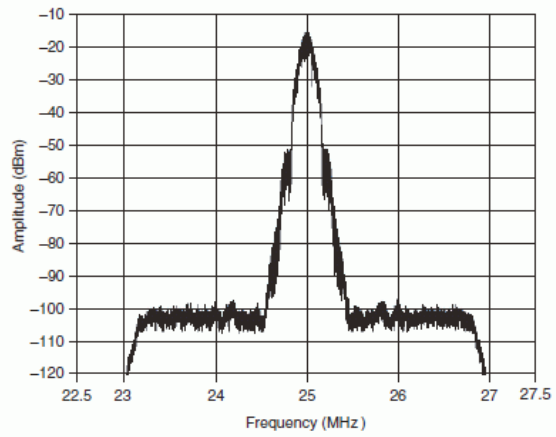

**W-CDMA Physical Layer 1, 3**

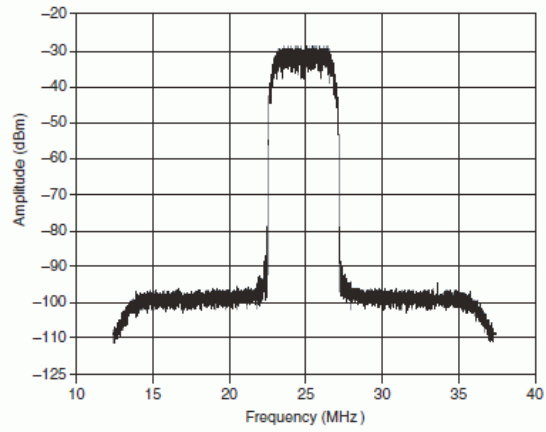

DVB Physical Layer 1,4

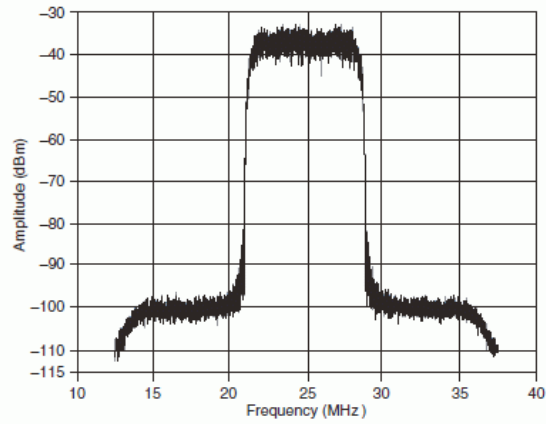

20 MSymbols/s 64 QAM 1,5

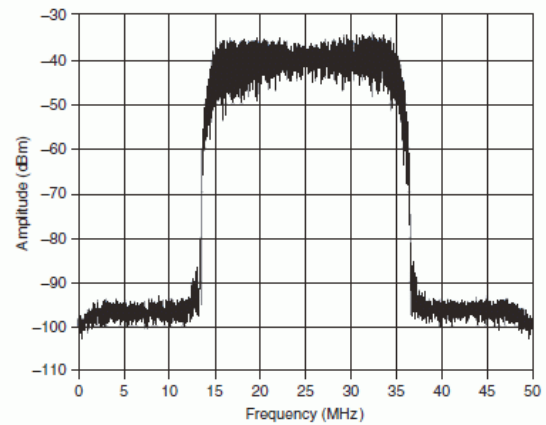

<sup>1</sup> Vertical Range = 1 V<sub>pk-pk</sub>; input impedance = 50 Ω, no analog filter, 25 MHz carrier

<sup>2</sup> Sample Rate = 4.17 MS/s, MSK modulation, 270.833 kSymbols/s, Gaussian, BT = 0.3

<sup>3</sup> Sample Rate = 25 MS/s, QPSK modulation, 3.84 MSymbols/s, root raised cosine, alpha = 0.22

<sup>4</sup> Sample Rate = 25 MS/s, 32 QAM modulation, 6.92 MSymbols/s, root raised cosine, alpha = 0.15

<sup>5</sup> Sample Rate = 50 MS/s, 64 QAM modulation, 20 MSymbols/s, root raised cosine, alpha = 0.15

## Calibration

Specification	Value
Self-Calibration	Self-calibration is done on software command. The calibration corrects for gain, offset, frequency response, triggering, and timing adjustment errors for all input ranges.
External Calibration (Factory Calibration)	The external calibration calibrates the VCXO and the voltage reference. Appropriate constants are stored in nonvolatile memory.
Interval for External Calibration	2 years
Warm-Up Time	15 minutes

## Power

Specification	Typical Value	
	NI PXI-5142	NI PCI-5142
+3.3 VDC	1.0 A	3.4 A
+5 VDC	1.7 A	2.7 A
+12 VDC	800 mA	110 mA
-12 VDC	270 mA	0 A
Total Power	24.7 W	26.1 W

## Software

Specification	Value
Driver Software	NI-SCOPE 3.0 or later.  NI-SCOPE is an IVI-compliant driver that allows you to configure, control, and calibrate the NI 5142. NI-SCOPE provides application programming interfaces for many development environments.
Application Software	NI-SCOPE provides programming interfaces, documentation, and examples for the following application development environments: <ul style="list-style-type: none"> <li>▪ LabVIEW</li> <li>▪ LabWindows™/CVI™</li> <li>▪ Measurement Studio</li> <li>▪ Microsoft Visual C/C++</li> <li>▪ Microsoft Visual Basic</li> </ul>
Interactive Soft Front Panel and Configuration	The Scope Soft Front Panel 2.4 or later supports interactive control of the NI 5142. The Scope Soft Front Panel is included on the NI-SCOPE CD.  National Instruments Measurement & Automation Explorer (MAX) also provides interactive configuration and test tools for the NI 5142. MAX is included on the NI-SCOPE CD.

## Environment

### NI PXI-5142



**Note** To ensure that the NI PXI-5142 cools effectively, follow the guidelines in the *Maintain Forced-Air Cooling Note to Users* included in the NI PXI-5142 kit. The NI PXI-5142 is intended for indoor use only.

Specification	Value	Comments
Operating Temperature	0 °C to +55 °C in all NI PXI chassis except the following:  0 °C to +45 °C when installed in an NI PXI-1000/B or PXI-101 x chassis.  Meets IEC-60068-2-1 and IEC-60068-2-2.	—
Storage Temperature	–40 °C to +71 °C. Meets IEC-60068-2-1 and IEC-60068-2-2.	—
Operating Relative Humidity	10% to 90%, noncondensing. Meets IEC-60068-2-56.	—
Storage Relative Humidity	5% to 95%, noncondensing. Meets IEC-60068-2-56.	—
Operating Shock	30 g, half-sine, 11 ms pulse. Meets IEC-60068-2-27. Test profile developed in accordance with MIL-PRF-28800F.	—
Storage Shock	50 g, half-sine, 11 ms pulse. Meets IEC-60068-2-27. Test profile developed in accordance with MIL-PRF-28800F.	—
Operating Vibration	5 Hz to 500 Hz, 0.31 g <sub>rms</sub> . Meets IEC-60068-2-64.	—
Storage Vibration	5 Hz to 500 Hz, 2.46 g <sub>rms</sub> . Meets IEC-60068-2-64. Test profile exceeds requirements of MIL-PRF-28800F, Class 3.	—
Altitude	2,000 m maximum (at 25 °C ambient temperature)	—
Pollution Degree	2	—

#### NI PCI-5142

 **Note** To ensure that the NI PCI-5142 cools effectively, make sure that the chassis in which it is used has active cooling that provides at least some airflow across the PCI card cage. To maximize airflow and extend the life of the device, leave any adjacent PCI slots empty. Refer to the *Maintain Forced-Air Cooling Note to Users* included in the NI PCI-5142 kit for important cooling information. The NI PCI-5142 is intended for indoor use only.

Specification	Value	Comments
Operating Temperature	0 °C to +45 °C. Meets IEC-60068-2-1 and IEC-60068-2-2.	—
Storage Temperature	–40 °C to +71 °C. Meets IEC-60068-2-1 and IEC-60068-2-2.	—
Operating Relative Humidity	10% to 90%, noncondensing. Meets IEC-60068-2-56.	—
Storage Relative Humidity	5% to 95%, noncondensing. Meets IEC-60068-2-56.	—
Storage Shock	50 g, half-sine, 11 ms pulse. Meets IEC-60068-2-27. Test profile developed in accordance with MIL-PRF-28800F.	—
Storage Vibration	5 Hz to 500 Hz, 2.46 g <sub>rms</sub> . Meets IEC-60068-2-64. Test profile exceeds requirements of MIL-PRF-28800F, Class 3.	—
Altitude	2,000 m maximum (at 25 °C ambient temperature)	—
Pollution Degree	2	—

## Safety, Electromagnetic Compatibility, and CE Compliance

### Safety Standards

This product is designed to meet the requirements of the following standards of safety for electrical equipment for measurement, control, and laboratory use:

- IEC 61010-1, EN 61010-1
- UL 61010-1, CSA 61010-1

 **Note** For UL and other safety certifications, refer to the product label or the *Online Product Certification* section.

### Electromagnetic Compatibility

This product meets the requirements of the following EMC standards for electrical equipment for measurement, control, and laboratory use:

- EN 61326 (IEC 61326): Class A emissions; Basic immunity
- EN 55011 (CISPR 11): Group 1, Class A emissions
- AS/NZS CISPR 11: Group 1, Class A emissions
- FCC 47 CFR Part 15B: Class A emissions
- ICES-001: Class A emissions

 **Note** For the standards applied to assess the EMC of this product, refer to the *Online Product Certification* section.

 **Note** For EMC compliance, operate this device with RG223/U or equivalent shielded cable. Operate according to product documentation.

## CE Compliance

This product meets the essential requirements of applicable European Directives, as amended for CE marking, as follows:

- 2006/95/EC; Low-Voltage Directive (safety)
- 2004/108/EC; Electromagnetic Compatibility Directive (EMC)

## Online Product Certification

Refer to the product Declaration of Conformity (DoC) for additional regulatory compliance information. To obtain product certifications and the DoC for this product, visit [ni.com/certification](http://ni.com/certification), search by module number or product line, and click the appropriate link in the Certification column.

## Environmental Management

National Instruments is committed to designing and manufacturing products in an environmentally responsible manner. NI recognizes that eliminating certain hazardous substances from our products is beneficial not only to the environment but also to NI customers.

For additional environmental information, refer to the *NI and the Environment* Web page at [ni.com/environment](http://ni.com/environment). This page contains the environmental regulations and directives with which NI complies, as well as other environmental information not included in this document.

## Waste Electrical and Electronic Equipment (WEEE)

 **EU Customers** At the end of the product life cycle, all products *must* be sent to a WEEE recycling center. For more information about WEEE recycling centers, National Instruments WEEE initiatives, and compliance with WEEE Directive 2002/96/EC on Waste Electrical and Electronic Equipment, visit [ni.com/environment/weee.htm](http://ni.com/environment/weee.htm).

## 电子信息产品污染控制管理办法（中国 RoHS）



**中国客户** National Instruments 符合中国电子信息产品中限制使用某些有害物质指令 (RoHS)。  
关于 National Instruments 中国 RoHS 合规性信息, 请登录 [ni.com/environment/rohs\\_china](http://ni.com/environment/rohs_china)。  
(For information about China RoHS compliance, go to [ni.com/environment/rohs\\_china](http://ni.com/environment/rohs_china).)

## Physical

### Front Panel Connectors

Label	Function	Connector Type
CH 0	Analog Input	BNC female
CH 1	Analog Input	BNC female
TRIG	External Trigger	BNC female
CLK IN	Sample Clock Input and Reference Clock Input	SMB jack
CLK OUT	Sample Clock Output and Reference Clock Output	SMB jack
AUX I/O	PFI 0, PFI 1	9-pin mini-circular DIN

### NI PXI-5142 Front Panel Indicators

Label	Function	For more information about front panel labels, refer to the <i>NI High-Speed Digitizers Help</i> .
ACCESS	The ACCESS LED indicates the status of the PCI bus and the interface from the NI PXI-5142 to the controller.	
ACTIVE	The ACTIVE LED indicates the status of the onboard acquisition hardware of the NI PXI-5142.	

## Dimensions and Weight

NI PXI-5142	
Dimensions	3U, One slot, PXI/cPCI Module 21.6 × 2.0 × 13.0 cm (8.5 × 0.8 × 5.1 in.)

Weight	459 g (16.2 oz)

<b>NI PCI-5142</b>	
Dimensions	35.5 × 2.0 × 11.3 cm (14.0 × 0.8 × 4.4 in.)
Weight	470 g (16.6 oz)

[Back to Top](#)

©2010 National Instruments. All rights reserved. CompactRIO, CVI, FieldPoint, LabVIEW, Measurement Studio, National Instruments, National Instruments Alliance Partner, NI, and ni.com are trademarks of National Instruments. The mark LabWindows is used under a license from Microsoft Corporation. Windows is a registered trademark of Microsoft Corporation in the United States and other countries. Other product and company names listed are trademarks or trade names of their respective companies. A National Instruments Alliance Partner is a business entity independent from National Instruments and has no agency, partnership, or joint-venture relationship with National Instruments.

[My Profile](#) | [RSS](#) | [Privacy](#) | [Legal](#) | [Contact NI](#) © 2011 National Instruments Corporation. All rights reserved.



## Artisan Technology Group is your source for quality new and certified-used/pre-owned equipment

- FAST SHIPPING AND DELIVERY
- TENS OF THOUSANDS OF IN-STOCK ITEMS
- EQUIPMENT DEMOS
- HUNDREDS OF MANUFACTURERS SUPPORTED
- LEASING/MONTHLY RENTALS
- ITAR CERTIFIED SECURE ASSET SOLUTIONS

### SERVICE CENTER REPAIRS

Experienced engineers and technicians on staff at our full-service, in-house repair center

### *InstraView*<sup>SM</sup> REMOTE INSPECTION

Remotely inspect equipment before purchasing with our interactive website at [www.instraview.com](http://www.instraview.com) ↗

### WE BUY USED EQUIPMENT

Sell your excess, underutilized, and idle used equipment. We also offer credit for buy-backs and trade-ins. [www.artisanng.com/WeBuyEquipment](http://www.artisanng.com/WeBuyEquipment) ↗

### LOOKING FOR MORE INFORMATION?

Visit us on the web at [www.artisanng.com](http://www.artisanng.com) ↗ for more information on price quotations, drivers, technical specifications, manuals, and documentation

**Contact us:** (888) 88-SOURCE | [sales@artisanng.com](mailto:sales@artisanng.com) | [www.artisanng.com](http://www.artisanng.com)