



## Artisan Technology Group is your source for quality new and certified-used/pre-owned equipment

- FAST SHIPPING AND DELIVERY
- TENS OF THOUSANDS OF IN-STOCK ITEMS
- EQUIPMENT DEMOS
- HUNDREDS OF MANUFACTURERS SUPPORTED
- LEASING/MONTHLY RENTALS
- ITAR CERTIFIED SECURE ASSET SOLUTIONS

### SERVICE CENTER REPAIRS

Experienced engineers and technicians on staff at our full-service, in-house repair center

### *InstraView*<sup>SM</sup> REMOTE INSPECTION

Remotely inspect equipment before purchasing with our interactive website at [www.instraview.com](http://www.instraview.com) ↗

### WE BUY USED EQUIPMENT

Sell your excess, underutilized, and idle used equipment. We also offer credit for buy-backs and trade-ins. [www.artisanng.com/WeBuyEquipment](http://www.artisanng.com/WeBuyEquipment) ↗

### LOOKING FOR MORE INFORMATION?

Visit us on the web at [www.artisanng.com](http://www.artisanng.com) ↗ for more information on price quotations, drivers, technical specifications, manuals, and documentation

**Contact us:** (888) 88-SOURCE | [sales@artisanng.com](mailto:sales@artisanng.com) | [www.artisanng.com](http://www.artisanng.com)

[Requirements and Compatibility](#) | [Detailed Specifications](#)

For user manuals and dimensional drawings, visit the product page resources tab on ni.com.

Last Revised: 2012-08-23 15:51:26.0

## NI PXI-2575, NI PXIe-2575 High-Density Multiplexers



- 196x1 1-wire, 98x1 2-wire multiplexers
- Up to 100 VDC, 100 VAC
- Up to 1 A switching/1 A carry
- Onboard relay counting
- 140 cycles/s

- Fully software programmable
- Deterministic operation with hardware triggers
- 32,000-step scan list
- Available in both PXI and PXI Express versions for optimal slot placement

### Overview

The NI PXI-2575 and PXIe-2575 are high-density multiplexer switch modules. With 196 one-wire channels or 98 two-wire channels, NI 2575 modules are capable of routing hundreds of signals to measurement devices or from source units. Each channel uses robust electromechanical relays and is capable of switching up to 100 VDC/100 VAC or 1 A. With a scanning speed of up to 140 cycles/s, an NI 2575 acts as an effective front end for high-channel-count automated test applications.

[Back to Top](#)

### Requirements and Compatibility

#### Driver Information

- NI-DAQmx
- NI-SWITCH

#### Software Compatibility

- ANSI C
- LabVIEW
- LabWindows/CVI
- Visual Basic

[Back to Top](#)

### Application and Technology

#### Automatic Scanning

NI 2575 modules maximize throughput in automated test applications using scanning. Scanning improves throughput by downloading a list of up to 32,000 connections to the switch and cycling through the list using an event (trigger) without any interruption from the host processor. You can most efficiently implement scanning by mating an NI 2575 with an instrument such as the NI PXI-4070 6½-digit FlexDMM, which issues a trigger after each measurement.

#### Relay Count Tracking

NI 2575 modules count relay closures on each of their relays. Relay counts are incremented each time a relay is actuated. You can programmatically retrieve the counts, which are stored on the modules, and use them for predictive maintenance to reduce unexpected system downtime.

#### Software

All National Instruments PXI switch modules are shipped with NI-SWITCH, an IVI-compliant driver that offers complete functionality for all switch modules. For additional

assistance in configuring, programming, and managing higher channel-count switching systems, NI Switch Executive software provides an easy-to-use, intelligent switch management and visual routing environment.

[Back to Top](#)

---

## Software Recommendations

### NI LabWindows™/CVI for Windows

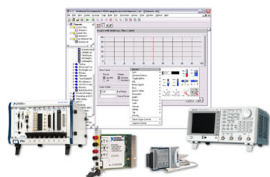

- Real-time advanced 2D graphs and charts
- Complete hardware compatibility with IVI, VISA, DAQ, GPIB, and serial
- Analysis tools for array manipulation, signal processing statistics, and curve fitting
- Simplified cross-platform communication with network variables
- Measurement Studio .NET tools (included in LabWindows/CVI Full only)
- The mark LabWindows is used under a license from Microsoft Corporation.

[Back to Top](#)

---

## Support and Services

### System Assurance Programs

NI system assurance programs are designed to make it even easier for you to own an NI system. These programs include configuration and deployment services for your NI PXI, CompactRIO, or Compact FieldPoint system. The NI Basic System Assurance Program provides a simple integration test and ensures that your system is delivered completely assembled in one box. When you configure your system with the NI Standard System Assurance Program, you can select from available NI system driver sets and application development environments to create customized, reorderable software configurations. Your system arrives fully assembled and tested in one box with your software preinstalled. When you order your system with the standard program, you also receive system-specific documentation including a bill of materials, an integration test report, a recommended maintenance plan, and frequently asked question documents. Finally, the standard program reduces the total cost of owning an NI system by providing three years of warranty coverage and calibration service. Use the online product advisors at [ni.com/advisor](http://ni.com/advisor) to find a system assurance program to meet your needs.

### Calibration

NI measurement hardware is calibrated to ensure measurement accuracy and verify that the device meets its published specifications. To ensure the ongoing accuracy of your measurement hardware, NI offers basic or detailed recalibration service that provides ongoing ISO 9001 audit compliance and confidence in your measurements. To learn more about NI calibration services or to locate a qualified service center near you, contact your local sales office or visit [ni.com/calibration](http://ni.com/calibration).

### Technical Support

Get answers to your technical questions using the following National Instruments resources.

- **Support** - Visit [ni.com/support](http://ni.com/support) to access the NI KnowledgeBase, example programs, and tutorials or to contact our applications engineers who are located in NI sales offices around the world and speak the local language.
- **Discussion Forums** - Visit [forums.ni.com](http://forums.ni.com) for a diverse set of discussion boards on topics you care about.
- **Online Community** - Visit [community.ni.com](http://community.ni.com) to find, contribute, or collaborate on customer-contributed technical content with users like you.

### Repair

While you may never need your hardware repaired, NI understands that unexpected events may lead to necessary repairs. NI offers repair services performed by highly trained technicians who quickly return your device with the guarantee that it will perform to factory specifications. For more information, visit [ni.com/repair](http://ni.com/repair).

### Training and Certifications

The NI training and certification program delivers the fastest, most certain route to increased proficiency and productivity using NI software and hardware. Training builds the skills to more efficiently develop robust, maintainable applications, while certification validates your knowledge and ability.

- **Classroom training in cities worldwide** - the most comprehensive hands-on training taught by engineers.
- **On-site training at your facility** - an excellent option to train multiple employees at the same time.
- **Online instructor-led training** - lower-cost, remote training if classroom or on-site courses are not possible.
- **Course kits** - lowest-cost, self-paced training that you can use as reference guides.
- **Training memberships** and training credits - to buy now and schedule training later.

Visit [ni.com/training](http://ni.com/training) for more information.

### Extended Warranty

NI offers options for extending the standard product warranty to meet the life-cycle requirements of your project. In addition, because NI understands that your requirements may change, the extended warranty is flexible in length and easily renewed. For more information, visit [ni.com/warranty](http://ni.com/warranty).

### OEM

NI offers design-in consulting and product integration assistance if you need NI products for OEM applications. For information about special pricing and services for OEM customers, visit [ni.com/oem](http://ni.com/oem).

### Alliance

## Detailed Specifications

### 196 × 1 Relay Multiplexer

This document lists specifications for the NI PXI/PXIe-2575 (NI 2575) 196 × 1 multiplexer relay module. All specifications are subject to change without notice. Visit [ni.com/manuals](http://ni.com/manuals) for the most current specifications.

Topologies	1-wire 196 × 1 multiplexer, 2-wire 95 × 1 multiplexer, 2-wire 98 × 1 multiplexer
------------	--

Refer to the *NI Switches Help* for detailed topology and pinout information.

### Input Characteristics

All input characteristics are DC,  $AC_{rms}$ , or a combination unless otherwise specified.

#### Maximum switching voltage

Channel-to-channel	100 V
Channel-to-ground	100 V, CAT I

 **Caution** This module is rated for Measurement Category I and is intended to carry signal voltages no greater than 100 V. This module can withstand up to 500 V impulse voltage. Do not use this module for connection to signals or for measurements within Categories II, III, or IV. Do not connect to MAINs supply circuits (for example, wall outlets) of 115 or 230 VAC. Refer to the *Read Me First: Safety and Electromagnetic Compatibility* document for more information about measurement categories.

 **Caution** When hazardous voltages ( $>42.4 V_{pk}/60 VDC$ ) are present on any relay terminal, safety low-voltage ( $\leq 42.4 V_{pk}/60 VDC$ ) cannot be connected to any other relay terminal.

 **Caution** The maximum switching power is limited by the maximum switching current and the maximum voltage, and must not exceed 30 W, 37.5 VA.

Maximum switching power (per channel)	60 W, 62.5 VA (DC to 60 Hz)
DC isolation resistance (between channel and COM terminals)	$>1 G\Omega$ , typical at 25 °C
Maximum total current (switching or carry)	1 A
Minimum switch load	20 mV/1 mA

 **Note** The maximum switch load is not recommended for 2-wire resistance measurements.

 **Note** Switching inductive loads (for example, motors and solenoids) can produce high voltage transients in excess of the module's rated voltage. Without additional protection, these transients can interfere with module operation and impact relay life. For more information about transient suppression, visit [ni.com/info](http://ni.com/info) and enter the Info Code *induct*.

#### DC path resistance

Initial	$<0.5 \Omega$
End-of-life	$\geq 1 \Omega$

DC path resistance typically remains low for the life of the relay. At the end of relay life, the path resistance rapidly rises above 1  $\Omega$ . Load ratings apply to relays used within the specification before the end of relay life.

#### Differential thermal EMF

Typical <sup>1</sup>	3 $\mu V$
Maximum	$<12 \mu V$

#### Bandwidth (–3 dB, 50 $\Omega$ termination)

1-wire	$>20 MHz$
2-wire	$>8 MHz$

#### Channel-to-channel isolation (50 $\Omega$ termination)

Each relay in the NI 2575 is shared by two channels. Refer to the *NI 2575 Channel Pairs* table for a list of channel pairings.

1-wire channels in different relays	
10 kHz	$>90 dB$
100 kHz	$>70 dB$

1 MHz	>50 dB
1-wire channels in the same relay	
10 kHz	>75 dB
100 kHz	>55 dB
1 MHz	>35 dB
2-wire channels	
10 kHz	>95 dB
100 kHz	>75 dB
1 MHz	>55 dB
Open channel isolation (50 $\Omega$ termination)	
10 kHz	>85 dB
100 kHz	>65 dB
1 MHz	>48 dB

### Dynamic Characteristics

#### Relay operate time

Typical	1 ms
Maximum	3.4 ms

 **Note** Certain applications may require additional time for proper settling. Refer to the *NI Switches Help* for information about including additional settling time.

Maximum scan rate	120 channels/s
-------------------	----------------

#### Expected relay life

Mechanical	$5 \times 10^7$ cycles
Electrical	
10 VDC, 100 mADC resistive	$1 \times 10^6$ cycles
10 VDC, 1 ADC resistive	$5 \times 10^5$ cycles
30 VDC, 1 ADC resistive	$1 \times 10^5$ cycles

 **Note** The relays used in the NI 2575 are field replaceable. Refer to the *NI Switches Help* for information about replacing a failed relay.

### Trigger Characteristics

#### Input trigger

Sources	PXI trigger lines 0–7
Minimum pulse width	150 ns

 **Note** The NI 2575 can recognize trigger pulse widths less than 150 ns by disabling digital filtering. For information about disabling digital filtering, refer to the *NI Switches Help*.

#### Output trigger

Destinations	PXI trigger lines 0–7
Pulse width	Programmable (1 $\mu$ s to 62 $\mu$ s)

### Physical Characteristics

Relay type	Electromechanical, latching
Relay contact material	Silver, gold covered
I/O connector	200 POS LFH Matrix 50, receptacle
Power requirement	

PXI	6 W at 5 V, 2.5 W at 3.3 V
PXI Express	7.5 W at 12V, 2.5 W at 3.3 V
Dimensions (L × W × H)	3U, one slot, PXI/cPCI module, PXIe compatible 21.6 × 2.0 × 13.0 cm (8.5 × 0.8 × 5.1 in.)
Weight	289 g (10.2 oz)

### Environment

Operating temperature	0 °C to 55 °C
Storage temperature	−20 °C to 70 °C
Relative humidity	5% to 85%, noncondensing
Pollution Degree	2
Maximum altitude	2,000 m
Indoor use only.	

### Shock and Vibration

Operational Shock	30 g peak, half-sine, 11 ms pulse (Tested in accordance with IEC 60068-2-27. Test profile developed in accordance with MIL-PRF-28800F.)
Random Vibration	
Operating	5 to 500 Hz, 0.3 g <sub>rms</sub>
Nonoperating	5 to 500 Hz, 2.4 g <sub>rms</sub> (Tested in accordance with IEC 60068-2-64. Nonoperating test profile exceeds the requirements of MIL-PRF-28800F, Class 3.)

### Accessories

Visit [ni.com](http://ni.com) for more information about the following accessories.

NI Accessories for the NI 2575	
Accessory	Part Number
LFH200 Connector to Bare Wire Switch Cable, 2 m	779038-01
LFH200 to 50-Pin D-SUB Switch Cable (CH-CH Twisted), 1 m	779038-03
NI TBX-50, 50-pin DSUB screw terminal block	779305-01
Relay replacement kit for G6KU-2F-Y relays	780386-01



**Note** When using either of the LFH200 cables in the previous table with the NI 2575 in the 2-wire 98 × 1 topology, CH95, CH96, and CH97 will have lower RF performance than the other 95 channels because they are not in twisted pairs in the cable. To avoid using these channels, NI-SWITCH has support for a 2-wire 95 × 1 topology that does not include CH95, CH96, and CH97.

Third-Party Accessories for the NI 2575		
Accessory	Manufacturer	Part Number
Terminal sticks (four required per module)	Molex	71715-4002
Plug connector subassembly	Molex	71719-3000
Backshell only	Jevons	JDC200B-832
DAK assembly for SCOUT Mass Interconnect, 200-pin LFH, male	MAC Panel	561036
Mass interconnect cable assembly, 20 in.	Virginia Panel	540105010105
Mass interconnect cable assembly, 36 in.	Virginia Panel	540105010205
Mating ITA module* (one required per module)	Virginia Panel	510108131
Mating ITA PC* (198 required per module)	Virginia Panel	720101101
*Additional cover or enclosure required. See the previous safety caution.		



**Caution** You *must* install mating connectors according to local safety codes and standards and according to the specifications provided by the connector manufacturer. You are responsible for verifying safety compliance of third-party connectors and their usage according to the relevant standard(s), including UL and CSA in North America and IEC and VDE in Europe.

Third-Party Accessories for the SH200LFH-4xDB50F-S Cable		
Accessory	Manufacturer	Part Number

Third-Party Accessories for the SH200LFH-4xDB50F-S Cable		
Accessory	Manufacturer	Part Number
VARIOFACE module, with screw connection and 50 position D-Subminiature pin strip	Phoenix Contact	FLK-D50 SUB/S
VARIOFACE module, with screw connection and 50 position D-Subminiature pin strip	Phoenix Contact	FLKM-D50 SUB/S
VARIOFACE module, with screw connection and 50 position D-Subminiature pin strip	Phoenix Contact	FLKMS-D50 SUB/S
VARIOFACE module, with screw connection and 50 position D-Subminiature pin strip, with LED indicators	Phoenix Contact	FLKM-D50 SUB/S/LA

NI 2575 Channel Pairs		
Channel Pair	Channel Pair	Channel Pair
CH0, CH95	CH33, CH128	CH66, CH161
CH1, CH96	CH34, CH129	CH67, CH162
CH2, CH97	CH35, CH130	CH68, CH163
CH3, CH98	CH36, CH131	CH69, CH164
CH4, CH99	CH37, CH132	CH70, CH165
CH5, CH100	CH38, CH133	CH71, CH166
CH6, CH101	CH39, CH134	CH72, CH167
CH7, CH102	CH40, CH135	CH73, CH168
CH8, CH103	CH41, CH136	CH74, CH169
CH9, CH104	CH42, CH137	CH75, CH170
CH10, CH105	CH43, CH138	CH76, CH171
CH11, CH106	CH44, CH139	CH77, CH172
CH12, CH107	CH45, CH140	CH78, CH173
CH13, CH108	CH46, CH141	CH79, CH174
CH14, CH109	CH47, CH142	CH80, CH175
CH15, CH110	CH48, CH143	CH81, CH176
CH16, CH111	CH49, CH144	CH82, CH177
CH17, CH112	CH50, CH145	CH83, CH178
CH18, CH113	CH51, CH146	CH84, CH179
CH19, CH114	CH52, CH147	CH85, CH180
CH20, CH115	CH53, CH148	CH86, CH181
CH21, CH116	CH54, CH149	CH87, CH182
CH22, CH117	CH55, CH150	CH88, CH183
CH23, CH118	CH56, CH151	CH89, CH184
CH24, CH119	CH57, CH152	CH90, CH185
CH25, CH120	CH58, CH153	CH91, CH186
CH26, CH121	CH59, CH154	CH92, CH187
CH27, CH122	CH60, CH155	CH93, CH188
CH28, CH123	CH61, CH156	CH94, CH189
CH29, CH124	CH62, CH157	CH190, CH193
CH30, CH125	CH63, CH158	CH191, CH194
CH31, CH126	CH64, CH159	CH192, CH195
CH32, CH127	CH65, CH160	—

The following figure shows the NI 2575 power-on state.

**NI 2575 Power-On State**

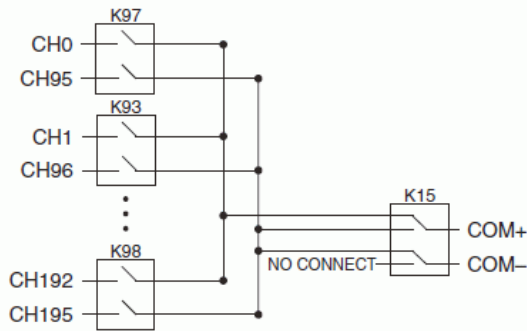

## Compliance and Certifications

### Safety Standards

This product is designed to meet the requirements of the following standards of safety for electrical equipment for measurement, control, and laboratory use:

- IEC 61010-1, EN 61010-1
- UL 61010-1, CSA 61010-1

 **Note** For UL and other safety certifications, refer to the product label or the *Online Product Certification* section.

### Electromagnetic Compatibility

This product meets the requirements of the following EMC standards for electrical equipment for measurement, control, and laboratory use:

- EN 61326 (IEC 61326): Class A emissions; Basic immunity
- EN 55011 (CISPR 11): Group 1, Class A emissions
- AS/NZS CISPR 11: Group 1, Class A emissions
- FCC 47 CFR Part 15B: Class A emissions
- ICES-001: Class A emissions

 **Note** For the standards applied to assess the EMC of this product, refer to the *Online Product Certification* section.

 **Note** For EMC compliance, operate this device with shielded cables.

### CE Compliance

This product meets the essential requirements of applicable European Directives, as amended for CE marking, as follows:

- 2006/95/EC; Low-Voltage Directive (safety)
- 2004/108/EC; Electromagnetic Compatibility Directive (EMC)

### Online Product Certification

To obtain product certifications and the DoC for this product, visit [ni.com/certification](http://ni.com/certification), search by model number or product line, and click the appropriate link in the Certification column.

## Environmental Management

NI is committed to designing and manufacturing products in an environmentally responsible manner. NI recognizes that eliminating certain hazardous substances from our products is beneficial not only to the environment but also to NI customers.

For additional environmental information, refer to the *NI and the Environment* Web page at [ni.com/environment](http://ni.com/environment). This page contains the environmental regulations and directives with which NI complies, as well as other environmental information not included in this document.

### Waste Electrical and Electronic Equipment (WEEE)

 **EU Customers** At the end of the product life cycle, all products *must* be sent to a WEEE recycling center. For more information about WEEE recycling centers, National Instruments WEEE initiatives, and compliance with WEEE Directive 2002/96/EC on Waste Electrical and Electronic Equipment, visit [ni.com/environment/weee.htm](http://ni.com/environment/weee.htm).

### 电子信息产品污染控制管理办法（中国 RoHS）



**中国客户** National Instruments 符合中国电子信息产品中限制使用某些有害物质指令 (RoHS)。  
关于 National Instruments 中国 RoHS 合规性信息, 请登录 [ni.com/environment/rohs\\_china](http://ni.com/environment/rohs_china)。  
(For information about China RoHS compliance, go to [ni.com/environment/rohs\\_china](http://ni.com/environment/rohs_china).)

<sup>1</sup> To ensure the typical thermal EMF, power down all relays and avoid pulsing high currents near the channels you are measuring. For more information about powering down latching relays, refer to the *Power Down Latching Relays After Debounce* property in NI-SWITCH or the *Power Down Latching Relays After Settling* property in NI-DAQmx.

[Back to Top](#)







## Artisan Technology Group is your source for quality new and certified-used/pre-owned equipment

- FAST SHIPPING AND DELIVERY
- TENS OF THOUSANDS OF IN-STOCK ITEMS
- EQUIPMENT DEMOS
- HUNDREDS OF MANUFACTURERS SUPPORTED
- LEASING/MONTHLY RENTALS
- ITAR CERTIFIED SECURE ASSET SOLUTIONS

### SERVICE CENTER REPAIRS

Experienced engineers and technicians on staff at our full-service, in-house repair center

### *InstraView*<sup>SM</sup> REMOTE INSPECTION

Remotely inspect equipment before purchasing with our interactive website at [www.instraview.com](http://www.instraview.com) ↗

### WE BUY USED EQUIPMENT

Sell your excess, underutilized, and idle used equipment. We also offer credit for buy-backs and trade-ins. [www.artisanng.com/WeBuyEquipment](http://www.artisanng.com/WeBuyEquipment) ↗

### LOOKING FOR MORE INFORMATION?

Visit us on the web at [www.artisanng.com](http://www.artisanng.com) ↗ for more information on price quotations, drivers, technical specifications, manuals, and documentation

**Contact us:** (888) 88-SOURCE | [sales@artisanng.com](mailto:sales@artisanng.com) | [www.artisanng.com](http://www.artisanng.com)