

# VXIpc™ -850 Series User Manual

April 1996 Edition  
Part Number 321124A-01

© Copyright 1996 National Instruments Corporation.  
All Rights Reserved.

---



### Internet Support

GPIB: [gpiib.support@natinst.com](mailto:gpiib.support@natinst.com)  
DAQ: [daq.support@natinst.com](mailto:daq.support@natinst.com)  
VXI: [vxi.support@natinst.com](mailto:vxi.support@natinst.com)  
LabVIEW: [lv.support@natinst.com](mailto:lv.support@natinst.com)  
LabWindows: [lw.support@natinst.com](mailto:lw.support@natinst.com)  
HiQ: [hiq.support@natinst.com](mailto:hiq.support@natinst.com)  
VISA: [visa.support@natinst.com](mailto:visa.support@natinst.com)

E-mail: [info@natinst.com](mailto:info@natinst.com)  
FTP Site: [ftp.natinst.com](ftp://ftp.natinst.com)  
Web Address: [www.natinst.com](http://www.natinst.com)



### Bulletin Board Support

BBS United States: (512) 794-5422 or (800) 327-3077  
BBS United Kingdom: 01635 551422  
BBS France: 1 48 65 15 59



### FaxBack Support

(512) 418-1111



### Telephone Support (U.S.)

Tel: (512) 795-8248  
Fax: (512) 794-5678



### International Offices

Australia 03 9 879 9422, Austria 0662 45 79 90 0, Belgium 02 757 00 20, Canada (Ontario) 519 622 9310, Canada (Québec) 514 694 8521, Denmark 45 76 26 00, Finland 90 527 2321, France 1 48 14 24 24, Germany 089 741 31 30, Hong Kong 2645 3186, Italy 02 413091, Japan 03 5472 2970, Korea 02 596 7456, Mexico 95 800 010 0793, Netherlands 0348 433466, Norway 32 84 84 00, Singapore 2265886, Spain 91 640 0085, Sweden 08 730 49 70, Switzerland 056 200 51 51, Taiwan 02 377 1200, U.K. 01635 523545

### National Instruments Corporate Headquarters

6504 Bridge Point Parkway      Austin, TX 78730-5039      Tel: (512) 794-0100

# Important Information

---

## Warranty

The National Instruments VXIpc-850 Series embedded computers and accessories are warranted against defects in materials and workmanship for a period of one year from the date of shipment, as evidenced by receipts or other documentation. National Instruments will, at its option, repair or replace equipment that proves to be defective during the warranty period. This warranty includes parts and labor.

The media on which you receive National Instruments software are warranted not to fail to execute programming instructions, due to defects in materials and workmanship, for a period of 90 days from date of shipment, as evidenced by receipts or other documentation. National Instruments will, at its option, repair or replace software media that do not execute programming instructions if National Instruments receives notice of such defects during the warranty period. National Instruments does not warrant that the operation of the software shall be uninterrupted or error free.

A Return Material Authorization (RMA) number must be obtained from the factory and clearly marked on the outside of the package before any equipment will be accepted for warranty work. National Instruments will pay the shipping costs of returning to the owner parts which are covered by warranty.

National Instruments believes that the information in this manual is accurate. The document has been carefully reviewed for technical accuracy. In the event that technical or typographical errors exist, National Instruments reserves the right to make changes to subsequent editions of this document without prior notice to holders of this edition. The reader should consult National Instruments if errors are suspected. In no event shall National Instruments be liable for any damages arising out of or related to this document or the information contained in it.

EXCEPT AS SPECIFIED HEREIN, NATIONAL INSTRUMENTS MAKES NO WARRANTIES, EXPRESS OR IMPLIED, AND SPECIFICALLY DISCLAIMS ANY WARRANTY OF MERCHANTABILITY OR FITNESS FOR A PARTICULAR PURPOSE. CUSTOMER'S RIGHT TO RECOVER DAMAGES CAUSED BY FAULT OR NEGLIGENCE ON THE PART OF NATIONAL INSTRUMENTS SHALL BE LIMITED TO THE AMOUNT THEREFORE PAID BY THE CUSTOMER. NATIONAL INSTRUMENTS WILL NOT BE LIABLE FOR DAMAGES RESULTING FROM LOSS OF DATA, PROFITS, USE OF PRODUCTS, OR INCIDENTAL OR CONSEQUENTIAL DAMAGES, EVEN IF ADVISED OF THE POSSIBILITY THEREOF. This limitation of the liability of National Instruments will apply regardless of the form of action, whether in contract or tort, including negligence. Any action against National Instruments must be brought within one year after the cause of action accrues. National Instruments shall not be liable for any delay in performance due to causes beyond its reasonable control. The warranty provided herein does not cover damages, defects, malfunctions, or service failures caused by owner's failure to follow the National Instruments installation, operation, or maintenance instructions; owner's modification of the product; owner's abuse, misuse, or negligent acts; and power failure or surges, fire, flood, accident, actions of third parties, or other events outside reasonable control.

## Copyright

Under the copyright laws, this publication may not be reproduced or transmitted in any form, electronic or mechanical, including photocopying, recording, storing in an information retrieval system, or translating, in whole or in part, without the prior written consent of National Instruments Corporation.

## Trademarks

LabVIEW®, MANTIS™, MITE™, NI-488.2™, NI-VISA™, NI-VXI™, TIC™, TNT™, and VXIpc™ are trademarks of National Instruments Corporation.

Product and company names listed are trademarks or trade names of their respective companies.

## WARNING REGARDING MEDICAL AND CLINICAL USE OF NATIONAL INSTRUMENTS PRODUCTS

National Instruments products are not designed with components and testing intended to ensure a level of reliability suitable for use in treatment and diagnosis of humans. Applications of National Instruments products involving medical or clinical treatment can create a potential for accidental injury caused by product failure, or by errors on the part of the user or application designer. Any use or application of National Instruments products for or involving medical or clinical treatment must be performed by properly trained and qualified medical personnel, and all traditional medical safeguards, equipment, and procedures that are appropriate in the particular situation to prevent serious injury or death should always continue to be used when National Instruments products are being used. National Instruments products are NOT intended to be a substitute for any form of established process, procedure, or equipment used to monitor or safeguard human health and safety in medical or clinical treatment.

# FCC/DOC Radio Frequency Interference Class A Compliance

---

This equipment generates and uses radio frequency energy and, if not installed and used in strict accordance with the instructions in this manual, may cause interference to radio and television reception. Classification requirements are the same for the Federal Communications Commission (FCC) and the Canadian Department of Communications (DOC). This equipment has been tested and found to comply with the following two regulatory agencies:

## Federal Communications Commission

This equipment has been tested and found to comply with the limits for a Class A digital device, pursuant to part 15 of the FCC Rules. These limits are designed to provide reasonable protection against harmful interference when the equipment is operated in a commercial environment. This equipment generates, uses, and can radiate radio frequency energy and, if not installed and used in accordance with the instruction manual, may cause harmful interference to radio communications. Operation of this equipment in a residential area is likely to cause harmful interference in which case the user will be required to correct the interference at his own expense.

**Notices to User:** *Changes or modifications not expressly approved by National Instruments could void the user's authority to operate the equipment under the FCC Rules.*

*This device complies with the FCC rules only if used with shielded interface cables of suitable quality and construction. National Instruments used such cables to test this device and provides them for sale to the user. The use of inferior or nonshielded interface cables could void the user's authority to operate the equipment under the FCC rules.*

If necessary, consult National Instruments or an experienced radio/television technician for additional suggestions. The following booklet prepared by the FCC may also be helpful: *Interference to Home Electronic Entertainment Equipment Handbook*. This booklet is available from the U.S. Government Printing Office, Washington, DC 20402.

## Canadian Department of Communications

This Class A digital apparatus meets all requirements of the Canadian Interference-Causing Equipment Regulations.

Cet appareil numérique de la classe A respecte toutes les exigences du Règlement sur le matériel brouilleur du Canada.

***Table  
of  
Contents***

---

## About This Manual

Organization of This Manual .....	xi
Conventions Used in This Manual.....	xii
How to Use This Documentation Set.....	xiii
Related Documentation .....	xiv
Customer Communication .....	xiv

## Chapter 1

### Introduction

Optional Equipment .....	1-2
Optional Software .....	1-2
Hardware Description .....	1-3
Slot 0 Functionality .....	1-4
Custom Application-Specific Interface Chips .....	1-4
Front Panel Features .....	1-5
Peripheral Expansion .....	1-6

## Chapter 2

### Functional Overview

VXIpc-850 Functional Description .....	2-1
----------------------------------------	-----

## Chapter 3

### Configuration and Installation

Default Settings .....	3-1
Configuring the VXIpc-850.....	3-4
How to Remove the Metal Enclosure .....	3-4
VXIbus Slot 0/Non-Slot 0 .....	3-4
VXIbus CLK10 Routing .....	3-5
Trigger Input Termination.....	3-7
EEPROM.....	3-8
How to Fix an Invalid EEPROM Configuration.....	3-9
Installed System RAM .....	3-9

Configuring the PC .....	3-9
SCSI Termination .....	3-10
GPIB Interrupt Level .....	3-10
System CMOS .....	3-10
Parallel Port DMA Level .....	3-11
Ethernet Power-On Defaults .....	3-11
Installing the VXIpc-850 .....	3-12

## Chapter 4 WinBIOS

Entering WinBIOS Setup .....	4-1
Using a Mouse with WinBIOS Setup .....	4-1
Using the Keyboard with WinBIOS Setup .....	4-2
WinBIOS Main Menu .....	4-3

## Chapter 5 Peripherals

Software Installation .....	5-2
Why National Instruments Does Not Install All Peripheral Drivers .....	5-2
Installing Peripheral Drivers .....	5-2
Video .....	5-3
About the Trident Video Manual .....	5-3
Technical Information about the Video Interface .....	5-3
IDE .....	5-4
Installing the IDE Software .....	5-4
Technical Information about the IDE Interface .....	5-5
Ethernet .....	5-6
Configuring Your Ethernet Addresses .....	5-6
Installing the Ethernet Software .....	5-6
Technical Information about the Ethernet Interface .....	5-7
Support .....	5-7
PCMCIA .....	5-8
Installing the PCMCIA Software .....	5-8
Technical Information about the PCMCIA Interface .....	5-9
SCSI .....	5-9
Installing the SCSI Software .....	5-9
Technical Information about the SCSI Interface .....	5-9
GPIB (IEEE-488.2) .....	5-10
Base Address, DMA, and IRQ Configuration .....	5-10
Installing the NI-488.2 Software .....	5-10

## Appendix A Specifications

Electrical .....	A-1
Physical .....	A-1
Environmental .....	A-2
Requirements .....	A-2
Performance .....	A-2
VMEbus Capability Codes .....	A-3
Adding RAM.....	A-3

## Appendix B VXIpc-850 System Resources

PCI Interrupts .....	B-1
Resource Tables .....	B-1

## Appendix C LED Indicators

VXIbus Interface Status LEDs.....	C-1
SYSFAIL LED .....	C-1
FAILED LED .....	C-1
ONLINE LED.....	C-1
TEST LED .....	C-1
LEDs and System Startup Cycle.....	C-2
Board Access LEDs .....	C-3
ACCESS LED .....	C-3
DRIVE LED .....	C-3
Ethernet LEDs.....	C-3
RX LED .....	C-3
TX LED .....	C-3
LINK LED .....	C-3
DSEL LED .....	C-3

## Appendix D Front Panel and Connectors

Front Panel .....	D-1
Keyboard and Mouse .....	D-2
VGA .....	D-3
Ethernet .....	D-5
COM1 and COM2.....	D-6
Parallel Port .....	D-7
SCSI .....	D-8

GPIB (IEEE-488.2).....	D-10
External SMBs .....	D-11
VXIbus P1 and P2.....	D-12
Speaker.....	D-14
Signal Characteristics.....	D-15

## Appendix E

### Modifying and Installing I/O Expansion Boards

Height of VXIpc-850 Plug-In Boards .....	E-1
Length of VXIpc-850 Plug-In Boards .....	E-2
Length of PCI Plug-In Boards .....	E-2
Length of ISA Plug-In Boards .....	E-3
Installing an I/O Board.....	E-4
Materials Needed .....	E-4
Installation Steps.....	E-4

## Appendix F

### Common Questions

## Appendix G

### Customer Communication

## Glossary

## Index



## Figures

Figure 1-1.	VXIpc-850 Embedded Computer .....	1-1
Figure 2-1.	VXIpc-850 Block Diagram.....	2-2
Figure 3-1.	VXIpc-850 Parts Locator Diagram.....	3-2
Figure 3-2.	VXIbus Slot Configuration .....	3-5
Figure 3-3.	VXIbus CLK10 Routing .....	3-6
Figure 3-4.	SMB CLK10 Direction .....	3-6
Figure 3-5.	SMB CLK10 Termination .....	3-7
Figure 3-6.	SMB CLK10 Polarity .....	3-7
Figure 3-7.	SMB Trigger Input Termination.....	3-7
Figure 3-8.	Power-On Self Configuration Status .....	3-8
Figure 3-9.	SMB Trigger Input Termination.....	3-8
Figure 3-10.	SCSI Termination.....	3-10
Figure 3-11.	GPIO Interrupt Level .....	3-10
Figure 3-12.	System CMOS .....	3-11
Figure 3-13.	Parallel Port DMA Channel .....	3-11
Figure 3-14.	Ethernet Power-On Defaults .....	3-11
Figure D-1.	VXIpc-850 Front Panel Layout and Dimensions .....	D-2
Figure D-2.	Keyboard and Mouse Connectors Location and Pinout .....	D-3
Figure D-3.	VGA Connector Location and Pinout.....	D-4
Figure D-4.	Ethernet Connector Location and Pinout .....	D-5
Figure D-5.	COM1 and COM2 Connectors Location and Pinout .....	D-6
Figure D-6.	Parallel Port Connector Location and Pinout .....	D-7
Figure D-7.	SCSI Connector Location and Pinout (SCSI II).....	D-9
Figure D-8.	GPIO Connector Location and Pinout .....	D-10
Figure D-9.	SMB Connectors Location and Pinout .....	D-12
Figure D-10.	VXIbus Connectors Location and Pinout .....	D-12
Figure D-11.	Speaker Connector Location.....	D-14
Figure E-1.	I/O Board Dimensions for VXIpc-850 Expansion Slot.....	E-1
Figure E-2.	Component Height Restrictions on PCI Plug-In Boards .....	E-2
Figure E-3.	Length Restrictions on ISA Plug-In Boards .....	E-3
Figure E-4.	PCI Board Installed in a VXIpc-850 .....	E-5

## Tables

Table 3-1.	VXIpc-850 Hardware Default Settings .....	3-3
Table 4-1.	WinBIOS Options.....	4-2
Table 4-2.	WinBIOS Main Menu Windows .....	4-3
Table 5-1.	VXIpc-850 Peripheral Components .....	5-1
Table 5-2.	SMC 91C92 Default Settings .....	5-6
Table B-1.	ISA Interrupt Resource Allocations .....	B-1
Table B-2.	DMA Channel Resource Allocations .....	B-2
Table B-3.	I/O Address Map.....	B-3
Table C-1.	LEDs and System Startup Status .....	C-2
Table D-1.	Keyboard and Mouse Connector Signals .....	D-3
Table D-2.	VGA Connector Signals .....	D-4
Table D-3.	Ethernet Connector Signals .....	D-5
Table D-4.	COM1 and COM2 Connector Signals.....	D-6
Table D-5.	Parallel Port Connector Signals .....	D-8
Table D-6.	SCSI Connector Signals .....	D-9
Table D-7.	GPIB Connector Signals.....	D-11
Table D-8.	SMB Connector Signals .....	D-12
Table D-9.	VXIbus P2 Connector Signals .....	D-13
Table D-10.	VXIbus P1 Connector Signals .....	D-13
Table D-11.	Signal Characteristics for SMB and Speaker Connections.....	D-14



*About  
This  
Manual*

---

This manual contains instructions for installing and configuring the National Instruments VXIpc-850 Series embedded computer kit.

## Organization of This Manual

---

This manual is organized as follows:

- Chapter 1, *Introduction*, describes the VXIpc-850 Series of embedded VXI computers, lists what you need to get started, describes the hardware, and lists optional equipment and software.
- Chapter 2, *Functional Overview*, contains functional descriptions of each major logic block on the VXIpc-850 Series embedded computer.
- Chapter 3, *Configuration and Installation*, contains the instructions to configure and install the VXIpc-850 Series embedded computer.
- Chapter 4, *WinBIOS*, contains information on WinBIOS, the low-level interface between the hardware and PC software that configures and tests your hardware at boot up.
- Chapter 5, *Peripherals*, contains brief descriptions of each of the peripheral components of the VXIpc-850 Series embedded computer.
- Appendix A, *Specifications*, describes the environmental, electrical, and mechanical specifications of the VXIpc-850.
- Appendix B, *VXIpc-850 System Resources*, describes what system resources are available on the VXIpc-850 and where they are allocated.

- Appendix C, *LED Indicators*, describes how to read the LEDs on the front panel to interpret the status of the VXIpc-850.
- Appendix D, *Front Panel and Connectors*, describes the front panel and connectors on the VXIpc-850.
- Appendix E, *Modifying and Installing I/O Expansion Boards*, explains how to modify and install an I/O board in the VXIpc-850.
- Appendix F, *Common Questions*, answers common questions you may have when using the VXIpc-850.
- Appendix G, *Customer Communication*, contains forms you can use to request help from National Instruments or to comment on our products and manuals.
- The *Glossary* contains an alphabetical list and description of terms used in this manual, including abbreviations, acronyms, metric prefixes, mnemonics, and symbols.
- The *Index* contains an alphabetical list of key terms and topics used in this manual, including the page where you can find each one.

## Conventions Used in This Manual

---

The following conventions are used in this manual:

<b>bold</b>	Bold text denotes menus, menu items, or dialog box buttons or options.
<b><i>bold italic</i></b>	Bold italic text denotes a note, caution, or warning.
<b>bold monospace</b>	Bold text in this font denotes the messages and responses that the computer automatically prints to the screen.
<i>italic</i>	Italic text denotes emphasis, a cross reference, or an introduction to a key concept.
monospace	Text in this font denotes text or characters that are to be literally input from the keyboard, sections of code, programming examples, and syntax examples. This font is also used for the proper names of disk drives, paths, directories, programs, subprograms, subroutines, device names, functions, variables, filenames, and extensions, and for statements and comments taken from program code.

- <> Angle brackets enclose the name of a key on the keyboard—for example, <PageDown>.
- A hyphen between two or more key names enclosed in angle brackets denotes that you should simultaneously press the named keys—for example, <Control-Alt-Delete>.

Abbreviations, acronyms, metric prefixes, mnemonics, symbols, and terms are listed in the *Glossary*.

## How to Use This Documentation Set

---

Begin by reading the *Getting Started with Your VXIpc-850* manual for basic instructions on setting up the hardware and software. This is a brief *Quick Start* manual that demonstrates how to get started with your kit using the default hardware and software settings. Refer to the following manuals for more information about the hardware or software.

This manual, the *VXIpc-850 Series User Manual*, contains more details about changing the installation or configuration from the defaults, and using the hardware.

The *VXIpc-850 Peripherals User Manual* contains in-depth information about configuring and using various peripherals on the VXIpc-850.

The *NI-VXI Software Manual for the VXIpc-850 Series* contains more details about changing the NI-VXI software installation or configuration from the defaults, and using the NI-VXI software on the VXIpc-850.

When you are familiar with the material in these manuals, you can begin to use the *NI-VXI Software Reference Manual for C*. Chapter 1, *Introduction to VXI*, and Chapter 2, *Introduction to the NI-VXI Functions*, present the concepts of VXI and prepare you for detailed explanations of the NI-VXI functions. Study the descriptions of each function given in Chapters 3 through 13 to fully understand the purpose and syntax of each function.

Refer to the *NI-VXI Graphical Utilities Reference Manual* and the *NI-VXI Text Utilities Reference Manual* to learn more about the NI-VXI utilities.

## Related Documentation

---

The following documents contain information that you may find helpful as you read this manual:

- ANSI/IEEE Standard 1014-1987, *IEEE Standard for a Versatile Backplane Bus: VMEbus*
- ANSI/IEEE Standard 1155-1993, *IEEE VMEbus Extensions for Instrumentation: VXIbus*
- ANSI/VITA 1-1994, *VME64*
- VXI-6, *VXIbus Mainframe Extender Specification*, Rev. 1.0, VXIbus Consortium

## Customer Communication

---

National Instruments wants to receive your comments on our products and manuals. We are interested in the applications you develop with our products, and we want to help if you have problems with them. To make it easy for you to contact us, this manual contains comment and configuration forms for you to complete. These forms are in Appendix G, *Customer Communication*, at the end of this manual.

# Introduction

This chapter describes the VXIpc-850 Series of embedded VXI computers, lists what you need to get started, describes the hardware, and lists optional equipment and software.

Figure 1-1 shows the VXIpc-850 with its cover removed.

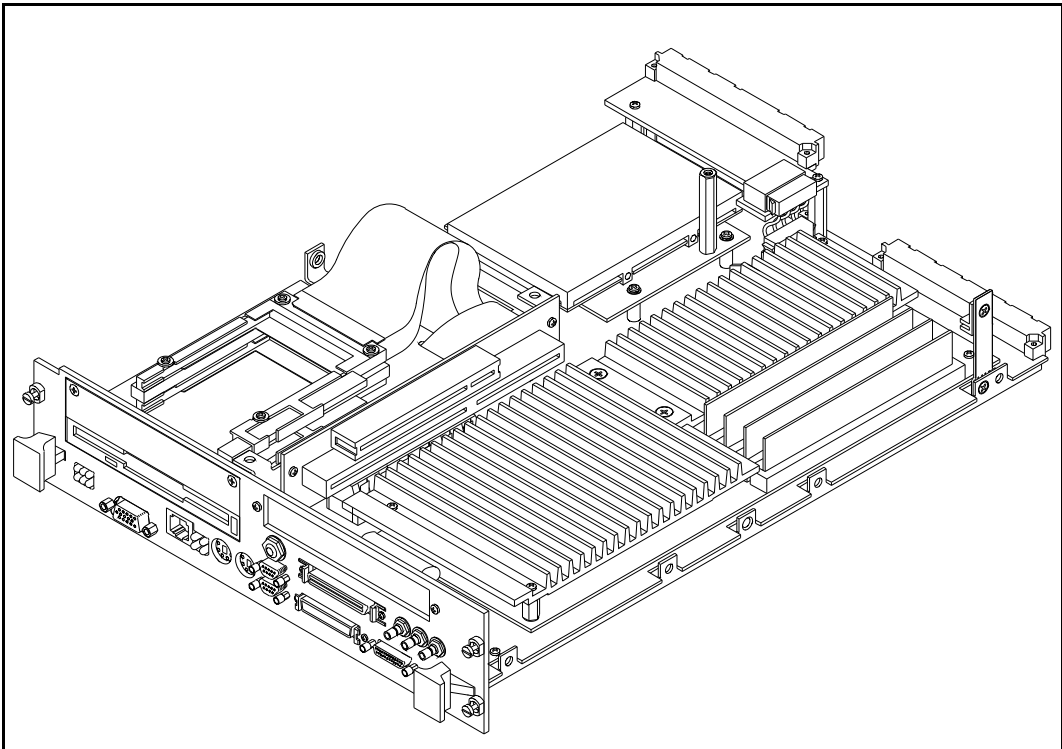

**Figure 1-1.** VXIpc-850 Embedded Computer

The VXIpc-850, a Pentium-based, C-size, embedded computer based on the Peripheral Component Interface (PCI) bus, is a high-performance, easy-to-use platform for controlling VXIbus systems, featuring complete VXI functionality through interactive utilities and C function calls. In addition, the VXIpc-850 has an IEEE 488.2 interface that is compatible with the NI-488.2 architecture.

The VXIpc-850 is a custom computer that you install directly in two C-size slots of your VXIbus mainframe. An embedded computer can take full advantage of the VXI high-performance backplane capabilities and give you direct control of VXI registers, memory, interrupts, and triggers.

All models in the VXIpc-850 Series are fully *VXIplug&play* compliant and are compatible with PC-compatible software tools, the National Instruments LabVIEW and LabWindows<sup>®</sup>/CVI application software, and the NI-VXI, NI-VISA, and NI-488.2 bus interface software.

## Optional Equipment

---

You can contact National Instruments to order any of the following optional equipment.

- COM1/2 adapter cable
- Enhanced parallel port adapter cable
- Single-shielded 2 m GPIB cable
- Upgrades for the VXIpc-850 modular CPU card

## Optional Software

---

National Instruments has developed several software kits that you can use with the VXIpc-850. The NI-VXI bus interface software for the VXIpc-850 includes a Resource Manager, graphical and text-based versions of an interactive VXI resource editor program, a comprehensive library of software routines for VXI/VME programming, and an interactive control program for interacting with VXI/VME. You can use this software to seamlessly program multiple-mainframe configurations and have software compatibility across a variety of VXI/VME controller platforms.

The NI-488.2 software kit for the VXIpc-850 gives you accessibility to the industry-standard NI-488.2 software for controlling external GPIB instruments through the GPIB port on the front panel of your



VXIpc-850. The GPIB interface on the VXIpc-850 is fully compatible with the NI-488.2 driver for a variety of operating systems. Any software using NI-488.2 will run on the VXIpc-850.

You can also use the National Instruments LabVIEW and LabWindows/CVI application programs and instrument drivers to ease your programming task. These standardized programs match the modular virtual instrument capability of VXI and can reduce your VXI/VMEbus software development time. These programs are fully VXI *plug&play* compliant and feature extensive libraries of VXI instrument drivers written to take full advantage of direct VXI control.

LabVIEW is a complete programming environment that departs from the sequential nature of traditional programming languages and features a graphical programming environment.

LabWindows/CVI is an interactive C development environment for building test and measurement and instrument control systems. It includes interactive code-generation tools and a graphical editor for building custom user interfaces.

LabVIEW and LabWindows/CVI include all the tools needed for instrument control, data acquisition, analysis, and presentation. When you order the LabVIEW VXI Development System for Windows or the LabWindows/CVI VXI Development System for Windows, you also get more than 500 complete instrument drivers, which are modular, source-code programs that handle the communication with your instrument to speed your application development.

## Hardware Description

---

The VXIpc-850 Series controllers feature a modular, PCI-based local bus design that makes it easy to use interchangeable daughterboards to upgrade your controller to new microprocessors, without having to replace the motherboard or enclosure. The VXIpc-850 Series currently consists of three models, which vary in the speed of the Intel Pentium microprocessor.

- The VXIpc-850/100 uses the 100 MHz version of the Intel Pentium microprocessor.
- The VXIpc-850/133 uses the 133 MHz version of the Intel Pentium microprocessor.
- The VXIpc-850/166 uses the 166 MHz version of the Intel Pentium microprocessor.

The CPU module and its memory sockets are easily accessible for you to install additional DRAM in the field—up to 128 MB. The VXIpc-850 contains at least an 800 MB internal, enhanced IDE hard disk. For information on adding RAM by installing SIMMs, refer to Appendix A, *Specifications*.

## Slot 0 Functionality

You can use the VXIpc-850 Series computers to achieve full VXI Slot 0 control of your VXI system. You can also install the VXIpc-850 in another slot and use it in Non-Slot 0 mode. You do not have to change any switches or jumpers when moving between these two modes, as the VXIpc-850 can automatically detect whether it is installed in Slot 0 and it will automatically enable or disable the Slot 0 onboard circuitry.

## Custom Application-Specific Interface Chips

The VXIpc-850 Series uses the MITE, MANTIS, and TNT4882C custom ASICs to deliver high VXI and GPIB performance, and can achieve more than 20 MB/s DMA block-mode data transfer rates across the VXI backplane.

The MITE custom ASIC is a sophisticated dual-channel DMA controller with standard interfaces for VXI and PCI. By using MITE DMA to transfer data and commands to and from devices, the MITE frees the computer's microprocessor to perform other tasks such as data analysis and presentation. In addition to DMA, the MITE incorporates the new VME64 MBLT (8-byte block transfers in which both the address bus and data bus are used to transfer data) directly into the ASIC to perform the fastest transfer operation to instruments. With the multiple windowing scheme of the MITE, you can easily access all of VXI address space.

The VXI trigger interface on the VXIpc-850 is based on the MANTIS custom ASIC. By using the two SMB trigger I/O connectors on the front panel, you can route any of the TTL trigger lines between the backplane and external devices. The MANTIS provides the complete VXI interface to the backplane connector in a single chip. The VXIpc-850 can respond to all VXI-defined protocols on all P2 TTL and ECL trigger lines at the same time. The MANTIS features an internal cross-matrix switching system for routing between lines as well as to and from the front panel and onboard clocks.

The VXIpc-850 uses the TNT4882C custom ASIC to give full GPIB control of external instruments via a front-panel connector. GPIB

capability is fully compatible with IEEE 488.2 and the industry-standard NI-488.2 driver for a variety of operating systems.

## Front Panel Features

The VXIpc-850 has the following front-panel features.

- Two PCMCIA slots (one Type I/II and one Type I/II/III)
- One full-size expansion slot that accepts either a PCI or a PC ISA (XT-height) plug-in board
- Internal 3.5 in. floppy drive
- 13 front-panel connectors
  - RS-232 serial connector (two miniature)
  - Extended capabilities parallel (ECP) connector
  - VGA controller connector
  - IEEE 488.2 connector
  - 10BaseT Ethernet connector
  - SCSI-2 connector
  - External clock connector
  - Trigger output connector
  - Trigger input connector
  - Audio output connector
  - PS/2-style keyboard connector
  - PS/2-style mouse connector
- System reset push-button
- Six front-panel LEDs that show VXI and PC status
  - **SYSFAIL** LED indicates that the VMEbus SYSFAIL line is asserted.
  - **FAILED** LED indicates that the VXIpc-850 is driving the SYSFAIL signal.
  - **TEST** LED indicates that the VXIpc-850 is performing its self-tests or startup Resource Manager operations.
  - **ON LINE** LED indicates that the VXIpc-850 is performing or has completed its startup Resource Manager operations.
  - **ACCESS** LED indicates when the VXIpc-850 MODID line is asserted or the VXIbus registers or shared memory are accessed by another bus master.
  - **DRIVE** LED indicates when the internal hard drive is in use.

- Four front-panel LEDs that show Ethernet port status
  - **RX** LED indicates that the VXIpc-850 is receiving data through its Ethernet port.
  - **TX** LED indicates that the VXIpc-850 is transmitting data through its Ethernet port.
  - **DSEL** LED indicates that the Ethernet circuitry is being accessed.
  - **LINK** LED reflects Ethernet link status.

## Peripheral Expansion

The VXIpc-850 uses the PCI local bus for peripheral expansion. The PCIbus is a 32-bit multimaster bus that achieves a top throughput of 132 MB/s and can handle numerous peripherals. The integrated PCI local bus design of the VXIpc-850 gives you access to the following peripherals:

- PCMCIA
- SCSI-2
- Super VGA
- Enhanced IDE for the hard drive

For information on installing and configuring these peripherals for use with the VXIpc-850, refer to Chapter 5, *Peripherals*. You can also refer to the *VXIpc-850 Peripherals User Manual*, which contains full documentation for the video, PCMCIA, and SCSI peripherals.

# Functional Overview

---

This chapter contains functional descriptions of each major logic block on the VXIpc-850 Series embedded computer.

## VXIpc-850 Functional Description

---

The VXIpc-850 is a modular PC in a dual-slot VXIbus C-size form factor. It includes many high-performance peripherals that normally require add-in cards on desktop PCs. In addition, it has a VXIbus interface that is controlled from the PCI local bus, providing extremely high performance and reliability.

Figure 2-1 is a functional block diagram of the VXIpc-850. Following the diagram is a description of each logic block shown.

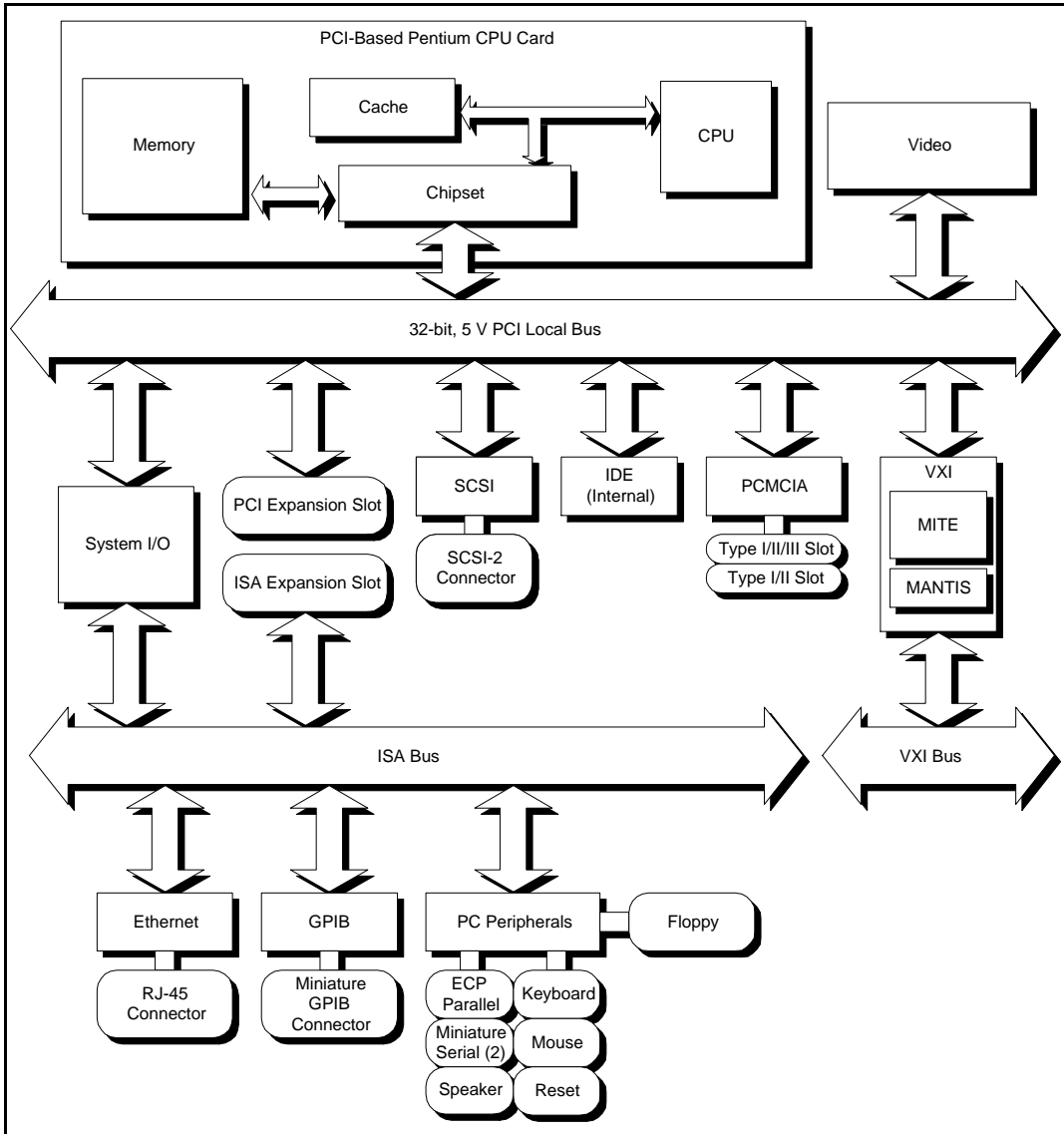

Figure 2-1. VXIpc-850 Block Diagram

The VXIpc-850 consists of the following logic blocks:

- **CPU Card** The modular architecture of the VXIpc-850 contains a plug-in CPU card that can accommodate various Pentium-class processors. This card includes the CPU, chipset support that connects the CPU subsystem to the PCI bus, and the system cache and RAM.
- **Video** The video circuitry is a plug-in PCI card that has a 64-bit data path to up to 4 MB of EDO DRAM.
- **System I/O** This block has the bridge between the PCI bus and the ISA bus. It also has PCI bus arbitration logic and integrates PC-specific hardware such as the DMA and interrupt controllers.
- **PCI Expansion Slot** This is a general-purpose PCI slot. It can accommodate any standard 5 V, 32-bit PCI card with a modified mounting bracket.
- **ISA Expansion Slot** This is a general-purpose ISA expansion slot. It can accommodate a full-length XT-size card; however, the DRAM configuration may mechanically interfere with a full-length card. Refer to Appendix E for more information.
- **SCSI** The SCSI circuitry uses a PCI-SCSI bridge to provide a flexible SCSI-2 connection on the front panel, usable for such devices as external hard disks and CD-ROM drives.
- **IDE** This is a dedicated PCI-IDE chip providing fast ATA-2 transfers to the internal hard drive.
- **PCMCIA** This is a dedicated PCI-PCMCIA interface that supports two independent PCMCIA cards. One socket can accommodate a Type I, II, or III card while the other accommodates a Type I or II card.
- **VXI** This is the PCI-VXIbus interface circuitry. The MITE is a National Instruments ASIC developed to efficiently manage data transfers between the VXIbus and the processor (via the PCI bus). The MANTIS ASIC (also developed by National Instruments) performs VXIbus arbitration and manages interrupts and triggers. Also part of the VXIbus interface are the SMB connectors, which you can use to route triggers and the CLK10 signal to or from the VXIbus.
- **Ethernet** This is an ISA-based Ethernet circuit that uses an RJ-45 connector for access to an external Ethernet-based LAN.
- **GPIB** This logic block represents the IEEE 488.2 port on the VXIpc-850. It uses the National Instruments TNT4882 ASIC for maximum performance as an ISA-based GPIB controller.
- **PC Peripherals** These blocks represent the other peripherals supplied by the VXIpc-850, including PS/2 mouse and keyboard ports, two miniature serial ports, and ECP/EPP parallel port, speaker jack, reset button, and a 1.44 MB, 3.5 in. floppy drive.

# Configuration and Installation

---

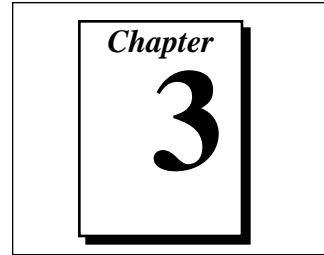

This chapter contains the instructions to configure and install the VXIpc-850 Series embedded computer. Unless otherwise noted, these instructions apply to all models in the VXIpc-850 Series.



**Warning:** *Electrostatic discharge can damage several components on your VXIpc-850 module. To avoid such damage in handling the module, touch the antistatic plastic package to a metal part of your VXI chassis before removing the VXIpc-850 from the package.*

## Default Settings

---

This section summarizes the hardware default settings for the VXIpc-850 for easy reference. The VXIpc-850 is set at the factory for the most commonly used configuration.

Figure 3-1 shows the location and factory-default settings of most of the configuration switches and jumpers on the VXIpc-850.



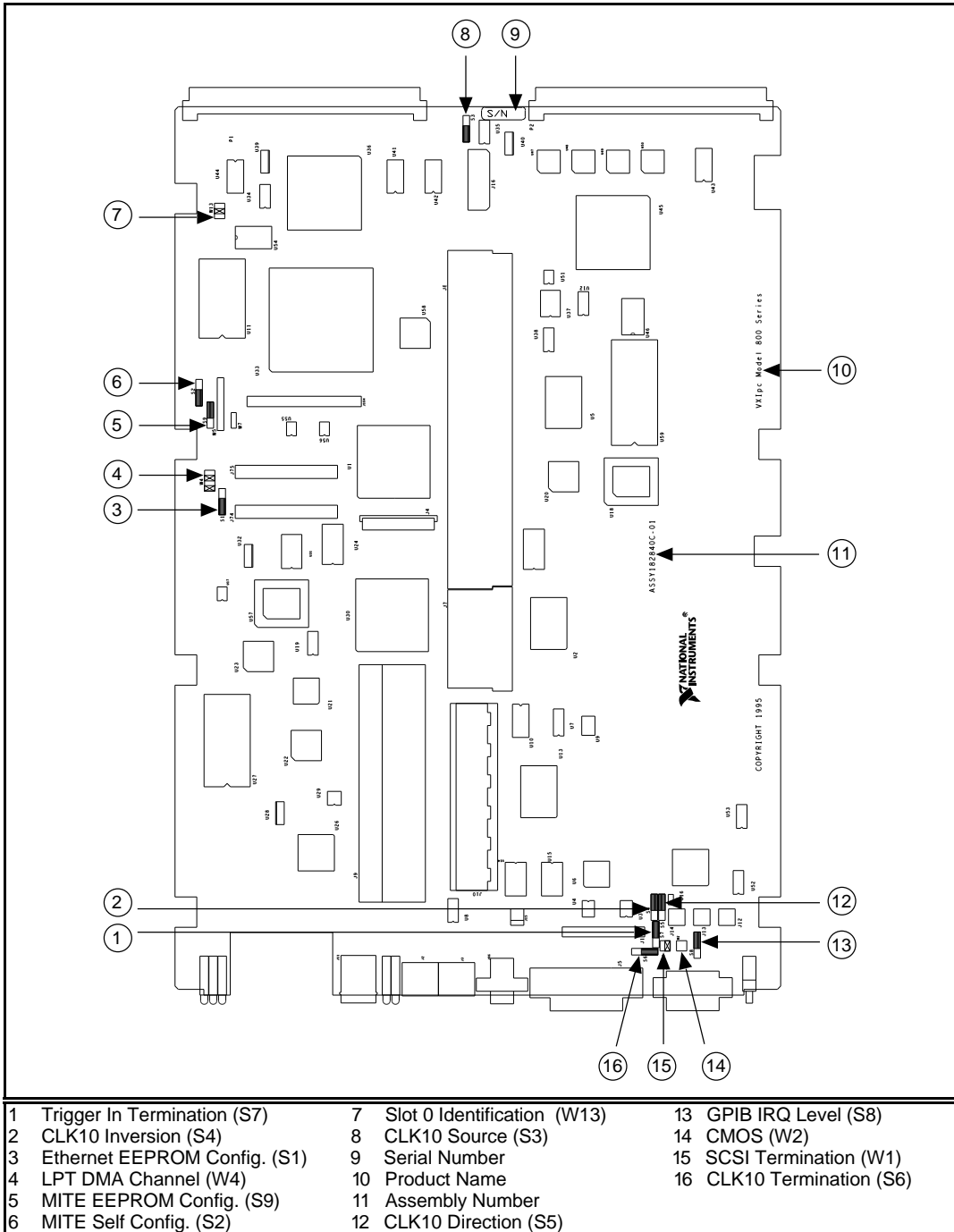

Figure 3-1. VXIpc-850 Parts Locator Diagram

Table 3-1 lists the factory-default settings and options for the onboard jumpers and switches.

Table 3-1. VXIpc -850 Hardware Default Settings

<b>Jumper/ Switch</b>	<b>Default Setting</b>	<b>Optional Setting</b>
W1	Supply SCSI termination power	Disable SCSI termination
W2	Normal CMOS operation	Clear CMOS
W4	LPT1 uses DMA Channel 1	LPT uses DMA Channel 3
W13	Enable automatic Slot 0 detection	Force Slot 0; Force Non-Slot 0
S1	Enable Ethernet EEPROM configuration	Disable Ethernet EEPROM configuration (uses default power on values)
S2	Enable MITE self-configuration	Disable MITE self-configuration
S3	Source CLK10 from onboard oscillator	Source CLK10 from SMB
S4	Non-inverted CLK10 output	Inverted CLK10 output
S5	Receive CLK10 input from SMB	Source CLK10 output to SMB
S6	No termination on CLK10 input	Terminate CLK10 input to 50 $\Omega$
S7	No termination on external trigger input	Terminate external trigger input to 50 $\Omega$
S8	GPIB uses IRQ11	GPIB uses IRQ5
S9	MITE user configuration	MITE factory configuration

## Configuring the VXIpc-850

---

This section describes how to configure the following options on the VXIpc-850.

- VXIbus Slot 0/Non-Slot 0
- VXIbus CLK10 routing
- Trigger input termination
- EEPROM
- Installed system RAM

### How to Remove the Metal Enclosure

The VXIpc-850 is housed in a metal enclosure to improve EMC performance and to provide easy handling. You must remove this enclosure to change many of the switch and jumper settings on the VXIpc-850. You must also remove the enclosure to change the amount of DRAM installed on the VXIpc-850.

To remove the metal enclosure, remove the five screws on the top, the four screws on the bottom, and the three screws on the right side of the enclosure.

### VXIbus Slot 0/Non-Slot 0

The VXIpc-850 is configured at the factory to automatically detect if it is installed in Slot 0 of a VXIbus mainframe. With automatic Slot 0 detection, you can install the VXIpc-850 into any VXIbus slot.

You can manually configure the VXIpc-850 for either Slot 0 or Non-Slot 0 operation by defeating the automatic-detection circuitry. Use the three-position jumper W13 to select automatic Slot 0 detection, Slot 0, or Non-Slot 0 operation. Figure 3-2 shows these three settings.



**Warning:** *Do not install a device configured for Slot 0 into another slot without first reconfiguring it to either Non-Slot 0 or automatic configuration. Neglecting to do this could result in damage to the device, the VXIbus backplane, or both.*

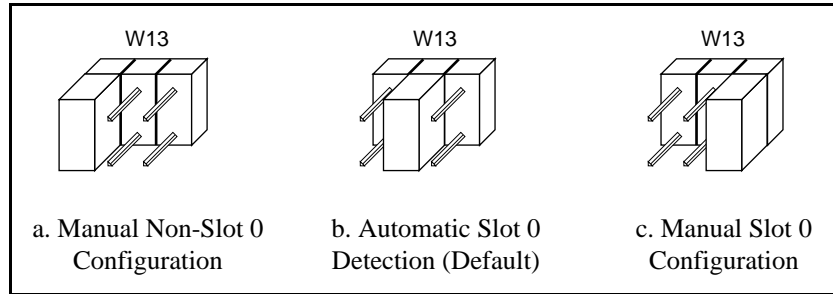

Figure 3-2. VXIbus Slot Configuration

When the VXIpc-850 is installed in Slot 0, it becomes the VXIbus System Controller. In this role, it has VXIbus Data Transfer Bus Arbiter circuitry that accepts bus requests on all four VXIbus request levels, prioritizes the requests, and grants the bus to the highest priority requester. As VXIbus System Controller, the VXIpc-850 also drives the 16 MHz VXIbus system clock by an onboard 16 MHz oscillator.

As required by the VXIbus specification, the VXIpc-850 drives the 10 MHz signal CLK10 on a differential ECL output when installed in Slot 0. When not installed in Slot 0, the VXIpc-850 only receives the CLK10 signal.

## VXIbus CLK10 Routing

When the VXIpc-850 is installed in Slot 0 of your mainframe, it supplies the VXIbus CLK10 signal. The VXIpc-850 can use two different sources to generate this signal: an onboard oscillator, or the external CLK SMB connector. Use switch S3 to select these options, as shown in Figure 3-3.

Notice that Figure 3-3b also shows switch S5. You must configure these switches as shown when using the corresponding CLK10 source setting of S3.

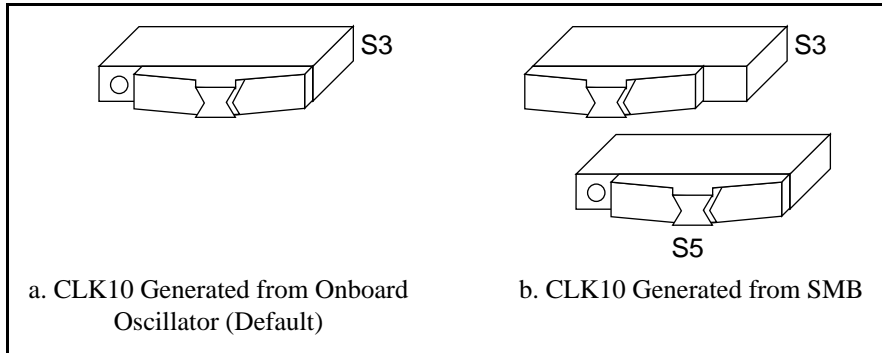

Figure 3-3. VXIbus CLK10 Routing

The VXIpc-850 can also be configured to drive the external CLK SMB signal from the VXIbus CLK10 signal. Switch S5 controls whether the VXIpc-850 drives or receives the external CLK SMB signal. If you change the S5 setting to drive CLK10 out the external CLK10 SMB connector (Figure 3-4b), do not set S3 to source CLK10 to the backplane from the SMB; instead use the setting shown in Figure 3-3a.

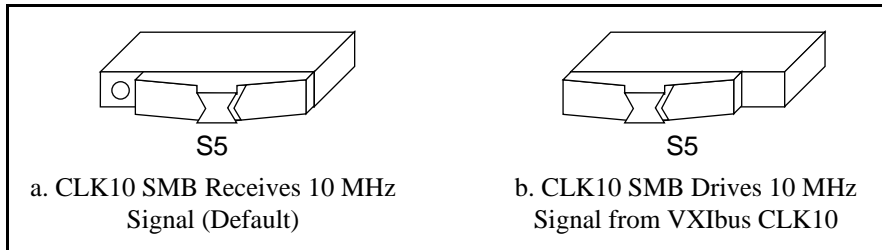

Figure 3-4. SMB CLK10 Direction

When switch S5 is set so that the VXIpc-850 receives the SMB CLK10 signal, you have the option to add a 50  $\Omega$  termination to the signal by setting switch S6. Switch S6 is unused—its setting does not matter—when S5 is configured to drive the external CLK SMB signal. Figure 3-5 shows the settings for switch S6.

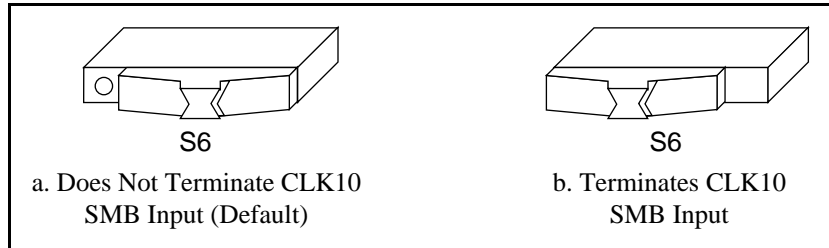

Figure 3-5. SMB CLK10 Termination

You can use an additional switch, S4, to control the polarity of the external CLK SMB signal when S5 is configured to drive it. S4 is unused—its setting does not matter—when S5 is configured to receive the external CLK SMB signal.

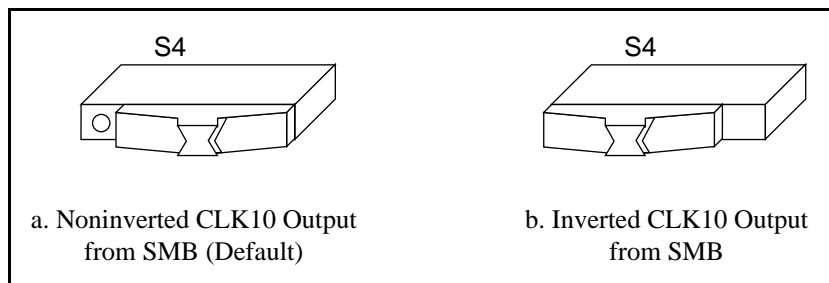

Figure 3-6. SMB CLK10 Polarity

## Trigger Input Termination

You can use switch S7 to terminate the external trigger input SMB with 50  $\Omega$  to ground. Figure 3-7a shows the default setting for a non-terminated trigger input SMB. Use the setting of Figure 3-7b to terminate the trigger input SMB. Switch S7 is located above switches S4, S5, and S6, which have no effect on this configuration.

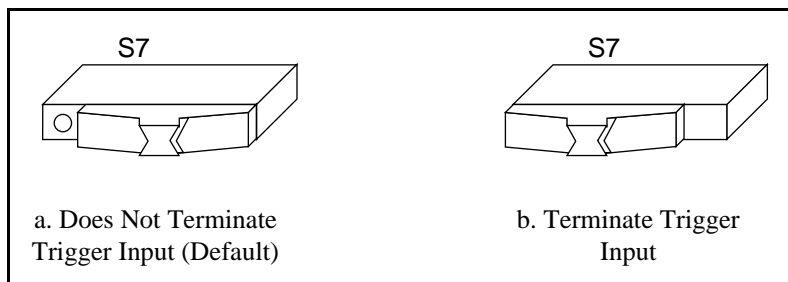

Figure 3-7. SMB Trigger Input Termination

## EEPROM

The VXIpc-850 has an onboard EEPROM, which stores default register values for the VXI circuitry. These values are loaded when you power up the computer. These values read from the EEPROM tell the PCI interface of the VXIbus registers so that the VXI interface is ready to respond to resource manager accesses within the required 5 s of SYSRST\* deasserting. You can disable this power-on self-configuration circuit using switch S2. Although this makes the VXI circuitry unusable, it is sometimes helpful in debugging address and interrupt conflicts with add-in boards. In general, however, you should leave switch S2 in its factory-default setting. Figure 3-8 shows the possible configurations for S2.

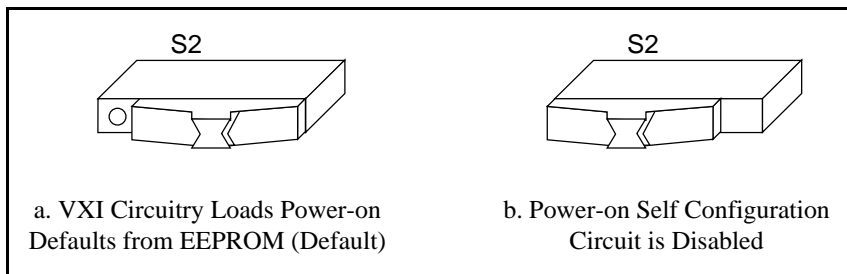

Figure 3-8. Power-On Self Configuration Status

The EEPROM is divided into two halves; one half is factory configured and one half is user configurable. Use switch S9 to control the operation of the EEPROM. The setting of this switch determines whether the VXIpc-850 boots off the factory-configured half or the user-modified settings. This is useful in the event that the user-configured half of the EEPROM becomes corrupted in such a way that the VXIpc-850 boots to an unusable state. In its default setting, the VXIpc-850 boots off the user-configurable half.

Figure 3-9 shows the configuration settings for EEPROM operation.

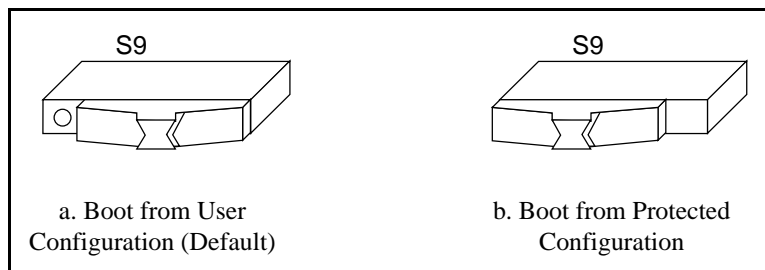

Figure 3-9. SMB Trigger Input Termination

## How to Fix an Invalid EEPROM Configuration

VXIEDIT is the software configuration utility in the NI-VXI software. This utility is described in Chapter 3, *NI-VXI Configuration Utility*, in the *NI-VXI Software Manual for the VXIpc-850 Series*. You can use this utility to edit the configuration of the VXIpc-850. Some of these settings are stored in files that are read by the NI-VXI software, while other settings are stored directly in the VXIpc-850 EEPROM. Certain EEPROM configurations can lock up your PCI computer while it is booting up. Generally, only the size and location of the memory windows can cause your VXIpc-850 to lock up your system. For example, many PCI-based computers will not boot if a board in its system requests more memory space than the computer can allocate. If you encounter this situation you should reduce the size of the VXIpc-850 user window.

If this situation occurs after you change the VXIpc-850 configuration, perform the following steps to reconfigure the VXIpc-850.

1. Turn your computer off.



**Warning:** *To protect both yourself and the mainframe from electrical hazards, the mainframe should remain off until you are finished changing the settings on the VXIpc-850 module.*

2. Change switch S9 to the OFF position as shown in Figure 3-9b to restore the factory configuration.

## Installed System RAM

The 11 MB of installed RAM is factory configured per customer order. You can change the amount of installed RAM on the VXIpc-850 by installing DRAM SIMMs. Refer to Appendix A, *Specifications*, for more information on SIMMs.

## Configuring the PC

---

This section describes how to configure the following options on the PC.

- SCSI termination
- GPIB interrupt level
- System CMOS
- Parallel port DMA level
- Ethernet power-on defaults



## SCSI Termination

The VXIpc-850 uses active termination on the SCSI-2 bus. Because the VXIpc-850 is always an end device, you should not need to disable the termination; however, Figure 3-10 shows the settings for jumper W1.

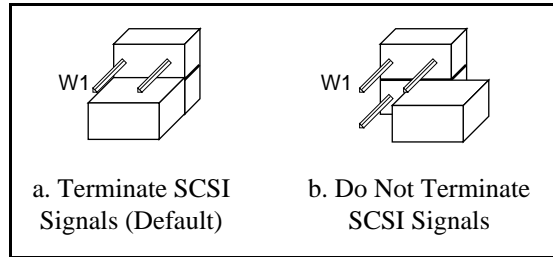

Figure 3-10. SCSI Termination

## GPIB Interrupt Level

You can program the GPIB interface on the VXIpc-850 to use one of two ISA interrupts—5 or 11. Switch S8 controls which interrupt line the GPIB interface uses. Figure 3-11 shows these settings.

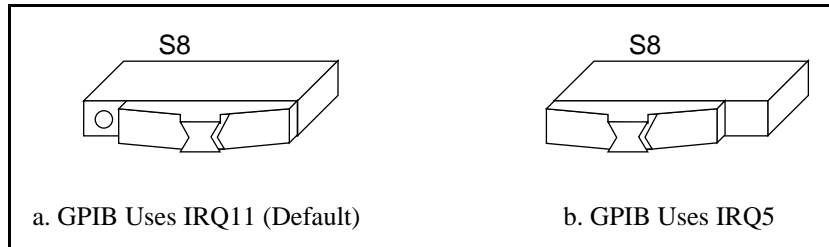

Figure 3-11. GPIB Interrupt Level

## System CMOS

The VXIpc-850 contains a backed-up memory used to store BIOS defaults and configuration information.

To clear the CMOS contents, simply short the pins of W2 as shown in Figure 3-12b.



**Warning:**

***You should not keep these two pins shorted because the CMOS memory cannot be sustained when the power is turned off if these two pins are shorted.***

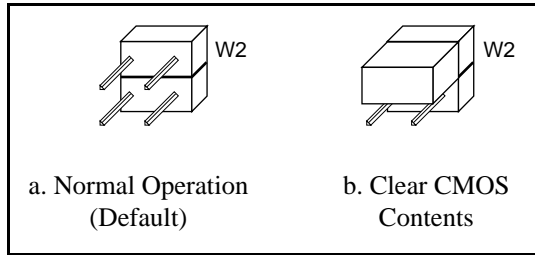

Figure 3-12. System CMOS

## Parallel Port DMA Level

You can use jumper W4 to configure the parallel port for either DMA level 1 or DMA level 3. Refer to Figure 3-13 for the jumper settings.

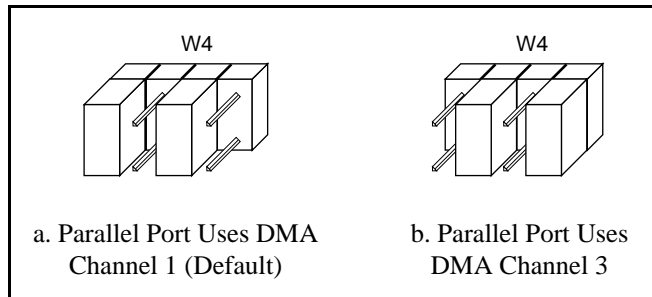

Figure 3-13. Parallel Port DMA Channel

## Ethernet Power-On Defaults

The VXIpc-850 Ethernet circuitry loads its power-on settings from an EEPROM. Switch S1 should not be changed from its default setting; however, the directions to do so are included here for informational purposes. Figure 3-14 shows the settings.

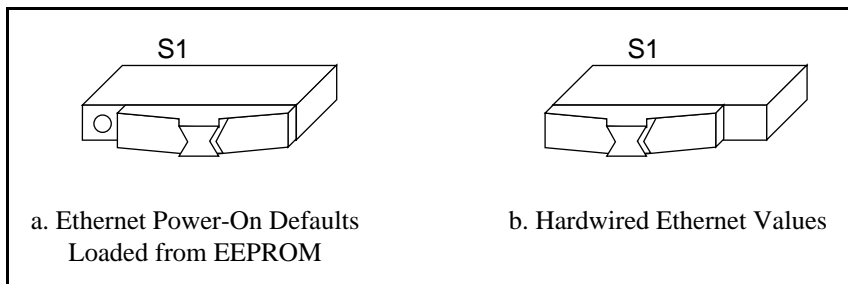

Figure 3-14. Ethernet Power-On Defaults

## Installing the VXIpc-850

---

This section contains general installation instructions for the VXIpc-850. Consult your VXIbus mainframe user manual or technical reference manual for specific instructions and warnings.

1. Plug in your mainframe before installing the VXIpc-850. The power cord grounds the mainframe and protects it from electrical damage while you are installing the module.



**Warning:** *To protect both yourself and the mainframe from electrical hazards, the mainframe should remain off until you are finished installing the VXIpc-850 module.*

2. Remove or open any doors or covers blocking access to the mainframe slots.
3. If you are installing the VXIpc-850 into a D-size mainframe, install a support designed for installing C-size boards in D-size mainframes. The VXIpc-850 has no P3 connector and cannot provide P3 Slot 0 control to VXI devices requiring this capability.



**Warning:** *If the VXIpc-850 is not configured for automatic Slot 0 detection, be certain that the slot you select in your VXIbus mainframe matches the VXIpc-850 configuration as either a Slot 0 device or a Non-Slot 0 device. If you install your VXIpc-850 into a slot that does not correspond with the jumper setting, you risk damage to the VXIpc-850, the VXIbus backplane, or both.*

4. Insert the VXIpc-850 in the slot you have selected by aligning the top and bottom of the board with the card-edge guides inside the mainframe. Slowly push the VXIpc-850 straight into the slot until its plug connectors are resting on the backplane receptacle connectors. Using slow, evenly distributed pressure, press the VXIpc-850 straight in until it seats in the expansion slot. The front panel of the VXIpc-850 should be even with the front panel of the mainframe.
5. Tighten the retaining screws on the top and bottom edges of the front panel.
6. Check the installation.
7. Connect the keyboard and mouse to the appropriate connectors. Use the keyboard adapter cable that you received with your kit to adapt AT-style keyboards to the VXIpc-850 mini-DIN connector.
8. Connect the VGA monitor video cable to the VGA connector.

9. Connect devices to ports as required by your system configuration. Some ports, such as the COM ports, have adapter cables that you can order from National Instruments.
10. Replace or close any doors or covers to the mainframe.

# WinBIOS

---

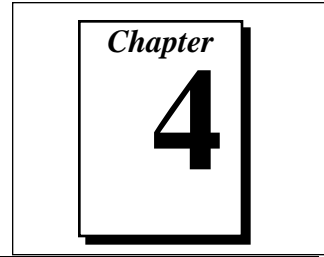

This chapter contains information on WinBIOS, the low-level interface between the hardware and PC software that configures and tests your hardware at boot up. This BIOS (Basic Input Output System) provides an easy-to-use graphical user interface to allow you to configure system aspects according to your needs.

## Entering WinBIOS Setup

---

To enter the WinBIOS setup program, perform the following steps.

1. Turn on or reboot the system. A screen appears with a series of diagnostic checks.
2. When **Hit <DEL> if you want to run SETUP** appears, press the <DEL> key to enter the BIOS setup program.
3. Choose options with the keyboard or mouse. Modify the settings to reflect system options. Press <Alt-H> for Help.

## Using a Mouse with WinBIOS Setup

Point the cursor at the item you wish to modify and double-click the left mouse button. When items appear, use the cursor to select values and press the left mouse button to complete the changes. To leave the current operation and return to the previous level, click on the exit box in the window's upper left corner.

## Using the Keyboard with WinBIOS Setup

Although using the mouse is the easiest means to select BIOS options, you can also use the keyboard. Table 4-1 lists the keys you use to choose options:

Table 4-1. WinBIOS Options

Key	Option
<TAB>	Change current window
>, <, ^, v	Move highlight to next field
<Enter>	Select highlighted option
+, -	Increment or decrement a value
<ESC>	Close the current operation and return to the previous level (exits WinBIOS at the top level)
<PgUp>	Return to previous page
<PgDn>	Advance to next page
<Home>	Return to the beginning of the text
<End>	Advance to the end of the text
<Alt-H>	Access a help window
<Alt-space>	Exit WinBIOS setup

# WinBIOS Main Menu

The WinBIOS main menu has four windows, each of which includes several options. Table 4-2 lists descriptions for each of the main menu windows.

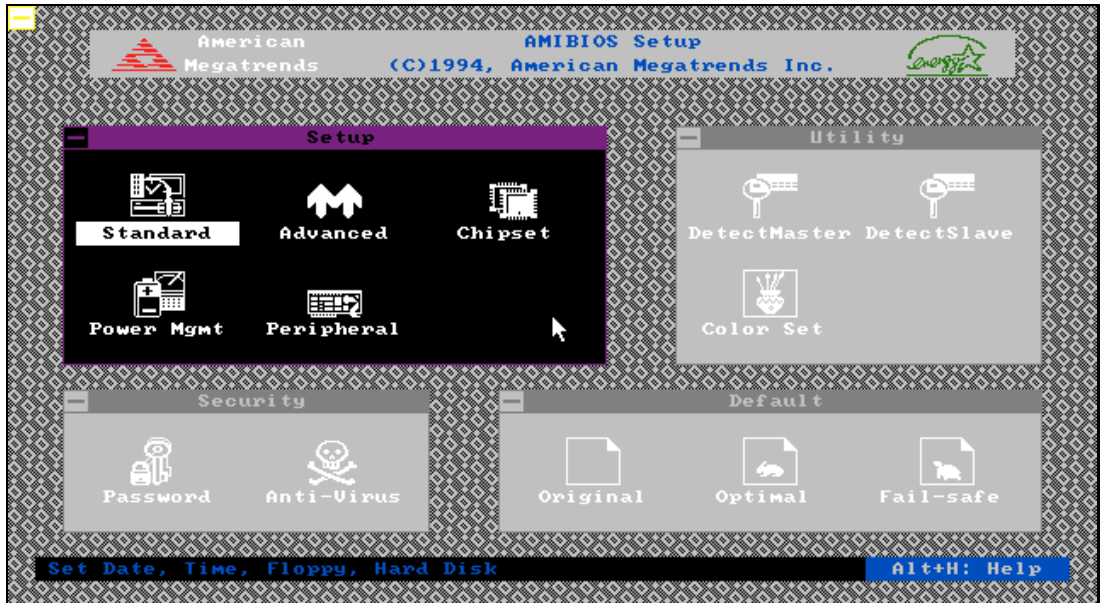

Table 4-2. WinBIOS Main Menu Windows

Window	Description
Setup	Has five icons you can use to set system configuration options such as time, date, hard disk, floppy disk, and chip specific parameters.
Utility	Has three icons you can use to detect hard drive types and change screen colors.
Security	Has two icons you can use to control password and anti-virus settings
Default	Has three icons you can use load original, optimal, and fail-safe BIOS settings

For more detailed information, type <ALT+H> to access online help.

# Peripherals

This chapter contains brief descriptions of each of the peripheral components of the VXIpc-850 Series embedded computer. Table 5-1 lists the VXIpc-850 peripheral components. Refer to the *VXIpc-850 Peripherals User Manual* for more complete information on each peripheral.

Table 5-1. VXIpc-850 Peripheral Components

Peripheral	External Connector	ISA- or PCI-Based	Function
Video	15-pin DSUB (std VGA)	PCI	High-resolution/color support for a SuperVGA monitor
IDE	None	PCI	Supports internal fast ATA-2 hard drive
Ethernet	RJ-45	ISA	10BaseT Ethernet connection
PCMCIA	Type I/II and Type I/II/III	PCI	Supports two independent PCMCIA slots
SCSI	36-pin SCSI-2	PCI	External SCSI-2 connection for hard drives, CD-ROM drives, and so on
GPIB	24-pin CHAMP	ISA	IEEE 488.2 interface compatible with the National Instruments AT-GPIB board
VXI	Two 96-pin DIN (rear of board) Serial Port Parallel Port	PCI ISA ISA	High-performance VXIbus interface 16550 Serial ports Extended capabilities



## Software Installation

---

Your VXIpc-850 is one of the most complete PCs available on the market, including desktop PCs. The VXIpc-850 includes video, IDE, Ethernet, PCMCIA, SCSI, and GPIB, all of which require software support to either enable them or maximize their performance. This chapter contains information on how to install these drivers.

### Why National Instruments Does Not Install All Peripheral Drivers

Although all drivers run concurrently with each other and can all run together, each driver uses a certain amount of system resources. Depending on the peripheral, these resources include DMA channels, interrupts, or main memory. The latter is especially critical in a DOS environment, where available memory can be as little as 400 KB with all drivers loaded.

Because most VXIpc-850 users require some subset of the peripherals offered, National Instruments allows the customer to determine where system resources should be allocated, whether to peripherals, PCI or ISA add-in boards, or applications.

### Installing Peripheral Drivers

Find the `c:\images` directory in the root directory of your internal hard drive. In it are subdirectories that contain images of the installation diskettes for the peripheral drivers.

For most of the drivers, installation simply requires you to change to the appropriate subdirectory (for example, change to `c:\images\enet` for the Ethernet driver) and run the install or setup program. Some drivers do require extra steps, so read the installation instructions before installing the driver.

For more information on SCSI, video, or PCMCIA, refer to the *VXIpc-850 Peripherals User Manual*.

# Video

---

The VXIpc-850 uses the TGUI96XX Series Video Accelerator from Trident Microsystems. For space and modularity reasons, National Instruments designed a PCI-based video card using the TGUI96XX and up to 4 MB of EDO DRAM. The performance of this card rivals that of any other 64-bit graphics card on the market.

With 4 MB of DRAM, the TGUI96XX supports up to 1600x1200 resolution (65 KB colors maximum) or up to 16.7 million colors (1280x1024 resolution maximum). You can also select the refresh rate at which you would like the video circuitry to operate.



**Caution:** *If you are using a Super VGA monitor, make sure it has a horizontal scan rate of at least 50 kHz and a vertical scan rate of 60 Hz. Using the Super VGA option with a monitor that does not meet these criteria will damage your monitor.*

You do not need to install the video drivers. The TGUI96XX driver software comes installed on your hard disk with a default configuration 640x480 resolution at 16 colors and a 60 Hz refresh rate. This setting was chosen to accommodate all VGA monitors; however, you may want to increase the resolution, colors, and refresh rate according to the capabilities of your monitor. Within Windows 3.1, in the Display Driver and Utilities program group, you will find the TGUI96XX utilities described in the Trident manual.

For archival purposes, an image of the TGUI96XX installation files are provided in `c:\images\video`.

## About the Trident Video Manual

In addition to the driver software, Trident Microsystems provides documentation to its OEM customers. Refer to the *VXIpc-850 Peripherals User Manual* for more information.

## Technical Information about the Video Interface

The TGUI96xx video accelerator has a 32-bit, 5 V PCI interface for communication with the processor. It provides a dedicated 64-bit path to the video memory. In the National Instruments implementation, it interfaces to 70 ns EDO DRAM. There is 70 ns EDO DRAM instead of

60 ns EDO DRAM because there was no measurable performance increase.

The following provides information about the bootstrap settings on the TGUI96XX and is for users already familiar with the TGUI96XX.

- Pulldown resistor on MD(4): Select PCI interface
- Pulldown resistor on MD(23): Enable DDC
- Pulldown resistor on MD(15): Provide eight CAS lines and defining CAS0# as WE#
- Pulldown resistor on MD(7): Select EDO DRAM
- Pulldown resistor on MD(0): Memory Clock select 0
- No pulldown resistor on MD(1) nor MD(3): Select 70 ns memory speed

## IDE

---

The VXIpc-850 uses the CMD0640B PCI-IDE controller from CMD Corporation. The chip supports two IDE ports although the VXIpc-850 only uses one IDE port. In order to take advantage of the advanced features of the CMD0640B, install the QuickIDE driver as described in the next section.

### Installing the IDE Software

Perform the following steps to install the QuickIDE driver.

1. If you are running under DOS or Windows 3.x, an image of the CMD QuickIDE software resides in `c:\images\ide`. (If you are running Windows 95, the `c:\images\ide` directory will not exist. Windows 95 includes a driver for the CMD0640B, so separate installation is not necessary.) Under DOS or a DOS shell under Windows, type `c:\images\ide\install` to install the driver.
2. Once QuickIDE installation loads, you will be guided through the installation process with a series of prompts and dialogs. If you have a mouse, be sure to load your mouse driver first. If you do not have a mouse, use the arrow keys to move within a field and use the <TAB> key to move from one field to another. To select a button or menu, hold down <ALT> while pressing the underlined letter in the button or menu.

3. After you have answered all the questions, QuickIDE will copy files to the `c :` drive and perform edits to files as needed. Backup copies of any altered files will be created in case you want to undo the installation. QuickIDE may modify `CONFIG.SYS` and/or `AUTOEXEC.BAT`. The original files will be renamed `CONFIG.000`, and so on.

## Technical Information about the IDE Interface

In addition to the CMD part, two other devices provide IDE interfaces. The Intel 82091AA Advanced Integrated Peripheral (AIP) provides floppy, parallel, and serial support and has an IDE interface. The IDE interface is disabled because the AIP is not a PCI-based part and therefore provides a slower IDE interface than the CMD0640B. The Intel 82092AA PPEC (described in the *PCMCIA* section) provides a PCI-IDE interface; however, PCMCIA performance is restricted when that interface is enabled. Disabling the IDE on the PPEC provides maximum PCMCIA flexibility and performance.

The CMD0640B is configured so that the PCI base address registers are enabled, setting the IDE port to Legacy Mode or Native Mode with software. In Legacy Mode, the CMD0640B is compatible with standard ISA IDE. The IDE registers are mapped to the standard ISA port addresses and the IDE drive interrupt occurs at IRQ14. In PCI IDE Native Mode, the CMD0640B task file registers may be mapped to nonstandard port addresses and hard drive interrupts occur on a PCI interrupt. On the VXIpc-850, the PCI interrupt used is INTD.

The following describes the other options selected in the IDE circuitry on the VXIpc-850.

- Chip ID Port Address Decoding is disabled
- Device ID Port Address is 0x178
- Device ID is 0x60 (the only option for a system with one CMD0640B)
- Drive Address Register is disabled

The above options should not affect most users and are provided for informational purposes to those already familiar with the CMD0640B. PCI configuration utilities in the BIOS (and in Windows 95) will detect the CMD0640B and program the necessary values.

# Ethernet

---

The VXIpc-850 uses the SMC 91C92 ISA-Ethernet controller from Standard Microsystems Corporation as a 10BaseT node. The VXIpc-850 provides four diagnostic LEDs that are activated by transmit-and-receive activity, by link integrity status, and when the 91C92 register space is accessed.

The 91C92 supports IEEE 802.3 and you can reconfigure it without changing jumpers. In addition, it does not require any memory space, using 16 bytes of I/O space for all communication.

## Configuring Your Ethernet Addresses

National Instruments programs the Ethernet address and other values into a serial EEPROM from which the 91C92 loads its power-on configuration. The defaults should be adequate for most situations; however, using the ISMC9000 software, you can change the default settings (except the Ethernet address) for the needs of your system.

Table 5-1. SMC 91C92 Default Settings

Settings	
Ethernet Address	00:80:2F:01:xx:xx
I/O Base Address	0x300
ROM Base Address	N/A
8/16 Bit Adapter	16-bit
Interface	10BASE T
Interrupt Line	IRQ9

## Installing the Ethernet Software

Perform the following steps to install the Ethernet driver.

1. The ISMC9000 software resides in `c:\images\enet`. Under DOS or a DOS shell under Windows, type `c:\images\enet\ismc9000` to run the configuration program. If you do not want to change the default settings, you do not need to run this program.

2. Once you exit the ISMC9000 program, the serial EEPROM is updated and the values you selected are loaded into the 91C92 the next time you boot the machine.
3. At this point, you need to install the appropriate network driver unless you can use one of the network drivers included with the operating system. For example, some operating systems may not include TCP/IP.

If the driver you need is not supplied in the `c:\images\enet` directory, you can either contact National Instruments for help on finding the driver you need or, if you have internet access, you can access the Microsoft WWW or FTP sites, which contain some standard network drivers.

To install the network driver, follow the instructions in the appropriate driver installation document.

## Technical Information about the Ethernet Interface

The SMC 91C92 provides the designer with the ability to select external or internal I/O decoding and the ability to select whether or not it responds to 16-bit accesses. The 91C92 on the VXIpc-850 decodes its own addresses (the ENDEC\* pin is tied high) and is enabled for 16-bit accesses (EN16\* is tied low).

## Support

You can contact SMC at the following numbers to obtain technical support:

New York: (8:30 AM - 6:00 PM Eastern Time)

(800) 992-4762 from USA and Canada

(516) 435-6250

(516) 434-9314 (Fax)

California: (7:00 AM - 5:00 PM Pacific Time)

(800) NET-LEAD (638-5323) from USA and Canada

(714) 707-5607

(714) 707-2491 (Fax)

You can use the following BBS numbers to obtain the latest Ethernet drivers from SMC:

Modem settings: 9600, 8, n, 1

California: (714) 707-2481

New York: (516) 434-3162

Germany: 49 (89) 928806-50  
France: 33 (1) 39.73.57.00  
United Kingdom: 44 (0) 932 350681

SMC also provides the drivers on their FTP site, which can be accessed at `ftp.smc.com` or through their WWW site at `www.smc.com`.

Other drivers can be obtained from Microsoft at their WWW and FTP sites: `www.microsoft.com` and `ftp.microsoft.com`.

## PCMCIA

---

The VXIpc-850 uses the 82092AA PCI to PCMCIA/Enhanced IDE Controller (PPEC) from Intel for its PCMCIA interface, providing hot swappable support for two PCMCIA devices.

The VXIpc-850 supports Type I, II, and III PCMCIA cards in its upper slot and Type I and II PCMCIA cards in its lower slot. This allows you to have a Type II and a Type III PCMCIA card in your system at the same time.

## Installing the PCMCIA Software

Perform the following steps to install the PCMCIA driver.

1. The software required for a PCMCIA interface, known as card-and-socket services, is provided by SystemSoft Corporation. National Instruments includes CardWizard to users who order the VXIpc-850 with DOS/Windows 3.1. CardWizard is a complete package of card-and-socket services with built-in diagnostic capabilities to help diagnose common PCMCIA problems. CardWorks is a Windows 95 application that supplements the PCMCIA support already in Windows 95. It also provides diagnostic services.
2. An image of the SystemSoft CardWizard or CardWorks installation disk is provided in `c:\images\pcmcia`. You run `SETUP` from that directory. Because that directory is an image of the installation disk, the setup utility actually creates a new directory for its run-time files.

The *VXIpc-850 Peripherals User Manual* contains the complete PCMCIA documentation.

## Technical Information about the PCMCIA Interface

The PPEC chip has two modes. Mode 0 supports two independent PCMCIA slots or one PCMCIA slot and two IDE interfaces (for four drives). Mode 1 supports four non-independent PCMCIA slots and two IDE interfaces.

Users who are already familiar with the Intel PPEC should note that the VXIpc-850 uses Mode 0 (via pulldown resistors on SPKROUT#/MODE and AREG#/IDECFG) to support hot insertion and removal of the PCMCIA cards. This is not possible in Mode 1 because the PCMCIA slots in that mode share signals. The insertion and removal of a card will disrupt communication with other cards in the system. The IDE interface of the PPEC is disabled in favor of the CMD0640B PCI-IDE chip described in this manual.

## SCSI

---

The VXIpc-850 uses the NCR 53C810 PCI-SCSI controller from Symbios Logic, Inc. (formerly NCR Corporation). The 53C810 is based on a SCSI I/O processor core and incorporates a PCI bus master DMA core.

## Installing the SCSI Software

To install the SCSI driver, locate an image of the NCR SDMS (SCSI Device Management System) software, which resides in `C:\images\scsi`. If you are running DOS or Windows 3.x, enter a DOS shell and type `C:\images\scsi\install` to install the driver. Refer to the SDMS software information in the *VXIpc-850 Peripherals User Manual*. Chapter 2 provides detailed installation instructions for DOS and Windows 3.x. If you are running Windows NT 3.5, you will need to add the SCSI driver in `C:\images\scsi` under Windows NT Setup. Chapter 3 describes installing the SCSI driver under Windows NT.

## Technical Information about the SCSI Interface

The 53C810 supports the SCSI-2, 8-bit bus. It supports synchronous transfer rates up to 10 MB/s, and asynchronous transfer rates up to 5 MB/s. It also includes a PCI bus master DMA device that is tightly coupled to the SCSI core and supports uninterrupted scatter/gather



memory operations. A 64-byte FIFO allows the 53C810 to support up to 16 longword bursts across the PCI interface.

SCSI signals require termination at each end of the network. The VXIpc-850 provides automatic termination networks (two TL2218 chips from Texas Instruments) that you can disable via a jumper setting; however, you should not need to do this since the VXIpc-850 should be the controller (and therefore on the end) for any SCSI network connected to it.

## **GPIB (IEEE 488.2)**

---

The VXIpc-850 uses the National Instruments TNT4882C ASIC, providing the VXIpc-850 with a full GPIB Talker/Listener/Controller functionality. This ASIC gives the VXIpc-850 complete compatibility with the National Instruments AT-GPIB/TNT. In fact, the default base address, interrupt level, and DMA level are the same on the VXIpc-850 as they are on the AT-GPIB/TNT.

Because of this compatibility, included with your VXIpc-850 kit are the same manuals usually sent with an AT-GPIB/TNT kit. They explain how to get your GPIB system up and running.

### **Base Address, DMA, and IRQ Configuration**

Although the VXIpc-850 hardware is compatible with the AT-GPIB/TNT, you do not have the option to change the base address or the DMA level of the GPIB circuitry on the VXIpc-850.

- The base I/O address is 2C0
- The DMA level is 5
- The IRQ is 11 (you can also select an IRQ of 5)

The hardware installation and configuration information in the GPIB getting started manual is not relevant to the VXIpc-850.

### **Installing the NI-488.2 Software**

Because the VXIpc-850 comes with the NI-488.2 software already installed on it, you do not need to read the software installation chapter.

The rest of the GPIB getting started, user, and function reference manuals contain information about how to configure and use your GPIB system.

# Specifications

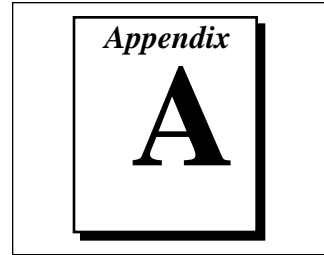

This appendix describes the environmental, electrical, and mechanical specifications of the VXIpc-850.

## Electrical

Voltage (V)	Current (A)	
	Typical	Maximum
+5	5.82 A	6.87 A
-5.2	224.5 mA	236 mA
-2	67.2 mA	95.2 mA
+12	2.26 mA	2.63 mA
-12	2.43 mA	2.43 mA

## Physical

Characteristic	Specification
Size	Two-slot VXIbus C-Size Module (233.35 by 340 by 60.96 mm)
Board Dimensions	Fully Enclosed, Shielded VXI C-Size Board 233.35 by 340 mm (9.187 by 13.386 in.)
Slot Requirements	VXI C-Size Slot
Compatibility	Fully Compatible with VXI Specification
VXI Keying Class	Class 1 TTL
MTBF	22,098 hours
Weight	2.5 Kg (5.5 lb) Typical (16 MB DRAM Installed)

## Environmental

Characteristic	Specification
Temperature	0° to 55° C Operating; -20° to 70° C Storage
Relative Humidity	0% to 95% Noncondensing, Operating; 0% to 95% Noncondensing, Storage
EMI	FCC Class A Verified, EC Verified
Vibration	Operational: 5 to 500 Hz, 0.31g, 3 axes Non-operations: 5 to 500 Hz, 2.5g, 3 axes
Functional Shock	MIL-T-28800E Class 3 (per Section 4.5.5.4.1) Half-Sine Shock Pulse (11 ms duration, 30g peak, 3 shocks per face)



**Note:** *Random vibration profiles were developed in accordance with MIL-T-28800E and MIL-STD-810E Method 514. Test levels exceed those recommended in MIL-STD-810E for Category 1 (Basic Transportation, Figures 514.4-1 through 514.4-3). Test report available upon request.*

## Requirements

Characteristic	Specification
VXIbus Configuration Space	64 B
A24 or A32 Space	16 KB Minimum (Programmable)

## Performance

VME Transfer Rate			
Peak	D32		33 MB/s
Sustained	D32	Reads	13.76 MB/s
		Writes	11.37 MB/s

## VMEbus Capability Codes

Capability Code	Description
A32, A24, A16 (master)	VMEbus master A32, A24, and A16 addressing
A32, A24, A16 (slave)	VMEbus slave A32, A24, and A16 addressing
D64, D32, D16, D08(E0) (master)	VMEbus master D64, D32, D16, and D08 data sizes
D64, D32, D16, D08(E0) (slave)	VMEbus slave D64, D32, D16, and D08 data sizes
BLT, MBLT (master)	VMEbus master block and D64 transfers
BLT, MBLT (slave)	VMEbus slave block and D64 transfers
RMW (master)	VMEbus master read/modify/write transfers
RMW (slave)	VMEbus slave read/modify/write transfers
RETRY (master)	VMEbus master retry support
RETRY (slave)	VMEbus slave retry support
FSD	First slot detector
SCON	VMEbus System Controller (Automatic Detection)
PRI, RRS	Prioritized or Round Robin Select arbiter
ROR, FAIR	Release on Request and FAIR bus requester
IH(7-1)	Interrupt handler for levels 7-1
I(7-1)	Interrupt requester for levels 7-1
D32, D16, D08(O) (Interrupt Handler)	VMEbus D32, D16, D08(O) interrupt handler
D32, D16, D08(O) (Interrupter)	VMEbus D32, D16, D08(O) interrupter
ROAK, RORA	Release on Acknowledge or Register Access interrupter
BTO(x)	VMEbus bus timer (programmable limit)
LOCK	Can lock the VMEbus for indivisible transfers

## Adding RAM

To add RAM to the VXIpc-850, remove the top cover and add SIMM modules to the two empty SIMM sockets. The maximum amount of RAM that can be added to a standard configuration of 16 MB is 64 MB, yielding a total of 80 MB. By replacing the 16 MB SIMMs, you can have a total of 128 MB.

National Instruments recommends the following types of SIMMs for use with the VXIpc-850 controllers:

8 MB: 2 MB x 36 SIMMs - 70ns

16 MB: 4 MB x 36 SIMMs - 70ns

32 MB: 8 MB x 36 SIMMs - 70ns

The height of SIMMs used with VXIpc-850 controllers should be 0.85 in. or less. Contact National Instruments for recommendations on specific manufacturers.

# VXIpc-850 System Resources

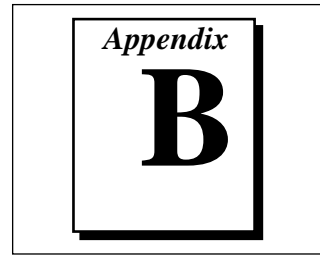

This appendix describes what systems resources are available on the VXIpc-850 and where they are allocated. Because PCI is a relatively new addition to PCs, this chapter describes how PCI interrupts fit into a PC architecture before listing the devices that use them.

## PCI Interrupts

PCI interrupts can be shared by multiple devices and are therefore more flexible than ISA interrupts. They do not actually connect to the processor directly; they are instead mapped through ISA interrupts in the system I/O module. The interrupt handler for a particular ISA interrupt must know if it will be acknowledging a PCI device.

## Resource Tables

This section provides tables describing where system resources are assigned. Table B-1 lists how the ISA interrupts are allocated on the VXIpc-850 and whether they are driven by a PCI interrupt. Table B-2 lists DMA channel allocation, and Table B-3 gives the I/O address map.

Table B-1. ISA Interrupt Resource Allocations

<b>ISA Interrupt</b>	<b>PCI Interrupt</b>	<b>Device</b>
NMI	None	Parity
0	None	Timer
1	None	Keyboard

(continues)

**Table B-1.** ISA Interrupt Resource Allocations (Continued)

<b>ISA Interrupt</b>	<b>PCI Interrupt</b>	<b>Device</b>
2	None	IRQ Expansion (8-15)
3	None	COM2
4	None	COM1
5	INTC, INTB	GPIB/PCMCIA Slot/Expansion
6	None	Floppy Drive
7	None	LPT1
8	None	RTC
9	None	Ethernet
10	INTA	VXI, SCSI, PCMCIA
11	None	GPIB/PCMCIA Slot/Expansion
12	None	Mouse
13	None	FPERR
14	INTD	IDE
15	None	PCMCIA Slot/Expansion

**Table B-2.** DMA Channel Resource Allocations

<b>DMA Channel</b>	<b>Device</b>
0	Free
1	Free
2	Floppy Drive
3	Free
4	Free
5	GPIB
6	Free
7	Free

Table B-3. I/O Address Map

I/O Address	Device	I/O Address	Device
000-00F	8237 DMA #1	2E8-2EF	COM*
020-021	8259 PIC #1	2F8-2FF	COM*
040-043	8253 Timer	300-30F	Ethernet
060-066	8742 Controller	310-36F	Free
070-077	CMOS RAM & NMI Mask Reg	370-377	Reserved
078-07B	BIOS Timer	378-37F	LPT*
080-090	DMA Page Registers	380-3B0	Free
092	Reserved	3BC-3BF	LPT*
094-09F	DMA Page Registers	3E8-3EF	COM*
0A0-0A1	8259 PIC #2	3F0-3F7	Floppy
0B2-0B3	Advanced Power Management	3F8-3FF	COM*
0C0-0DF	8237 DMA #2 (word mapped)	40A	<i>Scatter/Gather Int Status Reg</i>
0F0-0FF	Numeric Processor Error Reg	40B	<i>DMA1 Extended Mode Regs</i>
170-177	Reserved	410-41F	<i>Scatter/Gather Status</i>
1F0-1F7	IDE	420-43F	<i>Scatter/Gather Descriptor Table Pointer</i>
200-270	Free	481-488	<i>DMA High Page Regs</i>
278-27F	LPT*	4D0-4D1	<i>Interrupt Edge/Level Control Regs</i>
280-2DF	Free	4D6	<i>DMA2 Extended Mode Regs</i>
2C0-2DF	GPIO	*	Relocatable



**Note:** *I/O locations in italics indicate addresses above 1 KB. These locations are not usually accessible in an ISA-based system; however, newer PCI-based chipsets have increased the amount of I/O space available.*



# LED Indicators

---

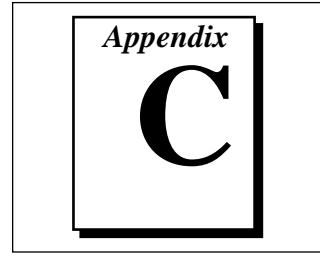

This appendix describes how to read the LEDs on the front panel to interpret the status of the VXIpc-850.

## VXIbus Interface Status LEDs

---

The VXIbus interface status LEDs are located at the top of the module and include four LEDs: FAILED, SYSFAIL, ONLINE, and TEST. They indicate the various stages of initialization that occur as the VXIpc-850 boots. The following paragraphs describe each LED.

### **SYSFAIL LED**

The SYSFAIL LED is lit when the VMEbus SYSFAIL signal is asserted. It does not necessarily indicate that the VXIpc-850 is asserting SYSFAIL, only that there is a device in the system asserting SYSFAIL.

### **FAILED LED**

The FAILED LED is lit when the VXIpc-850 is driving the SYSFAIL signal. The VXIpc-850 asserts SYSFAIL when the PASSED bit in its VXIbus status register is clear. The PASSED bit is set by the power-on self configuration circuitry (POSC) when it has completed initializing the VXIbus interface.

### **ONLINE LED**

The ONLINE LED is lit when the Resource Manager has successfully completed and the VXIbus interface is ready for application programs.

### **TEST LED**

The TEST LED is lit when the power-on self configuration circuitry is configuring the VXIbus interface.

## LEDs and System Startup Cycle

Table C-1 shows a system startup cycle and possible points of failure, up to and including the state in which VXIinit asserts the ONLINE LED.

Table C-1. LEDs and System Startup Status

Step	LEDs Lit	Status	Possible Problem if VXIpc-850 Fails
1	None	Machine just turned on.	The VXIpc-850 is not receiving power.
2	FAILED, SYSFAIL	Now asserting SYSFAIL because VXIbus interface has not been initialized yet.	Power-on self configuration (POSC) cannot execute because of problems with system reset or because the POSCEN switch is incorrectly configured.
3	FAILED, TEST	VXI interface is being initialized by MITE power-on self configuration (POSC) circuitry.	POSC has stalled.
4	TEST	POSC circuitry has initialized VXI interface, setting PASSED and DONE bits.	POSC stalled before clearing the TEST LED.
5	None	POSC cycles are complete. VXI port is ready to respond to Resource Manager inquiries.	POSC completed successfully; however, Resman either hung or was not executed.
6	ONLINE	Resman has been executed, indicating that the VXI software can now communicate with the VXI circuitry.	Resman interface initialized successfully.

If either the SYSFAIL or FAILED LED remains lit, perform the following steps:

1. Power off the mainframe.
2. Remove all other modules from the mainframe.
3. Make sure that the VXIpc-850 jumper settings are correct.
4. Make sure that the VXIpc-850 is seated properly in the mainframe.
5. Power on the mainframe and observe whether the SYSFAIL and FAILED LEDs become unlit some time before the operating system boots.

## Board Access LEDs

---

The board access LEDs, ACCESS and DRIVE, indicate when board resources have been accessed. The following paragraphs describe these LEDs.

### ACCESS LED

When lit, the ACCESS LED indicates that the VXIpc-850 MODID line is asserted or that another VXIbus master is accessing VXIbus shared registers or shared memory.

### DRIVE LED

The DRIVE LED light indicates that an access to the internal hard disk drive is occurring.

## Ethernet LEDs

---

The Ethernet LEDs (RX, TX, LINK, and DSEL) indicate the status of the Ethernet interface.

### RX LED

The RX LED lights when the Ethernet interface is receiving a packet.

### TX LED

The TX LED lights when the Ethernet interface is transmitting a packet.

### LINK LED

The LINK LED indicates LINK status and can generally be used to check if Ethernet activity is occurring.

### DSEL LED

The DSEL (Device Select) LED lights when Ethernet registers are being accessed.

# Front Panel and Connectors

---

This appendix describes the front panel and connectors on the VXIpc-850. This material contains the information relevant to VXI *plug&play* Specification VPP-8, *VXI Module/Mainframe to Receiver Interconnection*.



**Note:** *The illustrations in this appendix show the mating face of the connectors. An asterisk suffix (\*) on a signal name indicates that the signal is active low.*

## Front Panel

---

Figure D-1 shows the front panel layout of the VXIpc-850. The drawing shows dimensions relevant to key elements on the front panel. Dimensions are shown in millimeters and inches. The front panel thickness is 2.49 mm (0.098 in.).

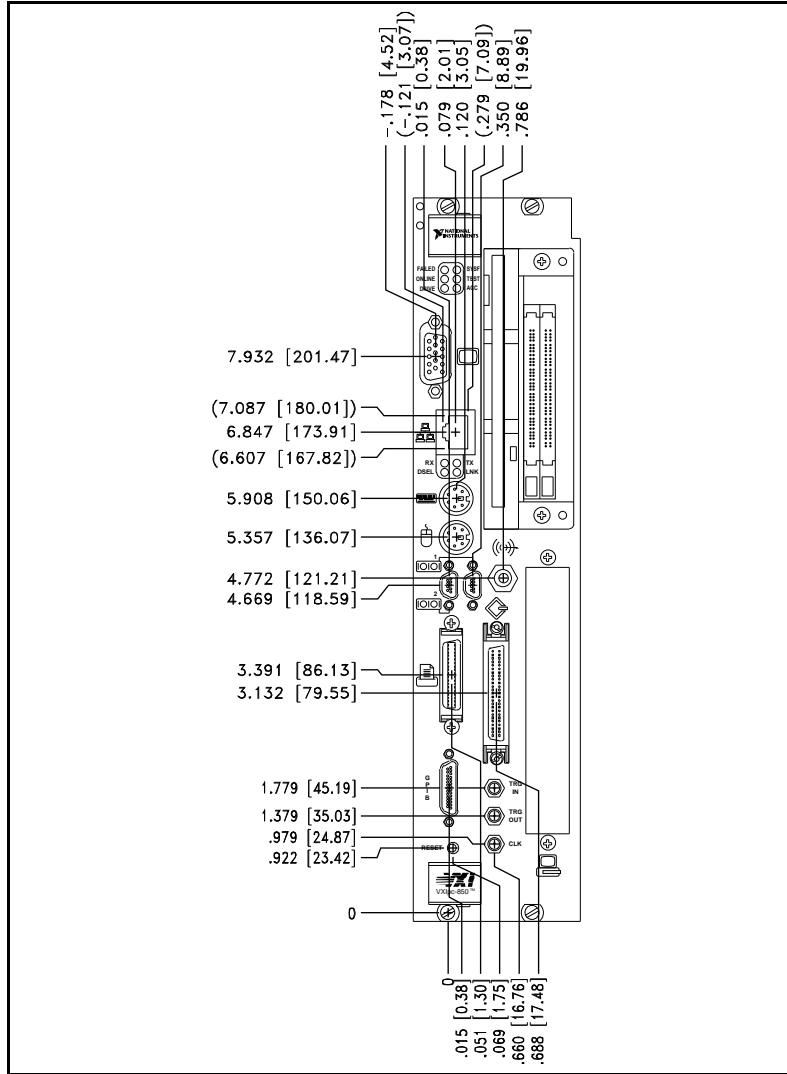

Figure D-1. VXIpc-850 Front Panel Layout and Dimensions

## Keyboard and Mouse

Figure D-2 shows the location and pinouts for the keyboard and mouse connectors on the VXIpc-850. Table D-1 gives the name and description for the keyboard and mouse connector signals.

Amp manufactures a mating connector with part numbers 212437-4 (housing), 212435-7 (ferrule), and 66735-4 (pin contact).

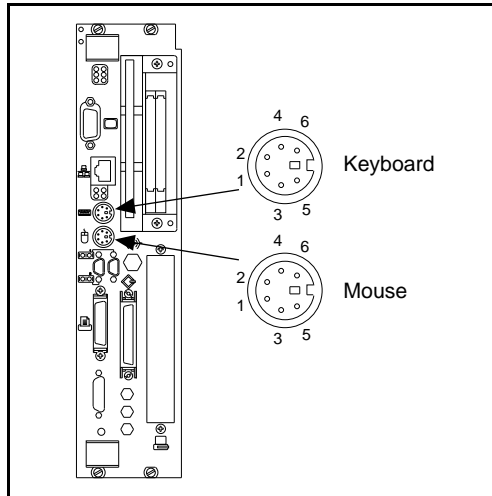

Figure D-2. Keyboard and Mouse Connectors Location and Pinout

Table D-1. Keyboard and Mouse Connector Signals

Pin	Signal Name	Signal Description
1	DATA	Data
2	NC	Not Connected
3	GND	Ground
4	+5V	+5 volts
5	CLK	Clock
6	NC	Not Connected

## VGA

---

Figure D-3 shows the location and pinouts for the VGA connector on the VXIpc-850. Table D-2 gives the name and description for the VGA connector signals.

Amp manufactures a mating connector with part numbers 748364-1 (housing) and 748333-2 (pin contact).

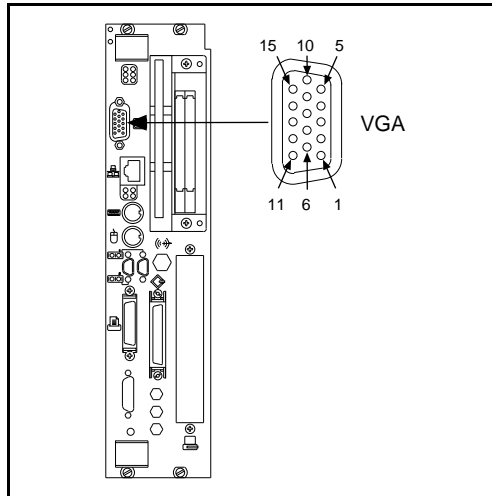

Figure D-3. VGA Connector Location and Pinout

Table D-2. VGA Connector Signals

Pin	Signal Name	Signal Description
1	R	Red
2	G	Green
3	B	Blue
4	NC	Not Connected
5	GND	Ground
6	GND	Ground
7	GND	Ground
8	GND	Ground
9	+5 VDC	+5 Volts
10	GND	Ground
11	NC	Not Connected
12	SD	Serial Data
13	HSync	Horizontal Sync
14	VSynC	Vertical Sync
15	SC	Serial Clock

# Ethernet

Figure D-4 shows the location and pinouts for the Ethernet connector on the VXIpc-850. Table D-3 gives the name and description for the Ethernet connector signals.

Amp manufactures a mating connector, part number 554739-1.

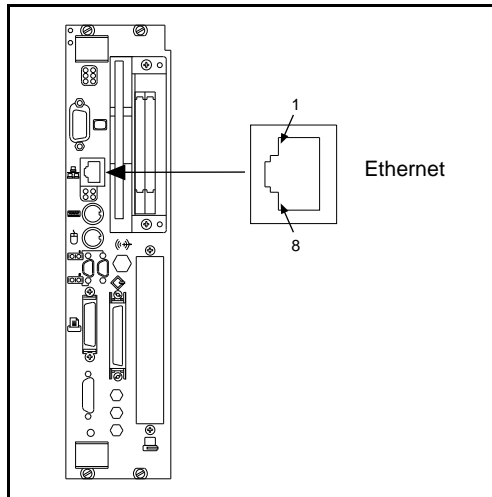

Figure D-4. Ethernet Connector Location and Pinout

Table D-3. Ethernet Connector Signals

Pin	Signal Description
1	Differential Transmit
2	Differential Transmit
3	Differential Receive
4	NC
5	NC
6	Differential Receive
7	NC
8	NC



## COM1 and COM2

Figure D-5 shows the location and pinouts for the COM1 and COM2 connectors on the VXIpc-850. Table D-4 gives the name and description for the COM1 and COM2 connector signals.

ITT Cannon manufactures a serial port mating connector, part number MDSM-9SC-Z11.

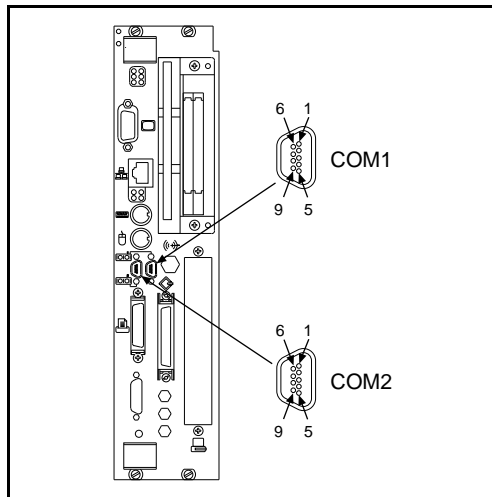

Figure D-5. COM1 and COM2 Connectors Location and Pinout

Table D-4. COM1 and COM2 Connector Signals

Pin	Signal Name	Signal Description
1	DCD*	Data Carrier Detect
2	RXD*	Receive Data
3	TXD*	Transmit Data
4	DTR*	Data Terminal Ready
5	GND	Ground
6	DSR*	Data Set Ready
7	RTS*	Ready to Send
8	CTS*	Clear to Send
9	RI*	Ring Indicator

## Parallel Port

---

Figure D-6 shows the location and pinouts for the IEEE-1284 connector on the VXIpc-850. Table D-5 gives the name and description for the IEEE-1284 connector signals.

Amp manufactures a parallel port compatible connector, part number 2-175677-5.

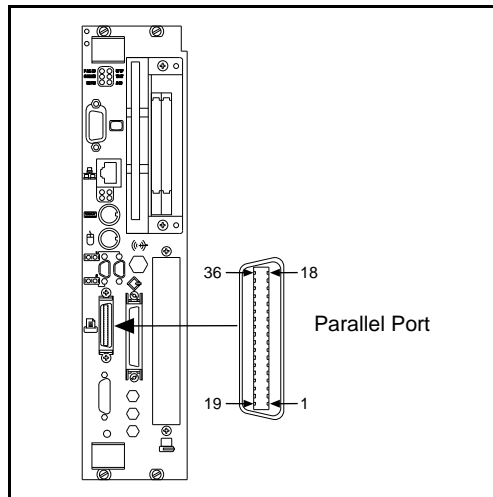

Figure D-6. Parallel Port Connector Location and Pinout

Table D-5. Parallel Port Connector Signals

Pin	Signal Name	Signal Description	Pin	Signal Name	Signal Description
1	BUSY*	Device Busy	19	GND	Ground
2	SLCTIN*	Select Input	20	GND	Ground
3	ACK*	Acknowledge	21	GND	Ground
4	FAULT*	Fault	22	GND	Ground
5	ERROR	Error	23	GND	Ground
6	PD0	Data Bit 0	24	GND	Ground
7	PD1	Data Bit 1	25	GND	Ground
8	PD2	Data Bit 2	26	GND	Ground
9	PD3	Data Bit 3	27	GND	Ground
10	PD4	Data Bit 4	28	GND	Ground
11	PD5	Data Bit 5	29	GND	Ground
12	PD6	Data Bit 6	30	GND	Ground
13	PD7	Data Bit 7	31	GND	Ground
14	INIT*	Initialize Printer	32	GND	Ground
15	STROBE*	Strobe	33	GND	Ground
16	SLCT	Select	34	GND	Ground
17	AUTOFD	Auto Line Feed	35	GND	Ground
18	+5V	+5 Volts	36	NC	Not Connected

## SCSI

---

Figure D-7 shows the location and pinouts for the SCSI connector on the VXIpc-850. Table D-6 gives the name and description for the SCSI connector signals.

Amp manufactures a SCSI compatible connector, part number 749111-4.

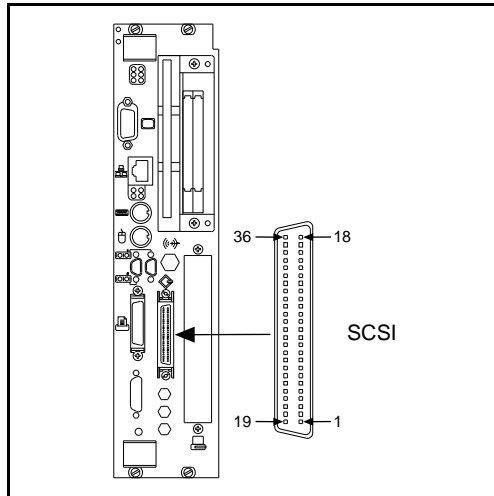

Figure D-7. SCSI Connector Location and Pinout (SCSI II)

Table D-6. SCSI Connector Signals

Pin	Signal Name	Signal Description
1–11, 15–25, 35–36, 40, 42	GND	Ground
12–14, 37–39	NC	Not Connected
26	D0	Data 0
27	D1	Data 1
28	D2	Data 2
29	D3	Data 3
30	D4	Data 4
31	D5	Data 5
32	D6	Data 6
33	D7	Data 7
34	DP	Parity
38	TERMPWR	Termination Power
41	ATN*	Attention
43	BUSY*	Busy
44	ACK*	Acknowledge
45	RESET*	Reset

(continues)

Table D-6. SCSI Connector Signals (Continued)

Pin	Signal Name	Signal Description
46	MSG*	Message
47	SEL*	Select
48	CMD_DATA	Command/Data
49	REQ*	Request
50	IN_OUT	In/Out

## GPIB (IEEE-488.2)

Figure D-8 shows the location and pinouts for the GPIB connector on the VXIpc-850. Table D-7 gives the name and description for the GPIB connector signals.

ITT Cannon manufactures a GPIB mating connector, part number MDSM-255C-Z11.

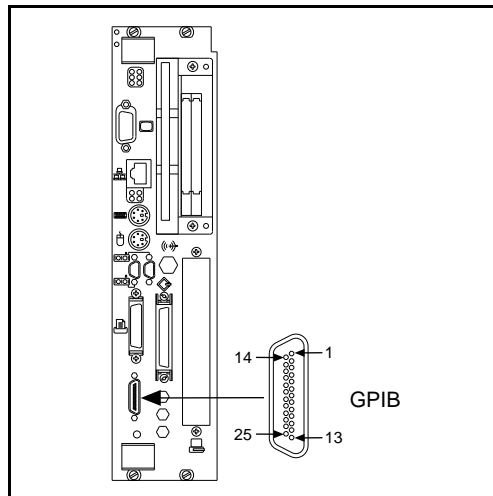

Figure D-8. GPIB Connector Location and Pinout

Table D-7. GPIB Connector Signals

Pin	Signal Name	Signal Description
1	DIO1*	Data Bit 1
2	DIO2*	Data Bit 2
3	DIO3*	Data Bit 3
4	DIO4*	Data Bit 4
5	EOI*	End or Identify
6	DAV*	Data Valid
7	NRFD*	Not Ready for Data
8	NDAC*	Not Data Accepted
9	IFC*	Interface Clear
10	SRQ*	Service Request
11	ATN*	Attention
12	SHIELD	Chassis ground
13	DIO5*	Data Bit 5
14	DIO6*	Data Bit 6
15	DIO7*	Data Bit 7
16	DIO8*	Data Bit 8
17	REN*	Remote Enable
18	GND	Logic Ground
19	GND	Logic Ground
20	GND	Logic Ground
21	GND	Logic Ground
22	GND	Logic Ground
23	GND	Logic Ground
24	GND	Logic Ground
25	GND	Logic Ground

## External SMBs

---

Figure D-9 shows the location and pinouts for the SMB connector on the VXIpc-850. Table D-8 gives the name and description for the SMB connector signals.

Amp manufactures an SMB mating connector, part number 1-413985-0.

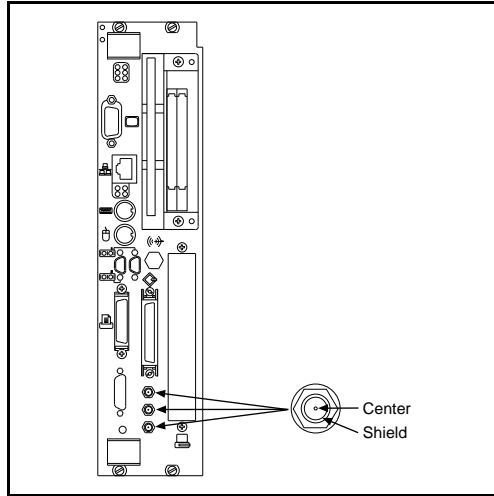

Figure D-9. SMB Connectors Location and Pinout

Table D-8. SMB Connector Signals

Pin	Signal Description
Center	TTL Trigger or Clock Signal
Shield	Ground

## VXIbus P1 and P2

Figure D-10 shows the location and pinouts for the VXIbus connector on the VXIpc-850. Table D-9 gives the name and description for the VXIbus P2 connector signals. Table D-10 gives the name and description for the VXIbus P1 connector signals.

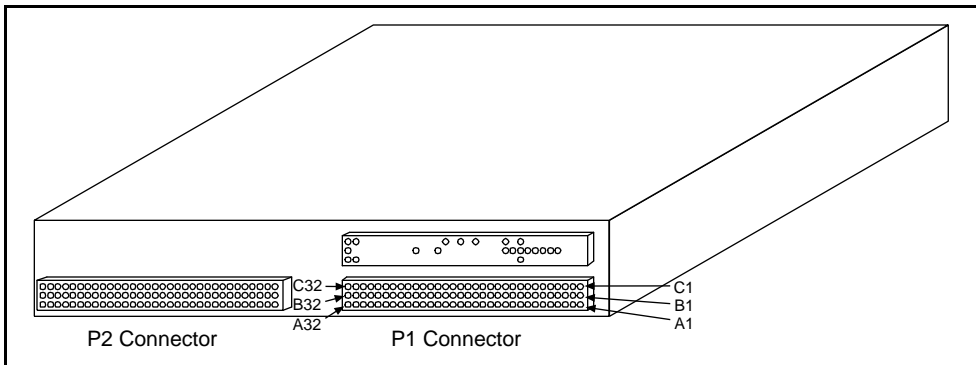

Figure D-10. VXIbus Connector's Location and Pinout

Table D-9. VXIbus P2 Connector Signals

Pin	Row C	Row B	Row A
1	CLK10+	+5 V	ECLTRG0
2	CLK10-	GND	-2 V
3	GND	Not Connected	ECLTRG1
4	-5.2 V	A24	GND
5	Not Connected	A25	MODID12
6	Not Connected	A26	MODID11
7	GND	A27	-5.2 V
8	Not Connected	A28	MODID10
9	Not Connected	A29	MODID09
10	GND	A30	GND
11	Not Connected	A31	MODID08
12	Not Connected	GND	MODID07
13	-2 V	+5 V	-5.2 V
14	Not Connected	D16	MODID06
15	Not Connected	D17	MODID05
16	GND	D18	GND
17	Not Connected	D19	MODID04
18	Not Connected	D20	MODID03
19	-5.2 V	D21	-5.2 V
20	Not Connected	D22	MODID02
21	Not Connected	D23	MODID01
22	GND	GND	GND
23	TTLTRG1*	D24	TTLTRG0*
24	TTLTRG3*	D25	TTLTRG2*
25	GND	D26	+5 V
26	TTLTRG5*	D27	TTLTRG4*
27	TTLTRG7*	D28	TTLTRG6*
28	GND	D29	GND
29	Not Connected	D30	Not Connected
30	GND	D31	MODID00
31	Not Connected	GND	GND
32	Not Connected	+5 V	Not Connected

Table D-10. VXIbus P1 Connector Signals

Pin	Row C	Row B	Row A
1	D08	BBSY*	D00
2	D09	BCLR*	D01
3	D10	ACFAIL*	D02
4	D11	BG0IN*	D03
5	D12	BG0OUT*	D04
6	D13	BG1IN*	D05
7	D14	BG1OUT*	D06
8	D15	BG2IN*	D07
9	GND	BG2OUT*	GND
10	SYSFAIL*	BG3IN*	SYSCLK
11	BERR*	BG3OUT*	GND
12	SYSRESET*	BR0*	DS1*
13	LWORD*	BR1*	DS0*
14	AM5	BR2*	WRITE*
15	A23	BR3*	GND
16	A22	AM0	DTACK*
17	A21	AM1	GND
18	A20	AM2	AS*
19	A19	AM3	GND
20	A18	GND	IACK*
21	A17	Not Connected	IACKIN*
22	A16	Not Connected	IACKOUT*
23	A15	GND	AM4
24	A14	IRQ7*	A07
25	A13	IRQ6*	A06
26	A12	IRQ5	A05
27	A11	IRQ4	A04
28	A10	IRQ3	A03
29	A09	IRQ2	A02
30	A08	IRQ1	A01
31	+12 V	Not Connected	-12 V
32	+5 V	+5 V	+5 V



# Speaker

---

Figure D-11 shows the location of the speaker connection on the VXIpc-850.

Switchcraft manufactures a mating speaker connector, part number 750.

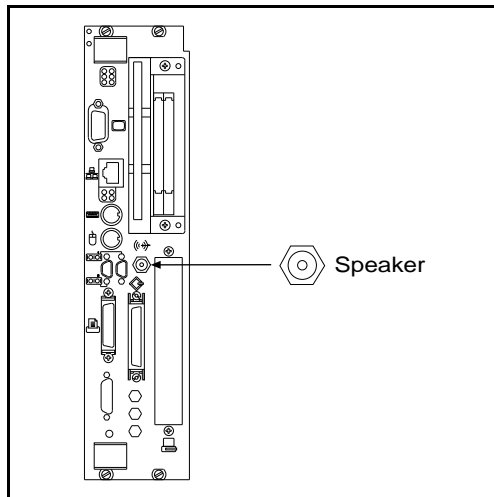

Figure D-11. Speaker Connection Location

## Signal Characteristics

---

Refer to the relevant standard for the signal characteristics for VGA, SCSI, Ethernet, keyboard, mouse, parallel, serial, and GPIB.

Table D-11 shows the signal characteristics for the SMB and speaker connections.

**Table D-11 .** Signal Characteristics for SMB and Speaker Connections

<b>Signal</b>	<b>Voltage Range</b>	<b>Maximum Current</b>	<b>Frequency Range</b>
SMB (TRIG out, CLK out)	0 to 3.4 V	200 mA	DC-10 MHz
Speaker	0 to 4.3 V	75 mA	DC-20 kHz
SMB (TRIG in)	0 to 5 V	100 mA*	DC-10 MHz

\* with 50  $\Omega$  termination

# Modifying and Installing I/O Expansion Boards

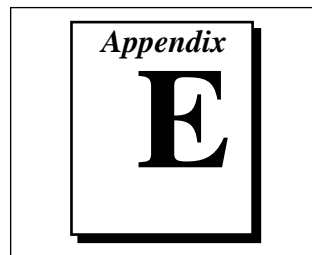

This appendix explains how to modify and install an I/O board in the VXIpc-850.

## Height of VXIpc-850 Plug-In Boards

In general, the VXIpc-850 can accommodate any standard-size PCI card and any XT-height ISA card. The height of an I/O card is measured from the bottom of the bus connector to the top of the board, as shown in Figure E-1.

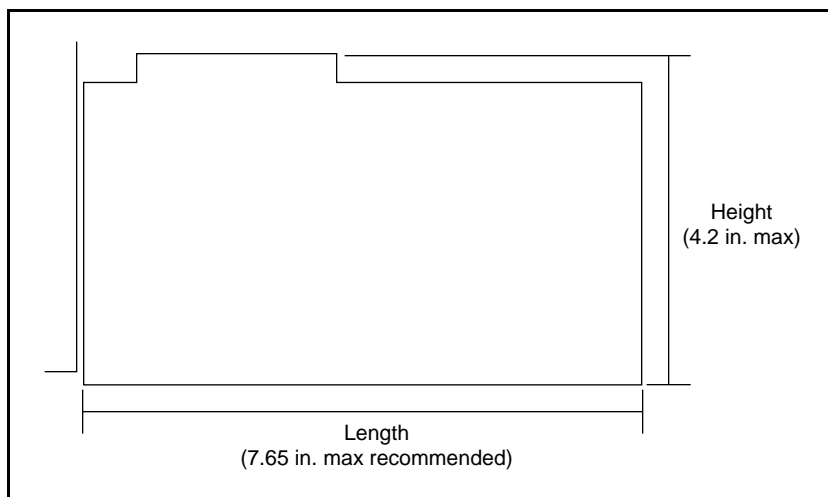

Figure E- 1. I/O Board Dimensions for VXIpc -850 Expansion Slot

Both PC height ISA cards and PCI cards are 4.2 in. high. The VXIpc-850 does not support PC-AT height ISA cards, which are 4.8 in. high.

## Length of VXIpc-850 Plug-In Boards

The VXIpc-850 will easily accommodate any PCI or ISA I/O boards that are 4.2 in. high or less and are 7.72 in. in length or less. If you want to install a longer board, you must consider several conditions such as handling, vibration, and possible contact with the system DRAM SIMMs.

When you install a plug-in board, the front end of the board that sticks out of the VXIpc-850 front panel is firmly supported, because it is screwed to the front panel of the VXIpc-850. Longer boards cannot be firmly supported away from the front panel; therefore, if your system requires rugged handling or resides in a high vibration environment, plug-in boards longer than 7.72 in. are not recommended.

The restrictions on the length of a VXIpc-850 plug-in board also depend on the possibility of physical contact with the system DRAM SIMMs. Because the DRAM SIMMs are more likely to interfere with ISA cards than PCI cards, the two are discussed separately in the following sections.

### Length of PCI Plug-In Boards

The VXIpc-850 should accommodate any standard 32-bit, 5 V PCI I/O board. The maximum standard dimensions of a PCI I/O board are 12.283 in. by 4.2 in. PCI cards are installed in the VXIpc-850 such that the board components face the processor card, which contains the processor and system RAM. Exceptionally tall PCI components on a plug-in board may physically contact the DRAM SIMMs installed on the CPU card of the VXIpc-850, as shown in Figure E-2.

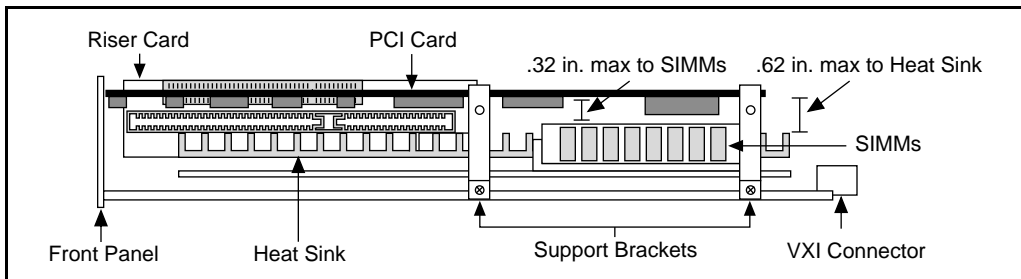

Figure E-2. Component Height Restrictions on PCI Plug-In Boards

Because larger DRAM sizes may employ taller SIMMs, you must be careful that the component height of the PCI board does not interfere with the SIMMs in such a way that electrical shorts occur or that the PCI board is stressed enough to compromise its physical or electrical integrity.

## Length of ISA Plug-In Boards

Because ISA boards mount with the components facing away from the CPU card, which contains the processor and system RAM, tall DRAM SIMMs will interfere with the circuit card of the plug-in board. Most SIMM modules are at least one inch in height and would extend into the plane of the ISA circuit card by 0.15 in. Therefore, National Instruments does not recommend the use of cards that are greater than 7.72 in. in length. They can be made to fit; however, care must be taken to ensure the following conditions:

- Contact of the board with the SIMMs should not cause electrical shorts (because of through-hole component leads on the side of the plug in board that contacts the SIMMs).
- Contact of the board with the SIMMs does not cause physical stress to the plug-in board.
- Contact of the board with the SIMMs does not cause physical stress to the riser board into which the plug in board is inserted.

Figure E-3 shows the length restrictions on ISA cards for the VXIpc-850.

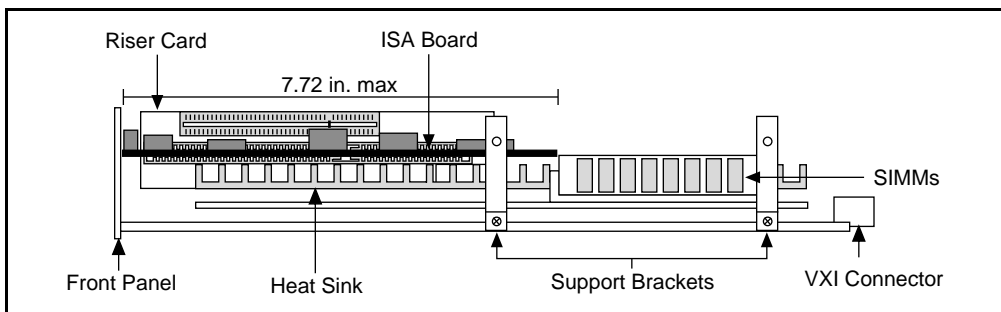

Figure E- 3. Length Restrictions on ISA Plug-In Boards

# Installing an I/O Board

---

## Materials Needed

You need the following pieces to install an expansion board in the VXIpc-850.

- User-defined panel is required on the expansion boards based on National Instruments blank PCI or ISA panels. Contact National Instruments for a list of specifications for user-defined panels.

As an alternative, you can modify the blank panels provided with the VXIpc-850. Custom panel design services are available from National Instruments for a nominal fee.

- PEM nut or a 4-40 nut with lock washer (hole diameter should be 0.125 in).
- 4-40 x 1/4 in. stainless steel panhead screw.

## Installation Steps

Follow these steps to install the expansion board.

1. Notice that the VXIpc-850 includes two card guides that can be rotated to secure the top of either a PCI or an ISA plug-in board. You may use one or both of these card guides, depending on the length of your installed board. Loosen the screw holding the guide and rotate the guide to the uppermost position for PCI boards or the lowermost position for ISA boards.
2. Replace the manufacturer-supplied panel bracket with the custom bracket. The two holes in the bracket align with existing holes in the VXIpc-850 front panel.
3. Seat the board firmly in one of the expansion bus connectors.
4. Affix the board to the front panel with the two screws. You can use a PEM nut on the back (far) side of the bracket, or a 4-40 nut with lock washer (hole diameter should be 0.125 in.). In either case, use a 4-40 x 1/4 in. stainless steel panhead screw to mount the board/bracket assembly to the front panel.

Figure E-4 shows a PCI board installed in the VXIpc-850.

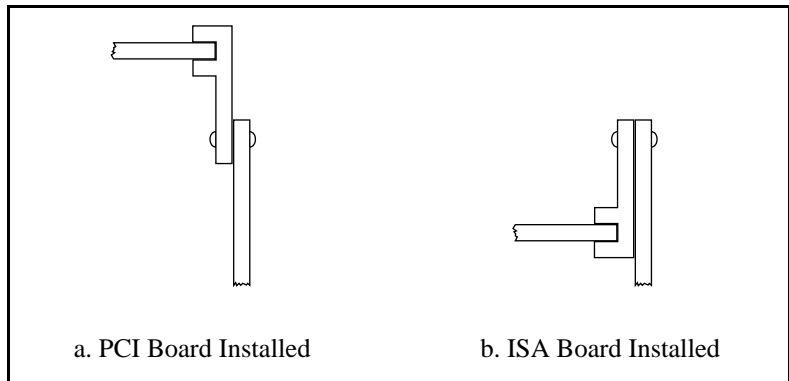

Figure E- 4. PCI Board Installed in a VXIpc -850

# Common Questions

---

This appendix answers common questions you may have when using the VXIpc-850.

## **What do the LEDs on the front of the VXIpc-850 mean?**

Refer to Appendix C, *LED Indicators*, for a description of the front panel LEDs.

## **Is something wrong with the VXIpc-850 if the red SYSFAIL and FAILED LEDs stay lit after booting the VXIpc-850?**

If either the SYSFAIL or FAILED LED remains lit, refer to Appendix C, *LED Indicators*, for troubleshooting steps.

## **Can I access 32-bit registers in my VXIbus system from the VXIpc-850?**

Yes. The VXIpc-850 uses the 32-bit PCI bus to interface to the VXIbus. In fact, the VXIbus circuitry on the VXIpc-850 also supports the new VME64 standard for D64 accesses. Refer to your VXI software manual for more information.

## **What kind of signal is CLK10 and what kind of signal do I need for an external CLK10?**

CLK10 is a differential ECL signal on the backplane. However, the oscillator for the VXIpc-850 and the EXTCLK input from the front panel use TTL levels; therefore, you need to supply a TTL-level signal for EXTCLK. Our voltage converters convert the signal to differential ECL.

## **What is the accuracy of the CLK10 signal?**

The CLK10 signal generated by the VXIpc-850 is  $\pm 100$  ppm (0.01%) as per the VXIbus specification. If you need a more accurate CLK10 signal, you can use the EXTCLK input at the front of the VXIpc-850.



**If I boot the computer without video, and then plug in the video, why is it in black and white?**

When the computer first boots, the video chips try to synchronize with the monitor. If the monitor is not there, the video chips cannot synchronize and establish color. You need to have the monitor attached at boot time to get color.

**I've installed the SCSI software. Why doesn't the VXIpc-850 recognize my SCSI device?**

This problem usually occurs when SCSI has not been enabled in the BIOS. Enter your BIOS by pressing <DEL> at boot time. In the **Setup** window, click on the **Chipset** icon. Select the **On Board PCI SCSI** option and enable it.

**What type of video interface is onboard the VXIpc-850? What video drivers are included with the VXIpc-850? Can I use Super VGA with my VXIpc-850? If my application requires a special type of video display, how do I configure my VXIpc 850?**

The VXIpc-850 uses the Trident Microsystems TGUI96xx chip family, a combination graphics accelerator and RAMDAC. The TGUI9660 is the first chip from this family used. Succeeding pin-compatible chips will follow. The chips in this family are compatible with the Standard VGA video output MS Windows video driver, as well as the Trident Microsystems video driver. For information on the Trident driver, refer to the *VXIpc-850 Peripherals User Manual*.

If your application requires a special type of video display, you can remove the PCI video card included with your VXIpc-850. Contact National Instruments for information on how to do this.

**What kind of monitor can I use with the VXIpc-850?**

VXIpc-850 computers that use Super VGA video output will work only with monitors having a horizontal scan rate of at least 50 kHz and a vertical scan rate of 60 Hz.



**Warning:** *Make sure that your monitor meets this specification. Enabling the Super VGA option on a monitor that does not meet this specification will cause damage to your monitor.*

**What if my keyboard connector does not fit into the keyboard port on the VXIpc-850?**

You can plug keyboards that have a 6-pin Mini DIN PS/2 type connector directly into the VXIpc-850. You can use the keyboard adapter cable that is included with every VXIpc-850 kit to adapt the larger AT keyboard connector to the 6-pin Mini DIN connector.

**How do I connect an external speaker to the VXIpc-850 to get audio capability?**

A twisted-pair cable connects the front panel audio connector to the VXIpc-850 motherboard. Connect the external speaker to this front-panel connector. The center pin of the connector provides the audio signal. The shield of the connector is GROUND.

**How do I add RAM to the VXIpc-850? What is the maximum amount of RAM that I can have on the VXIpc-850?**

For information about adding RAM to the VXIpc-850, refer to Appendix A, *Specifications*.

**Which interrupt levels are free to be used by ISA bus boards? Which area of upper memory (adapter space) is free for use by ISA bus boards or expanded memory manager software programs?**

See Appendix B, *VXIpc-850 System Resources*, for information on the available port I/O register space, upper memory area, interrupts, and DMA channels.

**How do I install the VXIpc-850 in a slot other than Slot 0?**

The VXIpc-850 automatically detects whether or not it is in Slot 0 of a VXIbus mainframe. You do not need to change jumper settings to install the VXIpc-850 in a slot other than Slot 0 unless you have defeated the first slot detector (FSD) circuitry by changing jumper W13.

Refer to Chapter 3 of this manual, *Configuration and Installation*, for information on enabling and defeating the FSD circuitry.

**How do I check the configuration of the memory, floppy drive, hard drive, time/date, and so on?**

You can view these parameters in the BIOS setup. To enter the BIOS setup, reboot the VXIpc-850 and press the < DEL > key during the memory tests. Refer to Chapter 4, *WinBIOS*, for more information.

### **How do I disable the automatic memory check when booting the VXIpc-850?**

Though the BIOS will always check memory below 1 MB, you can disable it from checking for memory above 1 MB. To change the BIOS, enter the setup by pressing <DEL> as the system is booting and select the *Advanced* icon in the *Setup* window. Disable the *Above 1 M Memory Test*, save your settings, and reboot the system.

### **Can I upgrade my VXIpc-850?**

You can upgrade the modular CPU card to upgrade the processor. Contact National Instruments for information.

### **What should I do if I cannot boot from the hard disk ?**

Make sure the IDE block is set to Auto, LBA is enabled, and 32-bit disk access is disabled.

### **Why does my computer hang on CSALLOC when I install the PCMCIA Card Wizard?**

CSALLOC hangs unless the serial ports are set to 3E8 and 2E8.

### **How can I boot from an external SCSI hard drive ?**

In the Setup/Standard window change the Master drive setting from User to SCSI, and make sure the SCSI is enabled in the Setup/Chipset window.

### **Can I use the internal IDE drive and an external SCSI hard drive at the same time?**

Yes, but you can only boot from the internal IDE drive in this configuration.

### **My CMOS is corrupted. How do I set it back to default?**

1. Select Default/Optimal.
2. Make sure floppy A is set to 1.44 in the Setup/Standard.
3. In the Setup/Advanced enable AutoBlock IDE, enable LBA mode, and disable 32-bit disk access.
4. In Setup/Peripheral change the programming mode to manual, enable FDC, set Serial Port 1 to 3E8, and set Serial Port 2 to 2E8.
5. Run Utility/Detect Master to find the hard disk.

# Customer Communication

---

For your convenience, this appendix contains forms to help you gather the information necessary to help us solve technical problems you might have as well as a form you can use to comment on the product documentation. Filling out a copy of the *Technical Support Form* before contacting National Instruments helps us help you better and faster.

National Instruments provides comprehensive technical assistance around the world. In the U.S. and Canada, applications engineers are available Monday through Friday from 8:00 a.m. to 6:00 p.m. (central time). In other countries, contact the nearest branch office. You may fax questions to us at any time.

## Electronic Services



### Bulletin Board Support

National Instruments has BBS and FTP sites dedicated for 24-hour support with a collection of files and documents to answer most common customer questions. From these sites, you can also download the latest instrument drivers, updates, and example programs. For recorded instructions on how to use the bulletin board and FTP services and for BBS automated information, call (512) 795-6990. You can access these services at:

United States: (512) 794-5422 or (800) 327-3077

Up to 14,400 baud, 8 data bits, 1 stop bit, no parity

United Kingdom: 01635 551422

Up to 9,600 baud, 8 data bits, 1 stop bit, no parity

France: 1 48 65 15 59

Up to 9,600 baud, 8 data bits, 1 stop bit, no parity



### FTP Support

To access our FTP site, log on to our Internet host, `ftp.natinst.com`, as anonymous and use your Internet address, such as `joesmith@anywhere.com`, as your password. The support files and documents are located in the `/support` directories.



## FaxBack Support

FaxBack is a 24-hour information retrieval system containing a library of documents on a wide range of technical information. You can access FaxBack from a touch-tone telephone at the following numbers: (512) 418-1111 or (800) 329-7177



## E-Mail Support (currently U.S. only)

You can submit technical support questions to the appropriate applications engineering team through e-mail at the Internet addresses listed below. Remember to include your name, address, and phone number so we can contact you with solutions and suggestions.

GPIB:	gpib.support@natinst.com
DAQ:	daq.support@natinst.com
VXI:	vxi.support@natinst.com
LabVIEW:	lv.support@natinst.com
LabWindows:	lw.support@natinst.com
HiQ:	hiq.support@natinst.com
VISA:	visa.support@natinst.com

## Fax and Telephone Support

National Instruments has branch offices all over the world. Use the list below to find the technical support number for your country. If there is no National Instruments office in your country, contact the source from which you purchased your software to obtain support.



### Telephone



### Fax

Australia	03 9 879 9422	03 9 879 9179
Austria	0662 45 79 90 0	0662 45 79 90 19
Belgium	02 757 00 20	02 757 03 11
Canada (Ontario)	519 622 9310	
Canada (Quebec)	514 694 8521	514 694 4399
Denmark	45 76 26 00	45 76 26 02
Finland	90 527 2321	90 502 2930
France	1 48 14 24 24	1 48 14 24 14
Germany	089 741 31 30	089 714 60 35
Hong Kong	2645 3186	2686 8505
Italy	02 413091	02 41309215
Japan	03 5472 2970	03 5472 2977
Korea	02 596 7456	02 596 7455
Mexico	95 800 010 0793	5 520 3282
Netherlands	0348 433466	0348 430673
Norway	32 84 84 00	32 84 86 00
Singapore	2265886	2265887
Spain	91 640 0085	91 640 0533
Sweden	08 730 49 70	08 730 43 70
Switzerland	056 200 51 51	056 200 51 55
Taiwan	02 377 1200	02 737 4644
U.K.	01635 523545	01635 523154

# Technical Support Form

Photocopy this form and update it each time you make changes to your software or hardware, and use the completed copy of this form as a reference for your current configuration. Completing this form accurately before contacting National Instruments for technical support helps our applications engineers answer your questions more efficiently.

If you are using any National Instruments hardware or software products related to this problem, include the configuration forms from their user manuals. Include additional pages if necessary.

Name \_\_\_\_\_

Company \_\_\_\_\_

Address \_\_\_\_\_

\_\_\_\_\_

Fax (\_\_\_\_) \_\_\_\_\_ Phone (\_\_\_\_) \_\_\_\_\_

Computer brand \_\_\_\_\_ Model \_\_\_\_\_ Processor \_\_\_\_\_

Operating system (include version number) \_\_\_\_\_

Clock Speed \_\_\_\_\_MHz RAM \_\_\_\_\_MB Display adapter \_\_\_\_\_

Mouse \_\_\_\_\_yes \_\_\_\_\_no Other adapters installed \_\_\_\_\_

Hard disk capacity \_\_\_\_\_MB Brand \_\_\_\_\_

Instruments used \_\_\_\_\_

National Instruments hardware product model \_\_\_\_\_ Revision \_\_\_\_\_

Configuration \_\_\_\_\_

National Instruments software product \_\_\_\_\_ Version \_\_\_\_\_

Configuration \_\_\_\_\_

The problem is \_\_\_\_\_

\_\_\_\_\_

\_\_\_\_\_

\_\_\_\_\_

List any error messages \_\_\_\_\_

\_\_\_\_\_

\_\_\_\_\_

\_\_\_\_\_

The following steps will reproduce the problem \_\_\_\_\_

\_\_\_\_\_

\_\_\_\_\_

# Hardware and Software Configuration Form

Record the settings and revisions of your hardware and software on the line to the right of each item. Complete a new copy of this form each time you revise your software or hardware configuration, and use this form as a reference for your current configuration. Completing this form accurately before contacting National Instruments for technical support helps our applications engineers answer your questions more efficiently.

## National Instruments Products

### VXIpc-850 Hardware Settings

VXIpc-850 Part Number \_\_\_\_\_

VXIpc-850 Serial Number \_\_\_\_\_

Processor Speed \_\_\_\_\_

DRAM SIMMs Installed \_\_\_\_\_

Hard Drive Size \_\_\_\_\_ Video Memory \_\_\_\_\_

Slot Location \_\_\_\_\_

W1 Setting: SCSI Termination \_\_\_\_\_

W2 Setting: CMOS \_\_\_\_\_

W4 Setting: LPT1 DMA \_\_\_\_\_

W13 Setting: Slot 0 Detection \_\_\_\_\_

S1 Setting: Ethernet EEPROM \_\_\_\_\_

S2 Setting: MITE Self-Configuration \_\_\_\_\_

S3 Setting: CLK10 Source \_\_\_\_\_

S4 Setting: Inverted/Non-inverted CLK10 Output \_\_\_\_\_

S5 Setting: CLK10 SMB \_\_\_\_\_

S6 Setting: CLK10 Input Termination \_\_\_\_\_

S7 Setting: External Trigger Input Termination \_\_\_\_\_

S8 Setting: GPIB IRQ Level \_\_\_\_\_

S9 Setting: MITE User/Factory Configuration \_\_\_\_\_

## NI-VXI Software Settings

NI-VXI Software Version Number \_\_\_\_\_

Using VXIedit or VXIedit? \_\_\_\_\_

Logical Address \_\_\_\_\_

Device Type \_\_\_\_\_

Address Space \_\_\_\_\_

VXI Shared RAM Size \_\_\_\_\_

Shared RAM Pool (Windows) \_\_\_\_\_

Byte Order for Lower Half Window \_\_\_\_\_

Byte Order for Upper Half Window \_\_\_\_\_

Mapping Scheme for Lower and Upper Half Windows of VXI Shared RAM \_\_\_\_\_

Resource Manager Delay \_\_\_\_\_

Number of Handlers \_\_\_\_\_

Number of Interrupters \_\_\_\_\_

Servant Area Size \_\_\_\_\_

Protocol Register \_\_\_\_\_

Read Protocol Response \_\_\_\_\_

System IRQ Level \_\_\_\_\_

VXI Bus Timeout \_\_\_\_\_

Arbiter Type \_\_\_\_\_

Arbiter Timeout \_\_\_\_\_

Fair Request \_\_\_\_\_

Request Level \_\_\_\_\_

A24/A32 Slave Write Post \_\_\_\_\_

VXI Retry Protocol \_\_\_\_\_



VXI Slave Auto Retry \_\_\_\_\_

VXI Transfer Limit \_\_\_\_\_

User Window Base \_\_\_\_\_

User Window Size \_\_\_\_\_

User Window Below 1 MB \_\_\_\_\_

Driver Window Base \_\_\_\_\_

Driver Window Size \_\_\_\_\_

Driver Window Below 1 MB \_\_\_\_\_

## Other Products

Mainframe Make and Model \_\_\_\_\_

Microprocessor \_\_\_\_\_

Clock Frequency \_\_\_\_\_

Type of Video Board Installed \_\_\_\_\_

Operating System \_\_\_\_\_

Operating System Version \_\_\_\_\_

Operating System Mode \_\_\_\_\_

Programming Language \_\_\_\_\_

Programming Language Version \_\_\_\_\_

Other Boards in System \_\_\_\_\_

Monitor (Manufacturer, Model) \_\_\_\_\_

Mouse (Manufacturer, Model) \_\_\_\_\_

Keyboard (Manufacturer, Model) \_\_\_\_\_

Other Peripherals (Manufacturer, Model) \_\_\_\_\_

\_\_\_\_\_

\_\_\_\_\_

\_\_\_\_\_

\_\_\_\_\_

# Documentation Comment Form

National Instruments encourages you to comment on the documentation supplied with our products. This information helps us provide quality products to meet your needs.

**Title:** VXIpc™-850 Series User Manual

**Edition Date:** April 1996

**Part Number:** 321124A-01

Please comment on the completeness, clarity, and organization of the manual.

---

---

---

---

---

---

---

---

If you find errors in the manual, please record the page numbers and describe the errors.

---

---

---

---

---

---

---

---

Thank you for your help.

Name \_\_\_\_\_

Title \_\_\_\_\_

Company \_\_\_\_\_

Address \_\_\_\_\_

---

Phone ( \_\_\_\_\_ ) \_\_\_\_\_

**Mail to:** Technical Publications  
National Instruments Corporation  
6504 Bridge Point Parkway  
Austin, TX 78730-5039

**Fax to:** Technical Publications  
National Instruments Corporation  
(512) 794-5678

# Glossary

---

Prefix	Meaning	Value
n-	nano-	$10^{-9}$
$\mu$ -	micro-	$10^{-6}$
m-	milli-	$10^{-3}$
k-	kilo-	$10^3$
M	mega-	$10^6$
G-	giga-	$10^9$

## A

A	Amperes
address	Character code that identifies a specific location (or series of locations) in memory
address space	A set of $2^n$ memory locations differentiated from other such sets in VXI/VMEbus systems by six addressing lines known as address modifiers. $n$ is the number of address lines required to uniquely specify a byte location in a given space. Valid numbers for $n$ are 16, 24, and 32. In VME/VXI, because there are six address modifiers, there are 64 possible address spaces.
ANSI	American National Standards Institute

## B

b bits

B bytes

backplane An assembly, typically a printed circuit board, with 96-pin connectors and signal paths that bus the connector pins. A C-size VXIbus system will have two sets of bused connectors called J1 and J2. A D-size VXIbus system will have three sets of bused connectors called J1, J2, and J3.

BIOS Basic Input/Output System. BIOS functions are the fundamental level of any PC or compatible computer. BIOS functions embody the basic operations needed for successful use of the computer's hardware resources.

## C

CLK10 A 10 MHz,  $\pm 100$  ppm, individually buffered (to each module slot), differential ECL system clock that is sourced from Slot 0 of a VXIbus mainframe and distributed to Slots 1 through 12 on P2. It is distributed to each slot as a single-source, single-destination signal with a matched delay of under 8 ns.

CMOS Complementary Metal Oxide Semiconductor; a process used in making chips

## D

DIN Deutsches Institut für Normung—German Standards Institute

DMA Direct Memory Access; a method by which data is transferred between devices and internal memory without intervention of the central processing unit

DRAM Dynamic RAM (Random Access Memory); storage that the computer must refresh at frequent intervals

**E**

ECL	Emitter-Coupled Logic
EDO	Extended Data Out; a DRAM architecture that shortens overall access latency, improving performance
EEPROM	Electrically Erasable Programmable Read Only Memory
embedded controller	An intelligent CPU (controller) interface plugged directly into the VXI backplane, giving it direct access to the VXIbus. It must have all of its required VXI interface capabilities built in.
EMC	Electromagnetic Compliance

**F**

fair requester	A VXIbus device that will not arbitrate for the VXIbus after releasing it until it detects the bus request signal inactive. This ensures that all requesting devices will be granted use of the bus.
FPERR	Floating Point Error

**G**

GPIB	General Purpose Interface Bus (IEEE 488)
------	------------------------------------------

**H**

hex	hexadecimal; the numbering system with base 16, using the digits 0 to 9 and letters A to F
Hz	hertz; cycles per second

**I**

IDE	Integrated Drive Electronics. Denotes the most common interface to the hard drive on PCs.
IEEE	Institute of Electrical and Electronics Engineers

## *Glossary*

in.	inches
I/O	input/output; the techniques, media, and devices used to achieve communication between machines and users
INT	interrupt
INTA	PCI interrupt A
INTB	PCI interrupt B
INTC	PCI interrupt C
INTD	PCI interrupt D
interrupt	A means for a device to request service from another device
interrupt handler	A VMEbus functional module that detects interrupt requests generated by interrupters and responds to those requests by requesting status and identify information
interrupt level	The relative priority at which a device can interrupt
IRQ*	Interrupt signal
ISA	Industry Standard Architecture denotes a common expansion bus used in PCs
<b>K</b>	
KB	kilobytes of memory
<b>L</b>	
LED	Light-emitting diode
<b>M</b>	
m	meters
master	A functional part of a VME/VXibus device that initiates data transfers on the backplane. A transfer can be either a read or a write.

MB	megabytes of memory
MITE	A National Instruments custom ASIC, a sophisticated dual-channel DMA controller that incorporates the Synchronous MXI and VME64 protocols to achieve high-performance block transfer rates
MODID	Module ID Lines. Used in VXI to geographically locate boards and to dynamically configure boards
MTBF	Mean Time Between Failure
<b>N</b>	
NI-VXI	The National Instruments bus interface software for VME/VXIbus systems
NMI	NonMaskable Interrupt
Non-Slot 0 device	A device configured for installation in any slot in a VXIbus mainframe other than Slot 0. Installing such a device into Slot 0 can damage the device, the VXIbus backplane, or both.
<b>P</b>	
PCI	Peripheral Component Interconnect. The PCI bus is a high-performance 32-bit or 64-bit bus with multiplexed address and data lines.
PCMCIA	Personal Computer Memory Card International Association
PEM	Penn Engineering Manufacturing Corporation. A manufacturer of nuts pressed into metal
POSC	Power-On Self Configuration. A process by which the MITE chip programs its own registers from EEPROMs at power up
PWB	Printed Wire Board

## R

**Resource Manager** A message-based Commander located at Logical Address 0, which provides configuration management services such as address map configuration, Commander and Servant mappings, and self-test and diagnostic management

## S

**s** seconds

**SCSI** Small Computer System Interface

**SIMM** Single In-line Memory Module

**slave** A functional part of a VME/VXibus device that detects data transfer cycles initiated by a VMEbus master and responds to the transfers when the address specifies one of the device's registers

**Slot 0 device** A device configured for installation in Slot 0 of a VXibus mainframe. This device is unique in the VXibus system in that it performs the VMEbus System Controller functions, including clock sourcing and arbitration for data transfers across the backplane. Installing such a device into any other slot can damage the device, the VXibus backplane, or both.

## T

**trigger** Either TTL or ECL lines used for intermodule communication

**TTL** Transistor-Transistor Logic

## V

**V** Volts

**VME** Versa Module Eurocard or IEEE 1014



VMEbus System Controller	A device configured for installation in Slot 0 of a VXIbus mainframe or Slot 1 of a VMEbus chassis. This device is unique in the VMEbus system in that it performs the VMEbus System Controller functions, including clock sourcing and arbitration for data transfers across the backplane. Installing such a device into any other slot can damage the device, the VMEbus/VXIbus backplane, or both.
VXIbus	VMEbus Extensions for Instrumentation
VXIinit	A program in the NI-VXI bus interface software package that initializes the board interrupts, shared RAM, VXI register configurations, and bus configurations

## **A**

ACCESS LED, 1-5, C-3  
audio capability. *See* speaker.

## **B**

base address configuration, GPIB, 5-10  
BIOS. *See also* CMOS.  
    clearing CMOS contents, 3-10  
    disabling memory checks, F-4  
    setting up. *See* WinBIOS.  
    viewing settings, F-3  
board access LEDs, C-3  
bulletin board support, G-1

## **C**

CLK10 signal, VXIbus  
    accuracy, F-1  
    definition, F-1  
    routing, 3-5 to 3-7  
        selecting signal source (figure), 3-6  
        SMB CLK10 direction (figure), 3-6  
        SMB CLK10 polarity (figure), 3-7  
        SMB CLK10 termination  
            (figure), 3-7  
CMOS. *See also* BIOS.  
    PC configuration, 3-10 to 3-11  
    setting back to default, F-4  
COM1 and COM2 connectors and  
    signals, D-6  
common questions about VXIpc-850,  
    F-1 to F-4

configuration. *See also* WinBIOS.  
    default settings, 3-1 to 3-3  
    factory default settings (table), 3-3  
    parts locator diagram, 3-2  
EEPROM, 3-8 to 3-9  
    fixing invalid configuration, 3-9  
    power-on self configuration status  
        (figure), 3-8  
    protecting against electrical hazards  
        (warning), 3-9  
    SMB trigger input termination  
        (figure), 3-8  
electrostatic discharge (warning), 3-1  
installed system RAM, 3-9  
installing VXIpc-850, 3-12 to 3-13  
PC configuration, 3-9 to 3-11  
    Ethernet power-on defaults, 3-11  
    GPIB interrupt level, 3-10  
    parallel port DMA level, 3-11  
    SCSI termination, 3-10  
    system CMOS, 3-10 to 3-11  
removing metal enclosure, 3-4  
trigger input termination, 3-7  
VXIbus CLK10 routing, 3-5 to 3-7  
VXIbus Slot 0/non-Slot 0, 3-4 to 3-5  
connectors  
    COM1 and COM2, D-6  
    Ethernet, D-5  
    external SMBs, D-11 to D-12  
    GPIB (IEEE-488.2), D-10 to D-11  
    keyboard and mouse, D-2 to D-3  
    parallel port, D-7 to D-8  
    SCSI, D-8 to D-10  
    signal characteristics, D-15  
    speaker, D-14

VGA, D-3 to D-4  
 VXIbus P1 and P2, D-12 to D-13  
 custom application-specific interface chips,  
 1-4 to 1-5  
 customer communication, *xiv*, G-1 to G-2

## D

default settings, 3-1 to 3-3  
     factory default settings (table), 3-3  
     parts locator diagram, 3-2  
 disk drives. *See* IDE controller;  
     SCSI interface.  
 DMA channel  
     GPIB configuration, 5-10  
     level for parallel port, PC  
     configuration, 3-11  
     resource allocations (table), B-2  
 documentation  
     conventions used in manual, *xii-xiii*  
     how to use documentation set, *xiii*  
     organization of manual, *xi-xii*  
     related documentation, *xiv*  
 DRIVE LED, 1-5, C-3  
 drivers for peripherals  
     installing, 5-2  
     memory requirements, 5-2  
 DSEL LED, 1-6, C-3

## E

EEPROM configuration, 3-8 to 3-9  
     fixing invalid configuration, 3-9  
     power-on self configuration status  
     (figure), 3-8  
     protecting against electrical hazards  
     (warning), 3-9  
     SMB trigger input termination  
     (figure), 3-8  
 electrical specifications, A-1  
 electronic technical support, G-1 to G-2  
 e-mail support, G-2  
 environmental specifications, A-2  
 equipment, optional, 1-2

## Ethernet

configuring addresses, 5-6  
     default settings (table), 5-6  
 connector and signals, D-5  
 interface technical information, 5-7  
 LEDs for port status, 1-6, C-3  
 power-on defaults,  
     PC configuration, 3-11  
     software installation, 5-6 to 5-7  
     technical support, 5-7 to 5-8  
 expansion boards. *See* I/O expansion boards.

## F

FAILED LED, 1-5, C-1  
 fax and telephone support, G-2  
 faxback support, G-2  
 front panel. *See also* connectors; LEDs on  
     front panel.  
     features, 1-5 to 1-6  
     layout and dimensions (figure), D-2  
 FTP support, G-1

## G

GPIB (IEEE 488.2)  
     base address, DMA, and IRQ  
     configuration, 5-10  
     connectors and signals, D-10 to D-11  
     PC configuration interrupt level, 3-10  
     software installation, 5-10

## H

hard disk. *See* IDE controller;  
     SCSI interface.

## I

IDE controller  
     interface technical information, 5-5  
     problems with booting hard disk, F-4  
     software installation, 5-4 to 5-5  
     using internal IDE drive and external  
     SCSI hard drive, F-4

installation. *See also* configuration.  
 electrostatic discharge (warning),  
 3-1, 3-12  
 I/O expansion boards, E-4 to E-5  
 peripheral drivers, 5-2  
 Slot 0 detection (warning), 3-12  
 VXIpc-850 installation procedure,  
 3-12 to 3-13

## interrupts

GPIB interrupt level  
 GPIB configuration, 5-10  
 PC configuration, 3-10  
 ISA interrupt resource allocations  
 (table), B-1 to B-2  
 PCI, B-1

I/O address map (table), B-3

I/O expansion boards

installation  
 materials needed, E-4  
 procedure, E-4 to E-5  
 VXIpc-850 plug-in boards  
 height, E-1  
 length  
 ISA boards, E-3  
 PCI boards, E-2 to E-3

ISA interrupt resource allocations (table),  
 B-1 to B-2

## J

jumper settings, 3-3. *See also* configuration.

## K

keyboard connector  
 illustration, D-2  
 problems with plugging in  
 keyboards, F-3  
 signals (table), D-2

## L

LabVIEW software, 1-3  
 LabWindows/CVI software, 1-3  
 LEDs on front panel  
 board access LEDs, C-3  
 Ethernet LEDs, 1-6, C-3  
 system startup cycle, C-2  
 VXIbus interface status LEDs,  
 1-5, C-1  
 LINK LED, 1-6, C-3

## M

MANTIS custom ASIC, 1-4  
 manual. *See* documentation.  
 memory. *See* RAM.  
 MITE custom ASIC, 1-4  
 monitor. *See also* video accelerator.  
 booting for color, F-2  
 type to use with VXIpc-850, F-2  
 mouse connector, D-2 to D-3

## N

NI-488.2 software kit, 1-2 to 1-3  
 NI-VXI bus software, 1-2

## O

ONLINE LED, 1-5, C-1

## P

parallel port  
 connector and signals, D-7 to D-8  
 DMA level, PC configuration, 3-11  
 PC configuration, 3-9 to 3-11  
 Ethernet power-on defaults, 3-11  
 GPIB interrupt level, 3-10  
 parallel port DMA level, 3-11  
 SCSI termination, 3-10  
 system CMOS, 3-10 to 3-11  
 PCI interrupts, B-1

**PCMCIA controller**

- computer hangs on CSALLOC, F-4
- interface technical information, 5-9
- software installation, 5-8

performance specifications, A-2

**peripherals****drivers**

- installing, 5-2
- memory requirements, 5-2

Ethernet controller, 5-6 to 5-8

GPIO (IEEE 488.2), 5-10

IDE controller, 5-4 to 5-5

PCMCIA controller, 5-8 to 5-9

SCSI controller, 5-9 to 5-10

video, 5-3 to 5-4

VXIpc-850 components (table), 5-1

physical specifications, A-1

plug-in boards. *See* I/O expansion boards.

problems and solutions, F-1 to F-4

**Q**

questions and answers about VXIpc-850,  
F-1 to F-4

**R****RAM**

adding SIMM modules, A-3 to A-4

disabling memory checks when  
booting, F-4

installed system RAM, 3-9

memory specifications, A-2

RX LED, 1-6, C-3

**S****SCSI interface**

booting from external SCSI hard  
drive, F-4

connector and signals, D-8 to D-10

interface technical information,  
5-9 to 5-10

setting up in BIOS, F-2

software installation, 5-9

termination, PC configuration, 3-10

using internal IDE drive and external  
SCSI hard drive, F-4

serial port connectors and signals, D-6

**signals**

COM1 and COM2 connectors  
(table), D-6

Ethernet connector (table), D-5

GPIO (IEEE 488.2) (table), D-11

parallel port (table), D-8

SCSI interface (table), D-9 to D-10

SMB (table), D-12

characteristics, D-15

speaker characteristics (table), D-15

VGA connector (table), D-4

VXIbus P1 and P2 (table), D-13

**Slot 0 capability**

configuration as Slot 0 or non-Slot 0,  
3-4 to 3-5, F-3

installation of VXIpc-850  
(warning), 3-12

overview, 1-4

**SMB**

connector location and pinout  
(figure), D-12

signals (table), D-12

characteristics, D-15

software, optional, 1-2 to 1-3

**speaker**

connecting external speaker to  
VXIpc-850, F-3

connector location (figure), D-14

signal characteristics (table), D-15

specifications

- adding RAM, A-3 to A-4
- electrical, A-1
- environmental, A-2
- memory requirements, A-2
- performance, A-2
- physical, A-1
- VMEbus capability codes, A-3

switch settings, 3-3. *See also* configuration.

SYSFAIL LED, 1-5, C-1

system CMOS, PC configuration, 3-10 to 3-11

system resources

- PCI interrupts, B-1
- resource tables
  - DMA channel resource allocations, B-2
  - I/O address map, B-3
  - ISA interrupt resource allocations, B-1 to B-2

system startup cycle and LEDs, C-2 to C-3

## T

technical support, G-1 to G-2

telephone and fax support, G-2

terminal. *See* monitor.

TEST LED, 1-5, C-1

TNT4882C custom ASIC, 1-4 to 1-5

Trident video accelerator, 5-3 to 5-4

trigger input termination, 3-7

troubleshooting problems, F-1 to F-4

TX LED, 1-6, C-3

## V

VGA connector, D-3 to D-4

video accelerator. *See also* monitor.

- interface technical information, 5-3 to 5-4
- pre-installed driver for, 5-3
- questions and answers, F-2
- Super VGA monitor (caution), 5-3
- Trident video manual, 5-3
- VGA connector, D-3 to D-4

VMEbus capability codes, A-3

VXIbus

- accessing 32-bit registers, F-1
- CLK10 routing, 3-5 to 3-7
- interface status LEDs, 1-5, C-1
- P1 and P2 connectors and signals, D-12 to D-13
- Slot 0 capability
  - configuration, 3-4 to 3-5, F-3
  - overview, 1-4

VXIpc-850 Series

- block diagram, 2-2
- embedded computer (figure), 1-1
- functional description, 2-1 to 2-3
- hardware description, 1-3 to 1-6
  - custom application-specific interface chips, 1-4 to 1-5
  - front panel features, 1-5 to 1-6
  - models available, 1-3 to 1-4
  - peripheral expansion, 1-6
  - Slot 0 functionality, 1-4
- logic blocks, 2-3
- optional equipment, 1-2
- optional software, 1-2 to 1-3
- overview, 1-2
- upgrading, F-4

## W

WinBIOS

- entering setup, 4-1 to 4-2
  - keyboard use, 4-2
  - mouse use, 4-1
- main menu, 4-3