



Artisan Technology Group is your source for quality new and certified-used/pre-owned equipment

- FAST SHIPPING AND DELIVERY
- TENS OF THOUSANDS OF IN-STOCK ITEMS
- EQUIPMENT DEMOS
- HUNDREDS OF MANUFACTURERS SUPPORTED
- LEASING/MONTHLY RENTALS
- ITAR CERTIFIED SECURE ASSET SOLUTIONS

SERVICE CENTER REPAIRS

Experienced engineers and technicians on staff at our full-service, in-house repair center

*InstraView*SM REMOTE INSPECTION

Remotely inspect equipment before purchasing with our interactive website at www.instraview.com ↗

WE BUY USED EQUIPMENT

Sell your excess, underutilized, and idle used equipment. We also offer credit for buy-backs and trade-ins. www.artisanng.com/WeBuyEquipment ↗

LOOKING FOR MORE INFORMATION?

Visit us on the web at www.artisanng.com ↗ for more information on price quotations, drivers, technical specifications, manuals, and documentation

Contact us: (888) 88-SOURCE | sales@artisanng.com | www.artisanng.com

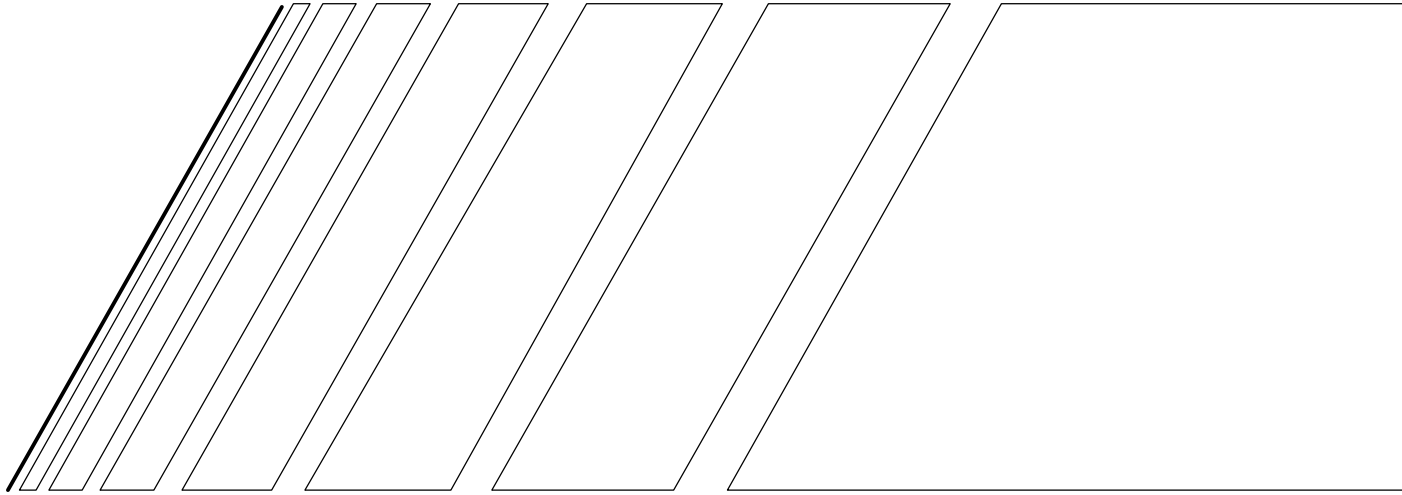

USER'S MANUAL

SYSDRIVE 3G3EV

(Standard Models)

Compact Low-noise Inverter

Thank you for choosing this SYSDRIVE 3G3EV-series product. Proper use and handling of the product will ensure proper product performance, will lengthen product life, and may prevent possible accidents.

Please read this manual thoroughly and handle and operate the product with care.

NOTICE

1. This manual describes the functions of the product and relations with other products. You should assume that anything not described in this manual is not possible.
2. Although care has been given in documenting the product, please contact your OMRON representative if you have any suggestions on improving this manual.
3. The product contains potentially dangerous parts under the cover. Do not attempt to open the cover under any circumstances. Doing so may result in injury or death and may damage the product. Never attempt to repair or disassemble the product.
4. We recommend that you add the following precautions to any instruction manuals you prepare for the system into which the product is being installed.
 - Precautions on the dangers of high-voltage equipment.
 - Precautions on touching the terminals of the product even after power has been turned off. (These terminals are live even with the power turned off.)
5. Specifications and functions may be changed without notice in order to improve product performance.

Items to Check Before Unpacking

Check the following items before removing the product from the package:

- Has the correct product been delivered (i.e., the correct model number and specifications)?
- Has the product been damaged in shipping?
- Are any screws or bolts loose?

Table of Contents

Chapter 1. Getting Started	1-1
1-1 Items to be Checked when Unpacking	1-2
1-2 Precautions	1-3
Chapter 2. Overview	2-1
2-1 Features	2-2
2-2 Component Names	2-4
Chapter 3. Design	3-1
3-1 Installation	3-2
3-1-1 Outside/Mounting Dimensions	3-2
3-1-2 Installation Conditions	3-5
3-2 Wiring	3-7
3-2-1 Terminal Blocks	3-7
3-2-2 Wiring Around the Main Circuit	3-11
3-2-3 Wiring Control Circuit Terminals	3-18
Chapter 4. Preparing for Operation	4-1
4-1 Preparation Procedure	4-2
4-2 Using the Digital Operator	4-3
4-2-1 Name and Function of Each Component	4-3
4-2-2 Outline of Operation	4-5
4-2-3 Setting Constants	4-8
4-3 Test Run	4-25
4-3-1 Checking Wiring	4-25
4-3-2 Turning Power On and Checking Indicator Display	4-25
4-3-3 Initializing Constants	4-25
4-3-4 Setting a V/f Pattern	4-25
4-3-5 Setting Rated Motor Amperage	4-26
4-3-6 Setting the Reference Frequency	4-26
4-3-7 Operating the Inverter with the Digital Operator	4-26
4-3-8 Checking Output Frequency and Amperage	4-26
4-3-9 Checking Operation during Reverse Rotation	4-26
4-3-10 Checking Operation with Mechanical System Connected	4-26
4-3-11 Checking Operation Performed by Controller	4-26

Table of Contents

Chapter 5. Operation	5-1
5-1 Protective and Diagnostic Functions	5-2
5-2 Troubleshooting	5-8
5-2-1 Constants Fail to Set	5-8
5-2-2 Motor Fails to Operate	5-8
5-2-3 Motor Rotates in the Wrong Direction	5-9
5-2-4 Motor Deceleration is Too Slow	5-10
5-2-5 Vertical-axis Load Drops when Brakes are Applied	5-10
5-2-6 Motor Burns	5-11
5-2-7 Controller Receives Noise when Inverter is Started	5-11
5-2-8 AM Radio Receives Noise when Inverter is Started	5-11
5-2-9 Ground Fault Interrupter is Actuated when Inverter is Started	5-12
5-2-10 Mechanical System Makes Noise	5-12
5-2-11 Motor Does Not Operate with EF Warning	5-12
5-3 Maintenance and Inspection	5-13
Chapter 6. Specifications	6-1
6-1 Specifications of Main Unit	6-2
Chapter 7. Appendix A	7-1
7-1 Notes on Using Inverter for Motor	7-2
7-2 Frequency Reference by Amperage Input	7-4
7-3 List of Product Models	7-7

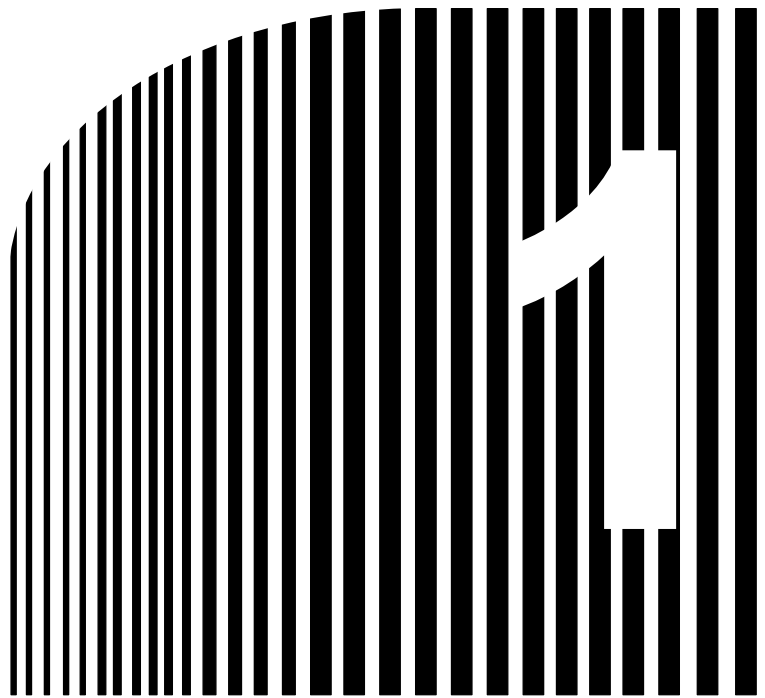

Chapter 1

• Getting Started •

- 1-1 Items to be Checked when Unpacking
- 1-2 Precautions

1-1 Items to be Checked when Unpacking

■ Checking the Product

On delivery, always check that the delivered product is the SYSDRIVE 3G3EV Inverter that you ordered.

Should you find any problems with the product, immediately contact your nearest local sales representative.

● Checking the Nameplate

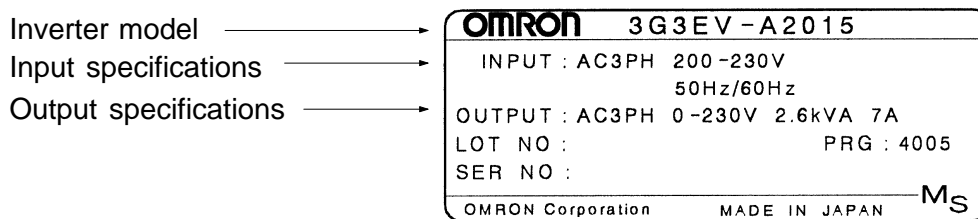

● Checking the Model

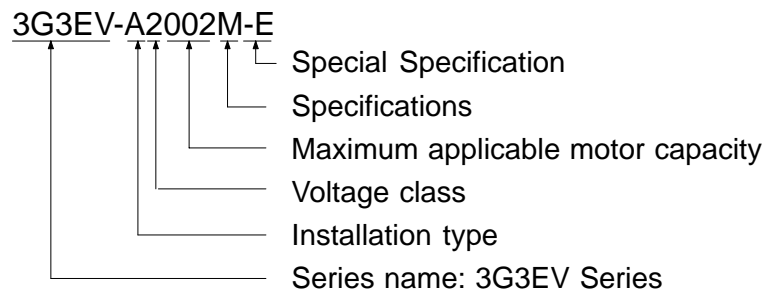

Specifications

Blank	Standard model
M	Multi-function model
R	SYSMAC BUS model

Maximum Applicable Motor Capacity

001	0.1 kW
002	0.2 (0.37) kW
004	0.4 (0.55) kW
007	0.75 (1.1) kW
015	1.5 kW

Note The figures in parentheses indicate capacities for 400-VAC class models.

Voltage Class

2	Three-phase 200-VAC input
B	Single/Three-phase 200-VAC input

Special Specification

-E	English Models
-CUE	UL/CUL and EC Directives Models
Blank	Japanese Models

Installation Type/Option

A	Panel mounting
P	Option

● **Checking for Damage**

Check the overall appearance and check for damage or scratches resulting from transportation.

■ **Checking Accessories**

Note that this manual is the only accessory provided with the 3G3EV (Standard Model). Set screws and other necessary parts must be prepared by customers.

1-2 Precautions

To ensure safe operation of the 3G3EV, note the following items:

■ **Always Hold the Heat Sink During Removal.**

When moving the 3G3EV, always hold the heat sink (aluminum portion on the rear of the Unit).

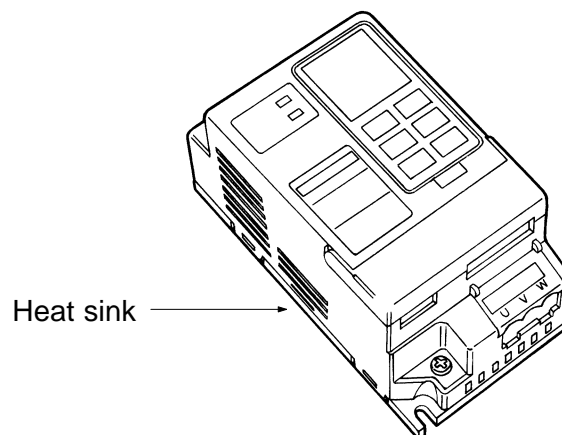

■ **Watch Out for Residual Voltage On Charged Portions**

After the power is turned off, residual voltage remains in the capacitor inside the Inverter. Therefore, touching terminals immediately after turning the power off may cause an electrical shock.

If an inspection or some other task is to be performed, always wait at least one minute from the time all indicators on the front panel go off.

(Note that this warning is applicable whenever you perform any task after turning the main circuit off.)

■ Do Not Remove the Digital Operator When the Main Circuit is Still On.

Always turn the main circuit off before removing the digital operator.

Removing the digital operator with the main circuit ON may cause an electrical shock and damage the equipment.

■ Do Not Modify Wiring or Check Signals When the Main Circuit is On.

Always turn the main circuit off before modifying wiring or checking signals.

Touching terminals while the main circuit is on may cause an electrical shock and damage the equipment.

■ Do Not Conduct a Dielectric Strength Test.

Because the 3G3EV Inverter is an electronic control unit using semiconductor, never conduct a dielectric strength test or an insulation resistance test for the control circuit.

■ Modify Constant Settings Correctly.

Always modify the constant settings according to the procedures described in this manual.

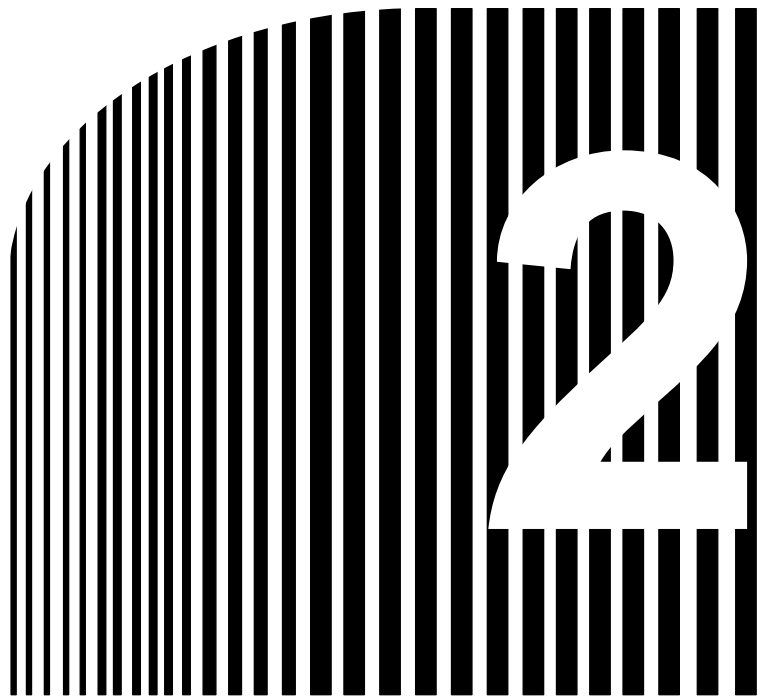

Chapter 2

• Overview •

2-1 Features

2-2 Component Names

2-1 Features

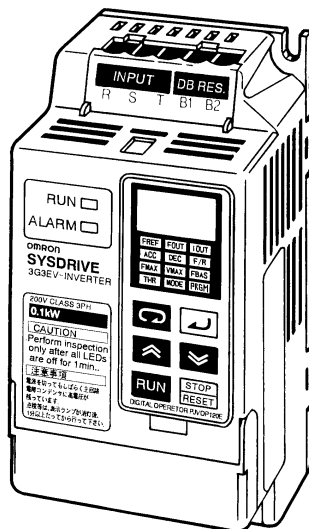

■ Easy to Use

● Basic Constants Displayed On Indicators

Constants for basic operations such as frequency setting and acceleration/deceleration time setting are displayed on dedicated indicators. Therefore, constant numbers can be confirmed easily.

● Minimum Constant Setting Items

Constant setting items have been minimized to enable even first-time users to set constants easily.

■ Easy to Install

● Very Small and Lightweight

The 3G3EV Inverter is approximately half the size of our Low-noise General-purpose Inverters in terms of volume and weight percentage. This improves space efficiency and operating efficiency (including easier removal).

● Optional DIN Track

An optional DIN track is available. This DIN track enables the user to mount the 3G3EV Inverter on the DIN track with a one-touch operation.

■ Easy to Wire

● Easy Wiring without Having to Open the Front Cover

This Inverter can be wired just by opening the terminal block cover.

● Separate Input and Output Terminal Blocks

Power input terminals are located in the upper section, while motor output terminals are in the lower section. In this way, the input and output terminal blocks are separated according to the contactors, so incorrect wiring can be prevented.

● Soldering No Longer Necessary

No connector means no soldering.

■ Easy to Operate

● Switching the Operation Mode with a One-touch Operation

For example, after a test run is performed using the Digital Operator, it can be easily switched to a production run using control terminals with a one-touch operation.

● Checking a Test Run with Various Monitors

Output frequency, output current, and the direction of motor rotation appear in the display section of the Digital Operator, so the mechanical system can be easily monitored during a test run.

■ Low Noise

An insulated gate bipolar transistor (IGBT) power element has been adopted to eliminate metallic noise.

■ High-torque Operation Even in Low Speed Range

A torque rate of 150% can be achieved even in a low speed range where output frequency is only 3 Hz. Thus, acceleration time can be reduced.

■ Various Input Power Supplies

A 400-VAC-class Inverter has been newly added to the 3G3EV Series to cope with various power supplies.

- Three-phase 200-VAC input: 0.1 to 1.5 kW
- Single/Three-phase 200-VAC input: 0.1 to 1.5 kW
- Three-phase 400-VAC input: 0.2 to 1.5 kW

2-2 Component Names

■ Main Unit

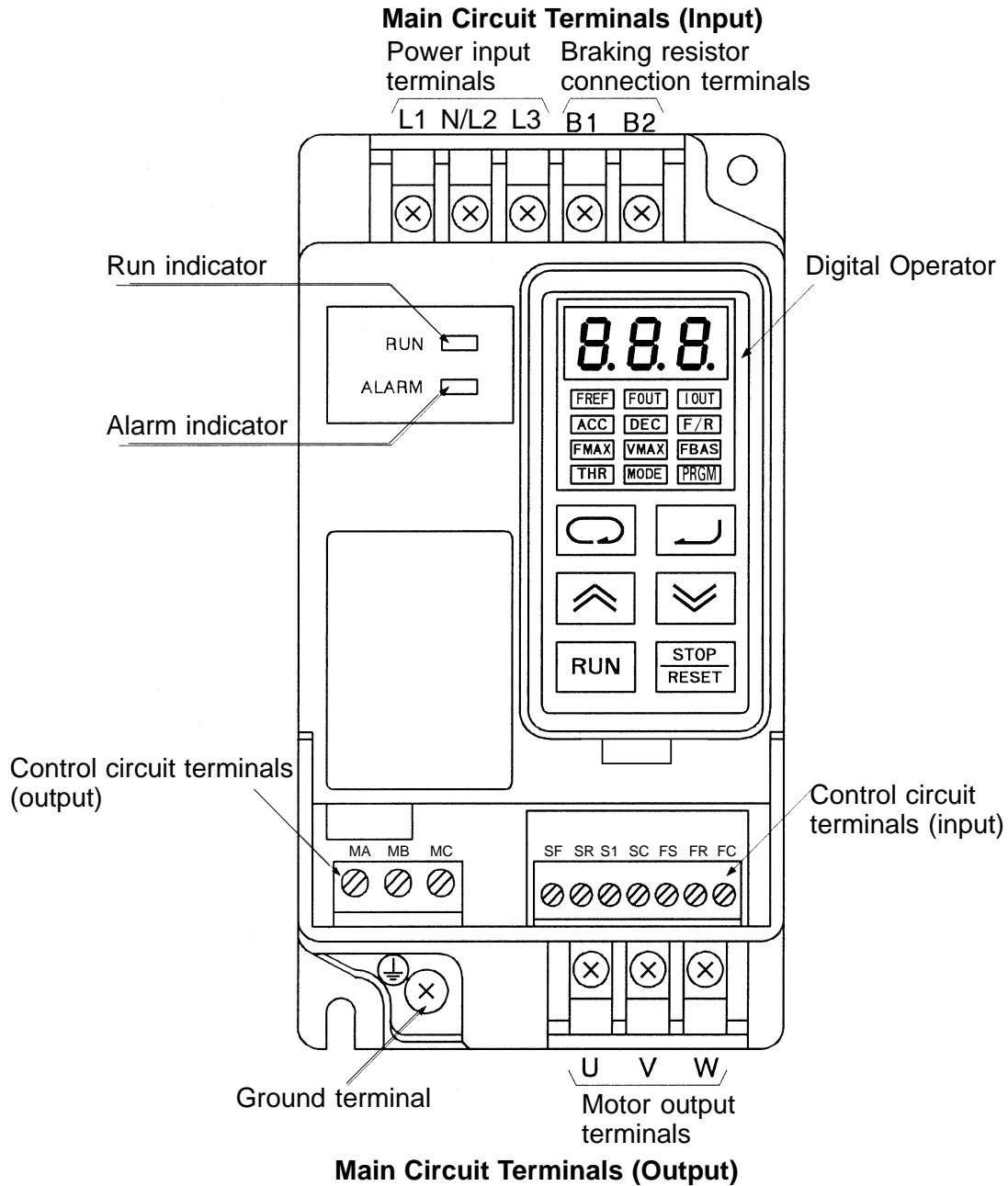

Note This diagram shows the Inverter with all terminal block covers removed.

■ Digital Operator

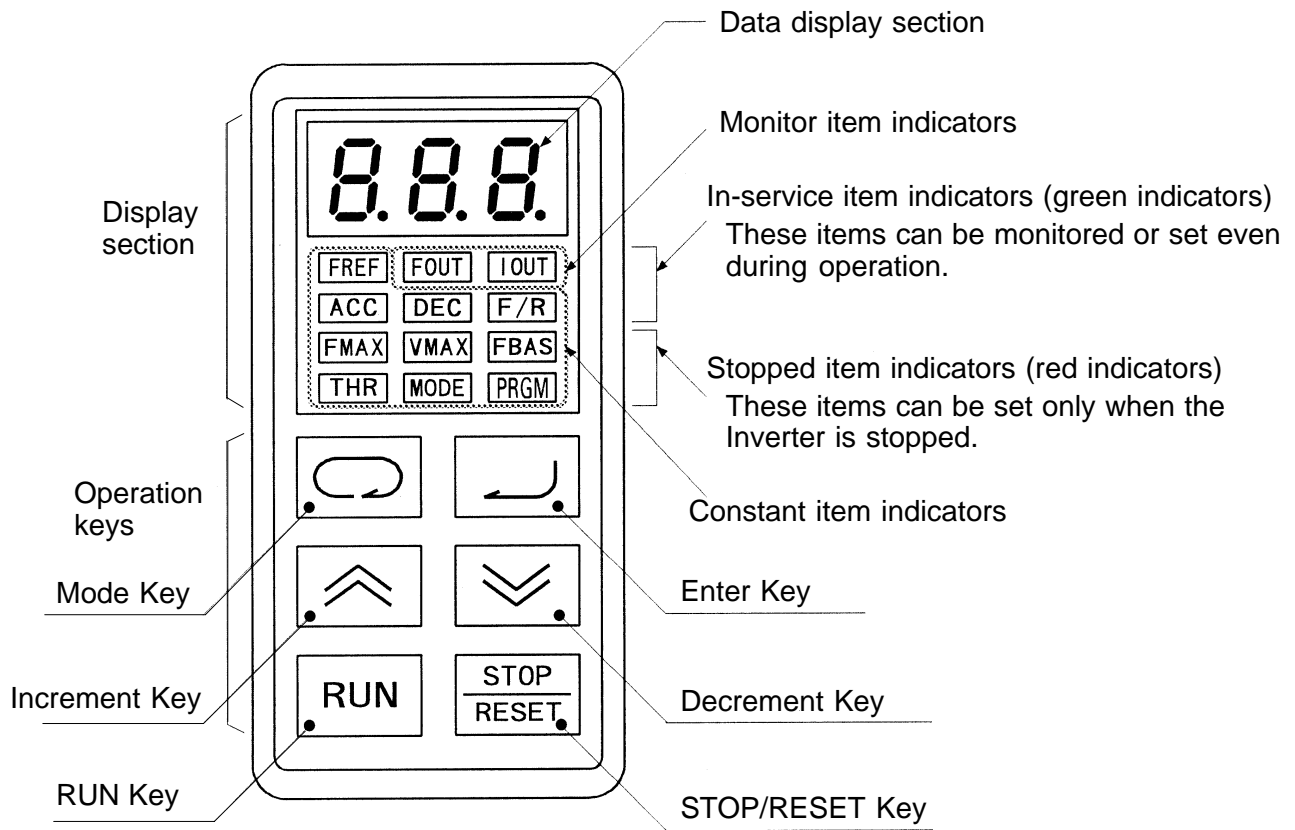

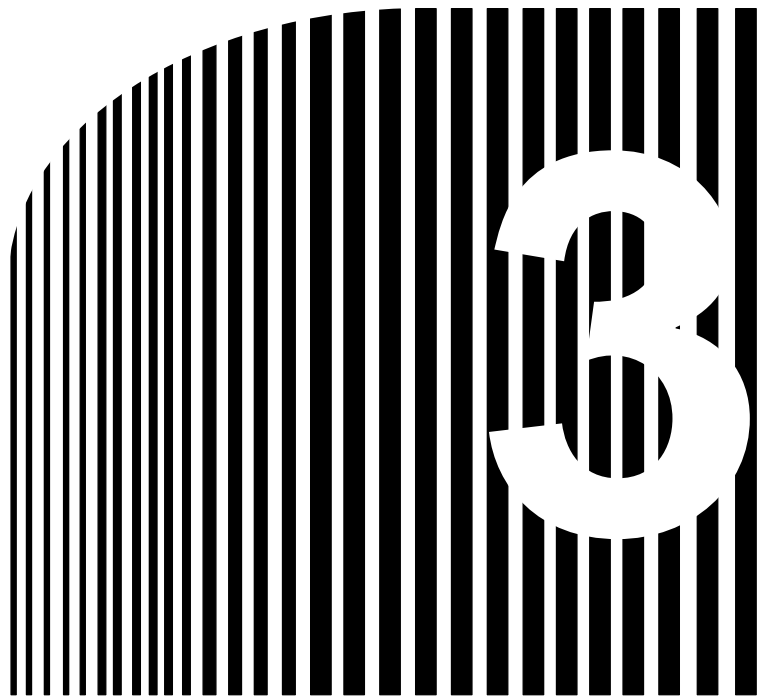

Chapter 3

• Design •

3-1 Installation

3-2 Wiring

3-1 Installation

3-1-1 Outside/Mounting Dimensions

Note All dimensions are in millimeters.

- **3G3EV-A2001(-□) to 3G3EV-A2004(-□) (0.1 to 0.4 kW):
Three-phase 200-VAC Input**
- **3G3EV-AB001(-□) to 3G3EV-AB002(-□) (0.1 to 0.2 kW):
Single/Three-phase 200-VAC Input**

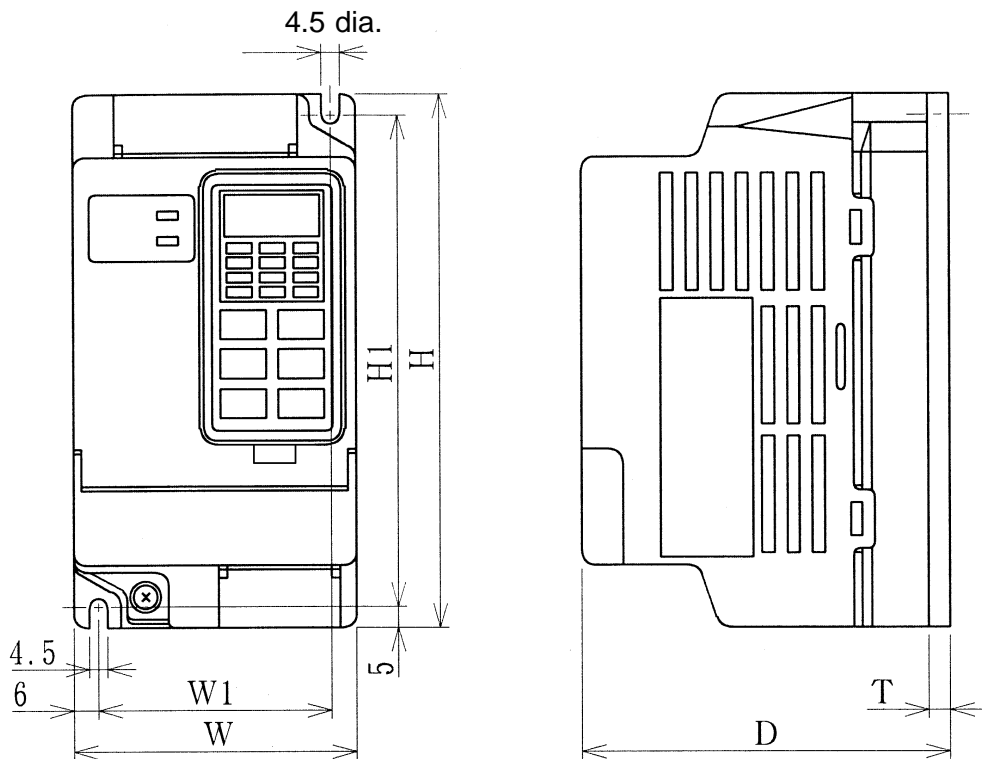

Note 1. For the 3G3EV-A2001(-□), 3G3EV-A2002(-□), and 3G3EV-AB001(-□), a U-shaped notch (4.5 mm wide) is provided instead of the upper mounting hole (4.5 mm in diameter).

Note 2. Install the Inverter with two M4 bolts.

● Three-phase 200-VAC Input Model

3G3EV model	Output	W	H	D	W1	H1	T	Weight (kg)
A2001(-□)	0.1 kW	68	128	75	56	118	3	Approx. 0.5
A2002(-□)	0.2 kW			88				Approx. 0.6
A2004(-□)	0.4 kW			110				Approx. 0.9

● Single/Three-phase 200-VAC Input Model

3G3EV model	Output	W	H	D	W1	H1	T	Weight (kg)
AB001(-□)	0.1 kW	68	128	75	56	118	3	Approx. 0.5
AB002(-□)	0.2 kW			108				Approx. 0.6

- 3G3EV-A2007(-□) to 3G3EV-A2015(-□) (0.75 to 1.5 kW):
Three-phase 200-VAC Input
- 3G3EV-AB004(-□) to 3G3EV-AB015(-□) (0.4 to 1.5 kW):
Single/Three-phase 200-VAC Input
- 3G3EV-A4002(-□) to 3G3EV-A4015(-□) (0.2 to 1.5 kW):
Three-phase 400-VAC Input

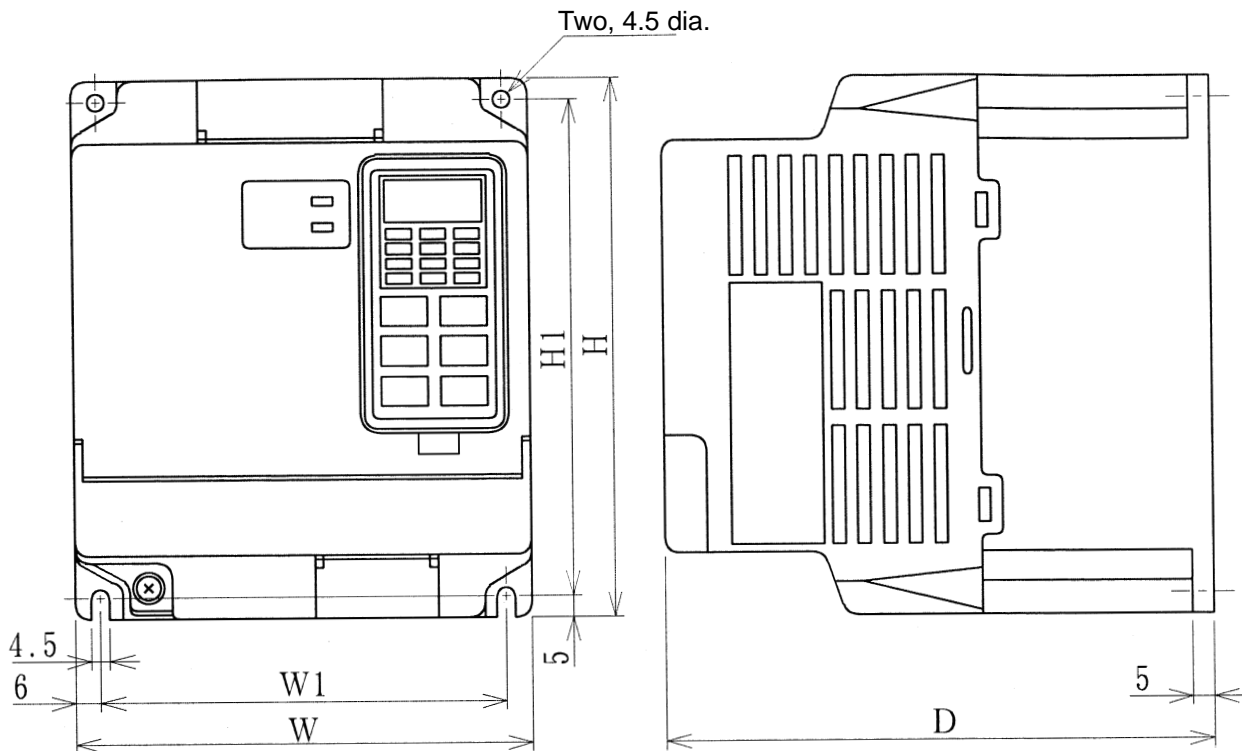

Note Install the Inverter with four M4 bolts.

● **Three-phase 200-VAC Input Model**

3G3EV model	Output	W	H	D	W1	H1	Weight (kg)
A2007(-□)	0.75 kW	108	128	130	96	118	Approx. 1.3
A2015(-□)	1.5 kW			155			Approx. 1.5

● **Single/Three-phase 200-VAC Input Model**

3G3EV model	Output	W	H	D	W1	H1	Weight (kg)
AB004(-□)	0.4 kW	108	128	130	96	118	Approx. 1.3
AB007(-□)	0.75 kW						Approx. 1.3
AB015(-□)	1.5 kW	130		170	118		Approx. 2.0

● **Three-phase 400-VAC Input Model**

3G3EV model	Output	W	H	D	W1	H1	Weight (kg)
A4002(-□)	0.2 kW	108	128	92	96	118	Approx. 1.0
A4004(-□)	0.4 kW			110			Approx. 1.0
A4007(-□)	0.75 kW			140			Approx. 1.5
A4015(-□)	1.5 kW	130		170	118		Approx. 2.0

3-1-2 Installation Conditions

■ **Installation Site**

- Install the Inverter under the following conditions:

Ambient temperature for operation: -10°C to 50°C

Humidity: 90% RH or less (non-condensing)

- Install the Inverter in a clean location free from oil mist and dust. Alternatively, install it in a totally enclosed panel that is completely shielded from suspended dust.
- When installing or operating the Inverter, always take special care so that metal powder, oil, water, or other foreign matter do not get in the Inverter.
- Do not install the Inverter on inflammables such as wood.

■ **Direction of Installation**

- Install the Inverter on a vertical surface so that the characters on the nameplate are oriented upward.

■ **Installation Space**

- When installing the Inverter, always provide the following installation space to allow normal heat dissipation from the Inverter:

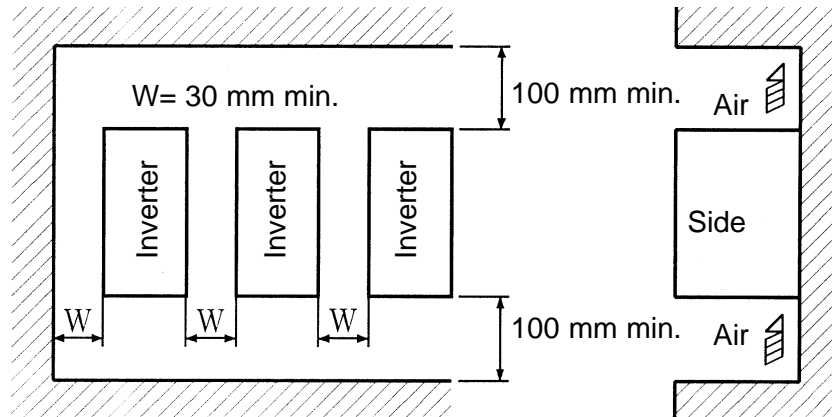

■ **Ambient Temperature Control**

- To enhance operation reliability, the Inverter should be installed in an environment free from extreme temperature rises.
- If the Inverter is installed in an enclosed environment such as a box, use a cooling fan or air conditioner to maintain the internal air temperature below 50°C .
- The surface temperature of the Inverter may reach 30°C higher than the ambient temperature. Therefore, keep all thermally susceptible devices and wires away from the Inverter.

■ **Protecting the Inverter from Foreign Matter during Installation**

- Place a cover over the Inverter to shield it from metal powder produced by drilling during installation.

(Upon completion of installation, always remove the cover from the Inverter. Otherwise, ventilation will be affected, causing the invert to overheat.)

3-2 Wiring

3-2-1 Terminal Blocks

■ Name of Each Terminal Block

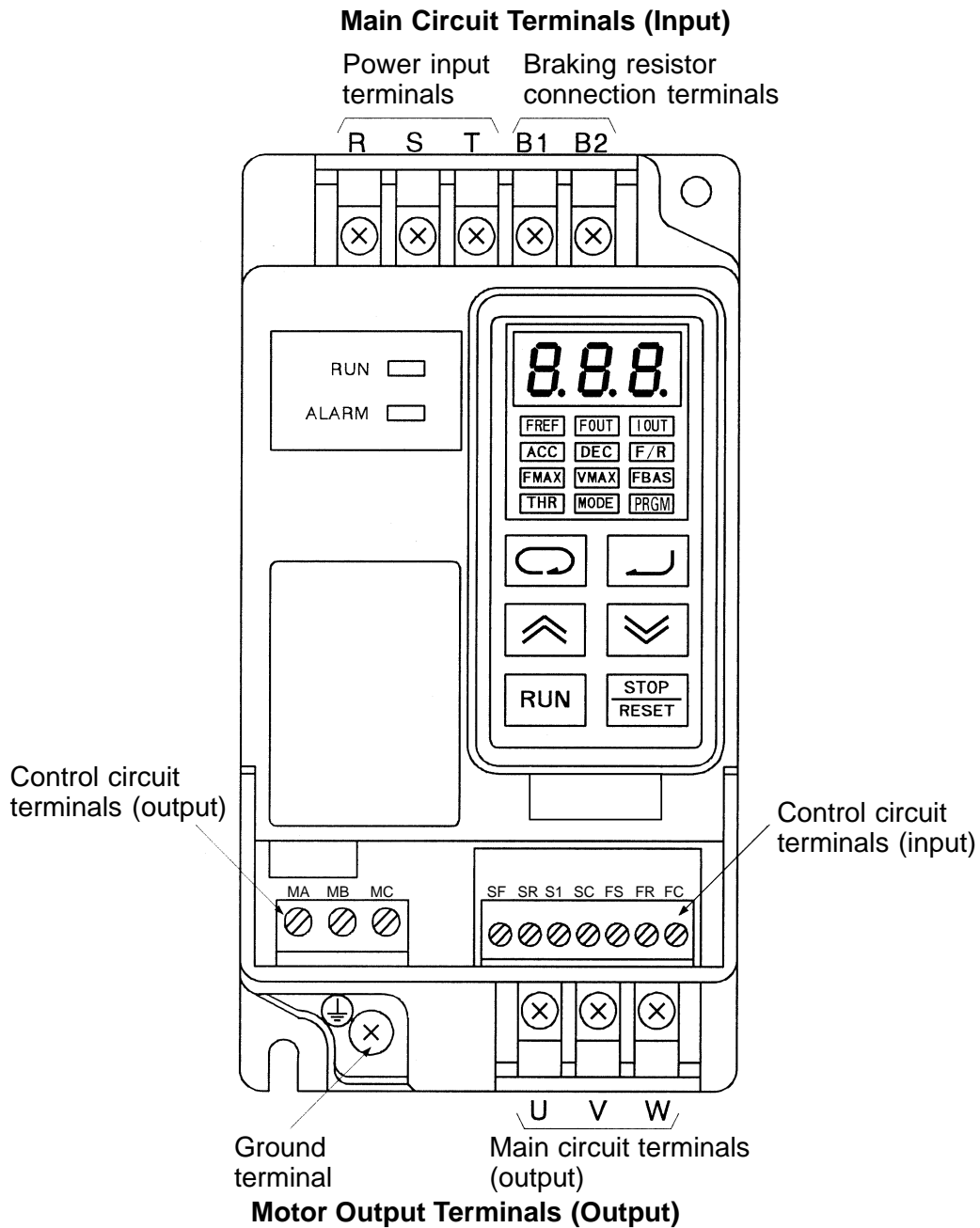

Note This diagram shows an Inverter with all terminal block covers removed.

■ Main Circuit Terminals

● Input Terminals (Top Section)

Terminal symbol	Name and description
R (L1)	Power input terminals A2□: Three-phase 200 to 230 VAC, 50/60 Hz AB□: Single-phase 200 to 240 VAC, 50/60 Hz Three-phase 200 to 230 VAC, 50/60 Hz A4□: Three-phase 380 to 460 VAC, 50/60 Hz Note: Single-phase power must be input between terminals R to S.
S (L2/N)	
T (L3)	
B1	Braking resistor connection terminals (see note) Terminals for connecting an optional braking resistor
B2	

Note Before shipping, a resin plate is attached to each braking resistor connection terminal to prevent incorrect wiring.
 When connecting a braking resistor, always remove the resin plates with a pair of long-nose pliers.

● Output Terminals (Bottom Section)

Terminal symbol	Name and description
U V W	Motor output terminals Three-phase power output terminals for operating the motor. (Never connect an AC power supply to these terminals.) A2□, AB□: Three-phase 200 to 230 VAC A4□: Three-phase 380 to 460 VAC Note: Depending on input voltage
	Ground terminal Always use a ground terminal with one of the following ground resistances: 100 Ω or less for 200-VAC class 10 Ω or less for 400-VAC class. (Connect also to the power supply neutral to conform to the EC Directives.) Be sure to connect a grounding line to the FG terminal and also connect directly to the FG terminal of the motor.

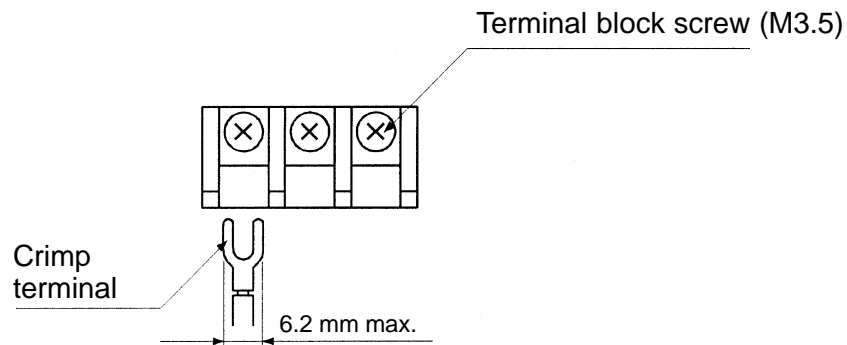

■ Control Circuit Terminals

● Input Terminals (On Right-hand Side)

No external power supply is required because a built-in power supply is provided.

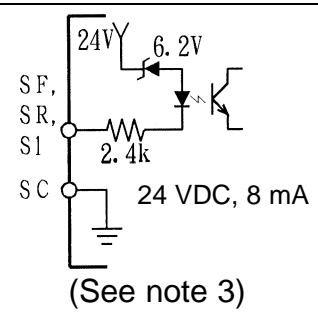
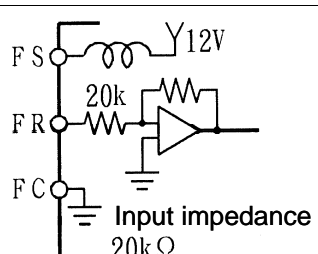
Terminal symbol	Name and description	Interface
SF	Forward/Stop When the terminal is ON, the motor rotates in the forward direction. When the terminal is OFF, the motor stops.	 <p>(See note 3)</p>
SR	Reverse/Stop When the terminal is ON, the motor reverses. When the terminal is OFF, the motor stops.	
S1	Multi-function input (see note 1)	
SC	Sequence input common Input terminal common to SF, SR, and S1	
FS	Frequency reference power supply Output voltage: 12 VDC Permissible amperage: 20 mA	 <p>Input impedance 20kΩ</p>
FR	Frequency reference input (see note 2) 0 to 10 VDC is input.	
FC	Frequency reference common	

Note 1. Constant No. 06 (n06) is used to set this function. This constant is factory-set to “fault reset.”

Note 2. FR can be switched to an amperage input terminal (4 to 20 mA) by setting the internal DIP switch and constant No. 02 (operation mode selection). For details, refer to 7-2 *Frequency Reference by Amperage Input*.

Note 3. The circuit for a 400-VAC-class Inverter is as shown below.

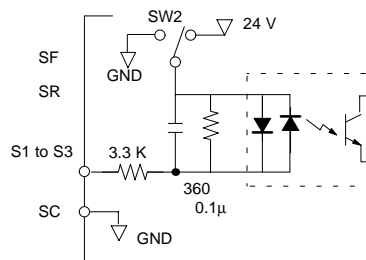

● Output Terminals (On Left-hand Side)

Terminal symbol	Name and description	Interface
MA	Multi-function contact output (contact a) (see note)	
MB	Multi-function contact output (contact b) (see note)	
MC	Multi-function contact output (common)	

Note Constant No. 09 (n09) is used to set the function. This constant is factory set to “operation in progress.”

■ Standard Connection Diagram

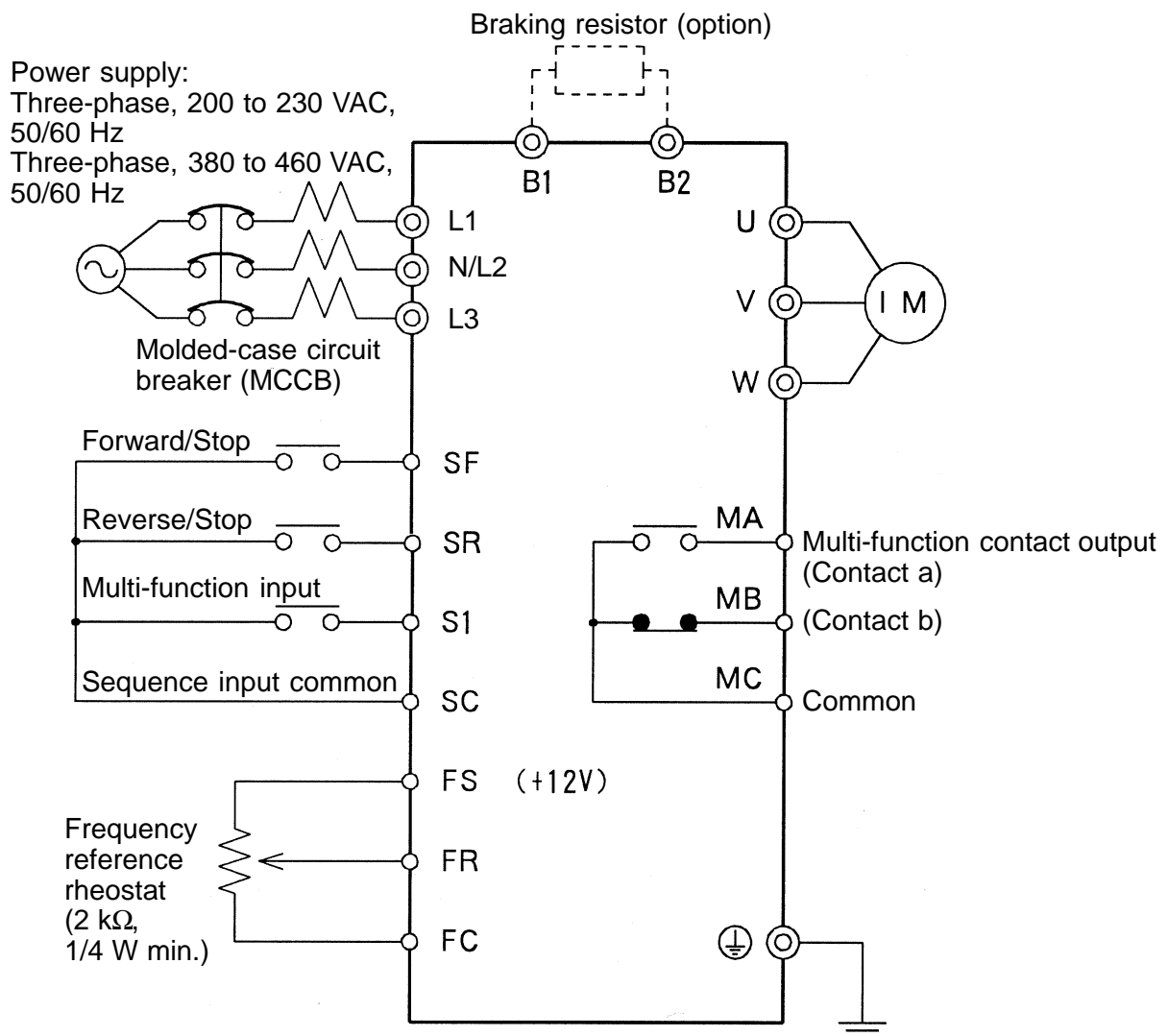

Note 1. If a 3G3EV-AB□□□ is used in single-phase input mode, single-phase 200 to 240 VAC power with a frequency of 50/60 Hz must be input between terminals R and S.

Note 2. For the 3-wire sequence, refer to the wiring on page 4-12.

Note 3. The input sequence power is built in.

3-2-2 Wiring Around the Main Circuit

System reliability and noise resistance are affected by the wiring method used. Therefore, always follow the instructions given below when connecting the Inverter to peripheral devices and other parts.

■ Wire Size and Molded-Case Circuit Breaker to be Used

For the main circuit and ground, always use 600-V polyvinyl chloride (PVC) cables.

If the cable is long and may cause voltage drops, increase the wire size according to the cable length.

Model	Terminal symbol	Terminal screw	Wire size (mm ²)	Molded-case circuit breaker capacity (A)
3G3EV-A2001(-□)	R S T B1 B2	M3.5	0.75 to 2	10
3G3EV-AB001(-□)	U V W ⚡			5
3G3EV-A2002(-□)	R S T B1 B2	M3.5	0.75 to 2	5
3G3EV-AB002(-□)	U V W ⚡			
3G3EV-A4002(-□)				
3G3EV-A2004(-□)	R S T B1 B2	M3.5	0.75 to 2	5
3G3EV-AB004(-□)	U V W ⚡			
3G3EV-A4004(-□)				
3G3EV-A2007(-□)	R S T B1 B2	M3.5	0.75 to 2	10
3G3EV-AB007(-□)	U V W ⚡			20
3G3EV-A4007(-□)				5
3G3EV-A2015(-□)	R S T B1 B2	M3.5	0.75 to 2	10
3G3EV-AB015(-□)	U V W ⚡		1.25 to 2	20
3G3EV-A4015(-□)			0.75 to 2	10

Note Tighten the M3.5 terminal screw to the torque of 0.8 N • m.

Determining the Wire Size

Determine the wire size for the main circuit so that line voltage drop is within 2% of the rated voltage.

Line voltage drop V_D is calculated as follows:

$$V_D (V) = \sqrt{3} \times \text{wire resistance } (\Omega/\text{km}) \times \text{wire length (m)} \times \text{amperage (A)} \times 10^{-3}$$

■ Wiring on the Input Side of Main Circuit

● Installing a Molded-case Circuit Breaker

Always connect the power input terminals (R, S, and T) and power supply via a molded-case circuit breaker. Power must be supplied instantaneously. Unstable power startup will not start the Inverter.

● Installing a Ground Fault Interrupter

If a ground fault interrupter is to be connected to the wire on the primary side (R, S, and T) of the main circuit, use either of the following interrupters to prevent malfunctions:

- Ground fault interrupter with a sensitivity amperage of 200 mA or more and with an operating time of 0.1 second or more
- Ground fault interrupter with high-frequency countermeasures (for Inverter)

● Installing a Magnetic Contactor

This Inverter can be used without a magnetic contactor (MC) on the power supply side.

If the power supply for the main circuit is to be shut off because of the sequence, a magnetic contactor can be used instead of a molded-case circuit breaker.

However, when a magnetic contactor is installed on the primary side of the main circuit to forcibly stop a load, note that regenerative braking does not work and the load coasts to a stop.

- A load can be started and stopped by opening and closing the magnetic contactor on the primary side. Note, however, that frequently opening and closing the magnetic contactor may cause the Inverter to break down.
- When the Inverter is operated with a Digital Operator, automatic operation cannot be performed after recovery from a power interruption.

● Connecting Input Power Supply to the Terminal Block

Because the phase sequence of input power supply is irrelevant to the phase sequence (R, S, T) of the terminal block, input power supply can be connected to any terminal on the terminal block.

● Installing an AC Reactor

If the Inverter is connected to a large-capacity power transformer (600 kW or more) or the phase advance capacitor is switched, an excessive peak current may flow through the input power circuit, causing the converter unit to break down. To prevent this, install an optional AC reactor on the input side of the Inverter. This also improves the power factor on the power supply side.

● Installing a Surge Absorber

Always use a surge absorber or diode for the inductive loads to be connected to the Inverter. These inductive loads include magnetic contactors, electromagnetic relays, solenoid valves, solenoids, and magnetic brakes.

● Wiring of Braking Resistor/Braking Resistor Unit

When using an Inverter for loads with a large inertia or for vertical axis loads, regenerative energy will be fed back.

If the regenerative energy exceeds the Inverter capacity, overvoltage will be detected in the main circuit. In such a case, use a Braking Resistor or Braking Resistor Unit.

Note Be sure to create a sequence that will turn OFF the Inverter power supply when resistor overheating occurs. When using a Braking Resistor, be sure to install a thermal relay to detect resistor overheating. When using a Braking Resistor Unit, use an error output contact. Otherwise, a fire may occur.

3G3EV Model	Braking Resistor (Duty Cycle 3%ED)	Braking Resistor Unit (Duty Cycle 10%ED)	Minimum connected resistance
A2001(-□)/AB001(-□)	3G3IV-PERF150WJ401 (400 Ω)	---	200 Ω
A2002(-□)/AB002(-□)			200 Ω
A2004(-□)/AB004(-□)	3G3IV-PERF150WJ201 (200 Ω)	3G3IV-PLKEB20P7 (200 Ω 70 W)	200 Ω
A2007(-□)/AB007(-□)			80 Ω
A2015(-□)/AB015(-□)	3G3IV-PERF150WJ101 (100 Ω)	3G3IV-PLKEB21P5 (100 Ω 260 W)	60 Ω
A4002(-□)/A4004(-□)	3G3IV-PERF150WJ751 (750 Ω)	3G3IV-PLKEB40P7 (750 Ω 70 W)	750 Ω
A4007(-□)			510 Ω
A4015(-□)	3G3IV-PERF150WJ401 (400 Ω)	3G3IV-PLKEB41P5 (400 Ω 260 W)	240 Ω

Note Do not use a Resistor whose resistance is below the minimum connected resistance. Otherwise, the Inverter will be damaged.

● **Installing a Noise Filter on the Power Supply Side**

Install a noise filter to eliminate noise transmitted between the power line and the Inverter.

Wiring Example 1

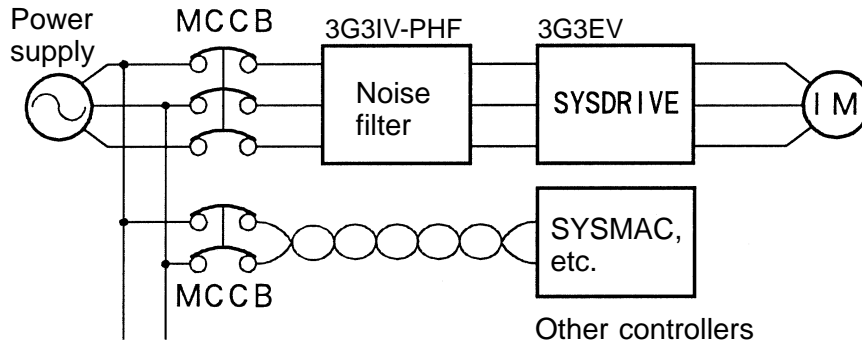

Note Use a special-purpose noise filter for Inverters.

Wiring Example 2

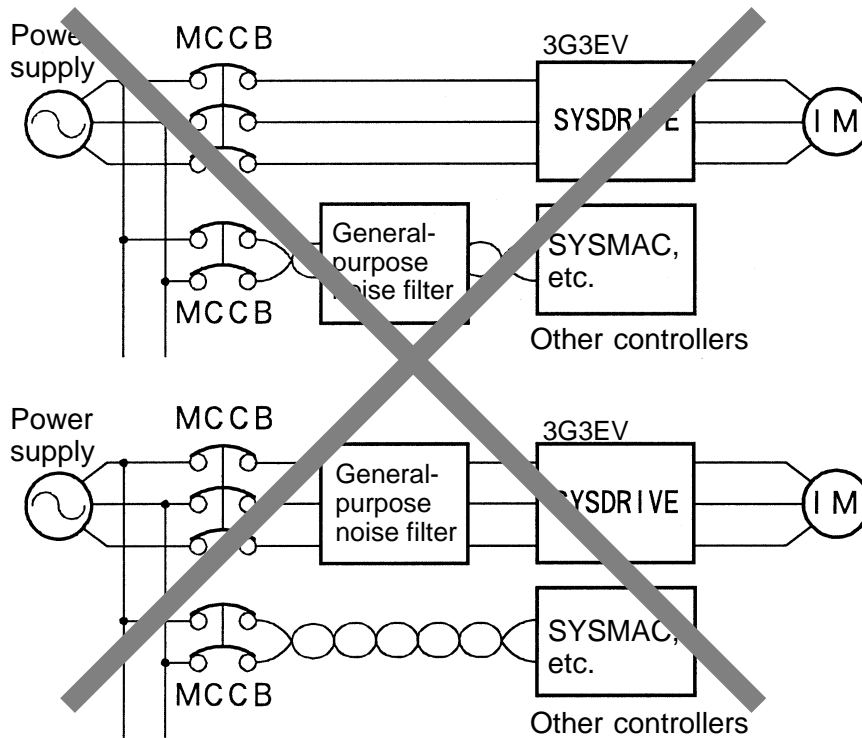

Note Do not use a general-purpose noise filter.

■ **Wiring on the Output Side of Main Circuit**

● **Connecting the Terminal Block to the Load**

Connect output terminals U, V, and W to motor lead wires U, V, and W, respectively.

● **Never Connect Power Supply to Output Terminals**

Caution Never connect a power supply to output terminals U, V, and W.

If voltage is applied to the output terminals, the internal mechanism of the Inverter will be damaged.

● **Never Short or Ground the Output Terminals**

Caution If the output terminals are touched with bare hands or the output wires come into contact with the Inverter casing, an electric shock or grounding will occur.

This is extremely hazardous. Also, be careful not to short the output wires.

● **Do Not Use a Phase Advance Capacitor or Noise Filter**

Never connect a phase advance capacitor or LC/RC noise filter to the output circuit. Doing so may result in damage to the Inverter or cause other parts to burn.

● **Do Not Use an Electromagnetic Switch**

Do not connect an electromagnetic switch or magnetic contactor to the output circuit. If a load is connected to the Inverter during operation, an inrush current will actuate the overcurrent protective circuit in the Inverter.

● **Installing a Thermal Relay**

This Inverter has an electronic thermal protection function to protect the motor from overheating. If, however, more than one motor is operated with one Inverter or a multi-polar motor is used, always install a thermal relay (THR) between the Inverter and the motor and set to “0.0” (no thermal protection) for constant No. 31 (“THR” indicator).

In this case, program the sequence so that the magnetic contactor on the input side of the main circuit is turned off by the contact of the thermal relay.

● **Installing a Noise Filter on the Output Side**

Connect a noise filter to the output side of the Inverter to reduce radio noise and induction noise.

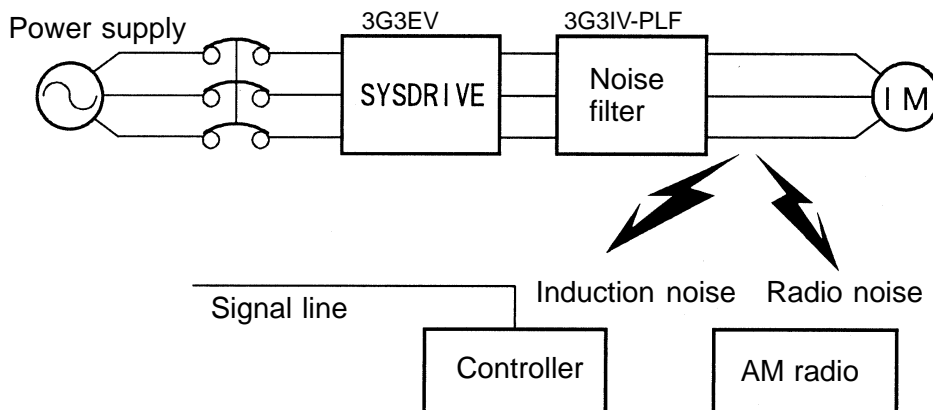

Induction Noise: Electromagnetic induction generates noise on the signal line, causing the controller to malfunction.

Radio Noise: Electromagnetic waves from the Inverter and cables cause the broadcasting radio receiver to make noise.

● How to Prevent Induction Noise

As described above, a noise filter can be used to prevent induction noise from being generated on the output side. Alternatively, cables can be routed through a grounded metal pipe to prevent induction noise. Keeping the metal pipe at least 30 cm away from the signal line considerably reduces induction noise.

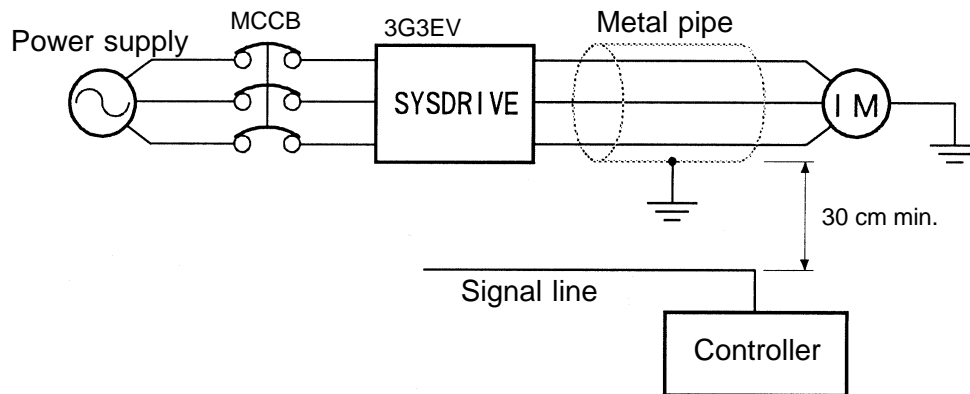

● How to Prevent Radio Noise

Radio noise is generated from the Inverter as well as the input and output lines. To reduce radio noise, install noise filters on both input and output sides, and also install the Inverter in a totally enclosed steel box.

The cable between the Inverter and the motor should be as short as possible.

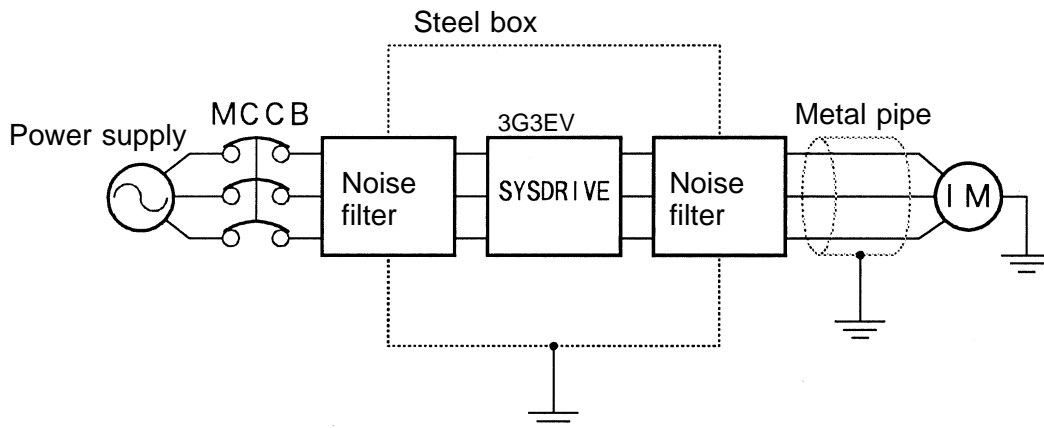

● **Cable Length between Inverter and Motor**

If the cable between the Inverter and the motor is long, the high-frequency leakage current will increase, causing the Inverter output current to increase as well. This may affect peripheral devices. To prevent this, adjust the carrier frequency (set in n37) as shown in the table below.

Cable length between Inverter and motor	50 m max.	100 m max.
Carrier frequency (n37)	10 kHz max. (1, 2, 3, 4)	5 kHz max. (1, 2)

■ **Ground Wiring**

- Always use a ground terminal with the following ground resistance.
 200-VAC Class: 100 Ω or less
 400-VAC Class: 10 Ω or less
- For 400-VAC-class models that conform to EC Directives, also connect to the neutral of the power supply.
- Do not share the ground wire with other devices such as a welder or power tool.
- Always use a ground wire that complies with technical standards on electrical equipment. Route the ground wire so that the total length is as short as possible.
- When using more than one Inverter, be careful not to loop the ground wire.

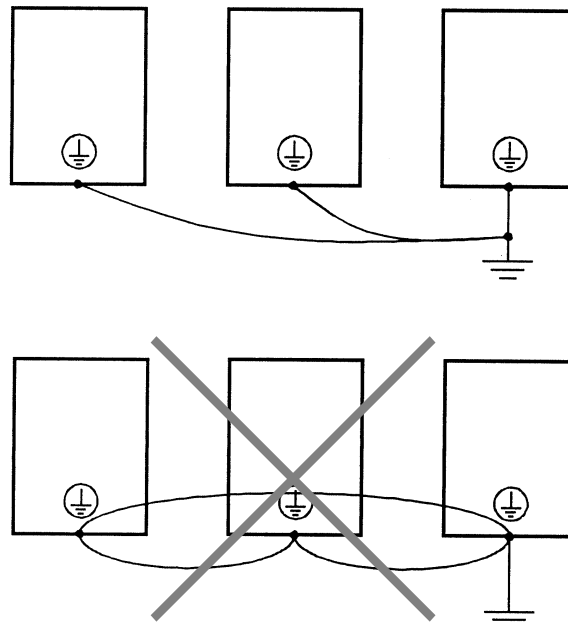

3-2-3 Wiring Control Circuit Terminals

The control signal line must be 50 m or less and must be separated from the power line. If frequency references are input externally, use a twisted-pair shielded line.

■ Wiring Sequence Input/Output Terminals

Wire the sequence input terminals (SF, SR, S1, and SC) and the multi-function contact output terminals (MA, MB, and MC) as described below.

● Wires to be Used

Wire type	Wire size	Wire to be used
Single wire	0.5 to 1.25 mm ²	Polyethylene-shielded cable
Stranded wire	0.5 to 0.75 mm ²	

● Wiring Method

- Wire each terminal as follows:
 - a) Loosen the terminal screw with a thin-slotted screwdriver.
 - b) Insert the wire from underneath the terminal block.
 - c) Tighten the terminal screw firmly.
- Always separate the control signal line from the main circuit cables and other power cables.

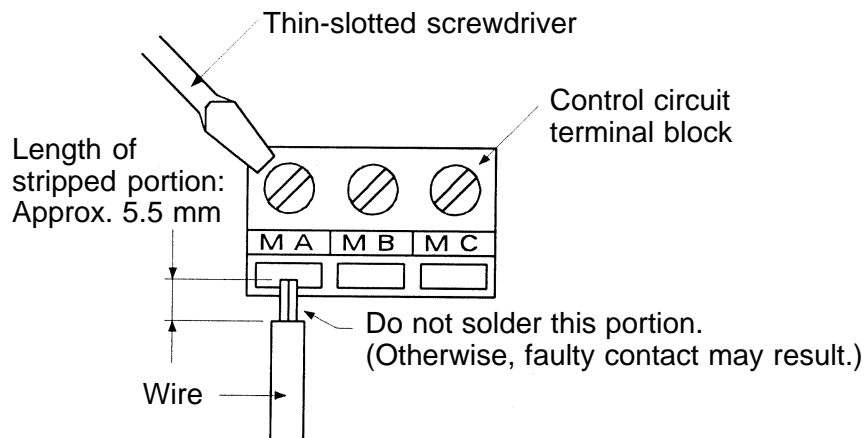

■ Wiring Frequency Reference Input Terminals

If frequency references are input using a D/A unit (digital-to-analog converter) or external power supply, wire the frequency reference input terminals (FR and FC) as described below.

● Wires to be Used

Always use twisted-pair shielded wires to prevent malfunctions due to noise.

Wire type	Wire size	Wire to be used
Single wire	0.5 to 1.25 mm ²	Polyethylene-insulated cable for instrumentation (with shield)
Stranded wire	0.5 to 1.25 mm ²	

● Wiring Method

- The wiring procedure is the same as for sequence input/output terminals, described previously.
- Always separate the cables from the main circuit cables and other power cables.
- Connect the shield to the ground terminal of the Inverter. Do not connect to the controller.
- Insulate the shield with tape to prevent it from coming into contact with other signal lines and devices.

■ Tightening Torque of Control Circuit Terminals

Tighten the control circuit terminals to the torque of 0.5 N • m which is the same torque as for the M3 screws.

Note 1. Applying a torque of greater than 0.5 N • m may damage the terminal block.

Note 2. If the tightening torque is insufficient, wires may be disconnected.

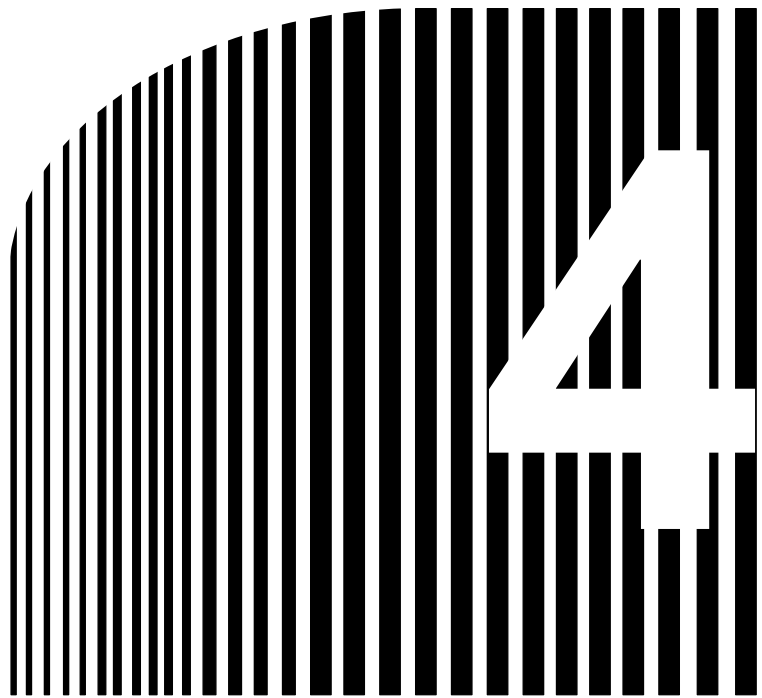

Chapter 4

• Preparing for Operation •

- 4-1 Preparation Procedure
- 4-2 Using the Digital Operator
- 4-3 Test Run

4-1 Preparation Procedure

1. Installation:

Install the Inverter according to installation conditions. Refer to *page 3-2*.

Check that all the installation conditions are met.

2. Wiring:

Connect the Inverter to power supply and peripheral devices. Refer to *page 3-6*.

Select peripheral devices that meet the specifications, and wire them correctly.

3. Turning the Power On:

Check the necessary items, then turn the power on.

Always check that the power voltage is correct and the power input terminals (R, S, and T) are wired correctly.

- Power voltage

- 200-VAC class: Three-phase, 200 to 230 VAC, 50/60 Hz

- 400-VAC class: Three-phase, 380 to 460 VAC, 50/60 Hz

- When a 3G3EV-AB□□□ is used in single-phase input mode, the power voltage must be as follows: single-phase, 200 to 240 VAC, 50/60 Hz (use terminals R and S)

Check that the motor output terminals (U, V, and W) and motor are connected correctly.

Check that the control circuit terminals and controller are connected correctly.

4. Checking Display Status:

Check the Inverter for errors.

If everything is normal, the indicators below become as follows when the power is turned on:

- RUN indicator: Flashing
- ALARM indicator: Not lit
- Constant item indicators: “FREF,” “FOUT,” or “IOUT” is lit.
- Data display: Data corresponding to the constant item indicators is displayed.

If an error exists, the ALARM indicator lights up. In this case, take the necessary action as described in *Section 5 Operation*.

5. Setting Constants:

Use the Digital Operator to set constants required for operation. Refer to *page 4-3*.

Specify each constant as described in this manual.

6. Test Run:

Perform a no-load test run and an actual loading test run to check that the motor and peripheral devices operate normally. Refer to *page 4-25*.

Check the direction of motor rotation and check that the limit switches operate normally. Operate the Inverter with the Digital Operator first, then with the controller.

7. Production Run:

The Inverter is ready to run. If any error has occurred, refer to *Section 5 Operation*.

4-2 Using the Digital Operator

4-2-1 Name and Function of Each Component

■ Name of Each Component

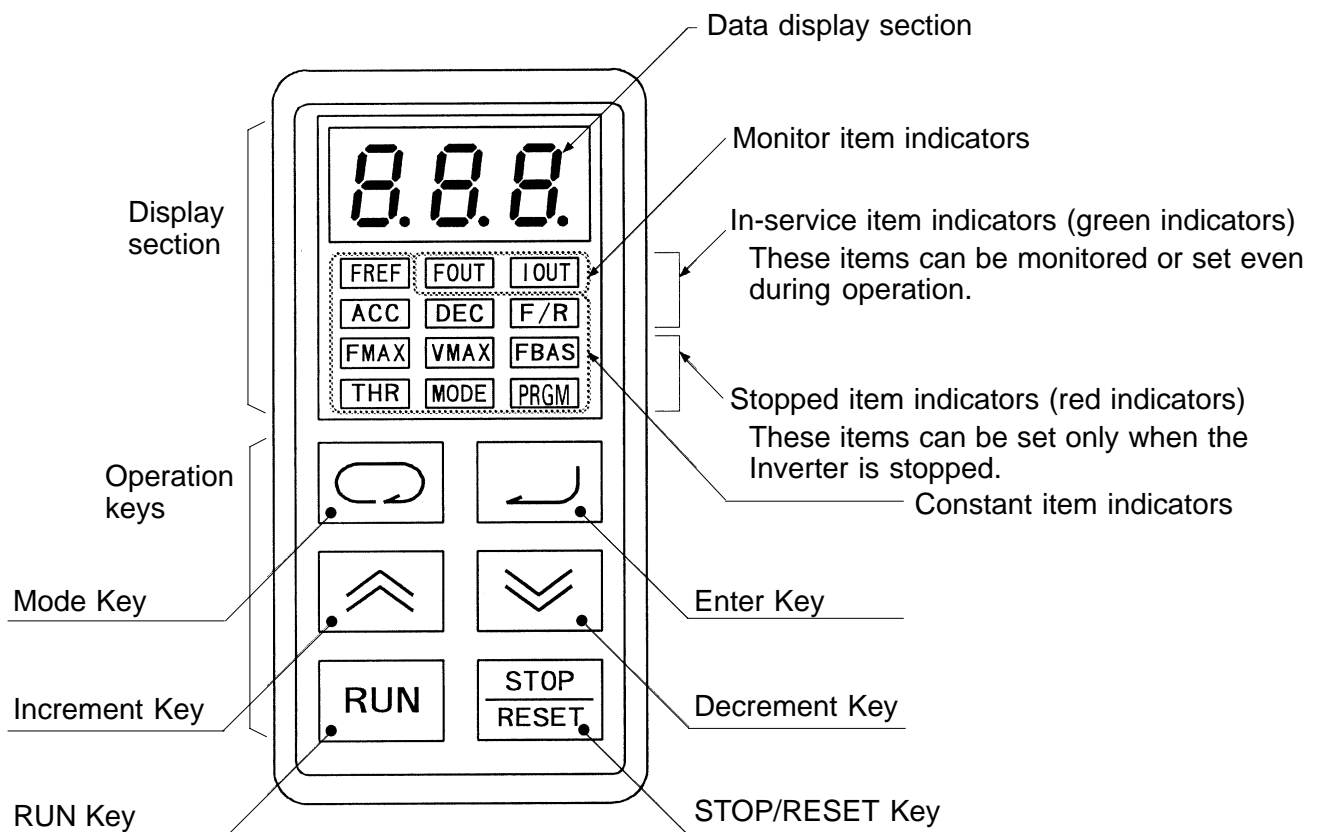

■ Function of Each Component

● Display Sections

Data display section	Reference frequency values, output frequency values, output current values, constant settings, and error codes are displayed.
Monitor item indicators	<div style="border: 1px solid black; padding: 2px; display: inline-block;">FOUT</div> When this indicator is lit, an output frequency value (Hz) is displayed in the data display section. <div style="border: 1px solid black; padding: 2px; display: inline-block;">IOUT</div> When this indicator is lit, an output current value (effective current: A) is displayed in the data display section.
Constant item indicators	The value set in the constant corresponding to the lit indicator is displayed in the data display section. A new value can be set.



Note In-service item indicators (green indicators):

These items can be monitored or the constant for each item can be set even during operation.

Stopped item indicators (red indicators):

Constants for these items can be set only when the Inverter is stopped. In this display, the direction of motor rotation is displayed during operation.

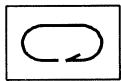
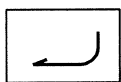
● Operation Keys

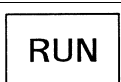
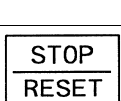
	Mode Key	Press this key to switch between monitor item indicators and constant item indicators.
	Enter Key	Press this key to register the value set in a constant.
	Increment Key	Press this key to increase a constant no. or the value of a constant.
	Decrement Key	Press this key to decrease a constant no. or the value of a constant.
	RUN Key	Press this key to start the Inverter. (This key is valid only when Digital Operator run mode is selected and all indicators in the stopped item indicators are not lit.)
	STOP/RESET Key	Press this key to stop the Inverter. (This key is valid only when Digital Operator run mode is selected.) Also, press this key to reset the Inverter when an error has occurred.

Note When the constant n01 is set to “0,” no items other than FREF and n01 can be set. If settings cannot be changed using the operation keys, set n01 to “1.”

4-2-2 Outline of Operation

■ Switching Data Display during Operation

Press the Mode Key to switch data display.
 During operation, only the items in the in-service item indicators section can be monitored and the constants for these items can be set.
 If the power is turned off when the FOUT or IOOUT indicator is lit, the same indicator lights up next time the power is turned on. Otherwise, the FREF indicator always lights up.

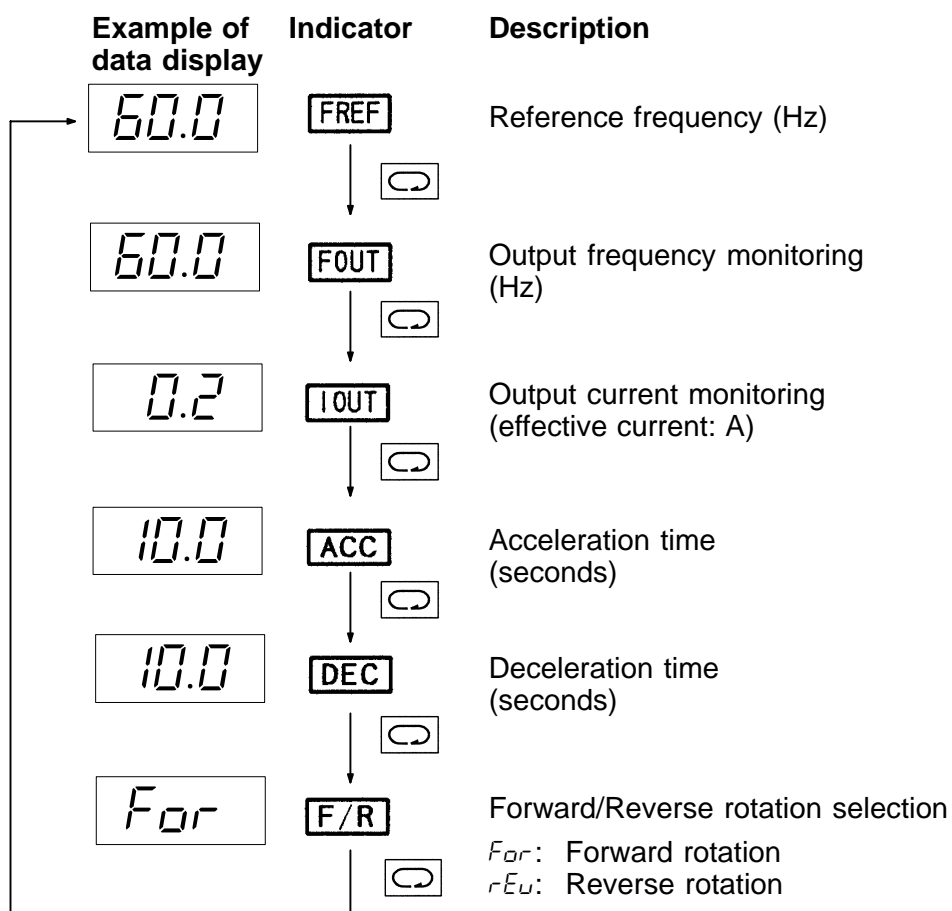

■ Switching Data Display when Inverter is Stopped



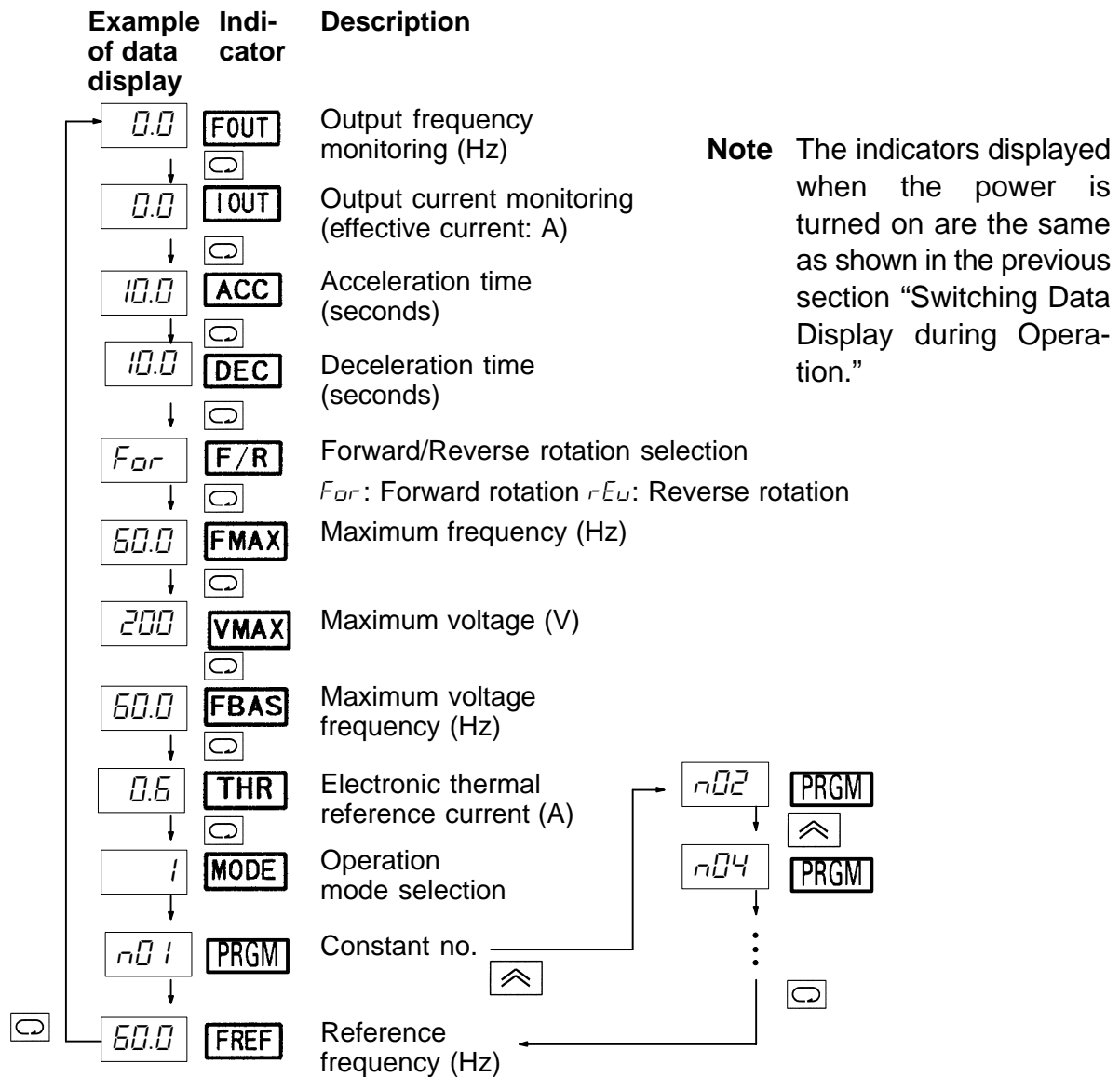



Press the Mode Key to switch data display.
 When the Inverter is stopped, all items can be monitored and the constant for each item can be set.

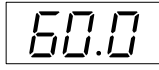

■ Monitor Display

The 3G3EV allows the user to monitor the reference frequency, output frequency, output current, and the direction of rotation.

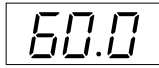
● Operation Method

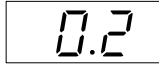
Key operation	Indicator	Example of data display	Description
			Press the Mode Key until the FREF indicator lights up. The reference frequency (Hz) is displayed.
			Press the Mode Key. The output frequency (Hz) is displayed.
			Press the Mode Key. The output current value (effective current: A) is displayed.

Note 1. The direction of rotation can be always monitored during operation. The indicators in the lower two rows of the display section flash indicating the direction of rotation. The indicator flashing speed varies according to the speed of rotation.

Indicator flashing sequence during forward rotation

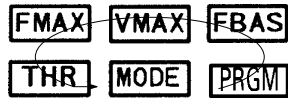

The indicators flash counterclockwise when the motor rotates in the forward direction.

Note 2. The constant item indicators section has the F/R indicator, but this indicator is used to indicate a command when the Inverter is operated with the Digital Operator.

4-2-3 Setting Constants







The 3G3EV (Standard Model) allows the user to set 18 different constants. The constants for basic operations are allocated to dedicated indicators, so the user need not refer to the constant nos. The constants allocated to dedicated indicators can be also set by lighting the PRGM indicator. Note that the operation methods using dedicated indicators and the PRGM indicator are different.

■ Setting Constants

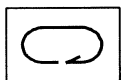
● Setting Constants Using a Dedicated Indicator

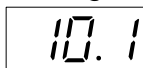
Example:

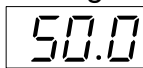
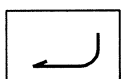
Changing acceleration time from 10 seconds to 50 seconds.

Key operation	Indicator	Example of data display	Explanation
	ACC		Press the Mode Key until the ACC indicator lights up.
	ACC	Flashing 	Press the Increment Key. The data display section flashes (indicating that the data is yet to be registered).
	ACC	Flashing 	Press the Increment Key until "50.0" appears in the data display section. Holding down the key changes data quickly.
	ACC		Press the Enter Key to complete the setting procedure.

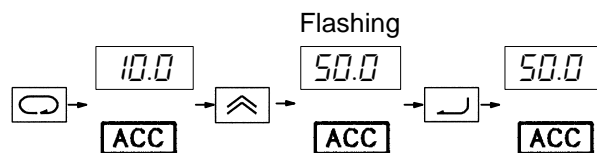











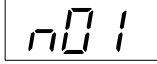

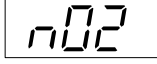
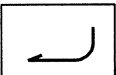
Note If the new data is not to be registered, press the Mode Key instead of the Enter Key. The new data becomes invalid and the next item is displayed.

● Setting Constants Using the PRGM Indicator

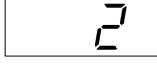
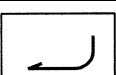
Example:

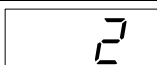
Changing the value of constant no. 02 (operation mode selection) to “2.”

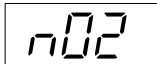
Key operation	Indicator	Example of data display	Explanation
			Press the Mode Key until the PRGM indicator lights up.
			Press the Increment Key. “n02” appears in the data display section.
			Press the Enter Key. The value of constant no. 02 is displayed.
		Flashing 	Change the value to “2” by pressing the Increment Key. The data display section flashes (indicating that the value is yet to be registered).
			Press the Enter Key. The data display section stops flashing.
			After approximately 0.5 second, the data display section returns to the constant no. display (“n02”).

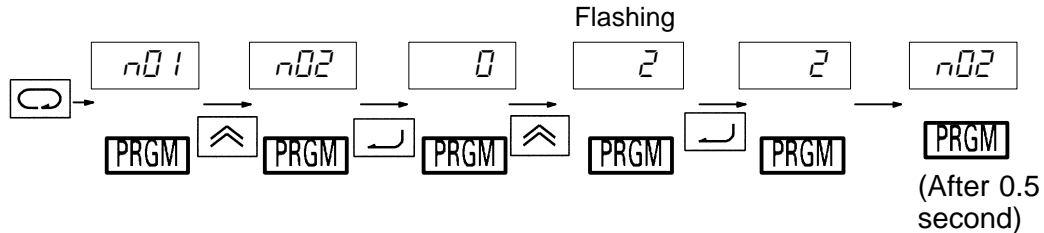

Note 1. If the new data is not to be registered, press the Mode Key instead of the Enter Key. The new data becomes invalid and the constant no. display (“n02”) is returned.

Note 2. Holding down the Increment Key or Decrement Key changes data quickly.

■ List of Constants

Constant no.	Dedicated indicator	Description	Setting range	Factory setting
n01		Constant write-inhibit selection/constant initialization	0, 1, 8, 9	1
n02	MODE	Operation mode selection	0 to 5	0
n03		Interruption mode selection	0, 1	0
n04	F/R	Forward/reverse rotation selection	For, rEv	For
n06		Multi-function input selection	0 to 4	1
n09		Multi-function output selection	0, 1, 2	1
n11	FREF	Frequency reference 1	0.0 to 400	6.0 (Hz)
n12	FREF	Frequency reference 2	0.0 to 400	0.0 (Hz)
n20	ACC	Acceleration time	0.0 to 999	10.0 (seconds)
n21	DEC	Deceleration time	0.0 to 999	10.0 (seconds)
n24	FMAX	Maximum frequency	50.0 to 400	60.0 (Hz)
n25	VMAX	Maximum voltage	1 to 255 (see note 1)	200 (V) (see note 1)
n26	FBAS	Maximum voltage frequency	1.6 to 400	60.0 (Hz)
n31	THR	Electronic thermal reference current	0.0 to see note 2	See note 2
n33		Stall prevention during deceleration	0, 1	0
n36		Operation after recovery from power interruption	0, 1, 2	0
n37		Carrier frequency	1, 2, 3, 4 (see note 3)	4 (see note 4)
n39		Frequency reference gain	0.10 to 2.55	1.00
n40		Frequency reference bias	-99 to 99	0 (%)
n61		Stop Key selection	0, 1	0
n64		Operator's frequency setting method	0, 1	0
n68		Error history	(Display only)	

Note 1. The upper limit of the setting range and the factory setting for the 400-VAC class are double the above values.

Note 2. The setting range and factory setting for n31 (electronic thermal reference current) depend on the Inverter model. For details, refer to *page 4-19*. Normally, set the rated motor amperage in n31.

Note 3. The setting range for the 400-VAC models is “1 to 5.”

Note 4. The factory setting for the 3G3EV-A4015-CUE is “3.”

Note 5. Displaying the constant no. corresponding to an indicator in the “Dedicated indicator” column lights the indicator.

Note 6. Constant no. 02 (n02) and subsequent constants can be set only when constant no. 01 (n01) is set to 1.

Constants in the shaded areas in the above table may not be usable depending on the PROM number (software version).

Constant no.	PROM no. (software version)		
	199 or lower	200	220 or higher
n03	No	Yes	Yes
n39	Setting range: 0.10 to 2.00	Setting range: 0.10 to 2.00	Setting range: 0.10 to 2.55
n61	No	Yes	Yes
n64	No	No	Yes

Note “Yes” indicates that the constant can be set.

“No” indicates that the constant cannot be set.

■ Details of Each Constant

n01	Constant Write-Inhibit Selection/Constant Initialization		
Setting range	0, 1, 8, 9	Factory setting	1

One of the following four values can be selected:

Value	Description
0	Only n01 can be set.
1	Constants n01 to n68 can be displayed and set.
8	All constants are returned to factory settings.
9	The Inverter is initialized in 3-wire sequence mode.

Note 1. If other constants are to be set, always set “1” in n01.

Note 2. Setting “9” (3-wire sequence mode) in n01 allows the user to start and stop the Inverter with automatic recovery type push-button switches.

Example of 3-wire Sequence Mode

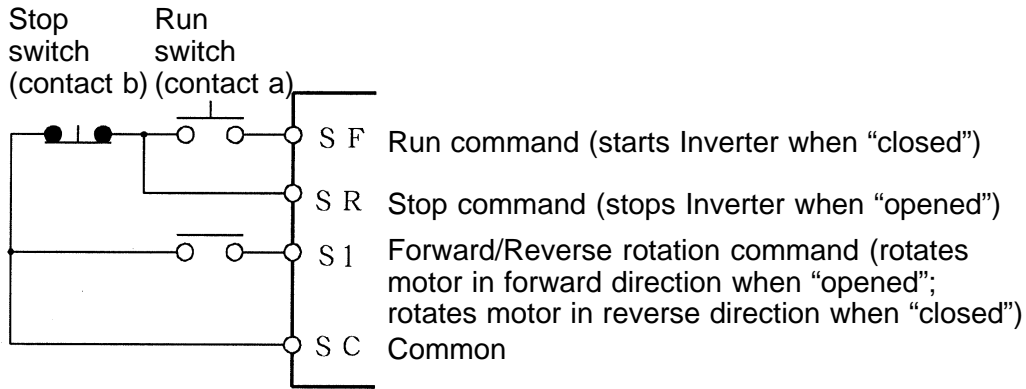

Example of Operation

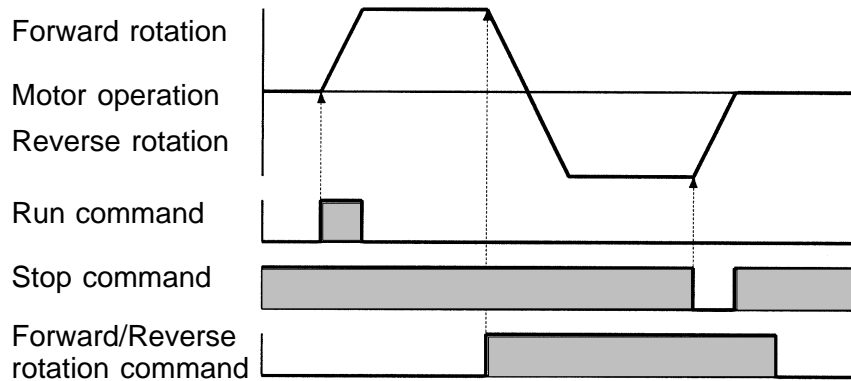

n02	MODE Operation Mode Selection
Setting range	0 to 5
Factory setting	0

This constant is used to specify whether the Inverter is to be operated with a Digital Operator or external signals.

Value	Run command	Frequency reference	DIP switch setting
0	Digital Operator	Digital Operator (n11)	OFF
1	Control terminal	Digital Operator (n11)	OFF
2	Digital Operator	Control terminal (voltage input)	OFF
3	Control terminal	Control terminal (voltage input)	OFF
4	Digital Operator	Control terminal (amperage input)	ON
5	Control terminal	Control terminal (amperage input)	ON

Note 1. The above setting operation can be performed when constant no. 02 is selected. This operation is also possible when the dedicated indicator (“MODE”) is lit.

Note 2. The DIP switch is located inside the Inverter. Use this switch to change the setting when frequency references are to be input in terms of amperage (4 to 20 mA). For details, refer to *Section 7-2 Frequency Reference by Amperage Input*. For voltage input, never set the DIP switch to ON. Doing so may damage the equipment.

n03		Interruption Mode Selection	
Setting range	0, 1	Factory setting	0

This constant is used to specify the interruption mode when the STOP/RESET Key is pressed or the operation command is OFF.

Value	Description
0	Frequency deceleration stop
1	Free running

Example of Frequency Deceleration Stop

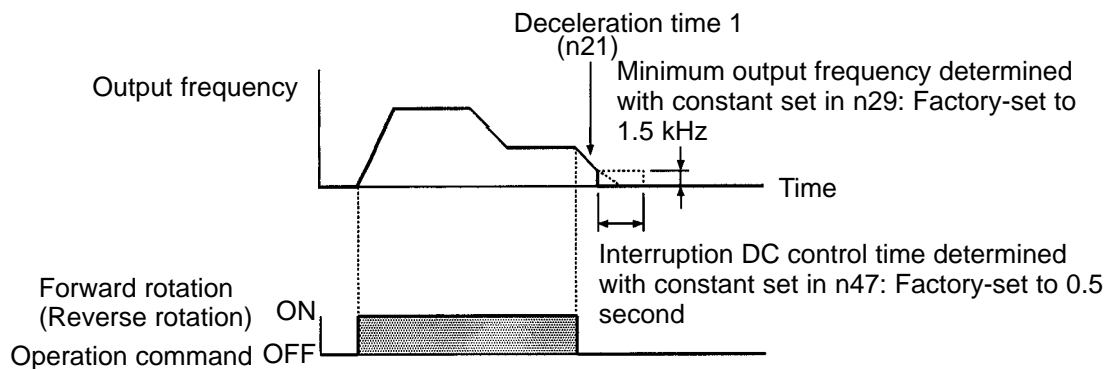

Example of Free Running

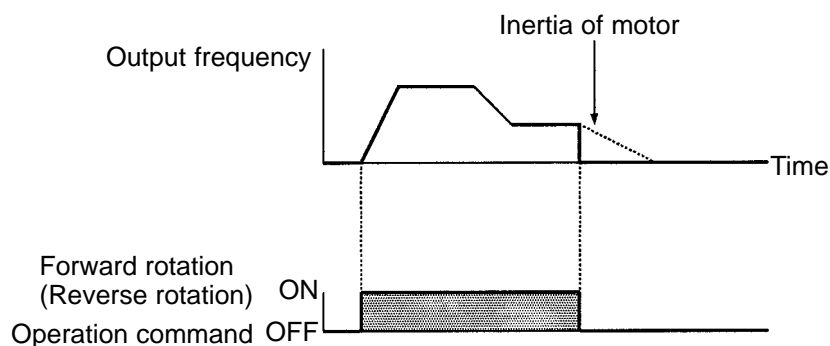

Note This constant is available for models with a PROM number (software version) of “200” or higher.

n04		F/R Forward/Reverse Rotation Selection	
Setting range	<i>F_{OR}</i> , <i>rE_U</i>	Factory setting	<i>F_{OR}</i> (forward rotation)

This constant is used to specify the direction of motor rotation when the Inverter is operated with the Digital Operator.

Value	Description
<i>F_{OR}</i>	Forward rotation
<i>rE_U</i>	Reverse rotation

Note 1. While the Inverter is being operated with the Digital Operator, the direction of motor rotation can be changed by lighting the F/R indicator with the Mode Key first, pressing the Increment or Decrement Key to change the setting, then pressing the Enter Key.

Note 2. The direction (forward/reverse) of motor rotation depends on the motor model used. Refer to the instruction manual for the motor.

n06		Multi-Function Input Selection	
Setting range	0 to 4	Factory setting	1

One of the following values can be selected for the multi-function input (S1) function:

Value	Description
0	Forward/reverse rotation command (3-wire sequence)
1	Fault reset (fault reset when ON)
2	External fault (contact a: external fault when ON)
3	External fault (contact b: external fault when OFF)
4	Multi-step speed command (frequency reference 2 when ON)

n09		Multi-Function Output Selection	
Setting range	0, 1, 2	Factory setting	1

One of the following three values can be specified for the multi-function contact output (MA and MB) function. When the Inverter enters the state corresponding to the specified value, MA is turned on and MB is turned off.

Value	Description
0	Fault occurrence
1	Operation in progress (frequency reference is being output)
2	Frequency matching (see note)

Note MA is turned on when the difference between the reference frequency and the output frequency falls within 2 Hz. MA is turned off when the difference exceeds ± 4 Hz.

Example of Operation

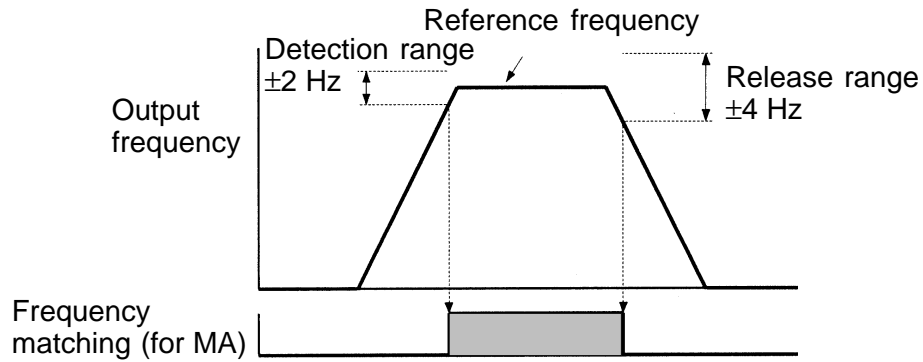

n11	FREF Frequency Reference 1		
Setting range	0.0 to 400 (Hz)	Factory setting	6.0 (Hz)
n12	FREF Frequency Reference 2		
Setting range	0.0 to 400 (Hz)	Factory setting	0.0 (Hz)

- These constants are used to set reference frequency values.
- The unit of setting is as follows:
 0.0 to 99.9 (Hz): 0.1 (Hz)
 100 to 400 (Hz): 1 (Hz)
- The reference frequency value can be changed even during operation. To change the reference frequency value when the Inverter is being operated with the Digital Operator, light the FREF indicator with the Mode Key first, press the Increment or Decrement Key to change the value, then press the Enter Key.
- If one of values 2 to 5 is set in n02 (operation mode selection), the n11 setting is disregarded and control input (voltage or current) becomes valid.
- When using n12 (frequency reference 2), always set “4” (multi-step speed command) in n06 (multi-function input selection). The multi-step speed command is always valid regardless of the n02 setting.
- If the n12 setting is to be changed during operation, perform the above procedure when the multi-step speed command (S1) is ON.

Example of Multi-Step Speed Operation

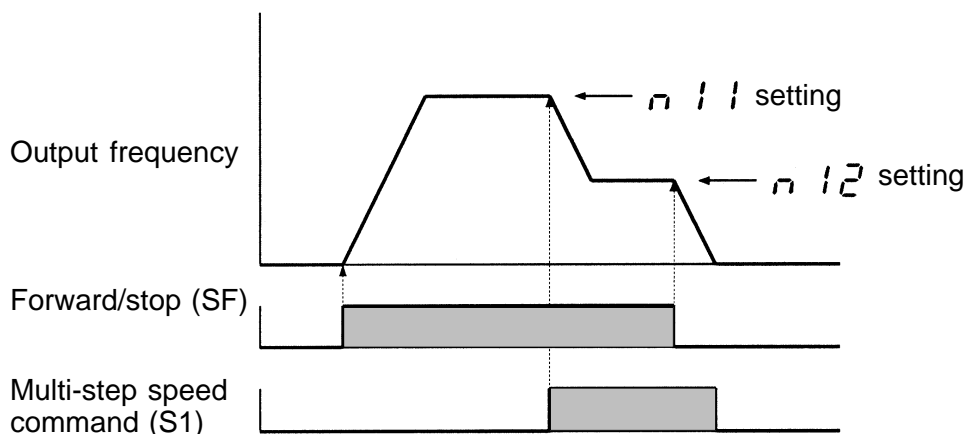

n20	ACC Acceleration Time		
Setting range	0.0 to 999 (seconds)	Factory setting	10.0 (seconds)

n21	DEC Deceleration time		
Setting range	0.0 to 999 (seconds)	Factory setting	10.0 (seconds)

- These constants are used to set acceleration time (required to increase the output frequency from the stopped state to the maximum frequency) and deceleration time (required to decrease the output frequency from the maximum frequency to the stopped state).

(Set the maximum frequency in n24.)

- The unit of setting is as follows:
 0.0 to 99.9 (seconds): 0.1 (second)
 100 to 999 (seconds): 1 (second)
- Acceleration and deceleration times can be changed even during operation. If, for example, acceleration time is to be changed, light the ACC indicator with the Mode Key first, press the Increment or Decrement Key to change the value, then press the Enter Key. Deceleration time can be also changed in the same way. (Light the DEC indicator before changing the deceleration time.)

These constant settings are always valid regardless of whether the Inverter is operated with the Digital Operator or control input.

Explanation of n20 and n21 Settings

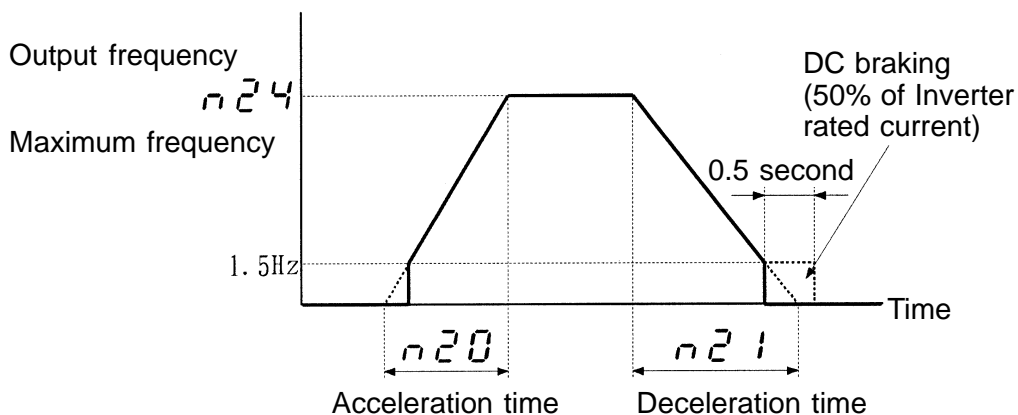

n24	FMAX Maximum Frequency		
Setting range	50.0 to 400 (Hz)	Factory setting	60.0 (Hz)
Unit of setting	50.0 to 99.9 (Hz) : 0.1 (Hz) 100 to 400 (Hz) : 1 (Hz)		

n25	VMAX Maximum Voltage		
Setting range	1 to 255 (510) (V)	Factory setting	200 (400) (V)
Unit of setting	1 (V)		

n26	FBAS Maximum Voltage Frequency (Basic Frequency)		
Setting range	1.6 to 400 (Hz)	Factory setting	60.0 (Hz)
Unit of setting	1.6 to 99.9 (Hz) : 0.1 (Hz) 100 to 400 (Hz) : 1 (Hz)		

Note The values in parentheses are for the 400-VAC class.

- These three constants are used to set a V/f pattern.
- Check the motor specifications and set each constant as follows:
 n24: Maximum frequency or rated frequency
 n25: Rated voltage
 n26: Rated frequency
- The value set in n24 (maximum frequency) must be equal to or greater than the value set in n26 (maximum voltage frequency). Otherwise, an error will result.

Explanation of n24, n25, and n26 Settings

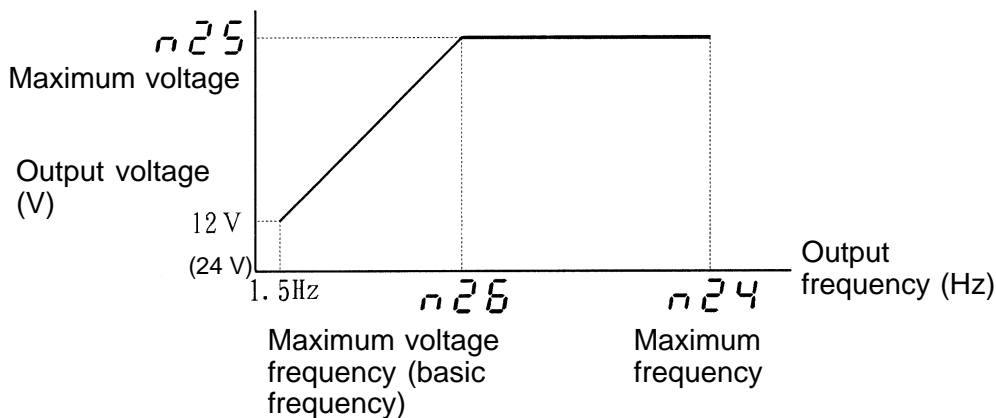

n31	THR Electronic Thermal Reference Current		
Setting range	0.0 to (see note 1) (A)	Factory setting	See note 2
Unit of setting	0.1 (A)		

- This constant is used to set an electronic thermal reference value to protect the motor from overheating.
Set the rated motor amperage in this constant.
- If 0.0 is set in this constant, “no thermal protection” is assumed, so motor overload will not be detected.
- The setting range and factory setting for this constant are as follows:

Note 1. This can be set to a maximum of 120% of the Inverter rated current.

Note 2. Set to the normal rated current of the maximum applicable motor.

n33	Stall Prevention during Deceleration		
Setting range	0, 1	Factory setting	0

This constant is used to select the action to prevent overvoltage during deceleration.

Value	Description
0	Stall prevention during deceleration
1	No stall prevention during deceleration

Note 1. If a braking resistor is to be connected, always set “1” (no stall prevention during deceleration) in this constant.

Note 2. If “0” (stall prevention during deceleration) is set in this constant, deceleration time will be automatically lengthened to prevent overvoltage.

Explanation of Stall Prevention during Deceleration

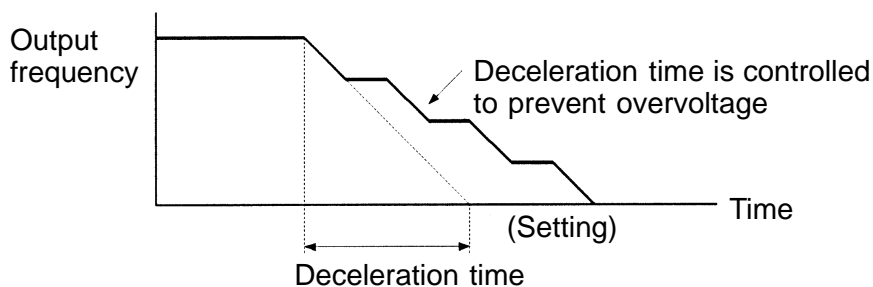

n36	Operation after Recovery from Power Interruption		
Setting range	0, 1, 2	Factory setting	0

This constant is used to select the processing to be performed after recovery from an instantaneous power interruption.

Value	Description
0	Discontinues operation.
1	Continues operation only if power interruption is within 0.5 second.
2	Continues operation unconditionally (with no error output).

Note If “1” or “2” is selected to continue operation, the Inverter automatically searches the motor speed (even when the motor is in a free-running state) and continues smooth operation. This function is called the speed search function.

Explanation of Speed Search Function

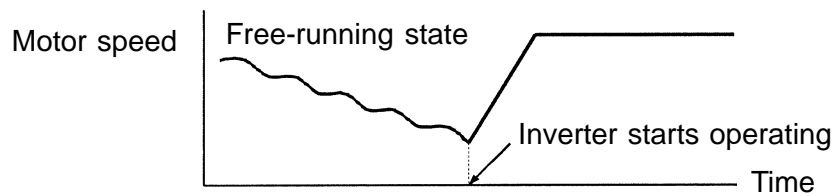

n37	Carrier Frequency		
Setting range	1, 2, 3, 4 (see note 1)	Factory setting	4 (10 kHz) (see note 2)

This constant is used to set a pulse-width-modulated (PWM) carrier frequency.

Value	Carrier frequency
1	2.5 (kHz)
2	5 (kHz)
3	7.5 (kHz)
4	10 (kHz)
5	12.5 (kHz)

Note As the cable between the Inverter and the motor becomes longer, a high-frequency leakage current from the cable increases, causing the Inverter output current to increase as well. This may also affect peripheral devices. To prevent this, adjust the carrier frequency according to the following standards:

- Cable length of 50 meters or less: 10 kHz or less
- Cable length of 50 to 100 meters: 5 kHz or less

Note 1. The setting range for the 400-VAC class is “1 to 5.”

Note 2. The factory setting for the 3G3EV-A4015-CUE is “3.”

Note 3. With the 400-VAC class, the continuous output current cannot be used to 100% of the rated value if the constant is set to “5” for Inverters of 0.75 kW or less or if it is set to “4” or “5” for an Inverter of 1.5 kW.

Set the constant so that the continuous output current does not exceed the values shown in the following tables.

400-VAC Inverters of 0.75 kW or Less

Carrier frequency set value	Max. continuous output current
1 to 4	Up to 100% of the rated output
5	Up to 90% of the rated output

400-VAC Inverter of 1.5 kW

Carrier frequency set value	Max. continuous output current
1 to 3	Up to 100% of the rated output
4	Up to 85% of the rated output
5	Up to 75% of the rated output

n39 Frequency Reference Gain			
Setting range	0.10 to 2.55 (times)	Factory setting	1.00 (times)
Unit of setting	0.01 (times)		

n40 Frequency Reference Bias			
Setting range	-99 to 99 (%)	Factory setting	0 (%)
Unit of setting	1 (%)		

- These constants are used to set the relationship between analog voltage and reference frequencies when frequency references are input through control terminals FR and FC.
- Frequency reference gain (n39): Specify the input voltage corresponding to the maximum frequency (n24) as a multiple of 10 V.
- Frequency reference bias (n40): Specify the reference frequency corresponding to input voltage 0 V as a percentage of the maximum frequency (n24).

Explanation of Frequency Reference Gain and Bias

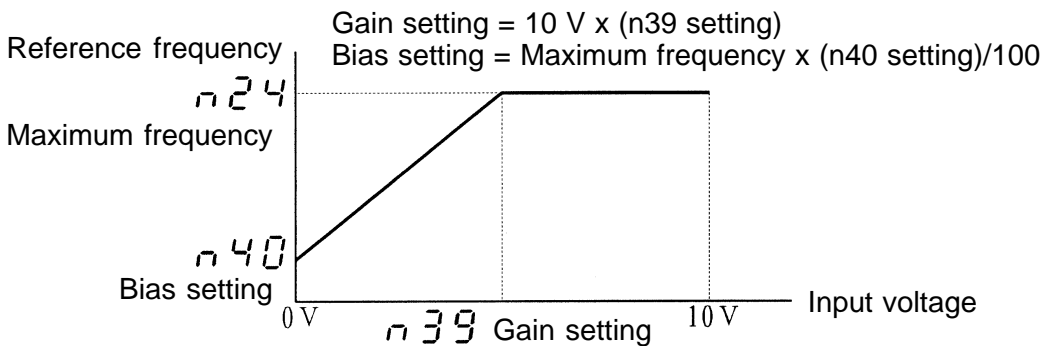

Example of Setting:

Operating the Inverter so that the Maximum Frequency is Reached when the Voltage Increases from 0 to 5 V

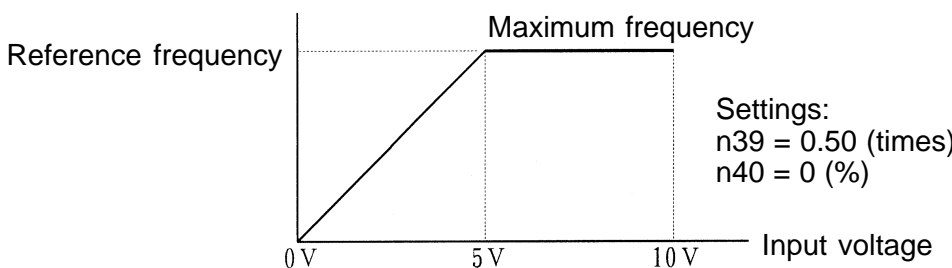

<i>n51</i>	Stop Key Selection		
Setting range	0, 1	Factory setting	0

- When inputting Inverter operation from the control terminals, the Stop Key on the Digital Operator can be set to “enabled” or “disabled.”

Value	Description
0	Stop Key enabled
1	Stop Key disabled

Note 1. When operating the Inverter from the Digital Operator, the Stop Key is always enabled irrespective of its setting.

Note 2. This constant is available for models with a PROM number (software version) of “200” or higher.

<i>n54</i>	Operator’s Frequency Setting Method		
Setting range	0, 1	Factory setting	0

- Used for setting the frequency from the Digital Operator.
- Select the Enter Key operation when setting the frequency command from the Digital Operator.

Value	Description
0	Enter Key required for changing frequency
1	Enter Key not required for changing frequency (may be changed using Increment and Decrement Keys.)

<i>n58</i>	Error History
This constant can only be displayed. It cannot be set.	

- Information about the last error is recorded in this constant. Use this information for troubleshooting purposes.
- The display format is as follows:

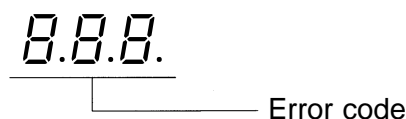

Note This constant is available for models with a PROM number (software version) of “220” or higher.

- Recorded are Inverter errors and other errors that actuate a protective mechanism. Warning (automatically recovered error) is not recorded.
- If no error has occurred, the indicator is not lit.
- All error codes are listed below.

Error code	Description	Error category
<i>oC</i>	Overcurrent (OC)	Errors that actuate protective mechanism
<i>ou</i>	Main circuit overvoltage (OV)	
<i>Uu1</i>	Main circuit undervoltage (UV1)	
<i>Uu2</i>	Control power supply fault (UV2)	
<i>oH</i>	Radiation fin overheated (OH)	
<i>oL1</i>	Motor overload (OL1)	
<i>oL2</i>	Inverter overload (OL2)	
<i>EF1</i>	External fault (EF1)	
<i>FD0</i>	Initial memory error	Inverter errors
<i>FD1</i>	ROM error	
<i>FD4</i>	Constant error	
<i>FD5</i>	A/D converter error	
<i>FD6</i>	Option error	

4-3 Test Run

After wiring is complete, perform a test run of the Inverter as follows. First, start the motor through the Digital Operator without connecting the motor to the mechanical system. Next, connect the motor to the mechanical system and perform a test run. Finally, operate the controller to make sure that the sequence of operations is correct.

This section only describes how to perform a test run using the Digital Operator.

4-3-1 Checking Wiring

- Check that terminals R, S, and T receive power supply.

200-VAC Class

Three-phase input: 200 to 230 VAC, 50/60 Hz

Single-phase input: 200 to 240 VAC, 50/60 Hz (terminal R and S)

(Single-phase input is only applicable to 3G3EV-AB□□□.)

400-VAC Class



Three-phase input: 380 to 460 VAC, 50/60 Hz

- Check that terminals U, V, and W are correctly connected to the motor power cables.
- Do not connect the mechanical system to the motor. (The motor must be in no-load status.)
- If signal lines are connected to control terminals, turn terminals SF and SR off.

4-3-2 Turning Power On and Checking Indicator Display

- Check that the ALARM indicator is not lit.
- Check that the RUN indicator is flashing.

4-3-3 Initializing Constants

PRGM  

- Set “8” or “9” (3-wire sequence mode) in constant no. 01 to initialize constants.

4-3-4 Setting a V/f Pattern

FMAX **VMAX** **FBAS**

- Set the maximum frequency (“FMAX” or constant no. 24), maximum voltage (“VMAX” or constant no. 25), and maximum voltage frequency (“FBAS” or constant no. 26) according to the operating conditions.

4-3-5 Setting Rated Motor Amperage

THR

- Set the rated motor amperage in constant no. 31 (electronic thermal reference current) or with the “THR” indicator lit.

4-3-6 Setting the Reference Frequency

FREF

- Set the frequency corresponding to the motor speed in constant no. 11 (frequency reference 1) or with the “FREF” indicator lit.

4-3-7 Operating the Inverter with the Digital Operator

- Press the RUN Key to rotate the motor in the forward direction. (If the PRGM indicator is lit in the constant item indicators section, press the Mode Key once to light the FREF indicator. If a red indicator in the stopped item indicators section is lit, the run command cannot be accepted.)
- Check that the motor rotates smoothly without making noise.
- Check that the direction of rotation is correct.

4-3-8 Checking Output Frequency and Amperage

FOUT IOUT

- Light the FOUT indicator (output frequency monitor) and make sure that the displayed value matches the reference frequency.
- Light the IOUT indicator (output current monitor) and check for overcurrent.

4-3-9 Checking Operation during Reverse Rotation

F/R

- Rotate the motor in the reverse direction and check the same items as above.

4-3-10 Checking Operation with Mechanical System Connected

- Press the STOP/RESET Key to stop the motor.
- Connect the mechanical system to the motor and check the same items as above.

4-3-11 Checking Operation Performed by Controller

MODE

- Light the MODE indicator and set the actual operation mode.
- Operate the Inverter with the controller, check for noise resulting from mechanical resonance, and check that the sequence of operations is correct.

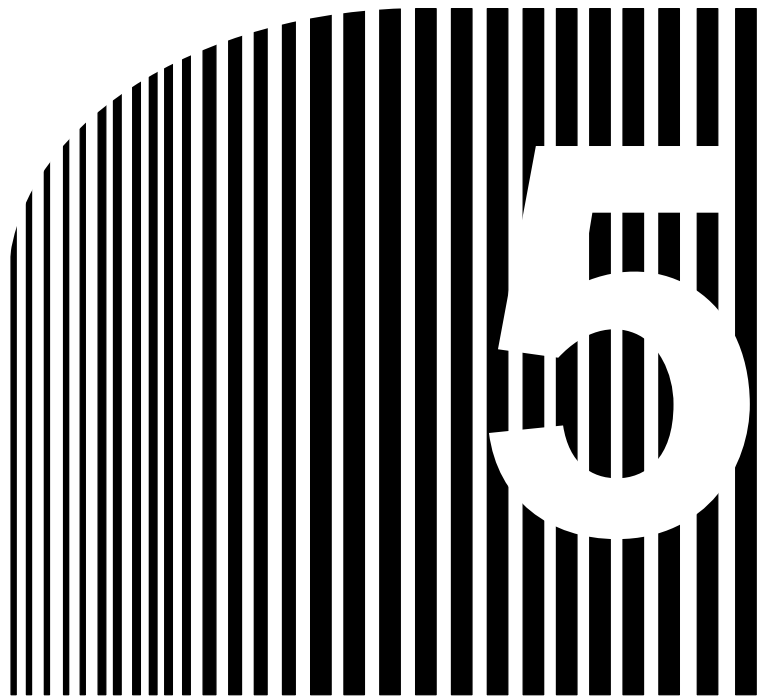

Chapter 5

• Operation •

5-1 Protective and Diagnostic Functions

5-2 Troubleshooting

5-3 Maintenance and Inspection

5-1 Protective and Diagnostic Functions

The 3G3EV has excellent protective and diagnostic functions. The RUN and ALARM indicators on the front panel indicate the current Inverter status, and the data display section also displays information about an error that has occurred. These functions therefore enable the user to take the appropriate actions to correct most errors.

■ List of Error Codes

Inverter status	Indicator		Data display	Description
	RUN	ALARM		
Normal	Flashes	Not lit	---	Ready to run
	Lit	Not lit	---	Normal operation in progress
Warning	Flashes	Flashes	<i>EF</i>	Simultaneous input of forward and reverse rotation commands
	Lit	Flashes	<i>Uu</i>	Main circuit undervoltage (UV)
			<i>ou</i>	Main circuit overvoltage (OV)
			<i>oH</i>	Radiation fin overheated (OH)
		<i>SFP</i>	Digital Operator stopped (STP)	
Protective mechanism actuated	Not lit	Lit	<i>oC</i>	Overcurrent (OC)
			<i>ou</i>	Main circuit overvoltage (OV)
			<i>Uu1</i>	Main circuit undervoltage (UV1)
			<i>Uu2</i>	Control power supply fault (UV2)
			<i>oH</i>	Radiation fin overheated (OH)
			<i>oL1</i>	Motor overload (OL1)
			<i>oL2</i>	Inverter overload (OL2)
Inverter error	Not lit	Lit	<i>FD0</i>	Initial memory error
			<i>FD1</i>	ROM error
			<i>FD4</i>	Constant error
			<i>FD5</i>	A/D converter error
			<i>FD6</i>	Option error
	Not lit	Not lit	(Not lit)	Control circuit error

■ **Data Display and Action to be Taken when Warning Status Arises**

The ALARM indicator flashes when warning status arises. The data display section also flashes.

When warning status arises, no error code is output.

Eliminating the cause recovers the system automatically.

Data display	Description	Action
<i>EF</i> flashing	<p>Simultaneous input of forward and reverse rotation commands</p> <p>Forward and reverse rotation commands were simultaneously input for 0.5 second or more. The Inverter decelerates and stops the motor.</p>	<ul style="list-style-type: none"> • Review the sequence.
<i>Uu</i> flashing	<p>Main circuit undervoltage (UV)</p> <p>The DC voltage of the main circuit dropped below the low-voltage detection level when the Inverter was stopped.</p>	<ul style="list-style-type: none"> • Check the power voltage. • Check the power input line for disconnection. • Check the terminal block screws for looseness.
<i>ou</i> flashing	<p>Main circuit overvoltage (OV)</p> <p>The DC voltage of the main circuit exceeded the overvoltage detection level when the Inverter was stopped.</p>	<ul style="list-style-type: none"> • Check the power voltage.
<i>oH</i> flashing	<p>Radiation fin overheated (OH)</p> <p>The radiation fin overheated when the Inverter was stopped.</p>	<ul style="list-style-type: none"> • Check the ambient temperature. • Install a cooling fan or air conditioner.
<i>STP</i> flashing	<p>Digital Operator stopped (STP)</p> <p>The STOP/RESET Key on the Digital Operator was pressed while the Inverter was being operated using control circuit terminals SF and SR. The Inverter decelerates and stops the motor.</p>	<ul style="list-style-type: none"> • Open both SF and SR.

■ Data Display and Action to be Taken when Protective Mechanism is Actuated

The ALARM indicator lights up when the protective mechanism is actuated. In this event, Inverter output is shut off, and the motor coasts to a stop.

Check the cause of the error, take the necessary action, and perform fault reset or turn the power off, then on.

Data display	Description	Cause and action
$\square \overline{I}$	<p>Overcurrent (OC) The Inverter output current instantaneously exceeded 250% of the rated amperage.</p>	<ul style="list-style-type: none"> • The output side of the Inverter is shorted or grounded. • Load inertia is excessive. • The acceleration and deceleration time settings are too short. • A special motor is used. • The motor was started during free running. • The magnetic contactor on the output side of the Inverter was opened and closed. <p style="text-align: center;">↓</p> <ul style="list-style-type: none"> • Determine the cause of the error, take the necessary action, and reset the system.
$\square \overline{U}$	<p>Main circuit overvoltage (OV) Because regenerative energy from the motor was excessive, the DC voltage of the main circuit exceeded approximately 410 V. (400-VAC Class, 820 V)</p>	<ul style="list-style-type: none"> • The deceleration time setting is too short. <p style="text-align: center;">↓</p> <ul style="list-style-type: none"> • Increase the deceleration time. • Connect a braking resistor (or braking resistor unit). <p style="text-align: center;">↓</p> <ul style="list-style-type: none"> • The regenerative energy becomes excessive when returning from the overshoot during acceleration. <p style="text-align: center;">↓</p> <ul style="list-style-type: none"> • Connect a braking resistor (or braking resistor unit).

Data display	Description	Cause and action
Uu1	<p>Main circuit undervoltage (UV1)</p> <p>The DC voltage of the main circuit dropped below the specified level. 3G3EV-A2□□□: Approximately 200 V or less 3G3EV-AB□□□: Approximately 160 V or less 3G3EV-A4□□□-CUE: Approximately 400 V or less</p>	<ul style="list-style-type: none"> • The input power voltage dropped. • Open-phase occurred. • An instantaneous power interruption occurred. <p style="text-align: center;">↓</p> <ul style="list-style-type: none"> • Check the power voltage. • Check the power input line for disconnection. • Check the terminal block screws for looseness.
Uu2	<p>Control power supply fault (UV2)</p> <p>A voltage fault occurred in control power supply.</p>	<ul style="list-style-type: none"> • Turn the power off, then on. • If this problem persists, replace the Unit.
oH	<p>Radiation fin overheated (OH)</p> <p>The radiation fin overheated because of ambient temperature rise or Inverter temperature rise due to overload.</p>	<ul style="list-style-type: none"> • Load is excessive. <ul style="list-style-type: none"> ⇒ Reduce the load. • The V/f characteristics are inappropriate. <ul style="list-style-type: none"> ⇒ Reset constant Nos. 24 to 26. • The acceleration/deceleration time or cycle time is too short. <ul style="list-style-type: none"> ⇒ Increase the acceleration/deceleration time or cycle time. • The ambient temperature is too high. <ul style="list-style-type: none"> ⇒ Install a cooling fan or air conditioner.

Data display	Description	Cause and action
OL 1	<p>Motor overload (OL1) The electronic thermal relay actuated the motor overload protection function.</p>	<ul style="list-style-type: none"> • Review the load size, V/f characteristics, acceleration/deceleration time, and cycle time. • Set the rated motor amperage in constant No. 31 (electronic thermal reference current). • The maximum voltage frequency (FBAS) was set too low (V/f characteristics setting error) and caused overcurrent. • Set the maximum voltage frequency to the rated motor frequency. • Operated more than one motor with one Inverter. • Set constant No. 31 (electronic thermal reference current) to "0.0 (A)."
OL 2	<p>Inverter overload (OL2) The electronic thermal relay actuated the Inverter overload protection function.</p>	<ul style="list-style-type: none"> • Review the load size, V/f characteristics, acceleration/deceleration time, and cycle time. • Review the Inverter capacity.
EF 1	<p>External fault (EF1) The Inverter received abnormal input from external circuits.</p>	<ul style="list-style-type: none"> • Review the external circuits. • Review the external sequence. • Check the signal line of multi-function contact input for disconnection.

■ **Data Display and Action to be Taken when Inverter Error Occurs**

The first character of an error code is always “F” when an Inverter error occurs. (However, all indicators are not lit when a control circuit error occurs.)

If an Inverter error occurs, turn the power off, then on. If the problem persists, replace the Unit.

Data display	Description	Action
<i>F00</i>	Initial memory error	<ul style="list-style-type: none"> • Turn the power off, then on. • If the problem persists, replace the Unit.
<i>F01</i>	ROM error	
<i>F04</i>	Constant error	<ul style="list-style-type: none"> • Write down all the constant settings, initialize the constants, and reset the constants. • Turn the power off, then on. • If the problem persists, replace the Unit.
<i>F05</i>	A/D converter error	<ul style="list-style-type: none"> • Turn the power off, then on. • If the problem persists, replace the Unit.
<i>F06</i>	Option error The Digital Operator has an error or faulty contact.	<ul style="list-style-type: none"> • Turn the power off, then reinstall the Digital Operator. • If the problem persists, replace the Unit.
(Not lit)	Control circuit error An error occurred in the control power supply or hardware.	<ul style="list-style-type: none"> • Check the power cables. • Replace the Unit.

5-2 Troubleshooting

If the Inverter or motor does not operate properly when the system is started, constant settings or wiring may be incorrect. In this case, take the appropriate action as described below. (If an error code is displayed, refer to 5-1 *Protective and Diagnostic Functions*.)

5-2-1 Constants Fail to Set

■ *Err* is Displayed in the Data Display Section.

- If an attempt is made to set a value outside the allowable range, *Err* is displayed in the data display section. The value is canceled and the data display section re-displays the original value. For example, this error occurs when:
 - An attempt is made to set a reference frequency value higher than the maximum frequency value.
 - An attempt is made to set a maximum voltage frequency (basic frequency) value higher than the maximum frequency value.

Check the setting range, then set the constant correctly.

■ The Display Does Not Change when the Increment or Decrement Key is Pressed.

- Value “0” is set in n01 (constant write-inhibit selection)
Set “1” in n01.
- The Digital Operator is not connected properly.
Turn the power off. After all indicators on the front panel go off, remove the Digital Operator, then reinstall it.

5-2-2 Motor Fails to Operate

■ The Motor Does Not Operate when the RUN Key on the Digital Operator is Pressed.

- Operation mode was not selected correctly.
If “1,” “3,” or “5” is set in n02, the motor does not operate when the RUN Key on the Digital Operator is pressed.
Always set “0,” “2,” or “4” in n02.

- The reference frequency is too low.

When the reference frequency is less than 1.5 Hz, the Inverter cannot operate. Change the reference frequency to 1.5 Hz or more.

- The sequence input method is wrong.

If the 3-wire sequence input mode is selected as an external terminal function instead of the actual 2-wire sequence input mode, the motor will not run, in which case change the constant or change to the sequence input that matches the constant setting.

■ The Motor Does Not Operate when an External Run Signal is Input.

- Operation mode is selected incorrectly.

If “0,” “2,” or “4” is set in n02, the motor does not operate when a run signal is input. Always set “1,” “3,” or “5” in n02.

- The reference frequency is too low.

When the reference frequency is less than 1.5 Hz, the Inverter does not operate. Change the reference frequency to 1.5 Hz or more.

■ The Motor Stops during Acceleration or when a Load is Connected.

- Load is too high.

The 3G3EV has a stall prevention function and full automatic torque boost function. However, if acceleration or load is too high, the motor response limit will be exceeded. To prevent this, increase acceleration time or reduce load. Motor capacity should be also increased.

5-2-3 Motor Rotates in the Wrong Direction

- The motor output line is connected incorrectly.

If terminals U, V, and W on the Inverter are correctly connected to terminals U, V, and W on the motor, the motor rotates in the forward direction when a forward rotation command is input. Since the forward direction of rotation depends on the motor manufacturer and model, check the motor specifications.

To reverse the direction of rotation, switch the wires of two phases of U, V, and W as shown below.

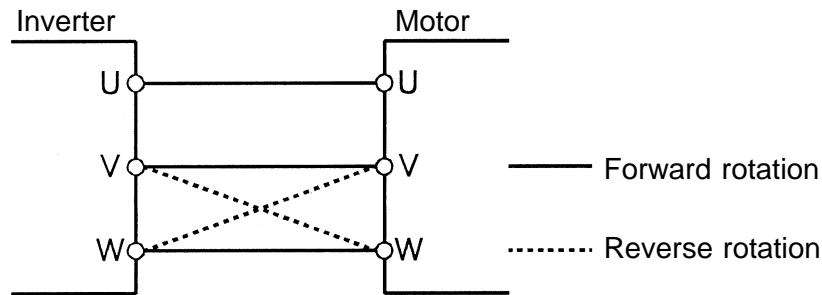

5-2-4 Motor Deceleration is Too Slow

■ Deceleration Time is Too Long Even if a Braking Resistor is Connected.

- Value 0 (stall prevention during deceleration) is set in n33.

When a braking resistor is connected, always set “1” (no stall prevention during deceleration) in n33. If “0” is set, the braking resistor will not be used.

- The deceleration time set in n21 is too long.

Check the deceleration time setting.

- Motor torque is insufficient.

If the constant settings are normal and overvoltage does not occur, motor capacity is insufficient.

Motor capacity should be increased.

5-2-5 Vertical-axis Load Drops when Brakes are Applied

- Sequence is incorrect.

The Inverter remains in DC braking status (50% of the n31 setting) for 0.5 second after deceleration is complete. Modify the sequence so that brakes are applied when the Inverter enters DC braking status.

- Brakes are inappropriate.

Always use control brakes, not holding brakes.

5-2-6 Motor Burns

- The dielectric strength of the motor is insufficient.

Surge arises when the motor (inductive load) is connected to the output side of the Inverter. Normally, the maximum surge voltage is approximately three times the power voltage. Therefore, the dielectric strength of the motor to be used must be higher than the maximum surge voltage.

It is recommended that motors specifically for Inverters be used, especially for the 400-VAC-class Inverters.

5-2-7 Controller Receives Noise when Inverter is Started

- Noise derives from Inverter switching.

Take the following actions to prevent noise:

- Reduce the carrier frequency of the Inverter.

The number of internal switching times is reduced, so noise can be reduced to some extent.

- Improve the frame ground.

A current generated by internal switching normally leaks into the frame ground. Therefore, connect the ground terminal with a sufficiently thick and short wire of 100 Ω or less.

- Install an input noise filter.

Install an input noise filter (3G3IV-PHF) on the power input side of the Inverter.

- Install an output noise filter.

Install an output noise filter (3G3IV-PLF) on the output side of the Inverter.

- Provide a separate power supply for the sensor.

If the sensor malfunctions, provide a dedicated power supply for the sensor and install a noise filter on the power supply. For the signal line, use a shielded cable.

5-2-8 AM Radio Receives Noise when Inverter is Started

- Noise derives from Inverter switching.

Take the following actions to prevent noise:

- Reduce the carrier frequency of the Inverter.

The number of internal switching times is reduced, so noise can be reduced to some extent.

- Install an input noise filter.
Install an input noise filter (3G3IV-PHF) on the power input side of the Inverter.
- Install an output noise filter.
Install an output noise filter (3G3IV-PLF) on the output side of the Inverter.
- Use metal box and piping.
Metal can block off radio waves. Therefore, enclose the Inverter with a metal (steel) box to prevent radio waves from being emitted from the Inverter.

5-2-9 Ground Fault Interrupter is Actuated when Inverter is Started

- Leakage current flows through the Inverter.
Because switching is performed inside the Inverter, a leakage current flows through the Inverter. This leakage current may actuate the ground fault interrupter, shutting the power off.
Use a ground fault interrupter with a high leakage-current detection value (sensitivity amperage of 200 mA or more, operating time of 0.1 second or more) or the one with high-frequency countermeasures (for Inverter).
Reducing the carrier frequency value is also relatively effective.
Note also that a leakage current increases in proportion to the cable length. Normally, an approximately 5 mA leakage current is generated per meter (cable length).

5-2-10 Mechanical System Makes Noise

- The carrier frequency and the natural frequency of the mechanical system resonates.
Take the following actions:
 - Adjust the carrier frequency.
Adjusting the carrier frequency (n37) may prevent resonance from occurring.
 - Install vibration-proof rubber.
Install vibration-proof rubber on the motor base.

5-2-11 Motor Does Not Operate with EF Warning

- EF Warning (simultaneous input of forward and reverse commands) is a warning alarm that is issued when forward and reverse commands are simultaneously input for longer than 500 ms. Check the Inverter's sequence input.
- The Inverter input may be set to the ON state due to the current leaked in from the control output.

Under the wiring condition shown below, if the control output power supply is lower than 24 VDC or if it is set to OFF, current may flow in the direction shown by the arrows and may operate the Inverter input. In such a case, insert a diode in the A section shown below.

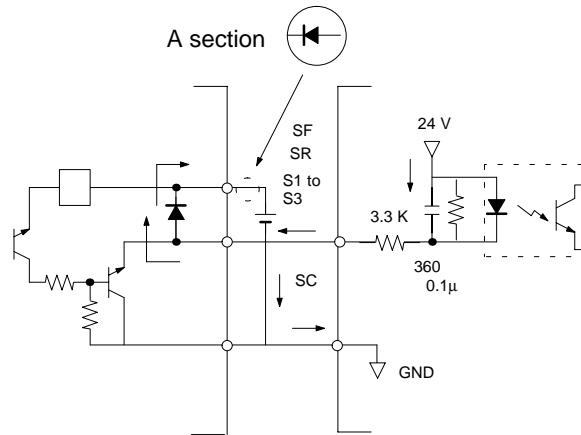

5-3 Maintenance and Inspection

■ Daily Inspection

While the system is operating, check the following items:

- Check the motor for noise.
- Check for abnormal heating.
- Check if the ambient temperature is too high.
- Check if the output current monitor display indicates a higher value than usual.

■ Regular Maintenance

Check the items below during regular maintenance.

Before starting inspection, always turn the power off, then wait at least one minute after all indicators on the front panel go off. Touching terminals immediately after turning the power off may cause an electrical shock.

- Check the terminal block screws for looseness.
- Check if electrically conductive dust or oil mist adheres to the terminal block.
- Check the Inverter set screws for looseness.
- Check if dust or dirt builds up on the heat sink (aluminum portion on the rear of the Unit).
- Check if dust builds up in the air vents.
- Check if the appearance is normal.
- Check if the cooling fan for the control panel operates normally. (Check for noise or abnormal vibration, and also check if the total hours of operation has exceeded the value shown in the specifications.)

■ Regular Parts Maintenance

An Inverter consists of many different parts. It can provide its full performance only when these parts operate normally. Some electronic parts require maintenance depending on the service conditions. To allow the Inverter to operate normally over an extended period of time, always perform regular inspection and parts replacement according to the service life of each part.

Regular inspection intervals vary according to the Inverter installation environment and service conditions.

The maintenance interval for this Inverter is shown below. Use this information as a guide to regular maintenance.

The standard interval for regular maintenance is as follows:

Electrolytic capacitor: Approximately 5 years (8 hours of operation per day)

As for service conditions, it is assumed that the ambient temperature of the Inverter is 40°C, and the Inverter is used under rated operating conditions (rated torque) and is installed as specified in the User's Manual.

To extend maintenance intervals, ambient temperatures should be lowered, and power-on time should be minimized.

Note For the maintenance method, contact your nearest local sales representative.

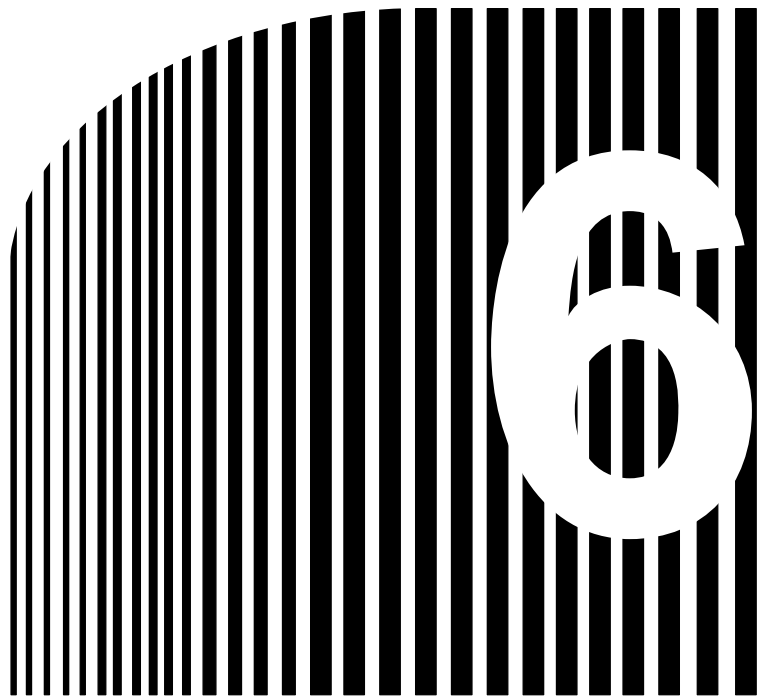

Chapter 6

• Specifications •

6-1 Specifications of Main Unit

6-1 Specifications of Main Unit

■ Rating

Three phase, 200 VAC	Model 3G3EV-		A2001(-□)	A2002(-□)	A2004(-□)	A2007(-□)	A2015(-□)
	Power supply	Rated voltage and frequency	Three-phase, 200 to 230 VAC, 50/60 Hz				
		Allowable voltage fluctuation	-15% to 10 %				
		Allowable frequency fluctuation	±5%				
	Heating value (W)		11.9	18.8	33.2	51.7	71.6
	Weight (kg)		0.5	0.6	0.9	1.3	1.5
Single phase/ Three phase, 200 VAC	Model 3G3EV-		AB001(-□)	AB002(-□)	AB004(-□)	AB007(-□)	AB015(-□)
	Power supply	Rated voltage and frequency	Single-phase, 200 to 240 VAC, 50/60 Hz Three-phase, 200 to 230 VAC, 50/60 Hz				
		Allowable voltage fluctuation	-15% to 10 %				
		Allowable frequency fluctuation	±5%				
	Heating value (W)		12.6	20.3	25.3	55.3	78.4
	Weight (kg)		0.5	0.6	1.3	1.3	2.0
Maximum applicable motor capacity (kW)		0.1	0.2	0.4	0.75	1.5	
Output specifications	Rated output capacity (kVA)		0.3	0.6	1.1	1.9	2.7
	Rated output current (A)		0.8	1.5	3.0	5.0	7.0
	Rated output voltage		Three-phase, 200 to 230 VAC (Corresponds to the input voltage)				
	Maximum output frequency		400 Hz (Parameter setting)				
Cooling method		Self-cooling					

Three phase, 400 VAC	Model 3G3EV-		---	A4002(-□)	A4004(-□)	A4007(-□)	A4015(-□)
	Power supply	Rated voltage and frequency	Three-phase, 380 to 460 VAC, 50/60 Hz				
		Allowable voltage fluctuation	-15% to 10 %				
		Allowable frequency fluctuation	±5%				
	Heating value (W)		---	25.5	34.7	56.0	78.5
Weight (kg)		---	1.0	1.0	1.5	2.0	
Maximum applicable motor capacity (kW)		---	0.2 (0.37)	0.4 (0.55)	0.75 (1.1)	1.5 (1.5)	
Output specifications	Rated output capacity (kVA)	---	0.9	1.4	2.6	3.7	
	Rated output current (A)	---	1.2	1.8	3.4	4.8	
	Rated output voltage	Three-phase, 380 to 460 VAC (Corresponds to the input voltage)					
	Maximum output frequency	400 Hz (Parameter setting)					
Cooling method		Self-cooling					

■ General Specifications

Installation type	Panel mounting
Installation site	Indoor (free from corrosive gases and dust)
Ambient temperature for operation	-10° to 50°C
Humidity	90% or less (no-condensing)
Ambient temperature for storage	-20° to 60°C
Altitude	1,000 m max.
Vibration resistance	Less than 20 Hz: 1G {9.8 m/s ² } or less 20 to 50 Hz: 0.2G {1.96 m/s ² } or less
Cable length between Inverter and motor	100 m max.

■ Control Characteristics

Control method	Sine-wave PWM method (automatic torque boost)
Frequency control range	1.5 to 400 Hz
Frequency accuracy (temperature fluctuation)	Digital command: ±0.01% (-10°C to 50°C) Analog command: ±1% (25 ±10°C)
Frequency setting resolution	Digital command: 0.1 Hz (less than 100 Hz), 1 Hz (100 Hz or more) Analog command: 0.06 Hz (60 Hz)
Frequency output resolution	0.1 Hz (operation resolution)
Overload resistance	1 minute or less when 150% of rated output current is received
Frequency setting signal	0 to 10 VDC (20 kΩ) or 4 to 20 mA (250 Ω) Note This setting can be switched using the internal DIP switch.
Acceleration/Deceleration time	0.0 to 999 seconds (acceleration and deceleration times are set separately)
Braking torque (continuous regenerative braking)	Approximately 20% Note 125% to 220% when braking resistor is externally installed.
Voltage/Frequency characteristics	Simple V/f pattern setting

■ Protection Functions

Motor protection	Electronic thermal protection
Instantaneous overcurrent protection	When 250% of the rated output amperage is exceeded
Overload protection	When 150% of the rated output amperage is exceeded for one minute
Overvoltage protection	Stops the system when DC voltage of the main circuit exceeds approximately 410 V (400-VAC Class approximately 820 V)
Voltage drop protection	3G3EV-A2□□□: Stops the system when voltage drops below approximately 200 V 3G3EV-AB□□□: Stops the system when voltage drops below approximately 160 V 3G3EV-A4□□□: Stops the system when voltage drops below approximately 400 V
Protection from instantaneous power interruption	Stops the system when a power interruption lasts for 15 ms or more. Operation can be continued by setting constant No. 36 as follows: <ul style="list-style-type: none"> • Operation is continued if a power interruption only lasts for approximately 0.5 second or less. • Operation is continued unconditionally.
Radiation fin overheat protection	Detects a fin temperature of 110 ±10°C
Ground protection	Overcurrent level protection

■ Operation Specifications

<p>Control input</p>	<p>Three photocoupler input terminals (24 VDC, 8 mA)</p> <ul style="list-style-type: none"> • Forward/stop [SF] • Reverse/stop [SR] • Multi-function input [S1] (set in constant No. 06) Select either of “fault reset,” “external fault,” and “multi-step speed command.” <p>Note When 3-wire sequence mode (constant No. 01 = “9”) is selected, the terminals become as follows:</p> <ul style="list-style-type: none"> • Run command [SF] • Stop command [SR] • Forward/reverse rotation command [S1]
	<p>One analog input terminal (0 to 10 VDC or 4 to 20 mA)</p> <ul style="list-style-type: none"> • Frequency reference input [Between FC and FR]
<p>Control output</p>	<p>One SPDT relay contact output terminal [MA, MB] (30 VDC and 1A; 250 VAC and 1A)</p> <ul style="list-style-type: none"> • Multi-function contact output (set in constant No. 09) Select either of “fault occurrence,” “operation in progress,” and “frequency matching.”

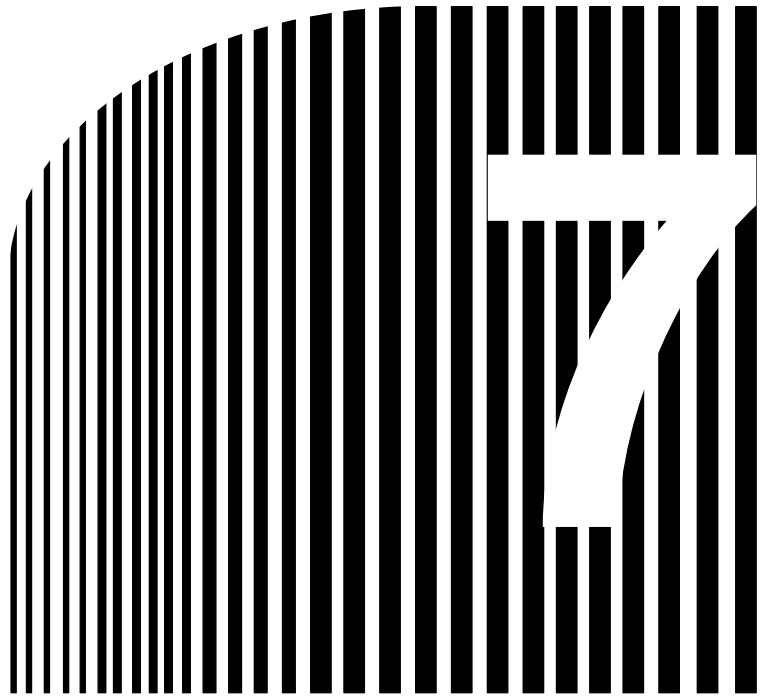

Chapter 7

• Appendix A •

7-1 Notes on Using Inverter for Motor

7-2 Frequency Reference by Amperage Input

7-3 List of Product Models

7-1 Notes on Using Inverter for Motor

■ Using Inverter for Existing Standard Motor

When a standard motor is operated with this Inverter, a power loss is slightly higher than when operated with a commercial power supply.

In addition, cooling effects also decline in the low-speed range, resulting in an increase in the motor temperature. Therefore, motor torque should be reduced in the low speed range.

The figure on the right-hand side shows allowable load characteristics of a standard motor.

If 100% torque is continuously required in the low-speed range, use a special motor for use with Inverters.

Allowable Load Characteristics of Standard Motor

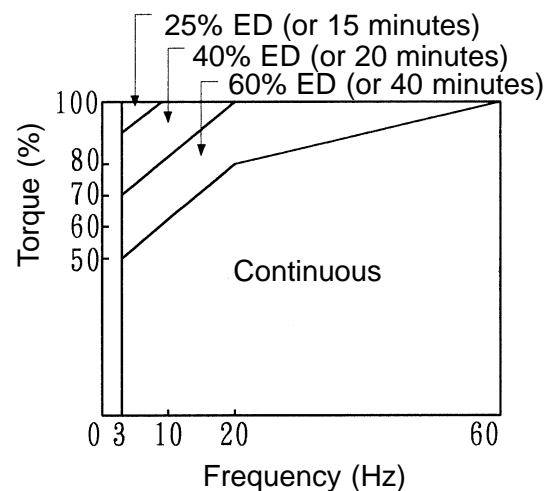

● High-speed Operation

When using the motor at a high speed (60 Hz or more), note that problems may arise in dynamic balance, bearing durability, and so on.

● Torque Characteristics

When the motor is operated with the Inverter, torque characteristics differ from when operated with a commercial power supply. Check the load torque characteristics of the machine to be used with the motor.

● **Vibration**

The 3G3EV series employs high carrier PWM control to reduce motor vibration. When the motor is operated with this Inverter, motor vibration is almost the same as when operated with a commercial power supply.

However, motor vibration may become greater in the following cases:

- **Resonance with the natural frequency of mechanical system**

Take special care when a machine that has been operated at a constant speed is to be operated in variable speed mode. If resonance occurs, install vibration-proof rubber on the motor base.

- **Imbalanced rotor**

Take special care when the motor is operated at a high speed (60 Hz or more).

● **Noise**

Noise is almost the same as when the motor is operated with a commercial power supply. However, motor noise becomes louder when the motor is operated at a speed higher than the rated speed (60 Hz).

■ **Using Inverter for Special Motors**

● **Pole-changing Motor**

The rated amperage of pole-changing motors differs from that of standard motors. Select, therefore, an appropriate Inverter according to the maximum amperage of the motor to be used. Before changing the number of poles, always make sure that the motor has stopped. Otherwise, the overvoltage protection or overcurrent protection mechanism will be actuated, resulting in an error.

● **Submersible Motor**

The rated amperage of submersible motors is higher than that of standard motors. Therefore, always select an Inverter by checking its rated amperage. When the distance between the motor and the Inverter is long, use a cable thick enough to prevent motor torque reduction.

● **Explosion-proof Motor**

When an explosion-proof motor or increased safety type motor is to be used, it must be subject to an explosion-proof test in conjunction with the Inverter. This is also applicable when an existing explosion-proof motor is to be operated with the Inverter. However, since the Inverter itself is not explosion-proof, always install it in a safe place.

● Gearmotor

The speed range for continuous operation differs according to the lubrication method and motor manufacturer. In particular, continuous operation of an oil-lubricated motor in the low speed range may result in burning. If the motor is to be operated at a speed higher than 60 Hz, consult with the manufacturer.

● Synchronous Motor

This motor is not suitable for Inverter control. If a group of synchronous motors is individually turned on and off, synchronism may be lost.

● Single-phase Motor

This motor is not suitable for Inverter control. It should be replaced with a three-phase motor.

■ Power Transmission Mechanism (Speed Reducers, Belts, Chains, and so on)

If an oil-lubricated gearbox or speed reducer is used in the power transmission mechanism, note that oil lubrication will be affected when the motor operates only in the low speed range. Note also that the power transmission mechanism will make noise and experience problems with service life and durability if the motor is operated at a speed higher than 60 Hz.

7-2 Frequency Reference by Amperage Input

Frequency references can be input in terms of amperage (4 to 20 mA) by changing the setting of the DIP switch inside the Inverter.

■ Using the DIP Switch**1. Changing constant settings**

Before using the DIP switch, always set “4” or “5” in constant no. 02 (operation mode selection).

Note n02 = 4: Run commands are input through the Digital Operator, and frequency references are input through control terminals.

n02 = 5: Both run commands and frequency references are input through control terminals.

2. Turning power off

Turn the power off, wait at least one minute after all indicators on the front panel go off, then perform the following tasks.

3. Removing the Digital Operator

- Insert a finger in the recessed section below the Digital Operator, then lift the underneath of the Digital Operator.

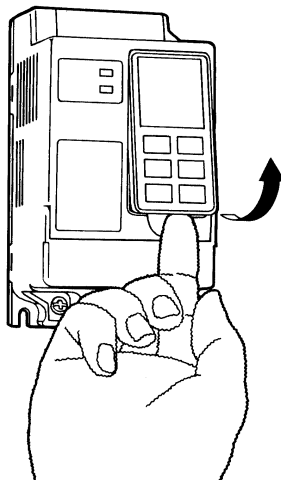

- When the connector comes off, grip the lower edges of the Digital Operator, and slide it down until it comes off.

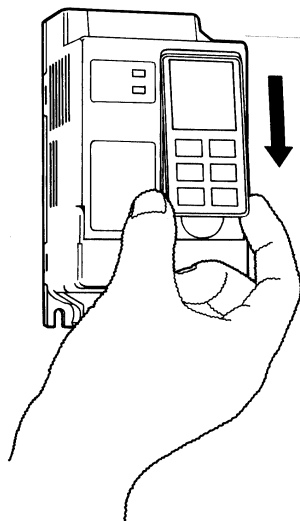

4. Checking the DIP switch setting

The DIP switch is located in the lower part of the recessed section from which the Digital Operator was removed.

“SW1” is marked near the switch.

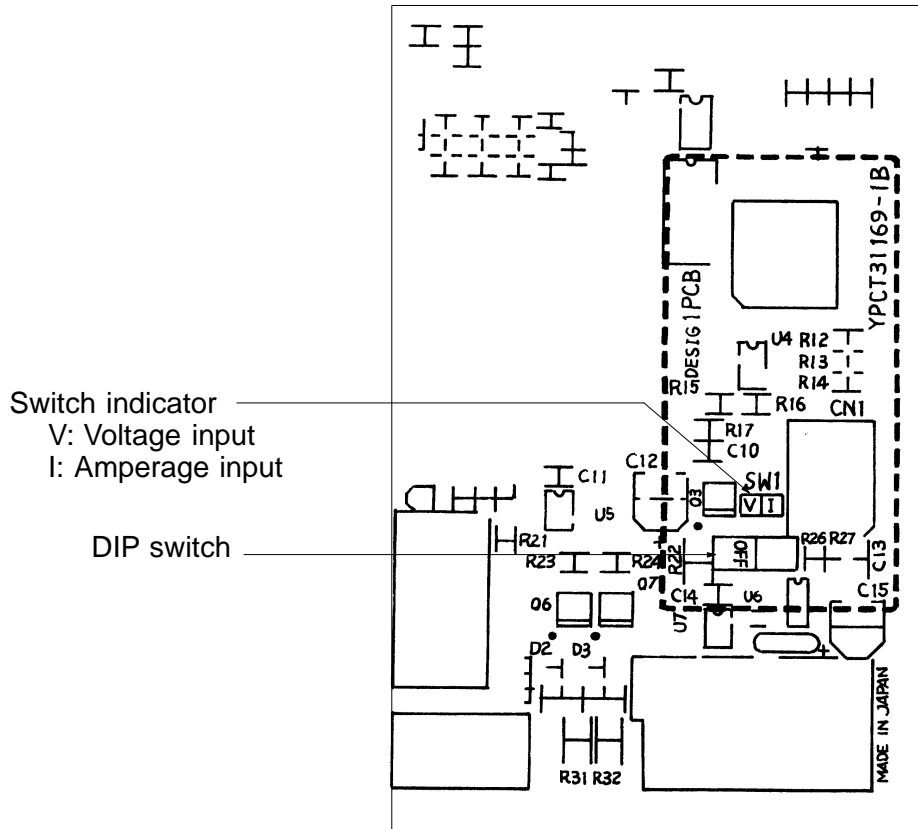

5. Changing the DIP switch setting

To use amperage input mode, set this switch to ON by sliding it to the right.

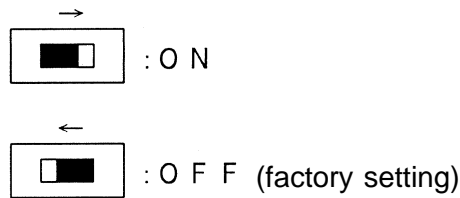

6. Reinstalling the Digital Operator

After changing the switch setting, reinstall the Digital Operator by reversing the removal procedure. Make sure that the Digital Operator snaps in the connector.

Caution If frequency references are input in terms of voltage, never change the DIP switch setting (OFF). If voltage is input when the DIP switch is set to ON, the resistor may burn, resulting in damage to the equipment.

7-3 List of Product Models

■ Inverter

Specifications		Model	
Standard models	Three-phase 200 VAC input	0.1 kW 0.2 kW 0.4 kW 0.75 kW 1.5 kW	3G3EV-A2001(-□) 3G3EV-A2002(-□) 3G3EV-A2004(-□) 3G3EV-A2007(-□) 3G3EV-A2015(-□)
	Single/Three-phase 200 VAC input	0.1 kW 0.2 kW 0.4 kW 0.75 kW 1.5 kW	3G3EV-AB001(-□) 3G3EV-AB002(-□) 3G3EV-AB004(-□) 3G3EV-AB007(-□) 3G3EV-AB015(-□)
	Three-phase 400 VAC input	0.2 kW 0.4 kW 0.75 kW 1.5 kW	3G3EV-A4002(-□) 3G3EV-A4004(-□) 3G3EV-A4007(-□) 3G3EV-A4015(-□)
Multi-function models	Three-phase 200 VAC input	0.1 kW 0.2 kW 0.4 kW 0.75 kW 1.5 kW	3G3EV-A2001M(-□) 3G3EV-A2002M(-□) 3G3EV-A2004M(-□) 3G3EV-A2007M(-□) 3G3EV-A2015M(-□)
	Single/Three-phase 200 VAC input	0.1 kW 0.2 kW 0.4 kW 0.75 kW 1.5 kW	3G3EV-AB001M(-□) 3G3EV-AB002M(-□) 3G3EV-AB004M(-□) 3G3EV-AB007M(-□) 3G3EV-AB015M(-□)
	Three-phase 400 VAC input	0.2 kW 0.4 kW 0.75 kW 1.5 kW	3G3EV-A4002M(-□) 3G3EV-A4004M(-□) 3G3EV-A4007M(-□) 3G3EV-A4015M(-□)
SYSMAC BUS models	Three-phase 200 VAC input	0.1 kW 0.2 kW 0.4 kW 0.75 kW 1.5 kW	3G3EV-A2001R(-□) 3G3EV-A2002R(-□) 3G3EV-A2004R(-□) 3G3EV-A2007R(-□) 3G3EV-A2015R(-□)
	Single/Three-phase 200 VAC input	0.1 kW 0.2 kW 0.4 kW 0.75 kW	3G3EV-AB001R(-□) 3G3EV-AB002R(-□) 3G3EV-AB004R(-□) 3G3EV-AB007R(-□)

■ Braking Resistor (Duty Cycle 3% ED)

Specifications			Model
200-VAC class	0.1 kW/0.2 kW	400 Ω	3G3IV-PERF150WJ401
	0.4 kW/0.75 kW	200 Ω	3G3IV-PERF150WJ201
	1.5 kW	100 Ω	3G3IV-PERF150WJ101
400-VAC class	0.75 kW or less	750 Ω	3G3IV-PERF150WJ751
	1.5 kW	400 Ω	3G3IV-PERF150WJ401

■ Braking Resistor Unit (Duty Cycle 10% ED)

Specifications			Model
200-VAC class	0.4kW/0.75 kW	200 Ω , 70 W	3G3IV-PLKEB20P7
	1.5 kW	100 Ω , 260 W	3G3IV-PLKEB21P5
400-VAC class	0.75 kW or less	750 Ω , 70 W	3G3IV-PLKEB40P7
	1.5 kW	400 Ω , 260 W	3G3IV-PLKEB41P5

■ AC Reactor (for Three-Phase)

Specifications		Model
0.1 to 0.4 kW	2.5 A 4.2 mH	3G3IV-PUZBAB2.5A4.2MH
0.75 kW	5 A 2.1 mH	3G3IV-PUZBAB5A2.1MH
1.5 kW	10 A 1.1 mH	3G3IV-PUZBAB10A1.1MH

■ Input Noise Filter (for Three-Phase)

Specifications		Model
0.1 to 0.4 kW	5 A	3G3IV-PHF3005AZ
0.75 kW	10A	3G3IV-PHF3010AZ
1.5 kW	15 A	3G3IV-PHF3015AZ

■ Output Noise Filter

Specifications		Model
0.1 to 1.5 kW	10 A	3G3IV-PLF310KA

■ Variable Resistor Unit

Specifications		Model
3G3EV	2 k Ω 0.5 W	3G3EV-PETX3200

■ DIN Track

Specifications	Model
3G3EV-A2001(-□) to 3G3EV-A2004(-□) 3G3EV-AB001(-□) and 3G3EV-AB002(-□)	3G3EV-PSPAT3
3G3EV-A2007(-□) to 3G3EV-A2015(-□) 3G3EV-AB004(-□) and 3G3EV-AB007(-□) 3G3EV-A4002(-□) to 3G3EV-A4007(-□)	3G3EV-PSPAT4

List of Constants Used with 3G3EV

Standard Model

Constant no.	Indicators	Description	Setting range		Setting
n01		Constant write-inhibit selection /constant initialization	0: Only n01 can be set. 1: All constants can be set. 8: Constant settings are initialized. 9: Inverter is initialized in 3-wire sequence mode.		
n02	MODE	Mode operation selection		Run command	Frequency reference
			0	Digital Operator	Digital Operator
			1	Control terminal	Digital Operator
			2	Digital Operator	Control terminal (voltage input)
			3	Control terminal	Control terminal (voltage input)
			4	Digital Operator	Control terminal (amperage input)
5	Control terminal	Control terminal (amperage input)			
n03		Stop mode selection	0: Deceleration stop 1: Free running		
n04	F/R	Forward /Reverse rotation selection	<i>For</i> : forward rotation <i>rEv</i> : reverse rotation		
n06		Multi-function input selection	0: Forward/reverse rotation command 1: Fault reset 2: External fault (external fault when ON) 3: External fault (external fault when OFF) 4: Multi-step speed command		
n09		Multi-function output selection	0: Fault occurrence 1: Operation in progress 2: Frequency matching		
n11	FREF	Frequency reference 1	0.0 to 400 (Hz)	[6.0]	
n12	FREF	Frequency reference 2	0.0 to 400 (Hz)	[0.0]	
n20	ACC	Acceleration time	0.0 to 999 (seconds)	[10.0]	

Constant no.	Indicators	Description	Setting range	Setting
n21	DEC	Deceleration time	0.0 to 999 (seconds)	[10.0]
n24	FMAX	Maximum frequency	50.0 to 400 (Hz)	[60.0]
n25	VMAX	Maximum voltage	1 to 255 (V) (see note 1)	[200]
n26	FBAS	Maximum voltage frequency (basic frequency)	1.6 to 400 (Hz)	[60.0]
n31	THR	Electronic thermal reference current	0.0 to 120% of rated Inverter amperage Specify the rated motor amperage.	
n33		Stall prevention during deceleration	0: Stall prevention 1: No stall prevention	
n36		Operation after recovery from power interruption	0: Discontinues operation. 1: Continues operation only if the power interruption is within 0.5 second. 2: Continues operation unconditionally.	
n37		Carrier frequency	1: 2.5 (kHz) (see note 2) 2: 5 (kHz) 3: 7.5 (kHz) 4: 10 (kHz)	
n39		Frequency reference gain	0.10 to 2.00 (times)	[1.00]
n40		Frequency reference bias	-99 to 99 (%)	[0]
n61		Stop Key selection	0, 1	[0]
n64		Operator's frequency setting method	0, 1	[0]

Note 1. The upper limit of setting range and the factory settings for the 400-VAC-class Inverters are double the above values.

Note 2. The setting range of the 400-VAC-class Inverter is “1 to 5.” The factory setting of the 3G3EV-A4015M-CUE is “3.”

Note 3. Values in shaded sections or values in brackets represent factory settings.



Artisan Technology Group is your source for quality new and certified-used/pre-owned equipment

- FAST SHIPPING AND DELIVERY
- TENS OF THOUSANDS OF IN-STOCK ITEMS
- EQUIPMENT DEMOS
- HUNDREDS OF MANUFACTURERS SUPPORTED
- LEASING/MONTHLY RENTALS
- ITAR CERTIFIED SECURE ASSET SOLUTIONS

SERVICE CENTER REPAIRS

Experienced engineers and technicians on staff at our full-service, in-house repair center

*InstraView*SM REMOTE INSPECTION

Remotely inspect equipment before purchasing with our interactive website at www.instraview.com ↗

WE BUY USED EQUIPMENT

Sell your excess, underutilized, and idle used equipment. We also offer credit for buy-backs and trade-ins. www.artisanng.com/WeBuyEquipment ↗

LOOKING FOR MORE INFORMATION?

Visit us on the web at www.artisanng.com ↗ for more information on price quotations, drivers, technical specifications, manuals, and documentation

Contact us: (888) 88-SOURCE | sales@artisanng.com | www.artisanng.com