



## Artisan Technology Group is your source for quality new and certified-used/pre-owned equipment

- FAST SHIPPING AND DELIVERY
- TENS OF THOUSANDS OF IN-STOCK ITEMS
- EQUIPMENT DEMOS
- HUNDREDS OF MANUFACTURERS SUPPORTED
- LEASING/MONTHLY RENTALS
- ITAR CERTIFIED SECURE ASSET SOLUTIONS

### SERVICE CENTER REPAIRS

Experienced engineers and technicians on staff at our full-service, in-house repair center

### *InstraView*<sup>SM</sup> REMOTE INSPECTION

Remotely inspect equipment before purchasing with our interactive website at [www.instraview.com](http://www.instraview.com) ↗

### WE BUY USED EQUIPMENT

Sell your excess, underutilized, and idle used equipment. We also offer credit for buy-backs and trade-ins. [www.artisanng.com/WeBuyEquipment](http://www.artisanng.com/WeBuyEquipment) ↗

### LOOKING FOR MORE INFORMATION?

Visit us on the web at [www.artisanng.com](http://www.artisanng.com) ↗ for more information on price quotations, drivers, technical specifications, manuals, and documentation

**Contact us:** (888) 88-SOURCE | [sales@artisanng.com](mailto:sales@artisanng.com) | [www.artisanng.com](http://www.artisanng.com)

- V/f control
- PID control
- Standard LED, optional LCD operator
- Fieldbus options: DeviceNet
- 7 configurable digital inputs
- 3 configurable digital outputs
- Low audible noise
- Powerful application oriented functionality
- High slip braking
- Easy maintenance
- Energy saving function



### Ordering Information

Product code	Description
3G3PV- □□ □□□ - E A 2 kW B 4	A = IP20, B = IP00, 2 = 200V Type, 4 = 400V Type Example: 3G3PV - A4007-E SYSDrive 3G3PV Inverter
I537-E2-01	3G3PV High-function General-purpose Inverters for Variable Torque Applications User's Manual

### Specifications

#### ■ 200-V Class Inverters

3G3PV-		A												
		2004	2007	2015	2022	2037	2055	2075	2110	2150	2185	2220	2300	2370
<b>Max. applicable motor output (kW) (note 1)</b>		0.4	0.75	1.5	2.2	3.7	5.5	7.5	11	15	18.5	22	30	37
<b>Output ratings</b>	<b>Rated output capacity (kVA)</b>	1.2	1.6	2.7	3.7	5.7	8.8	12	17	22	27	32	44	55
	<b>Rated output current (A)</b>	3.2	4.1	7.0	9.6	15	23	31	45	58	71	85	115	145
	<b>Max. output voltage (V)</b>	3-phase; 200, 208, 220, 230 or 240 VAC (Proportional to input voltage.)												
	<b>Max. output frequency (Hz)</b>	120 Hz max.												
<b>Power supply</b>	<b>Rated voltage (V)</b> <b>Rated frequency (Hz)</b>	3-phase, 200/208/220/230/240 VAC, 50/60 Hz												
	<b>Allowable voltage fluctuation</b>	-15% to +10%												
	<b>Allowable frequency fluctuation</b>	±5%												
<b>Control</b>	<b>Measures for power supply harmonics</b>	<b>DC reactor</b>	Optional										Built in	
		<b>12-phase rectification</b>	Not possible										Possible (note 2)	

- Note**
1. The maximum applicable motor output is given for a standard 4-pole OMRON motor. When selecting the actual motor and Inverter, be sure that the Inverter's rated current is applicable for the motor's rated current.
  2. A 3-wire transformer is required on the power supply for 12-phase rectification.

3G3PV-			A				B							
			2450	2550	2750	2900	2220	2300	2370	2450	2550	2750	2900	211K
Max. applicable motor output (kW) (note 1)			45	55	75	90	22	30	37	45	55	75	90	110
Output ratings	Rated output capacity (kVA)		69	82	110	130	32	44	55	69	82	110	130	160
	Rated output current (A)		180	215	283	346	85	115	145	180	215	283	346	415
	Max. output voltage (V)		3-phase 200, 208, 220, 230 or 240 VAC (Proportional to input voltage)											
	Max. output frequency (Hz)		120 Hz max.											
Power supply	Rated voltage (V) Rated frequency (Hz)		3-phase, 200/208/220/230/240 VAC, 50/60 Hz											
	Allowable voltage fluctuation		+ 10%, - 15%											
	Allowable frequency fluctuation		±5%											
Control	Measures for power supply harmonics	DC reactor	Built in											
		12-phase rectification	Possible (note 2)											

### ■ 400-V Class Inverters

3G3PV-			A											
			4004	4007	4015	4022	4037	4040	4055	4075	4110	4150	4185	
Max. applicable motor output (kW) (note 1)			0.4	0.75	1.5	2.2	3.7	4.0	5.5	7.5	11	15	18.5	
Output ratings	Rated output capacity (kVA)		1.4	1.6	2.8	4.0	5.8	6.6	9.5	13	18	24	30	
	Rated output current (A)		1.8	2.1	3.7	5.3	7.6	8.7	12.5	17	24	31	39	
	Max. output voltage (V)		3-phase; 380, 400, 415, 440, 460 or 480 VAC (Proportional to input voltage.)											
	Max. output frequency (Hz)		120 Hz max.											
Power supply	Rated voltage (V) Rated frequency (Hz)		3-phase, 380, 400, 415, 440, 460 or 480 VAC, 50/60 Hz											
	Allowable voltage fluctuation		+ 10%, - 15%											
	Allowable frequency fluctuation		±5%											
Control	Measures for power supply harmonics	DC reactor	Optional											
		12-phase rectification	Not possible											

3G3PV-			A / B											
			4220	4300	4370	4450	4550	4750	4900	411K	413K	416K		
Max. applicable motor output (kW) (note 1)			22	30	37	45	55	75	90	110	132	160		
Output ratings	Rated output capacity (kVA)		34	46	57	69	85	110	140	160	200	230		
	Rated output current (A)		45	60	75	91	112	150	180	216	260	304		
	Max. output voltage (V)		3-phase, 380, 400, 415, 440, 460 or 480 VAC (Proportional to input voltage.)											
	Max. output frequency (Hz)		120 Hz max.											
Power supply	Max. voltage (V) Rated frequency (Hz)		3-phase, 380, 400, 415, 440, 460 or 480 VAC, 50/60 Hz											
	Allowable voltage fluctuation		+ 10%, - 15%											
	Allowable frequency fluctuation		±5%											
Control	Measures for power supply harmonics	DC reactor	Built in											
		12-phase rectification	Possible (note 2)											

- Note**
1. The maximum applicable motor output is given for a standard 4-pole OMRON motor. When selecting the actual motor and Inverter, be sure that the Inverter's rated current is applicable for the motor's rated current.
  2. A 3-wire transformer is required on the power supply for 12-phase rectification.

## ■ Common Specifications

3G3PV-		Specification
Control characteristics	Control method	Sine wave PWM V/f control
	Speed control range	1:40
	Speed control accuracy	±2 to 3% (25°C ± 10°C)
	Frequency accuracy (temperature characteristics)	Digital references: ± 0.01% (-10°C to +40°C)
		Analog references: ±0.1% (25°C ±10°C)
	Frequency setting resolution	Digital references: 0.01 Hz
		Analog references: 0.05/50 Hz (10 bit no sign)
	Overload capacity and maximum current (note 1)	120% of rated output current per minute
	Frequency setting signal	0 to 10 V, 4 to 20 mA
Acceleration/Deceleration time	0.0 to 6000.0 s (4 selectable combinations of independent acceleration and deceleration settings)	
Main control functions	Restarting for momentary power loss, speed searches, overtorque detection, 4-speed control (maximum), acceleration/deceleration time changes, S-curve acceleration, 3-wire sequence, autotuning, cooling fan ON/OFF control, torque compensation, jump frequencies, upper and lower limits for frequency references, DC braking for starting and stopping, high-slip braking, PI control (with sleep function), energy-saving control, RS-422A/485 communications (19.2 kbps maximum), fault reset and function copying.	
Protective function	Motor protection	Protection by electronic thermal overload relay.
	Fuse blown protection	Stops for fuse blown.
	Overload protection	120% of rated output current for 1 minute
	Overvoltage protection	200 Class Inverter: Stops when main-circuit DC voltage is above 410 V. 400 Class Inverter: Stops when main-circuit DC voltage is above 820 V.
	Undervoltage protection	200 Class Inverter: Stops when main-circuit DC voltage is below 190 V. 400 Class Inverter: Stops when main-circuit DC voltage is below 380 V.
	Momentary power loss ride-thru	Stops for 15 ms or more.
		By selecting the momentary power loss method, operation can be continued if power is restored within 2 s.
	Cooling fin overheating	Protection by thermistor.
	Stall prevention	Stall prevention during acceleration, deceleration or running.
	Grounding protection	Protection by electronic circuits. (50% of inverter rated current)
Charge indicator	Lit when the main circuit DC voltage is approx. 50 V or more.	
Environment	Application site	Indoor (no corrosive gas, dust, etc.)
	Ambient operating temperature	-10°C to 40°C (Enclosed wall-mounted type)
		-10°C to 45°C (Open chassis type)
	Ambient operating humidity	95% max. (with no condensation)
	Storage temperature	- 20°C to + 60°C (short-term temperature during transportation)
	Altitude	1000 m max. (note 2)
	Vibration	10 to 20 Hz, 9.8 m/s <sup>2</sup> max.; 20 to 50 Hz, 2 m/s <sup>2</sup> max
Protective structure	Enclosed wall-mounted type (NEMA 1): 18.5 kW or less (same for 200 V and 400 V class) Open chassis type (IP00): 22 kW or more (same for 200 V and 400 V class Inverters)	

- Note**
1. Increase the Inverter capacity if loads exceeding these current values are expected.
  2. If applied in higher altitudes contact your OMRON representative.

## ■ Digital Operators

### Digital Operator with LED Display (3G3IV-PJVOP161)

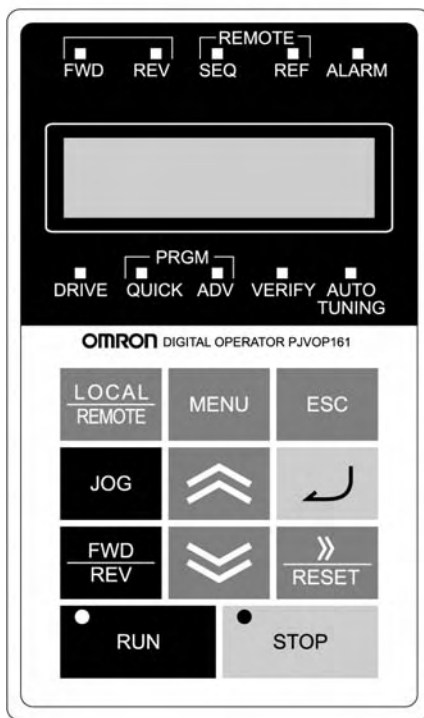

#### Drive Mode Indicators

- FWD: Lit when there is a forward run command input.
- REV: Lit when there is a reverse run command input.
- SEQ: Lit when the run command from the control circuit terminal is enabled.
- REF: Lit when the frequency reference from control circuit terminals A1 and A2 is enabled.
- ALARM: Lit when an error or alarm has occurred.

#### Data Display

Displays monitor data, parameter numbers, and settings (in five digits).

#### Mode Display

- DRIVE: Lit in Drive Mode.
- QUICK: Lit in Quick Programming Mode.
- ADV: Lit in Advanced Programming Mode.
- VERIFY: Lit in Verify Mode.
- A. TUNE: Lit in Autotuning Mode.

#### Keys

Execute operations such as setting parameters, monitoring, jogging, and autotuning.

### Digital Operator with LCD Display (3G3IV-PJVOP160)

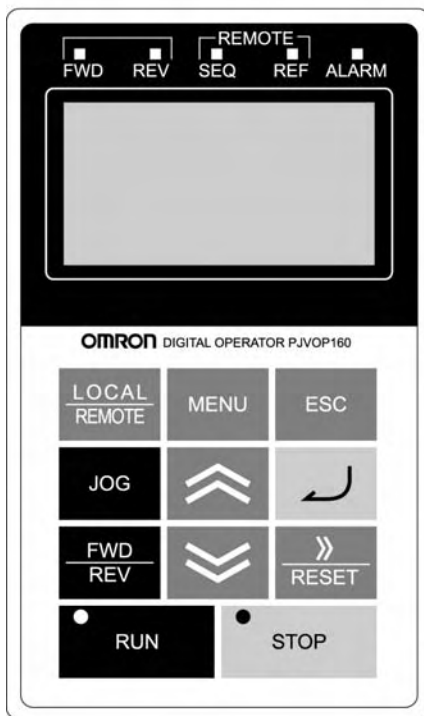

#### Drive Mode Indicators

- FWD: Lit when there is a forward run command input.
- REV: Lit when there is a reverse run command input.
- SEQ: Lit when the run command from the control circuit terminal is enabled.
- REF: Lit when the frequency reference from control circuit terminals A1 and A2 is enabled.
- ALARM: Lit when an error or alarm has occurred.

#### Data Display

Displays monitor data, parameter numbers, and settings.

#### Keys

Execute operations such as setting parameters, monitoring, jogging, and autotuning.

# Dimensions

## ■ Open Chassis Inverters (IP00)

Exterior diagrams of the Open Chassis Inverters are shown below.

A. 200-V class Inverters of 22 to 30 kW  
400-V class Inverters of 22 to 55 kW

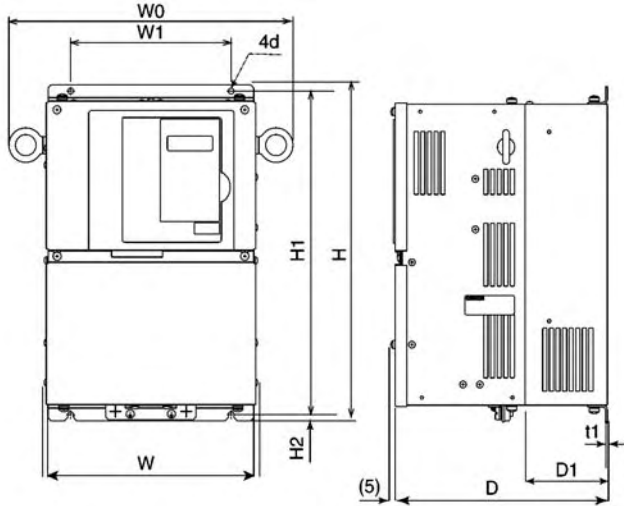

B. 200-V class Inverters of 37 to 110 kW  
400-V class Inverters of 75 to 160 kW

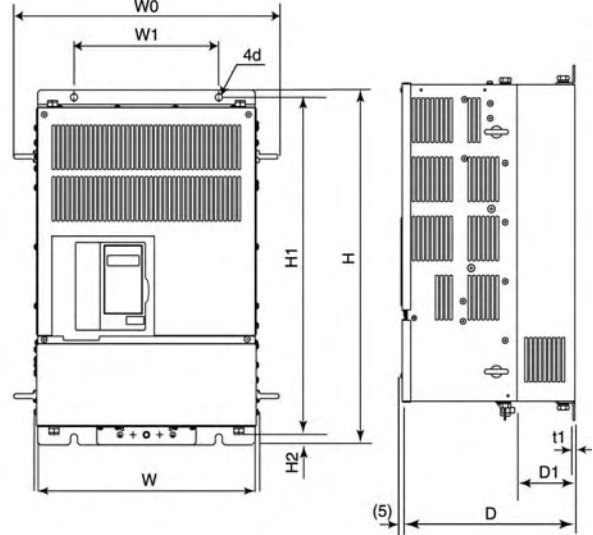

## ■ Enclosed Wall-mounted Inverters (NEMA 1)

Exterior diagrams of the Enclosed Wall-mounted Inverters (NEMA 1) are shown below.

C. 200-V/400-V class Inverters of 0.4 to 18.5 kW

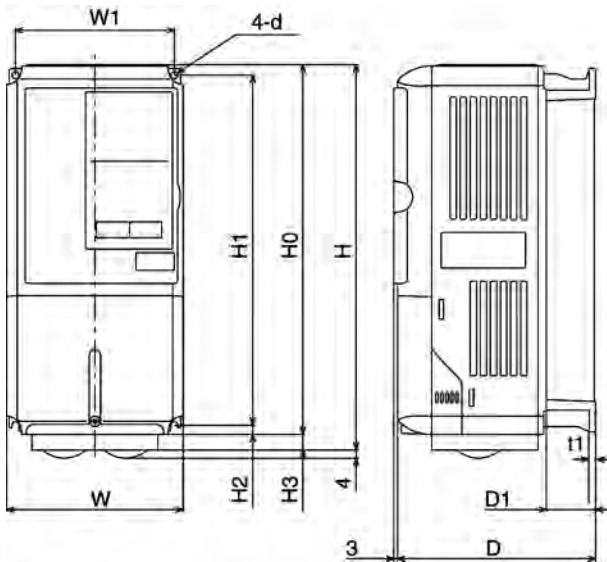

D. 200-V class Inverters of 22 to 75 kW  
400-V class Inverters of 22 to 160 kW

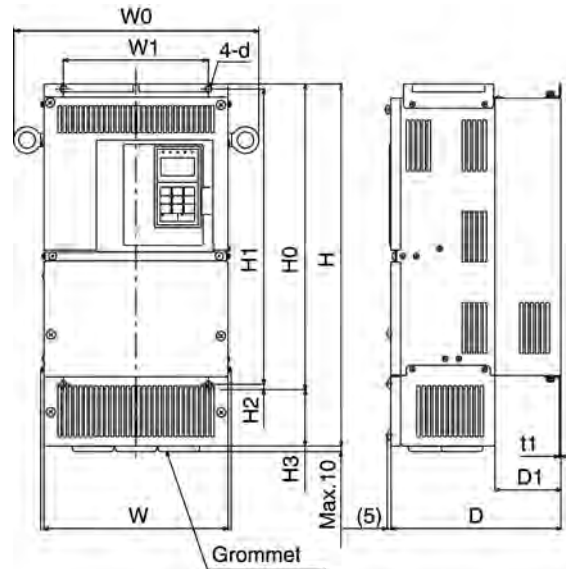

(A 200-V class, 22-kW Inverter is shown as an example sold only in Europe.)

Voltage Class	Max. Applicable Motor Output [kW]	Dimensions (mm)																			Caloric Value(W)			Cooling Method		
		Open Chassis (IP00)									Enclosed Wall-mounted (NEMA1, IP20)										External	Internal	Total Heat Generation			
		W	H	D	W1	H1	H2	D1	t1	Ap-prox. Mass	W	H	D	W1	H0	H1	H2	H3	D1	t1					Ap-prox. Mass	Mounting Holes d(note1)
200 V (3-phase)	0.4	140	280	157	126	266	7	39	5	3	140	280	157	126	280	266	7	0	39	5	3	M5	20	39	59	Natural
	0.75																						27	42	69	
	1.5																						50	50	100	
	2.2			70				59					129													
	3.7			112				74					186													
	5.5			164				84					248													
	7.5	200	300	197	186	285	7.5	78	2.3	65.5	6	200	300	197	186	300	285	7.5	10	65.5	6	M6	219	113	332	Fan
	11																						374	170	544	
	15	240	350	207	216	335	7.5	100	2.3	11	240	350	207	216	350	335	7.5	0	78	2.3	11	M6	429	183	612	
	18.5																						501	211	712	
	22	254	400	258	195	385	7.5	100	2.3	21	255	535	258	195	400	385	7.5	135	100	24	M6	586	274	860		
	30	279	450	220	435	24																280	615	220	450	
	37	379	600	298	250	575	13	100	3.2	57	380	809	300	250	600	575	13	210	100	3.2	62	M10	1015	411	1426	
	45																						63	330	330	
	55	454	725	348	325	700	13	130	3.2	86	455	102	350	325	725	700	13	305	130	3.2	94	M10	1588	619	2207	
	75																						87	350	325	
90	505	850	358	370	820	15	140	4.5	108	504	124	360	370	828	820	7.8	408	130	4.5	114	M12	2437	997	3434		
110	579	885	378	445	855																	150	2733	1242	3975	

Note 1. Same for Open Chassis and Enclosed Wall-mounted Inverters.



# Installation

## ■ Wiring

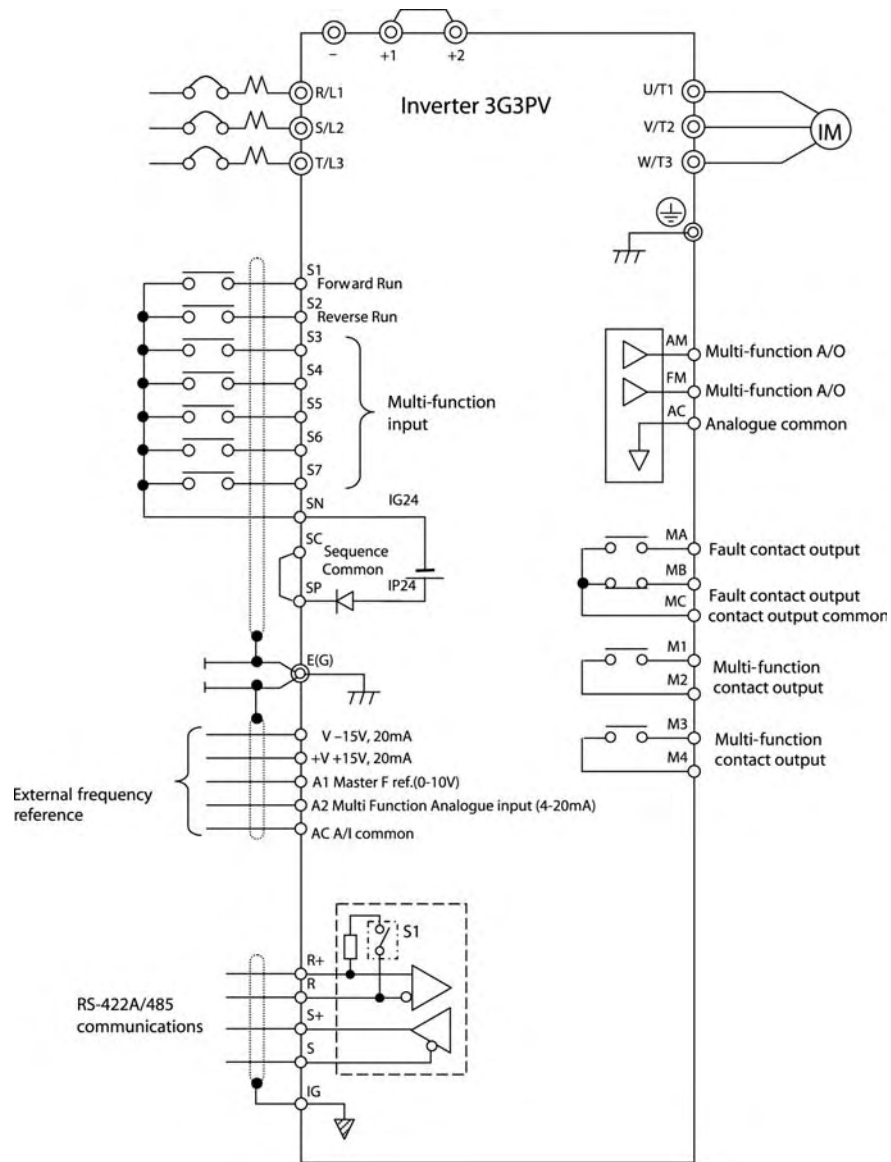



# Accessories

## ■ Option cards

Purpose	Name	Model (Code)	Descriptions
Protect Inverter wiring	MCCB or Ground Fault Interrupter (note 1)	Example: Mitsubishi Electric - NV Series, Fuji Electric - EG, SG series	Always connect a breaker to the power supply line to protect Inverter wiring. Use a ground fault interrupter suitable for high frequencies.
Prevents burning when a Braking Resistor is used	Magnetic Contactor	Example: Fuji Electric SC Series	Install to prevent the braking resistor from burning out when one is used. Always attach a surge absorber to the coil.
Contains switching surge	Surge Absorber	DCR2-□	Absorbs surge from the magnetic contactor and control relays. Connect surge absorbers to all magnetic contactors and relays near the Inverter.
Isolates I/O signals	Isolator	DGP□	Isolates the I/O signals of the Inverter and is effective against inductive noise.
Improves the input power factor of the Inverter	DC Reactor	3G3HV-PUZDAB□	Used to improve the input power factor of the Inverter. All Inverters of 22 kW or higher contain built-in DC reactors. These are optional for Inverters of 18.5 kW or less. Install DC and AC reactors for applications with a large power supply capacity (600 kVA or higher).
	AC Reactor	3G3IV-PUZBAB□	
Reduces the affects of radio and control device noise	Input Noise Filter	3G3IV-PFN□ 3G3EV-PLNF□	Reduces noise coming into the inverter from the power supply line and to reduce noise flowing from the inverter into the power supply line. Connect as close to the Inverter as possible.
	Output Noise Filter	3G3IV-PLF□	Reduces noise generated by the inverter. Connect as close to the inverter as possible.
Enables stopping the machine in a set time	Braking Resistor Unit	3G3IV-PLKEB□	Consumes the regenerative motor energy with a resistor to reduce deceleration time (use rate: 10% ED). (Braking Unit is needed.)
	Braking Unit	3G3IV-PCDBR□B	Used with a Braking Resistor Unit to reduce the deceleration time of the motor.
Operates the Inverter externally	Analog Operator (small plastic Operator)	3G3IV-PJVOP95□	Allows frequency reference settings and ON/OFF operation control to be performed by analog references from a remote location (50 m max.). Frequency counter specifications: 60/120 Hz, 90/180Hz
	Analog Operator (Standard steel-plate Operator)	3G3IV-PJVOP96□ (73041-0906X-□)	Allows frequency reference settings and ON/OFF operation control to be performed by analog references from a remote location (50 m max.). Frequency counter specifications: 75 Hz, 150 Hz, 220 Hz
	Digital Operator Connection Cable	1 m cable: (3G3IV-PCN126) 3 m cable: (3G3IV-PCN326-E)	Extension cable to use a Digital Operator remotely. Cable length: 1 m or 3 m
Controls an Inverter system	VS System Module	JGSM-□	A system controller that can be match to the automatic control system to produce an optimum system configuration.
Provides Inverter momentary power loss recovery time	Momentary Power Loss Recovery Unit	3G3IV-PCN□26	Handles momentary power losses for the control power supply for models 2.2 kW or less (maintains power for 2 s).
Sets/monitors frequencies and voltages externally	Scaling Meter	K3TJ-V11□	Measurs the output voltage externally and designed for use with a PWM meter.

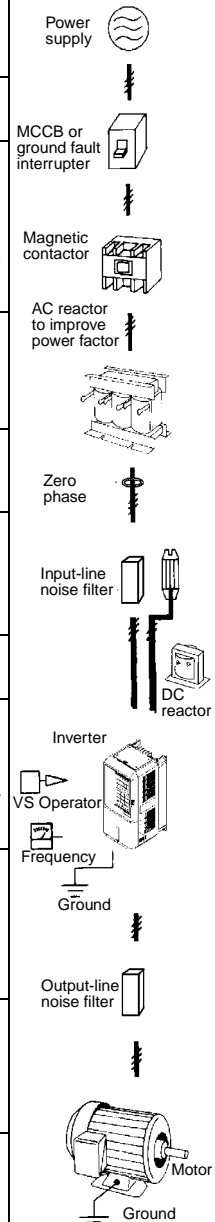

**Note** 1. Use a ground fault interrupter with a current sensitivity of 200 mA minimum and an operating time of 0.1 s minimum to prevent operating errors. The interrupter must be suitable for high-frequency operation.

**Separately Installed Options**



K3TJ-V11□  
Scaling Meter



3G3IV-PJVOP96□  
Analog Operator  
(standard, steel panels)



3G3IV-PJVOP95□  
Analog Operator  
(small, plastic)

**Special Options**



3G3IV-PCDBR□B  
Braking Unit



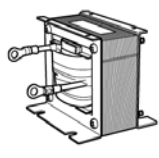

3G3IV-PLKEB□  
Braking Resistor Unit



3G3HV-PUZDAB□  
DC Reactor



3G3FV-PCN□25  
Digital Operator  
Connection Cable



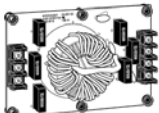

Digital Operator  
3G3IV-PJVOP161 (LED)  
3G3IV-PJVOP160 (LCD)

**Recommended Separately Installed Options**

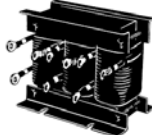

3G3EV-PLNFD□  
Simple Input Noise Filter



3G3IV-PUZBAB□  
AC Reactor



3G3IV-PFN□  
Input Noise Filter

**Recommended Separately Installed Options**

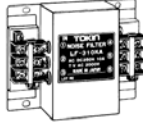

3G3IV-PLF□  
Output Noise Filter



Power supply  
3-phase, 200 VAC (200-V Class)  
3-phase, 400 VAC (400-V Class)

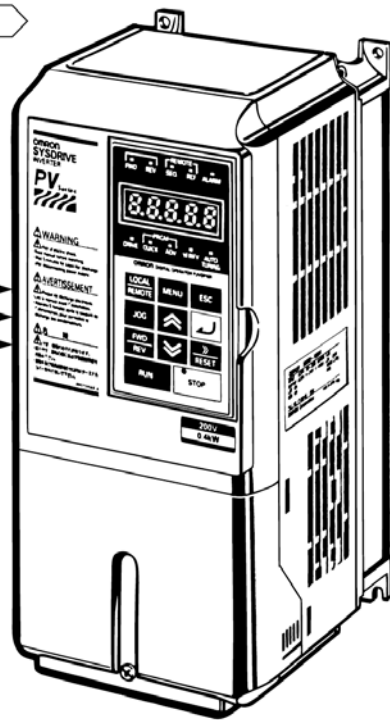

**Option Cards**

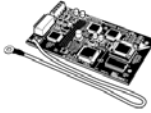

3G3FV-PDRT1-SIN  
DeviceNet Communications Card

Type	Name	Model number	Application
Special Mounted Options	Fan Unit	3G3IV-PFAN□	Replacement fan for Inverters equipped with a cooling fan. Replace the Cooling Fan when the fan replacement time has come or a cooling fan fault (FAN) alarm has been displayed.
Separately Installed Options	Scaling Meter	K3TJ-V11□	Connects to a multi-function analog output from the Inverter. Used to display rotational speeds of motors, line speeds, etc., in physical units.
	Analog Operator (standard with steel panels)	3G3IV-PJVOP96□	Allows frequency reference settings and ON/OFF operation control to be performed by analog references from a remote location (50 m max.). Frequency counter specifications: 75 Hz, 150 Hz, 220 Hz
	Analog Operator (small, plastic)	3G3IV-PJVOP95□	Allows frequency reference settings and ON/OFF operation control to be performed by analog references from a remote location (50 m max.). Frequency counter specifications: 60/120 Hz, 90/180Hz
Special Options	Braking Unit	3G3IV-PCDBR□B	Used with a Braking Resistor Unit to reduce the deceleration time of the motor. Not required with Inverters of 7.5 kW or less for 200-V class Inverters or for Inverters of 15 kW or less for 400-V class Inverters.
	Braking Resistor Unit	3G3IV-PLKEB□	Consumes the regenerative motor energy with a resistor to reduce deceleration time (use rate: 10% ED).
	DC Reactor	3G3HV-PUZDAB□	Used to control harmonics generated by the Inverter and to improve the input power factor of the Inverter. All Inverters of 18.5 kW or higher contain built-in DC reactors.
	Digital Operator with LCD Display	3G3IV-PJVOP160	Displays messages on a LCD.
	Digital Operator with LED Display	3G3IV-PJVOP161	Display messages on a LED display. Standard in Asia and Europe.
	Digital Operator Connection Cable	3G3IV-PCN126 (1 m)	Extension cable to use a 3G3PV-series Digital Operator remotely. Cable length: 1 m or 3 m
		3G3IV-PCN326-E (3 m)	
Personal Computer cable	3G3IV-PCN329-E	Connection cable for connecting the 3G3PV series Inverter to the SYS-Drive configurator (software tool) on Personal Computer.	
Option cards	DeviceNet Communications Card	3G3FV-PDRT1-SIN	Used for DeviceNet communications with a Programmable Controller or other DeviceNet master device.
Terminal cards	Standard terminal card	3G3PV-PETC618140	Standard terminal card for standard operation
	Optional terminal card	3G3PV-PETC618120	Optional terminal card (with shunt connector CN15) for switching the analog output levels between (0-10V) or (4 to 20 mA).
Recommended Separately Installed Options (note 1)	AC Reactor	3G3IV-PUZBAB□	Used to control harmonics generated by the Inverter or when the power supply capacity is greatly larger than the Inverter's capacity. Also used to increase the power factor.
	Simple Input Noise Filter	3G3EV-PLNFD□	Reduces noise coming into the inverter from the power supply line and to reduce noise flowing from the inverter into the power supply line. Connected to the power supply input side.
	Input Noise Filter (Schaffner)	3G3IV-PFN□	Reduces noise coming into the inverter from the power supply line and to reduce noise flowing from the inverter into the power supply line. Connected to the power supply input side.
	Input Noise Filter (Schaffner) for EMC Directive	3G3RV-PFI□-SE	Required for the 3G3PV Inverter to meet the EMC Directive.
	Input Noise Filter (Rasmi) for EMC Directive	3G3RV-PFI□-E	Required for the 3G3PV Inverter to meet the EMC Directive.
	Output Noise Filter (Tokin)	3G3IV-PLF□	Controls noise generated by the Inverter so it does not enter the power supply. Connected to the motor output side.

**Note** 1. Recommended Options can be ordered from OMRON using the above model numbers.

## ■ Filters

### Filter Specifications by Schaffner

Mounting	3G3PV-	OMRON product code	Current (A)	Footprint & mounting dimensions (mm)					
				W	H	D	W1	H1	d
foot / book	A2004 / A2007 / A2015	3G3RV-PFI3010-SE	6-5-10	141	330	46	115	313	M4
	A2022	3G3RV-PFI3018-SE	15	141	330	46	115	313	M4
	A2037 / A2055	3G3RV-PFI2035-SE	25 / 35	141	330	46	115	313	M5
	A2075 / A2110	3G3RV-PFI2060-SE	45 / 60	206	355	60	175	336	M6
	A2150 / A2185	3G3RV-PFI2100-SE	85 / 100	236	408	80	205	390	M6
	A4004 / A4007 / A4015 / A4022	3G3RV-PFI3010-SE	3 / 4 / 5 / 8	141	330	46	115	313	M4
	A4037 / A4040 / A4055	3G3RV-PFI3018-SE	15-12-18	141	330	46	115	313	M4
	A4075 / A4110	3G3RV-PFI3035-SE	25 / 35	206	355	50	175	336	M5
	A4150 / A4185	3G3RV-PFI3060-SE	45 / 60	236	408	65	205	390	M6
book	B2200 / B2300	3G3RV-PFI2130-SE	100 / 130	90	366	180	65	295	M10
	B2370	3G3RV-PFI2160-SE	160	120	451	170	102	365	M10
	B2450 / B2550	3G3RV-PFI2200-SE	200 / 240	130	610	240	90	498	M10
	B2750 / B2900	3G3RV-PFI3400-SE	320 / 390	300	564	160	275	420	M8
	B4220 / B4300	3G3RV-PFI3070-SE	60 / 70	80	329	185	55	314	M6
	B4370 / B4450 / B4550	3G3RV-PFI3130-SE	90 / 110 / 130	90	366	180	65	295	M10
	B4750	3G3RV-PFI3170-SE	170	120	451	170	102	365	M10
	B4900 / B411K	3G3RV-PFI3200-SE	200 / 250	130	610	240	90	498	M10
	B413K / B416K	3G3RV-PFI3400-SE	300 / 350	300	564	160	275	420	M8

### Filter Specifications by Rasmi

Mounting	3G3PV-	OMRON product code	Current (A)	Footprint & mounting dimensions (mm)					
				W	H	D	W1	H1	d
foot	A2004-E / A2007-E / A2015-E	3G3RV-PFI3010-E	10	143	330	46	115	313	M5
	A2022-E	3G3RV-PFI3018-E	18	143	330	46	115	313	M5
	A2037-E / A2055-E	3G3RV-PFI2035-E	35	143	330	46	115	313	M5
	A2075-E / A2110-E	3G3RV-PFI2060-E	60	213	355	60	175	336	M6
	A2150-E / A2185-E	3G3RV-PFI2100-E	100	238	408	80	205	390	M6
	A4004-E / A4007-E / A4015-E / A4022-E	3G3RV-PFI3010-E	10	143	330	46	115	313	M5
	A4037-E / A4055-E	3G3RV-PFI3018-E	18	143	330	46	115	313	M5
	A4075-E / A4110-E	3G3RV-PFI3035-E	35	213	355	51	175	336	M6
	A4150-E / A4185-E	3G3RV-PFI3060-E	60	238	408	60	205	390	M6
book	B2220-E / B2300-E	3G3RV-PFI2130-E	130	90	310	180	65	295	M6
	B2370-E	3G3RV-PFI2160-E	160	120	380	170	102	365	M6
	B2450-E	3G3RV-PFI2200-E	200	130	518	240	90	498	M8
	B4220-E / B4300-E	3G3RV-PFI3070-E	70	80	329	220	55	314	M6
	B4370-E / B4450-E	3G3RV-PFI3100-E	100	90	310	180	65	295	M6
	B4550-E	3G3RV-PFI3130-E	130	90	310	180	65	295	M6
	B4750-E	3G3RV-PFI3170-E	170	120	380	170	102	365	M6
	B4900-E	3G3RV-PFI3200-E	200	130	518	240	90	498	M8

## ■ Filter Dimensions

### Book/foot style mounting

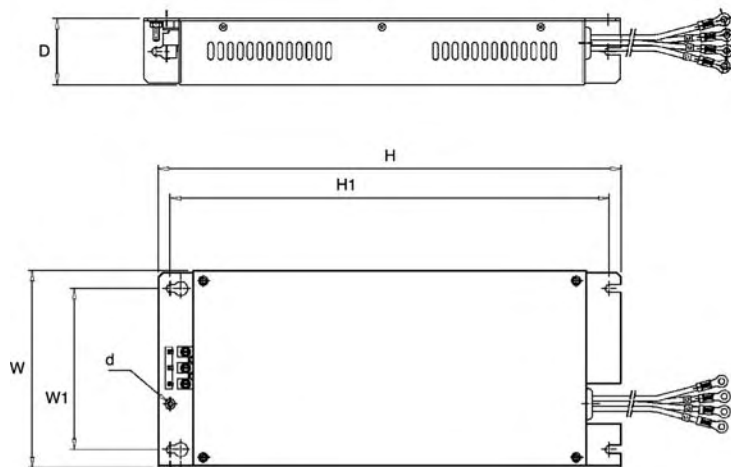

### Book style mounting

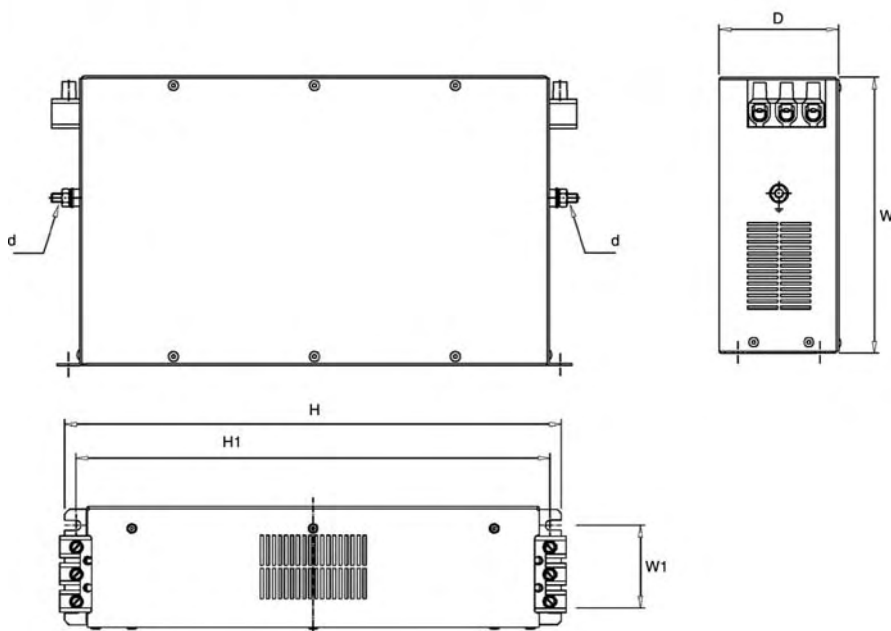

**ALL DIMENSIONS SHOWN ARE IN MILLIMETERS.**

To convert millimeters into inches, multiply by 0.03937. To convert grams into ounces, multiply by 0.03527.

Cat. No. I209-E2-01

**In the interest of product improvement, specifications are subject to change without notice.**

## OMRON EUROPE B.V.

Wegalaan 67-69  
2132 JD Hoofddorp  
The Netherlands  
Phone: +31 23 568 13 00  
Fax: +31 23 568 13 88

Printed in the Netherlands



## Artisan Technology Group is your source for quality new and certified-used/pre-owned equipment

- FAST SHIPPING AND DELIVERY
- TENS OF THOUSANDS OF IN-STOCK ITEMS
- EQUIPMENT DEMOS
- HUNDREDS OF MANUFACTURERS SUPPORTED
- LEASING/MONTHLY RENTALS
- ITAR CERTIFIED SECURE ASSET SOLUTIONS

### SERVICE CENTER REPAIRS

Experienced engineers and technicians on staff at our full-service, in-house repair center

### *InstraView*<sup>SM</sup> REMOTE INSPECTION

Remotely inspect equipment before purchasing with our interactive website at [www.instraview.com](http://www.instraview.com) ↗

### WE BUY USED EQUIPMENT

Sell your excess, underutilized, and idle used equipment. We also offer credit for buy-backs and trade-ins. [www.artisanng.com/WeBuyEquipment](http://www.artisanng.com/WeBuyEquipment) ↗

### LOOKING FOR MORE INFORMATION?

Visit us on the web at [www.artisanng.com](http://www.artisanng.com) ↗ for more information on price quotations, drivers, technical specifications, manuals, and documentation

**Contact us:** (888) 88-SOURCE | [sales@artisanng.com](mailto:sales@artisanng.com) | [www.artisanng.com](http://www.artisanng.com)