



Artisan Technology Group is your source for quality new and certified-used/pre-owned equipment

- FAST SHIPPING AND DELIVERY
- TENS OF THOUSANDS OF IN-STOCK ITEMS
- EQUIPMENT DEMOS
- HUNDREDS OF MANUFACTURERS SUPPORTED
- LEASING/MONTHLY RENTALS
- ITAR CERTIFIED SECURE ASSET SOLUTIONS

SERVICE CENTER REPAIRS

Experienced engineers and technicians on staff at our full-service, in-house repair center

*InstraView*SM REMOTE INSPECTION

Remotely inspect equipment before purchasing with our interactive website at www.instraview.com ↗

WE BUY USED EQUIPMENT

Sell your excess, underutilized, and idle used equipment. We also offer credit for buy-backs and trade-ins. www.artisanng.com/WeBuyEquipment ↗

LOOKING FOR MORE INFORMATION?

Visit us on the web at www.artisanng.com ↗ for more information on price quotations, drivers, technical specifications, manuals, and documentation

Contact us: (888) 88-SOURCE | sales@artisanng.com | www.artisanng.com

Lighted Pushbutton Switch

A3C

Cylindrical 12-dia. Series with Superb Operability, High Visibility, and Compact Housing

- Three models of Pushbuttons (round, square, and rectangular), two types of light-emitting elements (LED lamp and incandescent lamp), and two types of Switches (switching standard loads and microloads) available.
- Models that can be used as an indicator also available.
- Requires only 20 mm mounting depth
- Efficiency in wiring improved by terminals arranged on the same surface.
- All LED lamps, incandescent lamps, caps, and legends replaceable without tools.
- UL (E41515) and CSA (LR45258) approved.



Ordering Information

Model Number Legend

When placing your order, specify the individual component part model numbers of the Pushbutton, Lamp (lighted models only), and Switch, as listed in the ordering tables below.

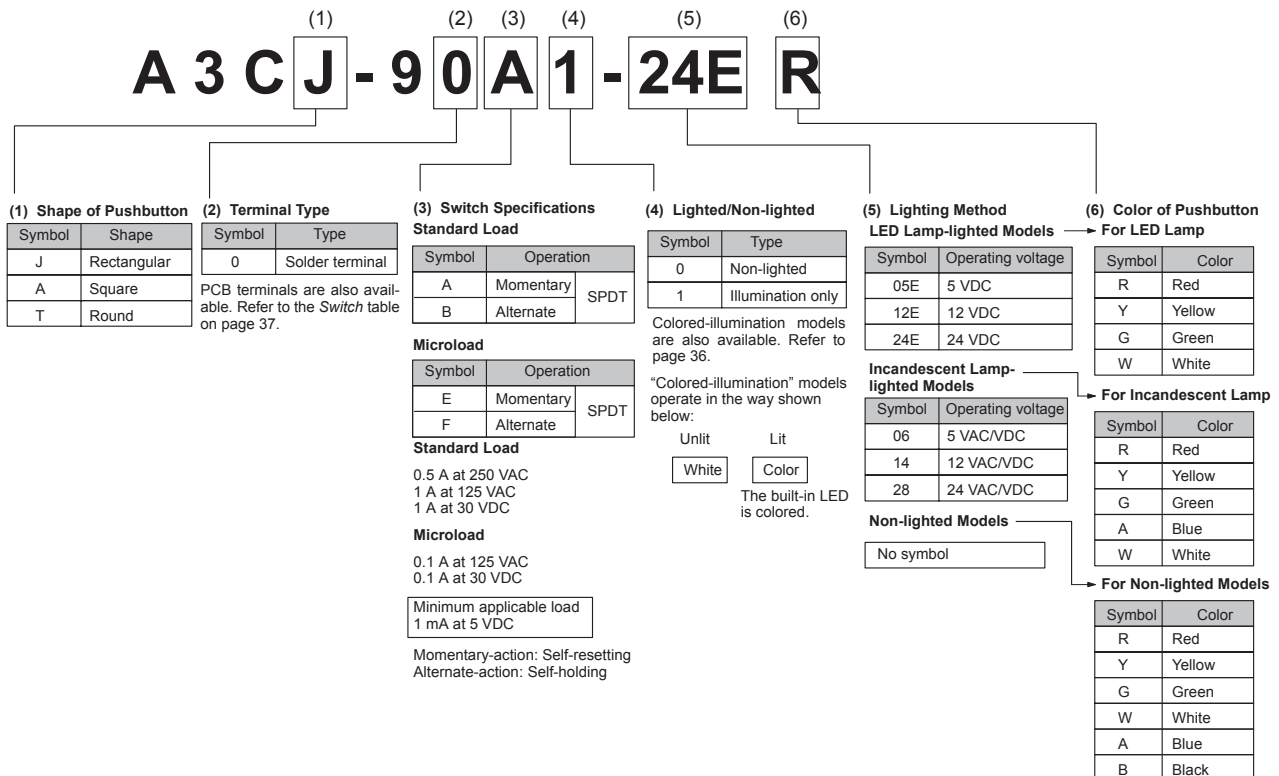

■ Ordering as a Set

The model numbers used to order sets of Units are given in the following tables. One set comprises the Pushbutton, Lamp (lighted models only), and Switch.

Rectangular Models

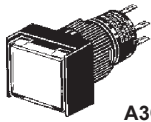

A3CJ

Square Models

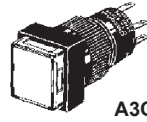

A3CA

Round Models

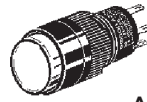

A3CT

Lighted Pushbutton Switches (SPST-NO+SPST-NC Solder Terminals)

Shape	Contact type Operation Lighting	Standard load		Microload	Pushbutton color symbol	
		Momentary operation (Self-resetting)	Alternate operation (Self-holding)	Momentary operation (Self-resetting)		
Rectangular (A3CJ)	LED lamp	A3CJ-90A1-05E□	A3CJ-90B1-05E□	A3CJ-90E1-05E□	R: red Y: yellow G: green W: white	
		A3CJ-90A1-12E□	A3CJ-90B1-12E□	A3CJ-90E1-12E□		
		A3CJ-90A1-24E□	A3CJ-90B1-24E□	A3CJ-90E1-24E□		
	Incandescent lamp	A3CJ-90A1-06□	---		A3CJ-90E0-□	R: red Y: yellow G: green W: white A: blue B: black (See note 3.)
		A3CJ-90A1-14□				
		A3CJ-90A1-28□				
	Non-lighted	A3CJ-90A0-□	A3CJ-90B0-□	A3CJ-90E0-□		
	Square (A3CA)	LED lamp	A3CA-90A1-05E□	A3CA-90B1-05E□	A3CA-90E1-05E□	R: red Y: yellow G: green W: white
			A3CA-90A1-12E□	A3CA-90B1-12E□	A3CA-90E1-12E□	
A3CA-90A1-24E□			A3CA-90B1-24E□	A3CA-90E1-24E□		
Incandescent lamp		A3CA-90A1-06□	---		A3CA-90E0-□	R: red Y: yellow G: green W: white A: blue B: black (See note 3.)
		A3CA-90A1-14□				
		A3CA-90A1-28□				
Non-lighted		A3CA-90A0-□	A3CA-90B0-□	A3CA-90E0-□		
Round (A3CT)		LED lamp	A3CT-90A1-05E□	A3CT-90B1-05E□	A3CT-90E1-05E□	R: red Y: yellow G: green W: white
			A3CT-90A1-12E□	A3CT-90B1-12E□	A3CT-90E1-12E□	
	A3CT-90A1-24E□		A3CT-90B1-24E□	A3CT-90E1-24E□		
	Incandescent lamp	A3CT-90A1-06□	---		A3CT-90E0-□	R: red Y: yellow G: green W: white A: blue B: black (See note 3.)
		A3CT-90A1-14□				
		A3CT-90A1-28□				
	Non-lighted	A3CT-90A0-□	A3CT-90B0-□	A3CT-90E0-□		

- Note:**
1. Enter the desired color symbol for the Pushbutton in the □ at the end of the model number.
 2. There are also alternate-operation models that can be used for microloads. Refer to the *Switch* table on page 37.
 3. Black ("B") Pushbuttons are only available for non-lighted models.

■ Illumination-only and Colored-illumination LED Models

“Illumination only” describes LED models for which the screen color is the same whether the LED is lit or not. The screen simply becomes brighter when the LED lights.

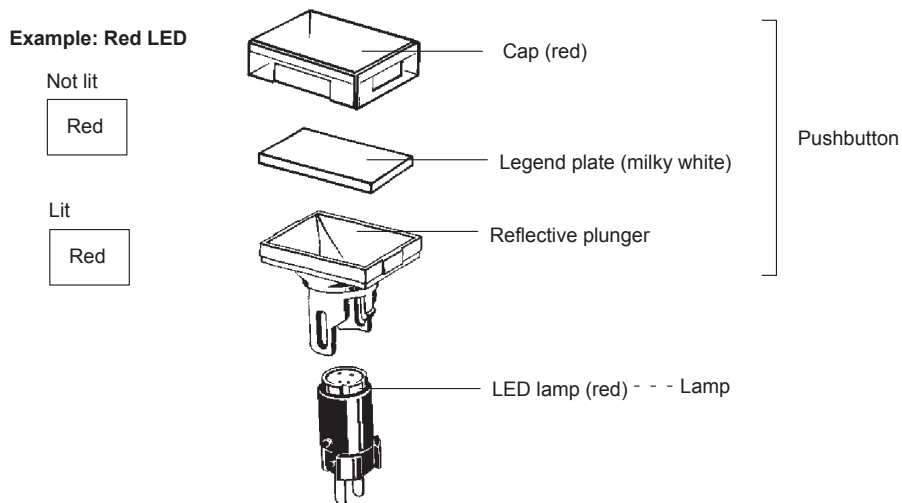

“Colored illumination” describes LED models for which the screen color is white when the LED is not lit and changes to the color of the LED lamp when the LED is lit.

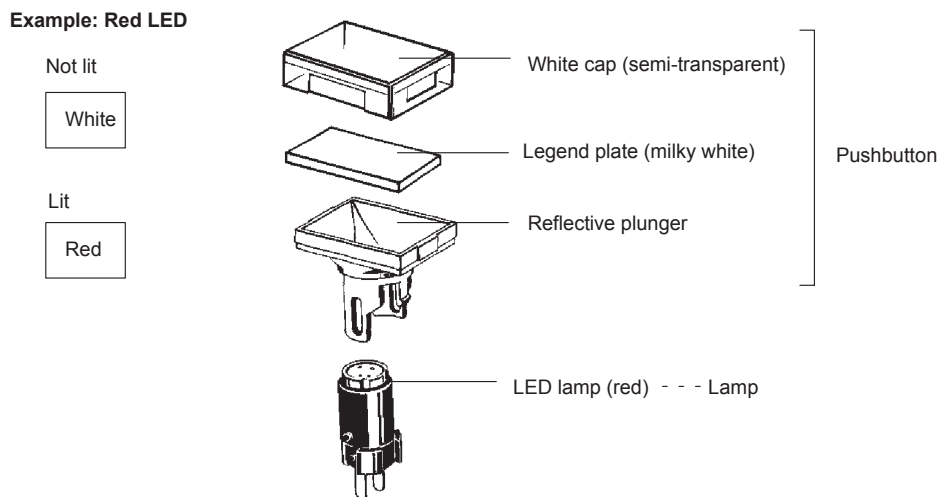

Ordering: With colored-illumination models, order the Pushbutton, Lamp, and Switch as shown in the following table.



Illuminated color	Pushbutton	Lamp (LED)		Switch
Red	IP40 A3C□-500W	A16-□DR	Enter one of the following symbols in □. 5: 5 VDC 12: 12 VDC 24: 24 VDC	Refer to the following information. Order the Switch that is appropriate for the Pushbutton.
Yellow	Enter one of the following symbols in □. J: Rectangular A: Square T: Round	A16-□DY		
Green		A16-□DG		

■ Ordering Individually

Pushbuttons, Lamps, and Switches can be ordered separately. Combinations that are not available as sets can be created using individual Units. Also, store the parts as spares for maintenance and repairs.

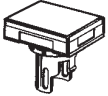

Pushbuttons

LED Lamp

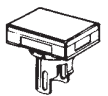

Button color	Rectangular	Square	Round
			
Red	A3CJ-500R	A3CA-500R	A3CT-500R
Yellow	A3CJ-500Y	A3CA-500Y	A3CT-500Y
Green	A3CJ-500GY	A3CA-500GY	A3CT-500GY
White	A3CJ-500W	A3CA-500W	A3CT-500W

Note: The red, yellow, and white Pushbuttons listed above can be used with either LED lamp-lighted models or incandescent lamp-lighted models.

Non-lighted Models

Button color	Rectangular	Square	Round
			
Red	A3CJ-500R	A3CA-500R	A3CT-500R
Yellow	A3CJ-500Y	A3CA-500Y	A3CT-500Y
Green	A3CJ-500G	A3CA-500G	A3CT-500G
White	A3CJ-500W	A3CA-500W	A3CT-500W
Blue	A3CJ-500A	A3CA-500A	A3CT-500A
Black	A3CJ-501B	A3CA-501B	A3CT-501B

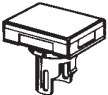
Incandescent Lamp

Button color	Rectangular	Square	Round
			
Red	A3CJ-500R	A3CA-500R	A3CT-500R
Yellow	A3CJ-500Y	A3CA-500Y	A3CT-500Y
Green	A3CJ-500G	A3CA-500G	A3CT-500G
White	A3CJ-500W	A3CA-500W	A3CT-500W
Blue	A3CJ-500A	A3CA-500A	A3CT-500A

Lamps



LED Lamp

Color	Rated voltage		
	5 VDC	12 VDC	24 VDC
Red	A16-5DR	A16-12DR	A16-24DR
Yellow	A16-5DY	A16-12DY	A16-24DY
Green	A16-5DG	A16-12DG	A16-24DG
White	A16-5DW	A16-12DW	A16-24DW









Incandescent Lamp

Rated voltage	6 VAC/VDC	14 VAC/VDC	28 VAC/VDC
Model	A16-5	A16-12	A16-24

Switches

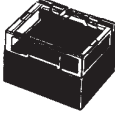
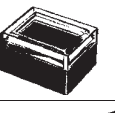
Configuration	Contact	Switch action	Terminal	Degree of protection: IP40		
				Rectangular	Square	Round
Standard	SPST-NO+ SPST-NC	Momentary	Solder			
		Alternate		A3CJ-7011	A3CA-7011	A3CT-7011
		Momentary		A3CJ-7021	A3CA-7021	A3CT-7021
		Alternate		A3CJ-7111	A3CA-7111	A3CT-7111
Microload				A3CJ-7121	A3CA-7121	A3CT-7121

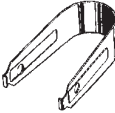
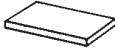
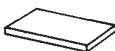
Accessories (Order Separately)

Name	Appearance	Classification	Model	Remarks
Socket		Wire-wrap terminal	A3C-4101	Cannot be used with Insulation Cover.
		PCB terminal	A3C-4102	
		Solder terminal	A3C-4103	
Insulation Cover		---	A3C-3002	Cannot be used with Socket.
Switch Guard		For rectangular models	A3CJ-5050	Cannot be used with Dust Cover.
		For square, round models	A3CA-5050	
Dust Cover		For rectangular models	A3CJ-5060	Cannot be used with Switch Guard.
Tightening Tool		---	A3C-3004	The tightening torque is 0.20 to 0.39 N·m.
Extractor		---	A3PJ-5080	---
Legend Plate		For rectangular models	A3CJ-5201	One Legend Plate is supplied per standard Switch.
		For square models	A3CA-5201	
		For round models	A3CT-5201	

Specifications

■ Contact Ratings

Model	Item	
	AC resistive load	DC resistive load
Standard load	0.5 A at 250 VAC 1 A at 125 VAC	1 A at 30 VDC
Microload (See note 1.)	0.1 A at 125 VAC	0.1 A at 30 VDC

- Note:**
- The minimum permissible load is 1 mA, 5 VDC.
 - The above ratings are for testing under the following conditions:
 - Load: Resistive load
 - Mounting conditions: No vibrations or shock
 - Temperature: 20°C ± 2°C
 - Operation frequency: 20 operations/minute

■ LED Lamp Ratings

Rated voltage	Rated current	Operating voltage	Internal limiting resistance
5 VDC	30 mA	5 VDC±5%	33 Ω
12 VDC	15 mA	12 VDC±5%	270 Ω
24 VDC	10 mA	24 VDC±5%	1,600 Ω

■ Incandescent Lamp Ratings

Rated voltage	Rated current	Operating voltage
6 VAC/VDC	60 mA	5 VAC/VDC
14 VAC/VDC	40 mA	12 VAC/VDC
28 VAC/VDC	24 mA	24 VAC/VDC

■ Characteristics

Operating frequency	Mechanical: Momentary-action models: 120 operations/minute max. Alternate-action models: 60 operations/minute max. (See note 1.) Electrical: 20 operations/minute max.
Insulation resistance	100 MΩ min. (at 500 VDC)
Dielectric strength	1,000 VAC, 50/60 Hz for 1 minute between terminals of same polarity and between lamp terminals (See note 2.) 2,000 VAC, 50/60 Hz for 1 minute between terminals of different polarity and also between each terminal and ground
Vibration	Malfunction: 10 to 55 Hz, 1.5-mm double amplitude (No malfunctions for more than 1 s.)
Shock	Destruction: 500 m/s ² Malfunction: 150 m/s ² (No malfunctions for more than 1 s.)
Life expectancy	Mechanical: Momentary-action models: 1,000,000 operations min. Alternate-action models: 100,000 operations min. (See note 1.) Electrical: 100,000 operations min.
Weight	Approx. 5 g (See note 3.)
Ambient operating temperature	-10°C to 55°C (with no icing or condensation)
Ambient operating humidity	35% to 85%
Ambient storage temperature	-25°C to 65°C
Degree of protection	IP40
Electric shock protection class	Class II
PTI (proof tracking index)	175
Pollution degree	3 (IEC947-5-1)

- Note:**
1. With alternate-operation models, one operation cycle consists of set and reset operations.
 2. The figure given above for the dielectric strength between lamp terminals is for when there is no LED lamp or incandescent lamp mounted.
 3. The weight indicated here applies to the lighted models (SPST-NO+SPST-NC).

■ Operating Characteristics

OF max.	2.45 N
RF min.	0.29 N
TT	Approx. 3.5 mm
LTA min. (See note.)	0.5 mm
PT max.	2.5 mm

Note: The value for LTA min. applies to alternate-operation models only.

■ Approved by Standards

UL (File No. E41515)
CSA (File No. LR45258-31)

Rating Standard

1 A at 125 VAC
0.5 A at 250 VAC
1 A at 30 VDC

Microload

0.1 A at 125 VAC
0.1 A at 30 VDC

■ Contact Form

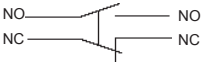
Contact name	Contact form
SPDT	

Nomenclature

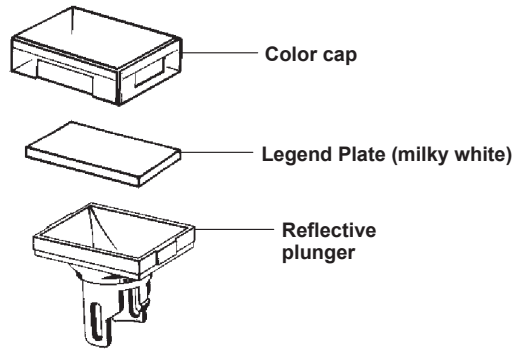

Pushbutton

Shape of Pushbutton

Rectangular
(A3CJ)



Square
(A3CA)



Round
(A3CT)

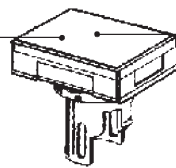

Color of Pushbutton

- LED lamp-lighted Models:
Red, yellow, green, white
- Incandescent lamp-lighted Models:
Red, yellow, green, white, blue
- Non-lighted Models:
Red, yellow, green, white, blue, black

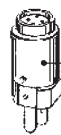

Lamp

LED Lamp



Incandescent Lamp

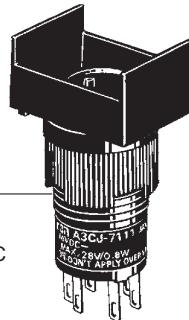

Switch

- Standard load:
0.5 A at 250 VAC
1 A at 125 VAC
1 A at 30 VDC
- Microload:
0.1 A at 125 VAC,
0.1 A at 30 VDC
Minimum applicable load: 1 mA at 5 VDC

Note: The A3CJ model is shown here as a representative example.

Dimensions

The following dimensions apply to the Switch with SPST-NO+SPST-NC contact configuration, with solder terminals.

Rectangular Models A3CJ

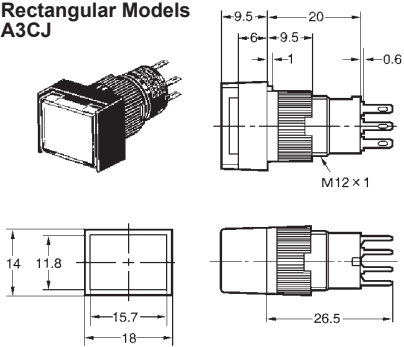

Square Models A3CA

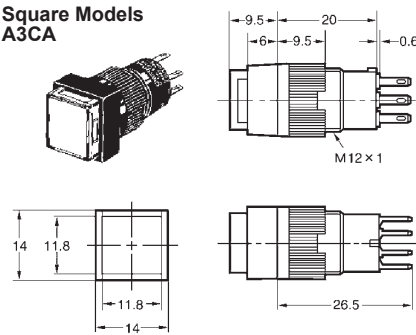

Round Models A3CT

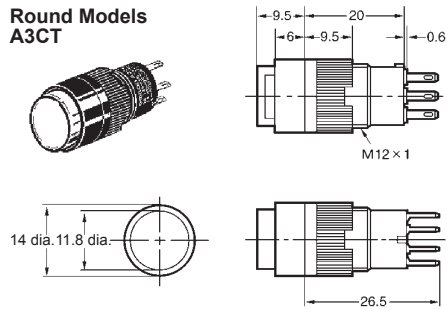

■ Accessory Mounting Dimensions Dimensions with Socket Mounted

The diagrams below show the external dimensions for rectangular models as representative models.

**Wire-wrap Terminal
A3C-4101**

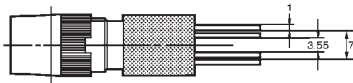
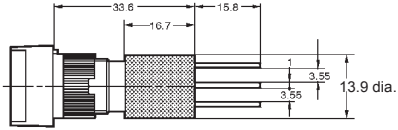

**PCB Terminal
A3C-4102**

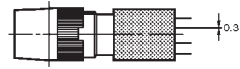
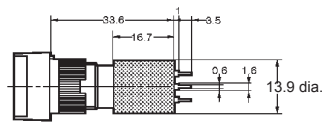

PCB Cutout (bottom view)

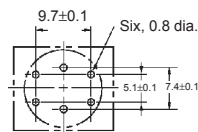

**Solder Terminal
A3C-4103**

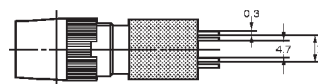
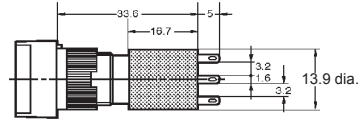

Terminal Hole Dimensions

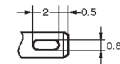

Switch Guard

**Rectangular
A3CJ-5050**

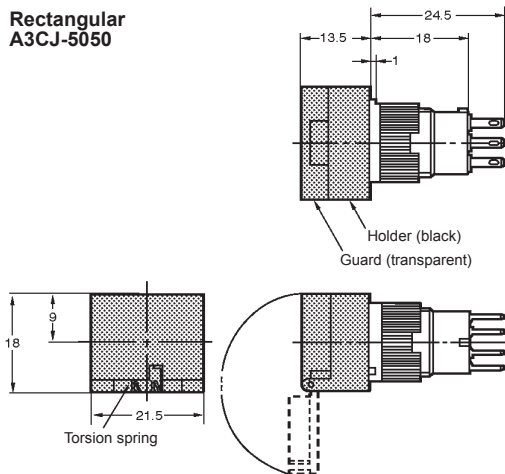

**Square/Round
A3CA-5050**

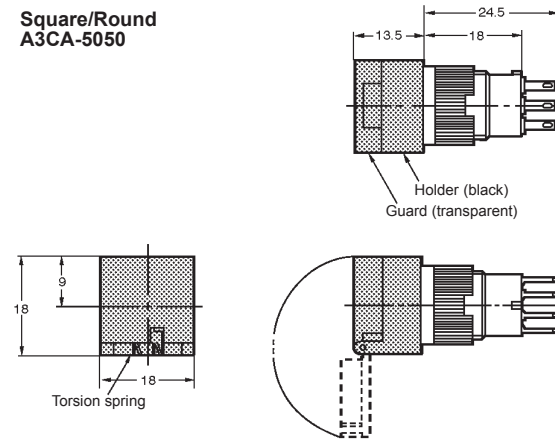

**Dust Cover
A3CJ-5060**

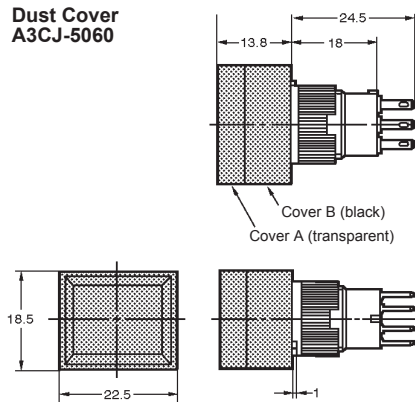

Legend Plate

Rectangular

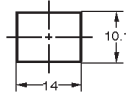

Square

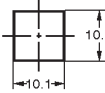

Round

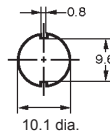

Note: 1. The thickness is 0.8 mm.

2. Since the Legend Plate is made of polycarbonate, use alcohol-based paints such as melanin, phthalic acid, or acryl paint when marking the legend.

**Insulation Cover
A3C-3002**

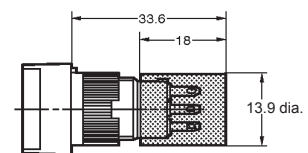

■ Panel Cutout (Top View)

Accessories used	Rectangular/A3CJ	Square/A3CA, Round/A3CT
Switch only	<p>Note: Recommended panel thickness: 1.0 to 3.2 mm.</p>	<p>Note: Recommended panel thickness: 1.0 to 3.2 mm.</p>
With Switch Guard		
With Dust Cover		---

Note: If the panel is to be finished (e.g., coated), make sure that the panel meets the specified dimensions after the coating.

Operation

■ Terminal Connections

Terminal	Type SPST-NO+SPST-NC
Solder terminal	<p>Lighted and non-lighted models</p>

Installation

Mounting and Replacing the Pushbutton

Mounting Direction for the Pushbutton/Display and Lamp

Lighted Pushbutton Switch

- Insert the Lamp (incandescent lamp or LED lamp) into the Pushbutton so that the lamp guide fits into the wider gap between the projections on the Pushbutton.

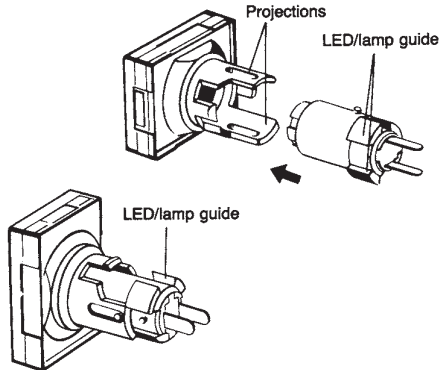

Indicator

- With Indicators, the Lamp is inserted facing the opposite direction (i.e., at 180°) to that for Lighted Pushbutton Switches.

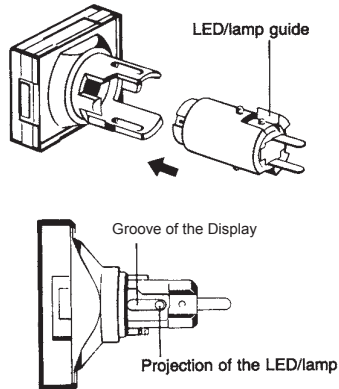

- Note:**
- Push the projections on the Lamp into the grooves on the Pushbutton/Display.
 - The Lamp for Lighted Pushbutton Switches moves, but the Lamp for Indicators is fixed.

Mounting Direction for the Pushbutton/Display and Switch

Insert the Pushbutton/Display into the Switch so that the lamp guide is aligned with the non-projecting part of the Switch.

Apply a pressure between 9.8 and 24.5 N.

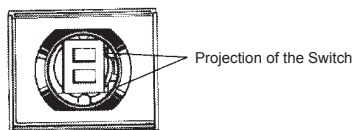

- Note:**
- The mounting direction for Indicators is 180° to that for Lighted Pushbutton Switches. Be sure to insert the Legend Plate and other parts with the correct orientation.

- If the terminals of the Lamp become bent, it may be impossible to fit them into the lamp terminal holes. Ensure that the terminals are straight when they are inserted.
- Take particular care about the mounting direction with the round models (A3CT).

Removing the Pushbutton/Display

Hold the recessed portions on the cap of the Pushbutton and pull.

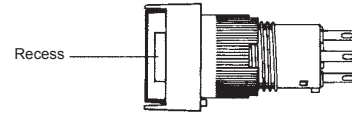

Note: Do not use tools such as pliers to remove the Pushbutton as this may damage the cap.

Panel Mounting

Insert the Switch from the front of the panel. Mount the mounting nut from the terminal end of the Switch and tighten it.

There are projections on the terminal end of the Switch which may, depending on the orientation, block the nut. In this case, turn the nut until it is possible to mount it. Tighten the nut to a torque between 0.20 and 0.39 N·m.

If soldering is used, mount the mounting nut first. Lead wires and mounds of solder may make it impossible to mount the nut after soldering.

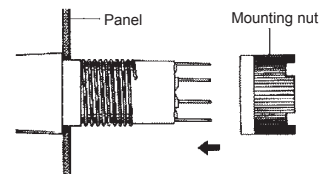

Socket Mounting

After securing the Switch to the panel using the mounting nut, insert the Socket into the Switch.

Align the positioning holes of the Socket with the projections of the Switch before inserting the Socket.

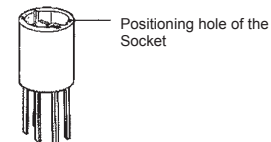
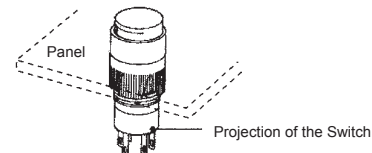

Mounting the Insulation Cover

After securing the Switch to the panel using the mounting nut, pass the lead wires through the holes in the Insulation Cover and then perform wiring. Hold the Insulation Cover so that the cylindrical hole is facing the Switch, and insert the lead wires from the end with the barriers.

After wiring is completed, mount the Insulation Cover by pushing it into the Switch.

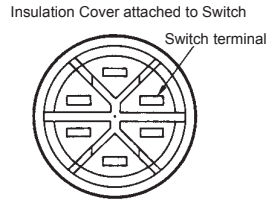

Mounting the Dust Cover

1. The Dust Cover separates into 2 parts: the cap and the mounting frame.
2. Insert the Switch into the mounting frame. (Align the lock projection with the recess on the mounting frame.)
3. Insert the Switch in the state described in step 2 into the panel. (Align the lock protrusion on the mounting frame with the hole in the panel.)
4. Mount the mounting nut from the back of the panel and tighten it.
5. Insert the cap into the mounting frame. Ensure that the entire perimeter of the cap is properly inserted into the mounting frame by pressing down on the cap from different directions.

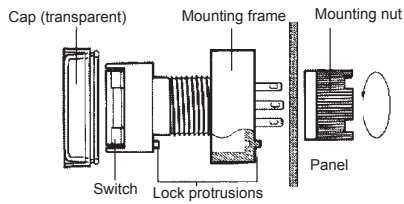

Mounting the Switch Guard

1. Insert the Switch into the Switch Guard.
2. Insert the Switch into the panel in the state described in step 1.
3. Mount the mounting nut from the back of the panel and tighten it.

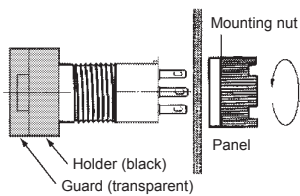

Precautions

Caution

Do not apply a voltage higher than the maximum rated operating voltage between the lamp terminals, as there is a risk that the incandescent lamp or LED lamp will be damaged, and the Pushbutton will be ejected.

When replacing the incandescent lamp, first turn OFF the power supply, and then wait 10 minutes before performing replacement, as the lamp is still hot immediately after the power is turned OFF, so there is a risk of burns.

Refer to the *Common Precautions* for Pushbutton Switches on page 14.

Correct Use

Mounting

To prevent electric shock or a fire, always make sure that the power is turned OFF before mounting, removing, or wiring the Switch, or performing maintenance.

Do not tighten the mounting ring excessively using pliers or a similar tool. Excessive tightening may damage the mounting ring. (Tightening torque: 0.20 to 0.39 N·m)

Wiring

When wiring, use wires of a size appropriate for the applied voltage and carry current. Perform soldering correctly under the conditions given below. Using the Switch with the wires soldered incorrectly may cause the terminals to become abnormally hot and cause a fire.

1. Hand soldering: At 30 W within 5 seconds.
2. Dip soldering: At 240°C within 3 seconds.

Wait for one minute after soldering before exerting any external force on the solder.

Use a non-corrosive rosin liquid for the flux.

Perform wiring so that the wire sheaths do not come into contact with the Switch. If this is unavoidable, use wires that can withstand temperatures of 100°C min.

After wiring to the Switch has been completed, ensure an appropriate insulation distance.

Operating Environment

Do not use in locations that are subject to dust, oil, or metal filings as these may penetrate the interior of the Switch and cause malfunction.

Using Microloads

Using a standard load switch for opening and closing a microload circuit may cause wear on the contacts. Use the switch within the operating range. (Refer to the diagram below.) Even when using microload models within the operating range shown below, if inrush current occurs when the contact is opened or closed, it may cause the contact surface to become rough, and so decrease life expectancy. Therefore, insert a contact protection circuit where necessary. The minimum applicable load is the N-level reference value. This value indicates the malfunction reference level for the reliability level of 60% ($\lambda 60$) (conforming to JIS C5003). The equation, $\lambda 60 = 0.5 \times 10^{-4}/\text{times}$ indicates that the estimated malfunction rate is less than 1/2,000,000 with a reliability level of 60%.

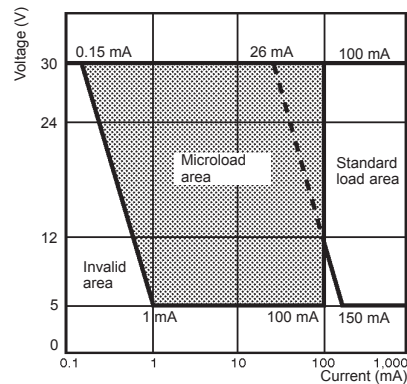

LED

Resistance to limit the LED current is provided internally and so an external resistance is not required.

Rated voltage	Internal limiting resistance
5 VDC	33 Ω
12 VDC	270 Ω
24 VDC	1600 Ω

ALL DIMENSIONS SHOWN ARE IN MILLIMETERS.

To convert millimeters into inches, multiply by 0.03937. To convert grams into ounces, multiply by 0.03527.

Common Precautions

For the individual precautions for a Switch, refer to the precautions in the section for that Switch.

Cautions

Do not perform wiring or touch the charged parts of terminals while power is being supplied to the Switch. Doing so may result in electric shock.

Electrical Characteristics

Electrical Conditions

- The switching load capacity of the Switch greatly varies between AC and DC. Always be sure to apply the rated load. The control capacity will drastically drop if it is a DC load. This is because a DC load has no current zero-cross point, unlike an AC load. Therefore, if an arc is generated, it may continue for a comparatively long time. Furthermore, the current direction is always the same, which results in a contact relocation phenomena whereby the contacts easily stick to each other and do not separate when the surfaces of the contacts are uneven.
- Some types of load have a great difference between normal current and inrush current. Make sure that the inrush current is within the permissible value. The greater the inrush current in the closed circuit is, the greater the contact abrasion or shift will be. Consequently, contact weld, contact separation failures, or insulation failures may result. Furthermore, the Switch may be broken or damaged.
- If the load is inductive, counter-electromotive voltage will be generated. The higher the voltage is, the higher the generated energy will be, which will increase the abrasion of the contacts and contact relocation phenomena. Be sure to use the Switch within the rated conditions.

Inrush Current

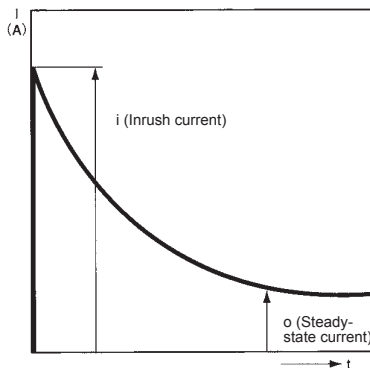

- Approximate control capacities are given in ratings tables, but these alone are insufficient to guarantee correct operation. For special types of load, with unusual switching voltage or current waveforms, test whether correct operation is possible with the actual load before application.
- When switching for microloads (voltage or current), use a Switch with microload specifications. The reliability of silver-plated contacts, which are used in Switches for standard loads, will be insufficient for microloads.
- When switching microloads or very high loads that are beyond the switching capacity of the Switch, connect a relay suitable for the load.

Type of Load vs. Inrush Current

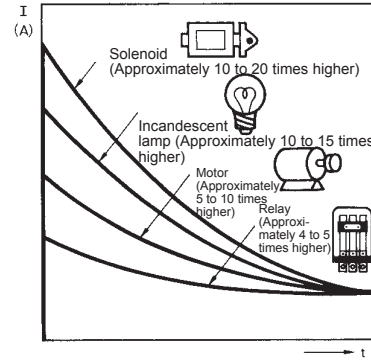

- All the performance ratings given are for operation under the following conditions unless otherwise specified.
 - Inductive load: A minimum power factor of 0.4 (AC) and a maximum time constant of 7 ms (DC)
 - Lamp load: An inrush current 10 times higher than the steady-state current
 - Motor load: An inrush current 6 times higher than the steady-state current

Note: Inductive loads can cause problems especially in DC circuitry. Therefore, it is essential to know the time constants (L/R) of the load.

Load Connections

Do not contact a single Switch to two power supplies that are different in polarity or type.

Connection of Different Polarities

The power supply may short-circuit if the loads are connected in the way shown in the "incorrect" example below.

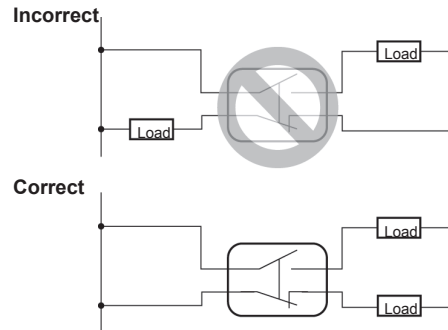

Even in the "correct" example, note that the insulation performance of the switch may deteriorate and the switch life may be shortened because loads are connected to both contacts.

Connection of Different Power Supplies

The DC and AC power may be mixed for the circuit shown below.

Do not design a circuit where voltage is imposed between contacts, otherwise contact weld may result.

Incorrect

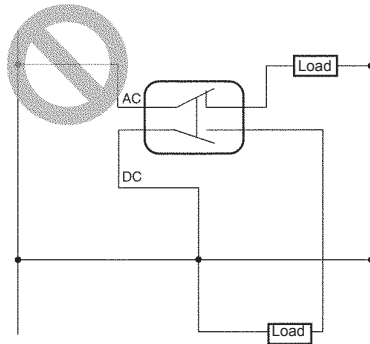

Incorrect

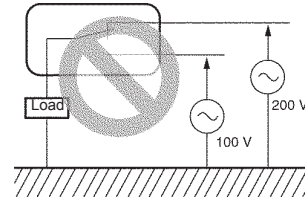

Contact Protective Circuit

Apply a contact protective circuit to extend the contact life, prevent noise, and suppress the generation of carbide or nitric acid. Be sure to apply the contact protective circuit correctly, otherwise an adverse effect may occur.

The following provides typical examples of contact protective circuits. If the Limit Switch is used in an excessively humid location for switching a load that easily generates arcs, such as an inductive load, the arcs may generate NO_x, which will change into HNO₃ if it reacts with moisture. Consequently, the internal metal parts may corrode and the Limit Switch may fail. Be sure to select the ideal contact preventive circuit from the following.

Typical Examples of Contact Protective Circuits

Circuit example	Applicable current		Feature	Element selection
	AC	DC		
	*	Yes	*When AC is switched, the load impedance must be lower than the CR impedance.	C: 1 to 0.5 μF x switching current (A) R: 0.5 to 1 Ω x switching voltage (V) The values may change according to the characteristics of the load. The capacitor suppresses the spark discharge of current when the contacts are open. The resistor limits the inrush current when the contacts are closed again. Consider the roles of the capacitor and resistor and determine ideal capacitance and resistance values through testing. Basically, use a capacitor with a dielectric strength between 200 and 300 V. When AC is switched, make sure that the capacitor has no polarity.
		Yes	Yes	
	No	Yes	Energy stored in the coil is changed into current by the diode connected in parallel to the load. Then the current flowing to the coil is consumed and Joule heat is generated by the resistance of the inductive load. The reset time delay with this method is longer than that in the CR method.	The diode must withstand a peak inverse voltage 10 times higher than the circuit voltage and a forward current as high or higher than the load current.
	No	Yes	This method will be effective if the reset time delay caused by the diode method is too long.	Use a Zener diode with a Zener voltage that is approximately 1.2 x power supply voltage as, depending on the environment, the load may not operate.
	Yes	Yes	This method makes use of constant-voltage characteristic of the varistor so that no high-voltage is imposed on the contacts. This method causes a reset time delay. Connecting a varistor in parallel to the load is effective when the supply voltage is 24 to 48 V and in parallel to the contacts when the supply voltage is 100 to 200 V.	---

Do not apply contact protective circuits as shown below.

Incorrect

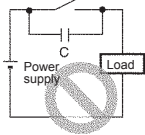

This circuit effectively suppresses arcs when the contacts are OFF. The capacitor will be charged, however, when the contacts are OFF. Consequently, when the contacts are ON again, short-circuited current from the capacitance may cause contact weld.

Incorrect

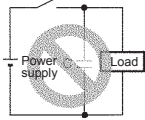

This circuit effectively suppresses arcs when the contacts are OFF. When the contacts are ON again, however, charge current will flow to the capacitor, which may result in contact weld.

Switching a DC inductive load is usually more difficult than switching a resistive load. By using an appropriate contact protective circuit, however, switching a DC inductive load will be as easy as switching a resistive load.

Switching

- Do not use the Switch for loads that exceed the rated switching capacity or other contact ratings. Doing so may result in contact weld, contact separation failures, or insulation failures. Furthermore, the Switch may be broken or damaged.
- Do not touch the charged switch terminals while power is supplied, otherwise an electric shock may be received.
- The life of the Switch varies greatly with switching conditions. Before using the Switch, be sure to test the Switch under actual conditions. Make sure that the number of switching operations is within the permissible range. If a deteriorated Switch is used continuously, insulation failures, contact weld, contact failures, switch damage, or switch burnout may result.
- Do not apply excessive or incorrect voltages to the Switch or incorrectly wire the terminals. Otherwise, the Switch may not function properly and have an adverse effect on external circuitry. Furthermore, the Switch itself may become damaged or burnt.
- Do not use the Switch in locations where flammable or explosive gases are present. Otherwise switching arcs or heat radiation may cause a fire or explosion.
- Do not drop or disassemble the Switch, otherwise it may not be capable of full performance. Furthermore, it may be broken or burnt.

Mechanical Conditions

Operating Force and Operating Method

- Fingertip operation is an important feature of Pushbutton Switches. In terms of Switch operation, Pushbutton Switches differ greatly from detection switches such as Microswitches. Operating the Switch using a hard object (e.g., metal), or with a large or sudden force, may deform or damage the Switch, resulting in faulty or rough operation, or shortening of the Switch life. The strength varies with the size and construction of the Switch. Use the appropriate Switch for the application after confirming the operating method and operating force with this catalog.

Incorrect

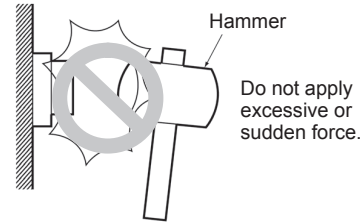

Do not apply excessive or sudden force.

- The pushbutton surface is composed of resin. Therefore, do not attempt to operate the pushbutton using a sharp object, such as a screwdriver or a pair of tweezers. Doing so may damage or deform the pushbutton surface and result in faulty operation.

Incorrect

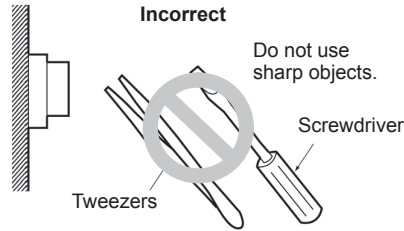

Do not use sharp objects.

Mounting

- Switches can be broadly divided into two categories according to mounting method: panel-mounting models and PCB-mounting models. Use the appropriate model for the mounting method required. Basically, panel-mounting Switches can withstand a greater operating force than PCB-mounting Switches. If, however, the panel thickness or the panel-cutout dimensions are not suitable for the Switch, it may not be able to withstand the normal operating force. With continuous mounting in particular, select a panel of a thickness that is easily sufficient to withstand the total operating force.
- Panel-mounting Switches can be divided into two categories according to the mounting method: snap-in mounting models and screw-mounting models. Snap-in mounting Switches are held in place with the elasticity of resin or a metal leaf spring. Do not attempt to modify the spring after mounting. Doing so may result in faulty operation or damage the mounting structure. Mount screw-mounting models using the screws and nuts provided (or individually specified). Tighten the screws to the specified torque. Mounting with different screws or nuts, or tightening beyond the specified torque may result in distortion of the inside of the case or damage to the screw section.

Snap-in Mounting

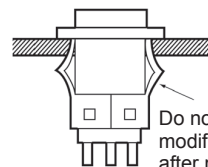

Do not attempt to modify the spring after mounting.

Screw Mounting

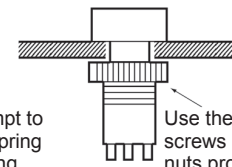

Use the screws and nuts provided (or specified).

- Subjecting the Switch to severe vibrations or shock may result in faulty operation or damage. Also, many of the Switches are

composed of resin so contact with sharp objects may result in damage to the surface. This kind of damage may spoil the appearance of the Switch or result in faulty operation. Do not throw or drop the Switch.

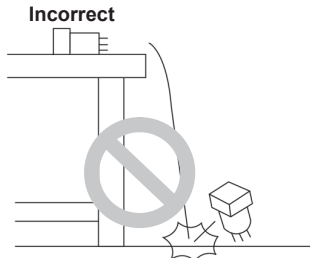

Do not drop or knock the Switch.

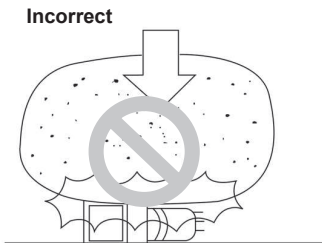

Do not drop objects or place heavy objects on the Switch.

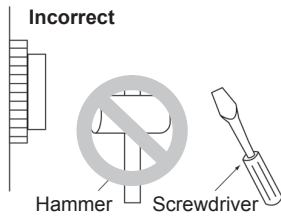

Do not operate the Switch with heavy or sharp objects.

Mounting Precautions

Wiring

- Perform wiring so that the lead wires will not be caught on other objects as this will cause stress on the Switch terminals. Wire the Switch so that there is slack in the lead wires and fix lead wires at intermediate points. If the panel to which the Switch is mounted needs to be opened and closed for maintenance purposes, perform wiring so that the opening and closing of the panel will not interfere with the wiring.

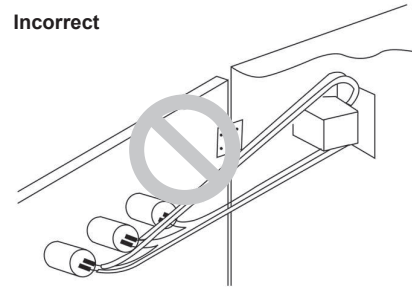
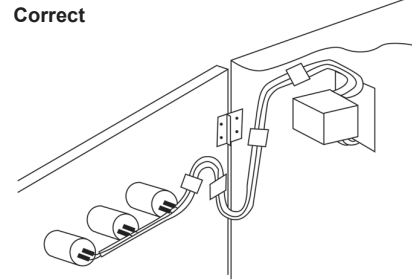

- With miniature Switches, the gap between the terminals is very narrow. Use protective or heat-absorbing tubes to prevent burning of the wire sheath or shorting.

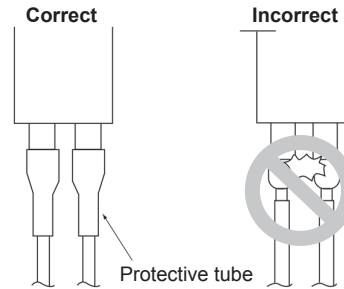

Soldering

- There are two methods for soldering the Switch: hand soldering and automatic soldering. In addition, automatic soldering itself can be divided into two types : dip soldering and reflow soldering. Use the soldering method appropriate for the mounting method.

The following table gives some examples of applications using the types of soldering given above.

Method		Soldering device	Application
Hand soldering		Soldering iron	Small quantities Different materials Lead wire terminals
Automatic soldering	Dip soldering	Jet soldering bath Dip soldering bath	Large quantities of discrete terminals
	Reflow soldering	Infrared reflow (IR) soldering bath Vapor-phase (VPS) reflow soldering bath	Large quantities of miniature SMD terminals

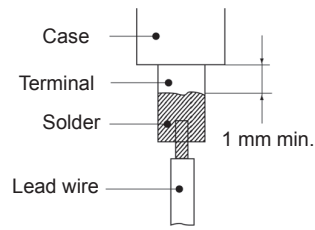

- Do not use soldering flux that contains chlorine. Doing so may result in metal corrosion.
- Perform hand soldering using the appropriate soldering iron.

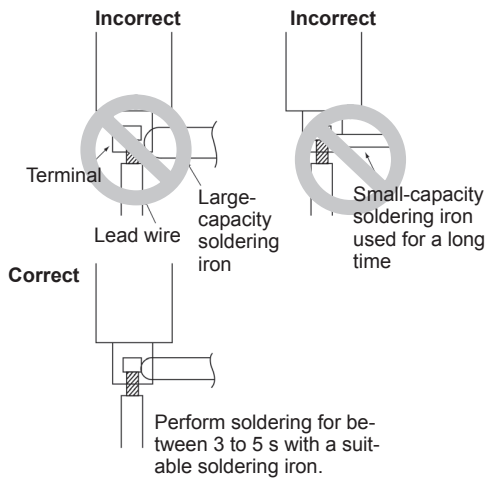

- With the exception of PCB-mounting Switches, when performing hand soldering, hold the Switch so that the terminals point downwards so that flux does not get inside the Switch.

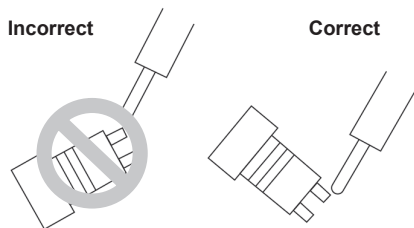

- Leave a gap of at least 1 mm between the soldered parts and the surface of the case so that flux does not get inside the Switch.

- When applying flux using a brush, use a sponge soaked in flux as shown below. Do not apply more than is necessary. Also, apply the flux with the PCB inclined at an angle of less than 80° so that flux does not flow onto the mounting surface of the Switch.

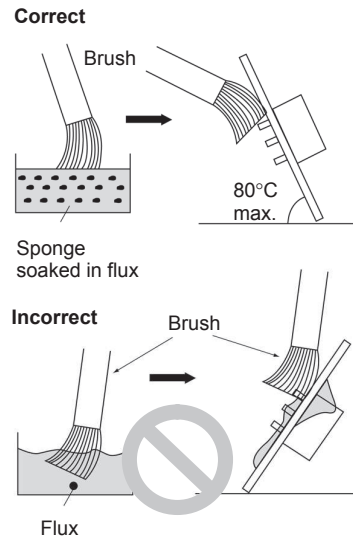

- Do not place PCBs that have had flux applied or have been soldered on top of each other. Otherwise, the flux on the PCB's solder surface may stain the upper part of the Switch or even permeate the inside of the Switch and cause contact failure.

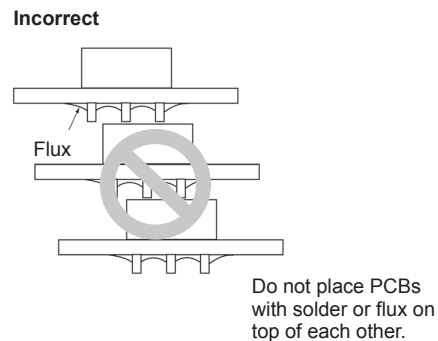

- When performing soldering with a dip soldering bath, ensure that the flux does not reach a higher level than the PCB.

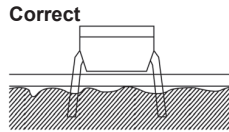
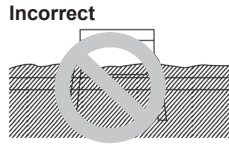

- Flux is especially likely to rise up at the edges of the PCB. If the Switch is mounted near the edge of the PCB, create a gap between the edge by using a split PCB, and insert the PCB in the soldering bath so that the edge that is farthest from the Switch enters the bath first.

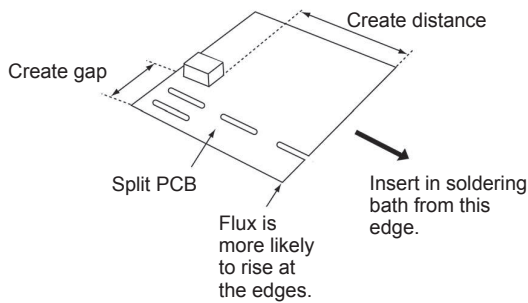

Storage

- When the Switch is left unused or stored for long periods, the ambient conditions can have a great effect on the condition of the Switch. In certain environments, leaving the Switch exposed may result in deterioration (i.e., oxidation, or the creation of an oxide film) of the contacts and terminals, causing the contact resistance to increase, and making it difficult to solder the lead wires. Therefore, store in a well-ventilated room, inside, for example, a non-hygroscopic case, in a location where no corrosive gases are present.

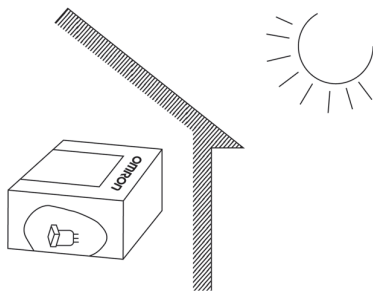

- If the Switch is stored in a location where it will be exposed to direct light, colored resin in the colored plate may fade. Therefore, do not store the Switch in locations where it will be exposed to direct light.



Artisan Technology Group is your source for quality new and certified-used/pre-owned equipment

- FAST SHIPPING AND DELIVERY
- TENS OF THOUSANDS OF IN-STOCK ITEMS
- EQUIPMENT DEMOS
- HUNDREDS OF MANUFACTURERS SUPPORTED
- LEASING/MONTHLY RENTALS
- ITAR CERTIFIED SECURE ASSET SOLUTIONS

SERVICE CENTER REPAIRS

Experienced engineers and technicians on staff at our full-service, in-house repair center

*InstraView*SM REMOTE INSPECTION

Remotely inspect equipment before purchasing with our interactive website at www.instraview.com ↗

WE BUY USED EQUIPMENT

Sell your excess, underutilized, and idle used equipment. We also offer credit for buy-backs and trade-ins. www.artisanng.com/WeBuyEquipment ↗

LOOKING FOR MORE INFORMATION?

Visit us on the web at www.artisanng.com ↗ for more information on price quotations, drivers, technical specifications, manuals, and documentation

Contact us: (888) 88-SOURCE | sales@artisanng.com | www.artisanng.com