



Artisan Technology Group is your source for quality new and certified-used/pre-owned equipment

- FAST SHIPPING AND DELIVERY
- TENS OF THOUSANDS OF IN-STOCK ITEMS
- EQUIPMENT DEMOS
- HUNDREDS OF MANUFACTURERS SUPPORTED
- LEASING/MONTHLY RENTALS
- ITAR CERTIFIED SECURE ASSET SOLUTIONS

SERVICE CENTER REPAIRS

Experienced engineers and technicians on staff at our full-service, in-house repair center

*InstraView*SM REMOTE INSPECTION

Remotely inspect equipment before purchasing with our interactive website at www.instraview.com ↗

WE BUY USED EQUIPMENT

Sell your excess, underutilized, and idle used equipment. We also offer credit for buy-backs and trade-ins. www.artisanng.com/WeBuyEquipment ↗

LOOKING FOR MORE INFORMATION?

Visit us on the web at www.artisanng.com ↗ for more information on price quotations, drivers, technical specifications, manuals, and documentation

Contact us: (888) 88-SOURCE | sales@artisanng.com | www.artisanng.com

C200H-AD001, C200H-AD002 ,
C200H-DA001, C200H-DA002
C200H-TM001

OMRON

SYSMAC - System C200H Special I/O Modules
– Analog Input / Output Modules

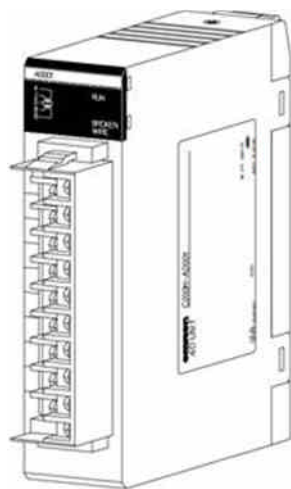

C200H-AD001

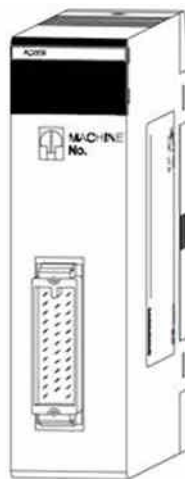

C200H-AD002

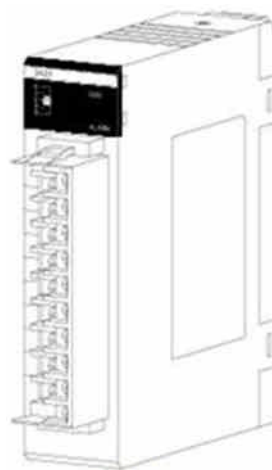

C200H-DA001

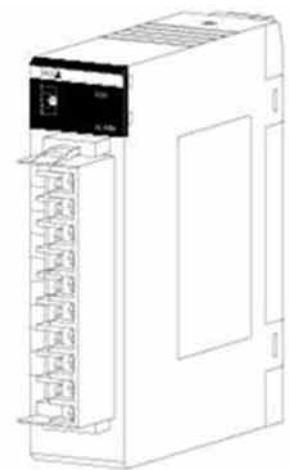

C200H-DA002

Presented by - MRO Electric and Supply Company, Inc.

For Product Needs:

Email: sales@MROELECTRIC.COM

Call: 1-800-691-8511

Fax: 919-415-1614

<http://www.MROELECTRIC.com/>

1

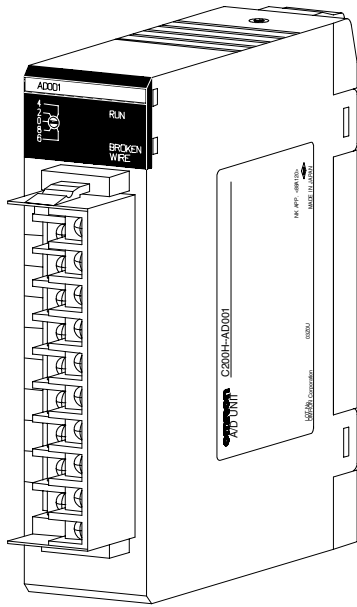

C200H-AD001

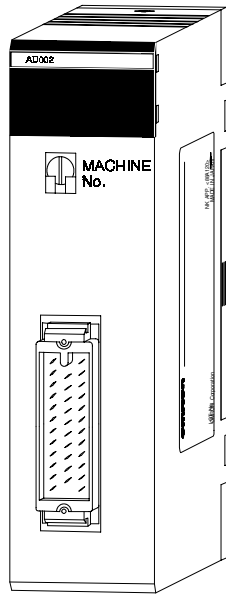

C200H-AD002

General Information

Analog I/O Modules provide an interface to a variety of analog signals including both voltage and current ranges. Both input and output versions are available in a variety of densities.

Features

- ◆ Cost-effective single-slot modules available with 4 or 8 analog inputs
- ◆ Opto-isolated input reliability
- ◆ 12-bit resolution
- ◆ Selectable ranges include 1 to 5 V, 0 to 10 V, and 4 to 20 mA

Specifications

Part number	C200H-AD001	C200H-AD002
Number of points	4	8
Signal ranges	Voltage	1-5 VDC or 0-10 VDC
	Current	4-20 mA
Intelligent functions	Input conversion	Input conversion, scaling, average, Peak hold, BCD, Upper and Lower limit alarm
Resolution	12-bit	12-bit
Accuracy	±1.0% maximum full scale, at 0°C -55°C ±0.1% maximum linearity error	±0.6% maximum full scale, at 0°C -55°C, for voltage input ±0.1% maximum linearity error
A/D conversion time	2.5 ms maximum/point	2.5 ms maximum/point
Input impedance	Voltage	1 MΩ minimum
	Current	250Ω
Manual	W127	W229

Typical Application

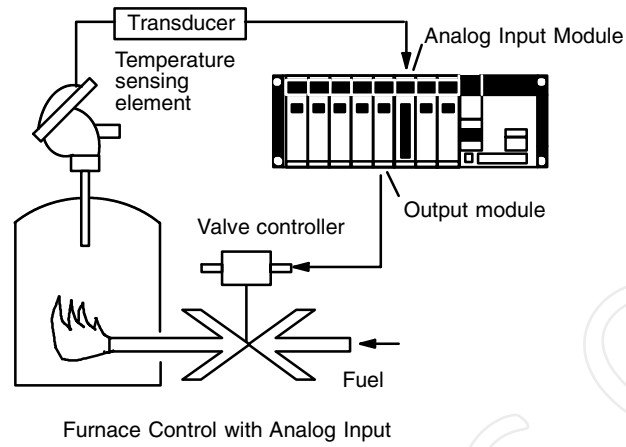

1

MROELECTRIC.COM

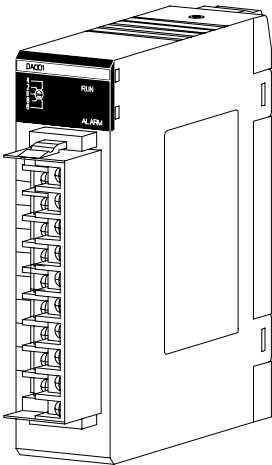

C200H-DA001

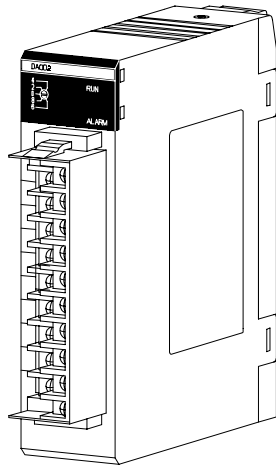

C200H-DA002

General Information

Analog I/O Module provides an interface to a variety of analog devices that accept voltage and current ranges.

Features

- ◆ Cost-effective single-slot module offers two or four analog outputs
- ◆ Selectable ranges include 1 to 5 V, 0 to 10 V, -10 to +10 V, and 4 to 20 mA

Specifications

Part number	C200H-DA001		C200H-DA002
Number of output points	2		4
Signal ranges	Voltage	1 to 5 V, 0 to 10 V	-10 to +10 V
	Current	4 to 20 mA	4 to 20 mA
Intelligent functions	Output limit, upper and lower limit alarms, pulse output		-
Resolution	Voltage	12-bit	13-bit
	Current	12-bit	12-bit
Accuracy	±1.0% maximum full scale, at 0°C -55°C		±1.0% maximum full scale, at 0°C -55°C
A/D conversion time	2.5 ms maximum/point		2.5 ms maximum/point
Input impedance	Max. Load	400 Ω	350 Ω
	Max. Load Current	15 mA	10 mA
Manual	W127		W260

Typical Application

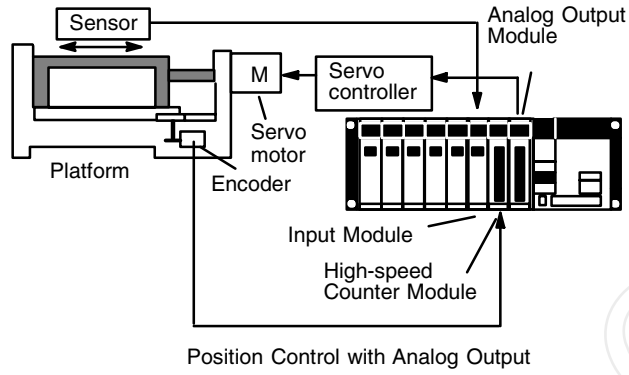

1

MROELECTRIC.COM

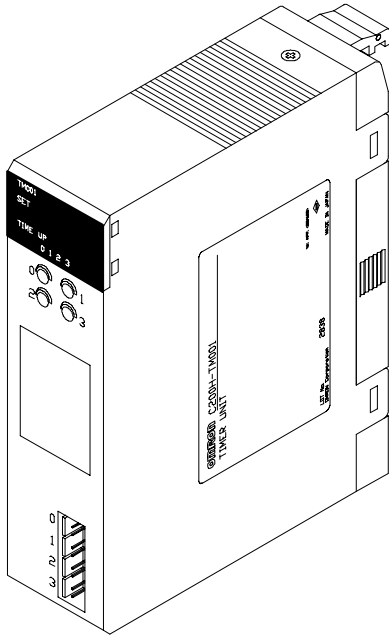

C200H-TM001

General Information

The analog timer module lets the user adjust timer values without going into the program. The module has four independently set and monitored timers that each have variable ranges. The user may select, by DIP switch, for each point to use front panel variable resistor or external variable resistors. Through internal bit allocation, each timer can be started and paused, allowing for them to be used as cumulative timers.

Features

- ◆ Four front panel variable resistors are used to set the timers
- ◆ Connections available for external variable resistors
- ◆ Indicators show operation and time-up status
- ◆ Cumulative timer available using pause bits

Specifications

Part number	C200H-TM001
Number of timers	4
Time setting range (DIP switch selectable)	Use the DIP switches to set any of the following 4 ranges: 0.1 to 1 second (typical) 1 to 10 seconds (typical) 10 to 60 seconds (typical) 1 to 10 minutes (typical)
Indicators	SET and TIME UP
Timer pause function	Timing can be paused if specified by program. The timers can be used as cumulative timers.
External variable resistor	External variable resistors can be used to set the time value when the IN/EXT selector is set to EXT.
Manual	C200H Installation Guide: W111

Typical Application

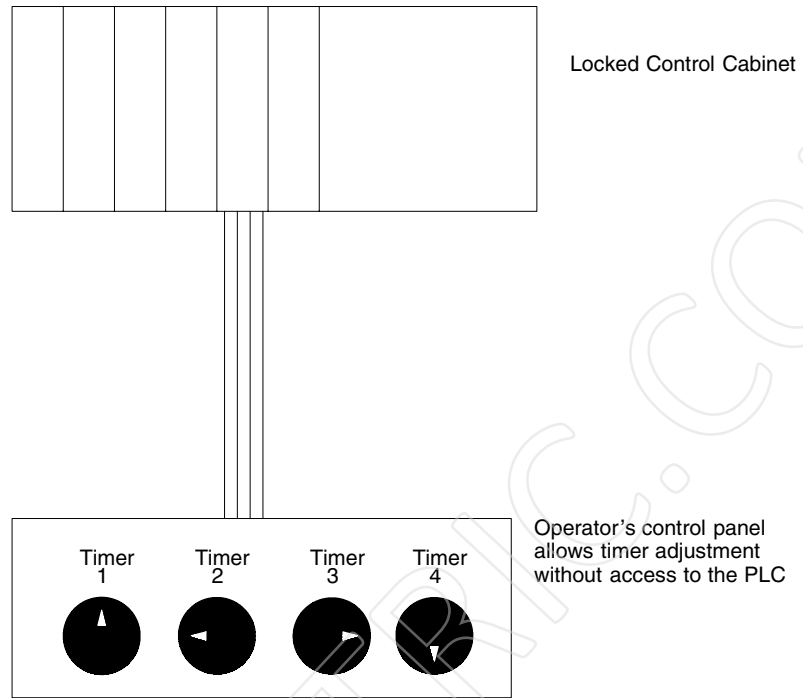

1

MROELECTRICALS.COM

System Configuration

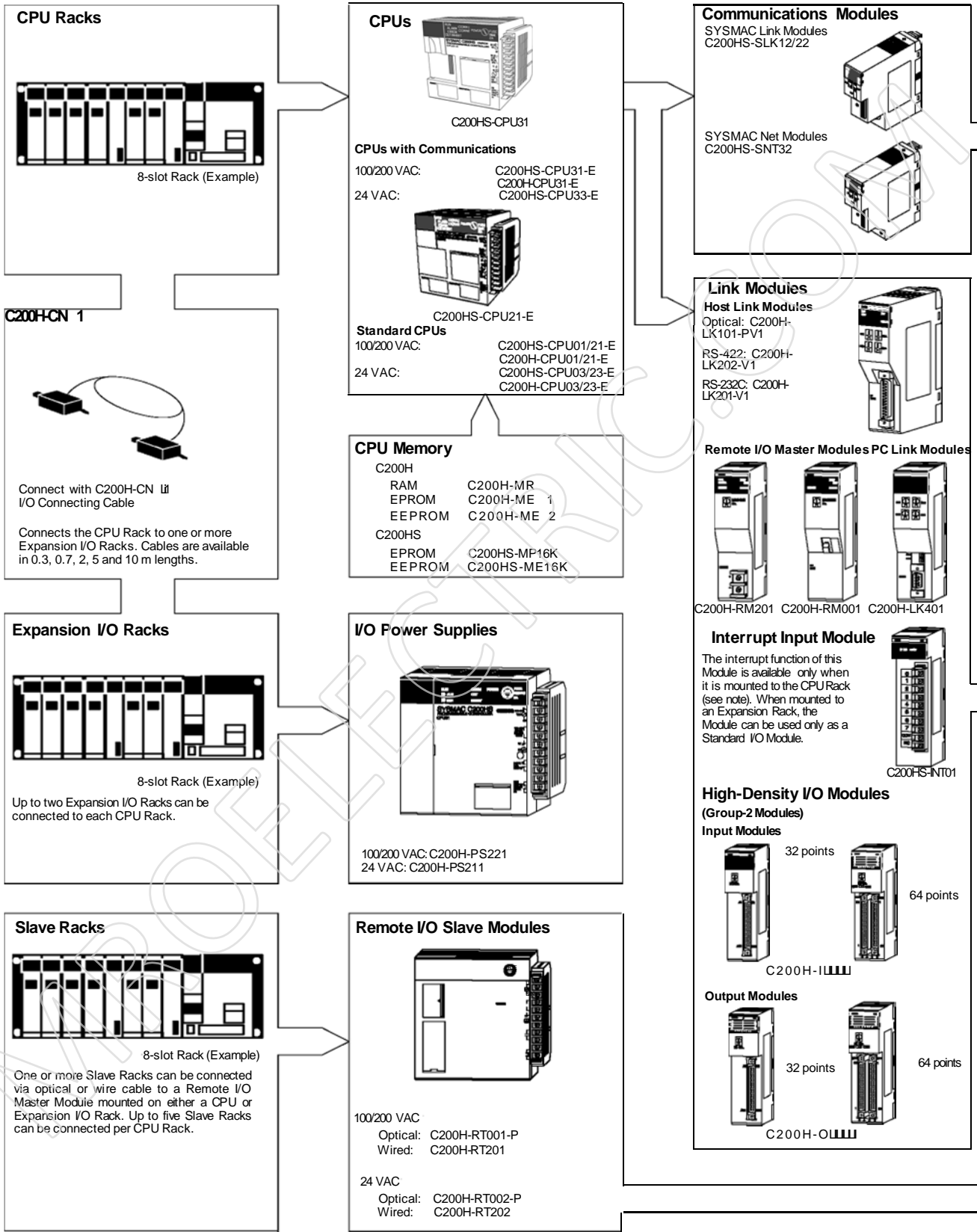

Note: Only one Interrupt Input Module can be used with a CPU.

System Configuration

Special I/O Modules

Analog Input Modules Analog Output Modules

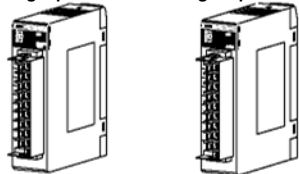

C200H-AD001/002 C200H-DA001

Temperature Sensor Modules

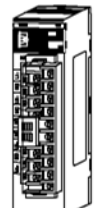

C200H-TS001

Temperature Control Modules



C200H-TC001

Fuzzy Logic Module

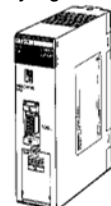

C200H-FZ001

PID Control Modules

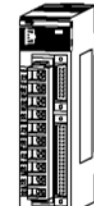

C200H-PID01

High Speed Counter Modules

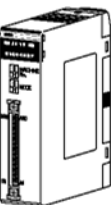

C200H-CT001

Position Control Modules



C200H-NCL01

Cam Position Modules



C200H-CP114

ID Sensor Module

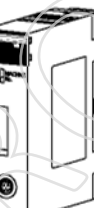

C200H-IDS01

ASCII Module Voice Module

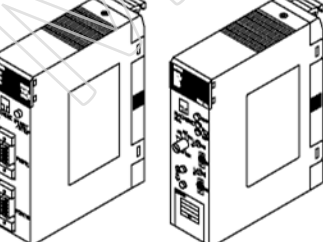

C200H-ASC02 C200H-OV001

I/O Modules

Input Modules (C200H-I0000)

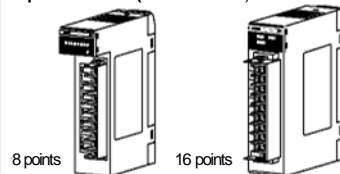

8 points 16 points
(AC, DC, AC/DC, transistor inputs)

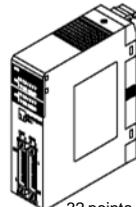

32 points
(Treated as Special I/O Module)

Output Modules (C200H-O0000)

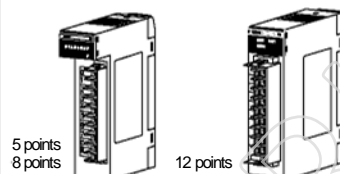

5 points 12 points
8 points

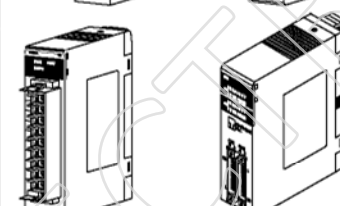

16 points 32 points
(Treated as Special I/O Module)

DC Input Transistor Output Modules

C200H-M0000
(16 inputs and 16 outputs; treated as Special I/O Module.)

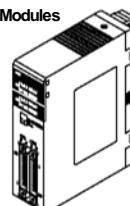

B7A Interface Modules

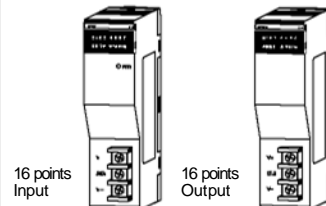

16 points Input 16 points Output
C200H-B7A11 C200H-B7A01

Analog Timer Module

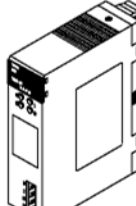

C200H-TM001

Backplanes

The same Backplanes are used for CPU, Expansion I/O, and Slave Packs.

3-slot Backplane

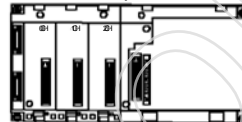

C200H-BC031-V2

5-slot Backplane

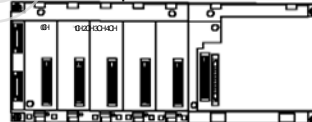

C200H-BC051-V2

8-slot Backplane



C200H-BC081-V2

10-slot Backplane

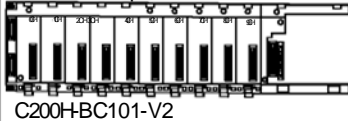

C200H-BC101-V2



Artisan Technology Group is your source for quality new and certified-used/pre-owned equipment

- FAST SHIPPING AND DELIVERY
- TENS OF THOUSANDS OF IN-STOCK ITEMS
- EQUIPMENT DEMOS
- HUNDREDS OF MANUFACTURERS SUPPORTED
- LEASING/MONTHLY RENTALS
- ITAR CERTIFIED SECURE ASSET SOLUTIONS

SERVICE CENTER REPAIRS

Experienced engineers and technicians on staff at our full-service, in-house repair center

*InstraView*SM REMOTE INSPECTION

Remotely inspect equipment before purchasing with our interactive website at www.instraview.com ↗

WE BUY USED EQUIPMENT

Sell your excess, underutilized, and idle used equipment. We also offer credit for buy-backs and trade-ins. www.artisanng.com/WeBuyEquipment ↗

LOOKING FOR MORE INFORMATION?

Visit us on the web at www.artisanng.com ↗ for more information on price quotations, drivers, technical specifications, manuals, and documentation

Contact us: (888) 88-SOURCE | sales@artisanng.com | www.artisanng.com