



Artisan Technology Group is your source for quality new and certified-used/pre-owned equipment

- FAST SHIPPING AND DELIVERY
- TENS OF THOUSANDS OF IN-STOCK ITEMS
- EQUIPMENT DEMOS
- HUNDREDS OF MANUFACTURERS SUPPORTED
- LEASING/MONTHLY RENTALS
- ITAR CERTIFIED SECURE ASSET SOLUTIONS

SERVICE CENTER REPAIRS

Experienced engineers and technicians on staff at our full-service, in-house repair center

*InstraView*SM REMOTE INSPECTION

Remotely inspect equipment before purchasing with our interactive website at www.instraview.com ↗

WE BUY USED EQUIPMENT

Sell your excess, underutilized, and idle used equipment. We also offer credit for buy-backs and trade-ins. www.artisanng.com/WeBuyEquipment ↗

LOOKING FOR MORE INFORMATION?

Visit us on the web at www.artisanng.com ↗ for more information on price quotations, drivers, technical specifications, manuals, and documentation

Contact us: (888) 88-SOURCE | sales@artisanng.com | www.artisanng.com

Mini Contactor Relays 4-Pole

- AC and DC operated
- 4-, 6- and 8-pole versions in different configurations
- Mirrored contacts
- Screw fixing and snap fitting (35 mm DIN rail)
- Rated current = 10A (I_{th})
- Suitable for electronic devices (DIN 19240)
- Finger proof (VBG 4)

Accessories

- 2- and 4-pole additional auxiliary contacts in different configurations



Specifications

Electrical	
Operating Coil	
Supply Power:	24 VDC, 110 VAC or 230 VAC
Inrush:	25 VA for AC versions 3 W for DC versions
Power Usage:	4.5 VA for AC versions 2.5 W for DC versions
Rated Carry Current:	10 A @ 40C
Switching Capability Inductive Loads (AC-15, DC-13)	
AC:	Break 120 V - 6 A, 240 V - 3 A (continuous 10 A)
DC:	24 V - 3 A
Max. Switching Frequency:	10,000 per hour
Min. Switching Current:	5 mA
Max. Drop-Out Time*:	8-25 ms for AC versions 8-25 ms for DC versions
Mechanical	
Mechanical Life:	1 x 10 ⁷ operations min.
Mounting:	35 mm DIN rail or 4 screw holes for panel mounting
Wire Size:	Screw terminals accept two 14 AWG solid or stranded wires
Weight:	AC versions: 160 g (5 oz.) DC versions: 190 g (6 oz.)
Vibration:	5 to 300 Hz
Environmental	
Vibration Resistance:	2 g with control relay open; 4 g with control relay closed
Operating Temperature:	-40 to 60°C (-40 to 140°F)
Approvals:	IEC947-5-1, VDE 0660, EN60947-5-1, UL508

*The Drop-Out Time is the time it takes for the N/O contacts to open after the coil voltage is turned OFF.
Specifications are subject to change without notice.

Approved Standards

Standard	Guide No. (US,C)
UL	NKCR, NKCR7
ICE 947-5-1	
VDE 0660	
EN 60947-5-1	

H

Dimensions

(mm)

AC and DC Operated with Screw Terminals

J7KNA-AR

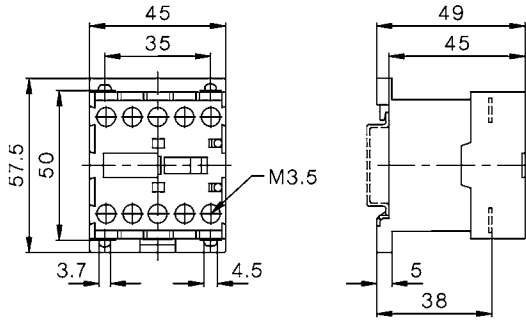

Auxiliary Contact Blocks

J73KN-A

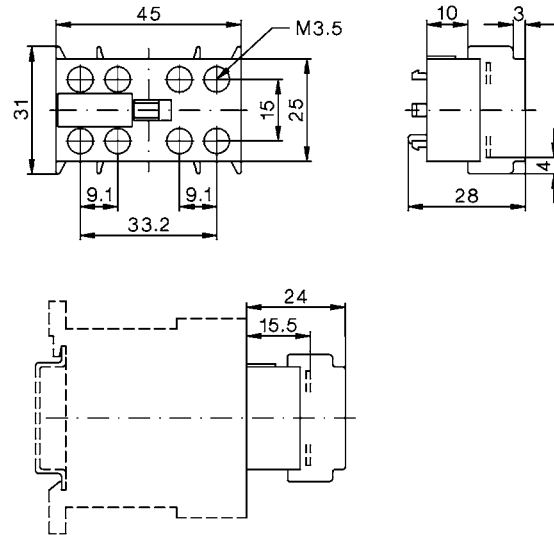

H

Contact Diagrams

Mini Contactor Relays, 4-Pole

J7KNA-AR-40

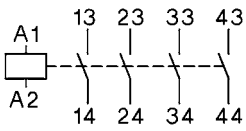

J7KNA-AR-31

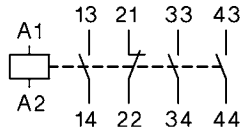

J7KNA-AR-22

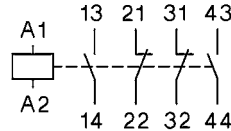

Auxiliary Contact Blocks for Contactor Relays J7KNA-AR

J73KN-A-11



J73KN-A-02

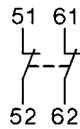

J73KN-A-40

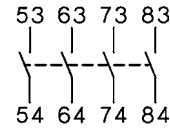

J73KN-A-22

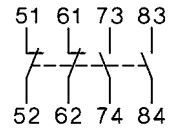

Mirror Contacts

Safety Function with Mirror Contacts

EN 60947-4-1 certification for mirror contact mechanisms has been obtained by using a combination of a relay and auxiliary contact blocks (5 VDC, 1 mA), enabling application in feedback circuits of safety circuits.

Application Example: General Safety Circuit

G9SA-301 (24-V AC/DC) (two limit switch input channels with manual reset)

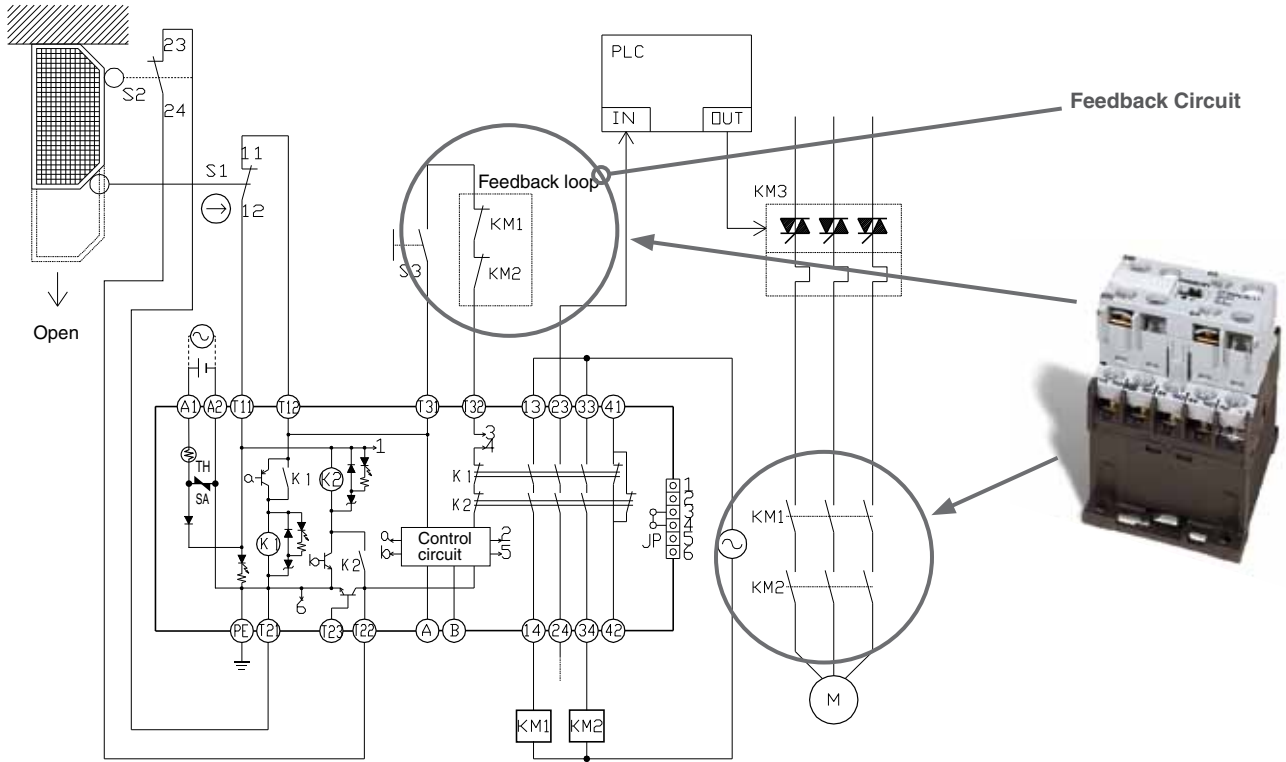

H

Mirror Contact Mechanism

By combining a Relay with an auxiliary contact block, all NC contacts of the auxiliary contact block will satisfy an impulse withstand voltage of 2.5 kV or higher or maintain a gap of 0.5 mm or greater when the coil is de-energized even if at least one NO contact (main contact) of the Relay is welded.

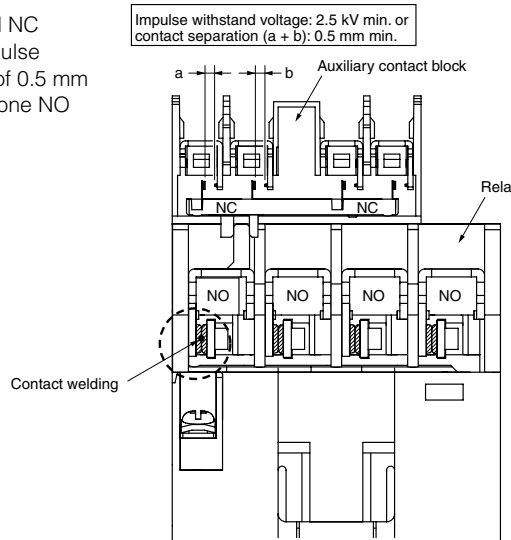

Ordering

Model Number Legend

Mini Contactor Relays

J7KNA – AR – □ – □
1 2

- 1** Combination of NO/NC Contacts
 - 22: 2 NO/2 NC
 - 31: 3 NO/1 NC
 - 40: 4 NO
 - 2** Coil Voltage (AC operated)
 - 24: AC 24 V 50/60 Hz
 - 110: AC 110-115 V 50 Hz, AC 120-125 V 60 Hz
 - 230: AC 220-230 V 50 Hz, AC 240 V 60 Hz
- Coil Voltage (DC operated)
 24VS: 24 VDC with suppression

Auxiliary Contact Modules for Mini Motor Contactor Relays

J73KN – A – □
1

- 1** Combination of NO/NC Contacts
 - 11: 1 NO/1 NC
 - 02: 2 NC
 - 22: 2 NO/2NC
 - 40: 4 NO

Model	Coil Voltage	Contacts	Part No.
AC Operated Relays			
J7KNA-AR-40 24	24 VAC	4 N/O	12010-4140
J7KNA-AR-31 24	24 VAC	3 N/O + 1 N/C	12010-4131
J7KNA-AR-22 24	24 VAC	2 N/O + 2 N/C	12010-4122
J7KNA-AR-40 110	110 VAC	4 N/O	12010-4240
J7KNA-AR-31 110	110 VAC	3 N/O + 1 N/C	12010-4231
J7KNA-AR-22 110	110 VAC	2 N/O + 2 N/C	12010-4222
J7KNA-AR-40 230	230 VAC	4 N/O	12010-4340
J7KNA-AR-31 230	230 VAC	3 N/O + 1 N/C	12010-4331
J7KNA-AR-22 230	230 VAC	2 N/O + 2 N/C	12010-4322
DC Operated Relays (coil suppression built -in)			
J7KNA-AR-40 24VS	24 VDC	4 N/O	12010-4040
J7KNA-AR-31 24VS	24 VDC	3 N/O + 1 N/C	12010-4031
J7KNA-AR-22 24VS	24 VDC	2 N/O + 2 N/C	12010-4022
Auxiliary Contact Modules			
J73KN-A-11		1 N/C + 1 N/O	12010-4411
J73KN-A-02		2 N/C	12010-4402
J73KN-A-40		4 N/O	12010-4440
J73KN-A-22		2 N/O + 2 N/C	12010-4422

= Highlighted **Rapid Delivery** products are available for shipment today or within **FIVE** days.

H



Artisan Technology Group is your source for quality new and certified-used/pre-owned equipment

- FAST SHIPPING AND DELIVERY
- TENS OF THOUSANDS OF IN-STOCK ITEMS
- EQUIPMENT DEMOS
- HUNDREDS OF MANUFACTURERS SUPPORTED
- LEASING/MONTHLY RENTALS
- ITAR CERTIFIED SECURE ASSET SOLUTIONS

SERVICE CENTER REPAIRS

Experienced engineers and technicians on staff at our full-service, in-house repair center

*InstraView*SM REMOTE INSPECTION

Remotely inspect equipment before purchasing with our interactive website at www.instraview.com ↗

WE BUY USED EQUIPMENT

Sell your excess, underutilized, and idle used equipment. We also offer credit for buy-backs and trade-ins. www.artisanng.com/WeBuyEquipment ↗

LOOKING FOR MORE INFORMATION?

Visit us on the web at www.artisanng.com ↗ for more information on price quotations, drivers, technical specifications, manuals, and documentation

Contact us: (888) 88-SOURCE | sales@artisanng.com | www.artisanng.com