



## Artisan Technology Group is your source for quality new and certified-used/pre-owned equipment

- FAST SHIPPING AND DELIVERY
- TENS OF THOUSANDS OF IN-STOCK ITEMS
- EQUIPMENT DEMOS
- HUNDREDS OF MANUFACTURERS SUPPORTED
- LEASING/MONTHLY RENTALS
- ITAR CERTIFIED SECURE ASSET SOLUTIONS

### SERVICE CENTER REPAIRS

Experienced engineers and technicians on staff at our full-service, in-house repair center

### *InstraView*<sup>SM</sup> REMOTE INSPECTION

Remotely inspect equipment before purchasing with our interactive website at [www.instraview.com](http://www.instraview.com) ↗

### WE BUY USED EQUIPMENT

Sell your excess, underutilized, and idle used equipment. We also offer credit for buy-backs and trade-ins. [www.artisanng.com/WeBuyEquipment](http://www.artisanng.com/WeBuyEquipment) ↗

### LOOKING FOR MORE INFORMATION?

Visit us on the web at [www.artisanng.com](http://www.artisanng.com) ↗ for more information on price quotations, drivers, technical specifications, manuals, and documentation

**Contact us:** (888) 88-SOURCE | [sales@artisanng.com](mailto:sales@artisanng.com) | [www.artisanng.com](http://www.artisanng.com)

# Thermal Overload Relay J7TKN

## Thermal Overload Relay

- Direct and separate mounting
- Single phasing sensivity according to IEC 947-4-1
- Finger proof ( VBG 4)

## Accessoires

- Busbar sets
- Set for single mounting



## Approved Standards

Standard	Guide No (US,C)
UL	NKCR, NKCR7
ICE 947-4-1	
VDE 0660	
EN 60947-4-1	

## Ordering Information

### ■ Model Number Legend

#### 1. Thermal Overload Relay

J7TKN-□-□□□  
1 2 3

- 1) Thermal Overload Relay
- 2) A: for mini motor contactor and motor contactor (4-11 kW)  
B: for motor contactor (4-15 kW)  
C: for motor contactor (18.5 kW)  
D: for motor contactor (22-37 kW)  
E: for motor contactor (45-55 kW)  
F: for motor contactor (75-110 kW)
- 3) Setting range (examples)  
E16: 0.12-0.16 A  
E27: 0.18-0.27 A  
...  
2E7: 1.8-2.7 A  
...  
11: 8-11 A





#### 2. Accessories for Thermal Overload Relay

J74TK-□-□□□  
1 2 3

- 1) Accessories for Thermal Overload Relay
- 2) SM: Single mounting for J7TKN-B Types (4-32 kW)  
SU: Busbar sets
- 3) 175: for J7TKN-F Types (75-90 kW)  
200: for J7TKN-F Types (110 kW)

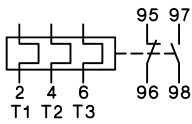

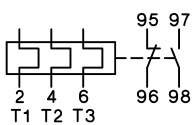
## ■ System overview

### Thermal Overload Relays for plug-in mounting

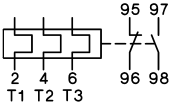
		Setting Range				Type	Pack	Weight	
		D.O.L.	(A)	Star Delta	(A)		pcs.	kg/pc.	
For contactors J7KNA-09..., J7KNA-12..., J7KN-10... to J7KN-22...									
	0.12	-	0.18	-	-	 hand reset	J7TKN-A-E18	1	0.10
	0.18	-	0.27	-	-		J7TKN-A-E27	1	0.10
	0.27	-	0.4	-	-		J7TKN-A-E4	1	0.10
	0.4	-	0.6	-	-		J7TKN-A-E6	1	0.10
	0.6	-	0.9	-	-		J7TKN-A-E9	1	0.10
	0.8	-	1.2	-	-		J7TKN-A-1E2	1	0.10
	1.2	-	1.8	-	-		J7TKN-A-1E8	1	0.10
	1.8	-	2.7	-	-		J7TKN-A-2E7	1	0.10
	2.7	-	4	-	-		J7TKN-A-4	1	0.10
	4	-	6	7	- 10.5		J7TKN-A-6	1	0.10
	6	-	9	10.5	- 15.5		J7TKN-A-9	1	0.10
	8	-	11	14	- 19		J7TKN-A-11	1	0.10
	10	-	14	18	- 24		J7TKN-A-14	1	0.10
	13	-	18	23	- 31		J7TKN-A-18	1	0.10
17	-	23	30	- 40	J7TKN-A-23	1	0.10		
22	-	30	38	- 52	J7TKN-A-30	1	0.10		
For contactors J7KN-10... to J7KN-40...									
	0.12	-	0.18	-	-	 hand- and auto reset	J7TKN-B-E18	1	0.14
	0.18	-	0.27	-	-		J7TKN-B-E27	1	0.14
	0.27	-	0.4	-	-		J7TKN-B-E4	1	0.14
	0.4	-	0.6	-	-		J7TKN-B-E6	1	0.14
	0.6	-	0.9	-	-		J7TKN-B-E9	1	0.14
	0.8	-	1.2	-	-		J7TKN-B-1E2	1	0.14
	1.2	-	1.8	-	-		J7TKN-B-1E8	1	0.14
	1.8	-	2.7	-	-		J7TKN-B-2E7	1	0.14
	2.7	-	4	-	-		J7TKN-B-4	1	0.14
	4	-	6	7	- 10.5		J7TKN-B-6	1	0.14
	6	-	9	10.5	- 15.5		J7TKN-B-9	1	0.14
	8	-	11	14	- 19		J7TKN-B-11	1	0.14
	10	-	14	18	- 24		J7TKN-B-14	1	0.14
	13	-	18	23	- 31		J7TKN-B-18	1	0.14
17	-	24	30	- 41	J7TKN-B-24	1	0.14		
23	-	32	40	- 55	J7TKN-B-32	1	0.14		
For contactors J7KN-24... to J7KN-40...									
	28	-	42	48	- 73	J7TKN-C-42	1	0.30	

	Setting Range		Type	Pack pcs.	Weight kg/pc.	
	D.O.L. (A)	Star Delta (A)				
<b>For contactors J7KN-50...-J7KN-74...</b>						
	40 - <b>52</b>	70 - 90		<b>J7TKN-D-52</b>	1	0.40
	52 - <b>65</b>	90 - 112		<b>J7TKN-D-65</b>	1	0.40
	60 - <b>74</b>	104 - 128		<b>J7TKN-D-74</b>	1	0.40

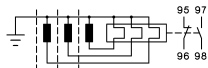
**Thermal Overload relays for separate mounting**

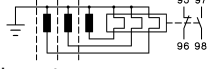
	Setting Range		Type	Pack pcs.	Weight kg/pc.	
	D.O.L. (A)	Star Delta (A)				
<b>For contactors J7KN-85... to J7KN-150...</b>						
	60 - <b>90</b>	104 - 156	 hand reset	<b>J7TKN-E-90</b>	1	0.90
	80 - <b>120</b>	140 - 207		<b>J7TKN-E-120</b>	1	0.90
<b>For contactors J7KN-175... to J7KN-200...</b>						
	100 - <b>150</b>	175 - 260	 hand reset	<b>J7TKN-F-150</b>	1	1.5
	140 - <b>220</b>	240 - 380 busbar sets see accessories		<b>J7TKN-F-210</b>	1	1.5

**Accessories**

	for overload relays	for contactors	Type	Pack pcs.	Weight kg/pc.
<b>Busbar Sets</b>					
	J7TKN-F-175	J7KN-150, J7KN-175	<b>J73TK-SU-175</b>	1	0.6
	J7TKN-F-210	J7KN-200	<b>J73TK-SU-200</b>	1	0.7
	busbars must be installed by users				

	for overload relay	Cable Cross-section to clamp (mm <sup>2</sup> )			Type	Pack pcs.	Weight kg/pc.
		solid or stranded	flexible	flex. with multicore cable end			
<b>Sets for single mounting</b>							
	U3/32	0.75 - 6	0.75 - 4	0.5 - 4	<b>J73TK-SM</b>	1	0.035

# Specifications

## Engineering data and Characteristics

**Thermal Overload Relays, tripping times for selection to motors of protection degree EEx e Relays With Standard Tripping Characteristic**

Setting Range		Tripping time depending on the multiple of the current setting from cold condition (tolerance ±20% of the tripping time)					
A	A	$I_A/I_N$	$I_A/I_N$	$I_A/I_N$	$I_A/I_N$	$I_A/I_N$	$I_A/I_N$
<b>J7TKN-A-...</b>		s	s	s	s	s	s
0,12	- <b>0,18</b>	18,5	10,4	7,2	5,5	4,3	<b>3,6</b>
0,18	- <b>0,27</b>	16,7	9,8	6,5	5	4,1	<b>3,5</b>
0,27	- <b>0,4</b>	19,4	12,1	8,2	5,9	4,9	<b>4,2</b>
0,4	- <b>0,6</b>	18,7	11,2	8	6	4,9	4,1
0,6	- <b>0,9</b>	19,7	11,6	8,1	6,1	4,9	<b>4,2</b>
0,8	- <b>1,2</b>	22,9	13,6	10	7,3	6	<b>5,2</b>
1,2	- <b>1,8</b>	22,2	13,2	9,2	7,6	5,8	<b>5,3</b>
1,8	- <b>2,7</b>	23	13,7	9,3	7,6	5,7	<b>5,1</b>
2,7	- <b>4</b>	24	14,4	9,9	7,8	5,9	5,1
4	- <b>6</b>	24,7	13,8	9,9	7,3	5,6	4,8
6	- <b>9</b>	22	13,4	8	5,7	4,1	3,5
8	- <b>11</b>	17,4	9,2	5,9	4,1	2,9	2,3
10	- <b>14</b>	26,4	12,9	7,6	5,2	3,5	2,8
13	- <b>18</b>	14,7	7,7	4,8	3,2	2,3	1,7
17	- <b>23</b>	16,2	8,4	5	3,6	2,4	1,8
22	- <b>30</b>	16,8	8,5	5	3,6	2,3	1,9
<b>J7TKN-C-42</b>		s	s	s	s	s	s
28	- <b>42</b>	25,2	13,3	8	5,5	4	3,1
<b>J7TKN-D-...</b>		s	s	s	s	s	s
40	- <b>52</b>	18,3	9,2	5,6	3,9	2,8	2,2
52	- <b>65</b>	17,8	8,7	5,2	3,4	2,5	1,9
60	- <b>74</b>	19,5	13,5	11	10	9,5	8,5
<b>J7TKN-E-...</b>		s	s	s	s	s	s
60	- <b>90</b>	19,5	13,5	11	10	9,5	8,5
80	- <b>120</b>	18	11	10	9	8,5	8
<b>J7TKN-F-...</b>		s	s	s	s	s	s
100	- <b>150</b>	34	26	24	20,5	19	<b>18</b>
140	- <b>210</b>	30	24	21	18,5	17	<b>16</b>

All tripping times of overload relays J7TKN-A are shorter than the minimum values of the  $t_E$  time for motors of protection degree EEx e acc. to EN 50019 and therefore are suitable for all motors of protection degree EEx e. For these overload relays the selection on basis of tripping curves is thereby not necessary.

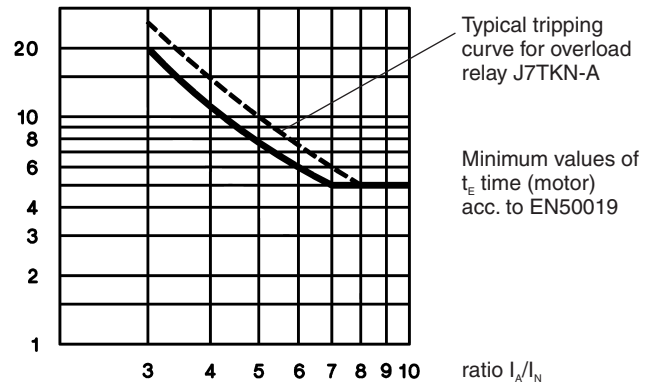

Labels of tripping curves for each setting range, sized 148x105mm (self-adhesive) are available on request. Specify type and setting range.

When selecting a standard overload, refer to the tripping curve. Determine the values of the starting current ratio  $I_A/I_N$  and the time  $t_E$  which is marked on the label of the motor. The overload must trip within the  $t_E$  time, which means that the tripping curve from cold condition must be (20% due to tolerance) below the coordination point  $I_A/I_N$  and the time  $t_E$ .

$I_A$  = Starting current of motor

$I_N$  = Rated current of motor

$t_E$  =  $t_E$ -time of motor

**Fuses for J7TKN-A; J7TKN-B; J7TKN-C; J7TKN-D; J7TKN-E; J7TKN-F**

Type	Setting Range				Max. Fuse Size According to Coordination-type				Fuse UL		
	DOL		Star Delta		"2" <sup>*1</sup> quick	slow, gL(gG)	"1" <sup>*1</sup> slow, gL(gG)	aM			
	A		A		A	A	A	A			
<b>J7TKN-A</b>	0.12	-	<b>0.18</b>	-	-	0.5 <sup>*2</sup>	0.5 <sup>*2</sup>	25	-	15	
<b>J7TKN-B</b>	0.18	-	<b>0.27</b>	-	-	1.0 <sup>*2</sup>	1.0 <sup>*2</sup>	25	-	15	
	0.27	-	<b>0.4</b>	-	-	2	2	25	-	15	
	0.4	-	<b>0.6</b>	-	-	2	2	25	-	15	
	0.6	-	<b>0.9</b>	-	-	4	4	25	-	15	
	0.8	-	<b>1.2</b>	-	-	4	4	25	2	15	
	1.2	-	<b>1.8</b>	-	-	6	6	25	2	15	
	1.8	-	<b>2.7</b>	-	-	10	10	25	4	15	
	2.7	-	<b>4</b>	-	-	16	10	25	4	15	
	4	-	<b>6</b>	7	-	10.5	20	16	25	6	15
	6	-	<b>9</b>	10.5	-	15.5	35	25	35	10	25
	8	-	<b>11</b>	14	-	19	35	25	35	16	30
	10	-	<b>14</b>	18	-	24	50	35	63	16	40
	13	-	<b>18</b>	23	-	31	50	35	63	20	50
	17	-	<b>(23)24</b>	30	-	(40)41	63	50	63	25	60
	(22)23	-	<b>(30)32</b>	(38)40	-	(52)55	80	63	80	35	70
<b>J7TKN-C</b>	28	-	<b>42</b>	48	-	73	100	80	150	50	110
<b>J7TKN-D</b>	40	-	<b>52</b>	70	-	90	160	100	150	63	200
	52	-	<b>65</b>	90	-	112	160	125	150	80	250
	60	-	<b>74</b>	104	-	128	160	125	150	80	250
<b>J7TKN-E</b>	60	-	<b>90</b>	104	-	156	For short circuit protecting overload relays with current transformer use fuse according to the contactor of the combination.			300	
	80	-	<b>120</b>	140	-	207				-	
<b>J7TKN-F</b>	all ranges									-	

\*1) Coordination-type according to IEC 947-4-1:

„2“: Light contact welding accepted. Thermal overload relay must not be damaged.

„1“: Welding of contactor and damage of the thermal overload relay allowed.

\*2) Miniature fuse

### Tripping Characteristics for J7TKN-A, J7TKN-B, J7TKN-C, J7TKN-D

Detailed tripping times for each range see table page 54

with three-phase load

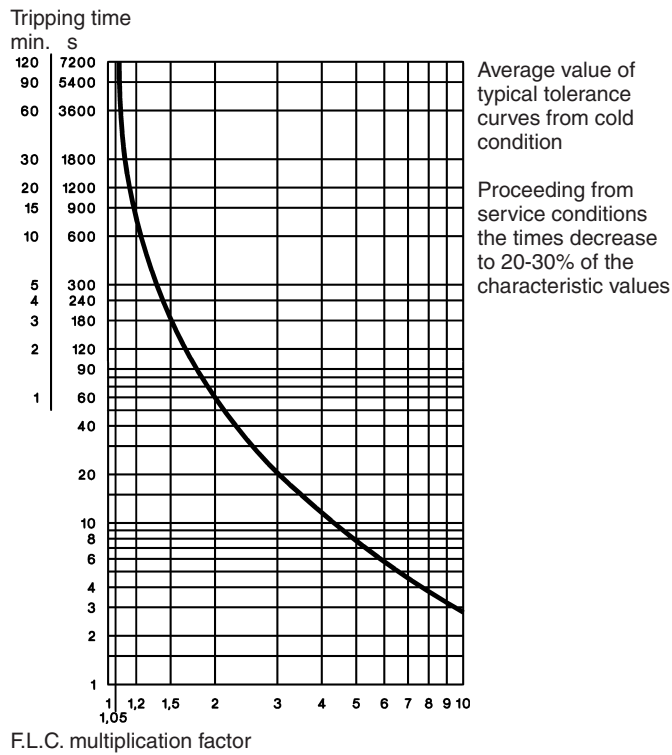

with two-pole load

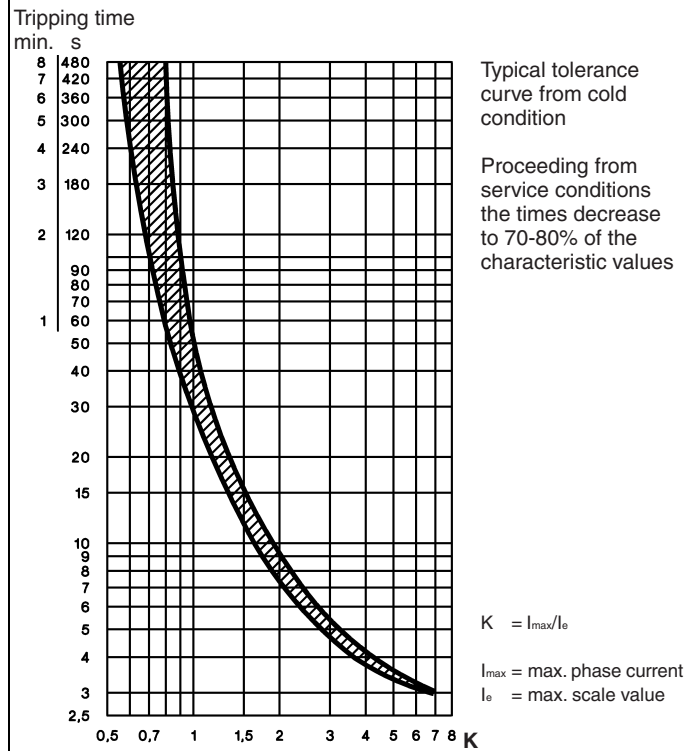

### Tripping Characteristics for J7TKN-E

Detailed tripping times for each range see table page 54

with three-phase load

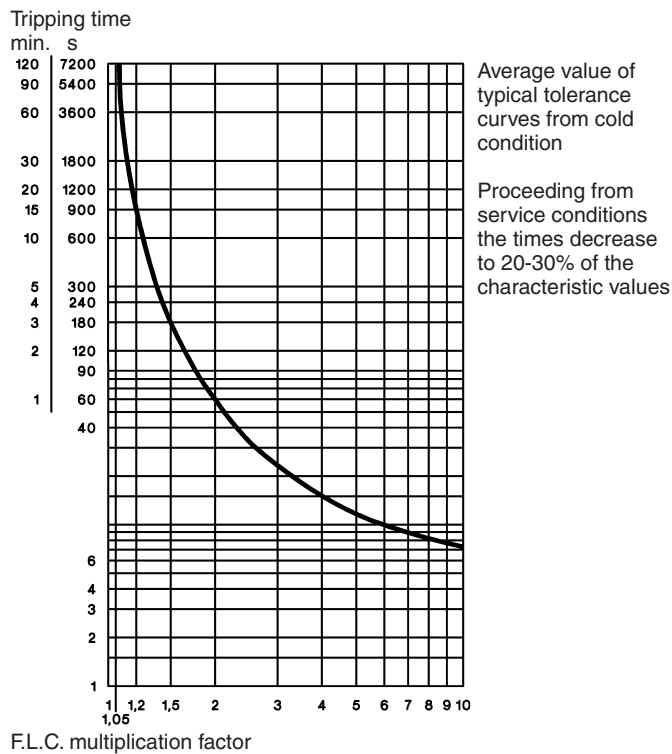

with two-pole load

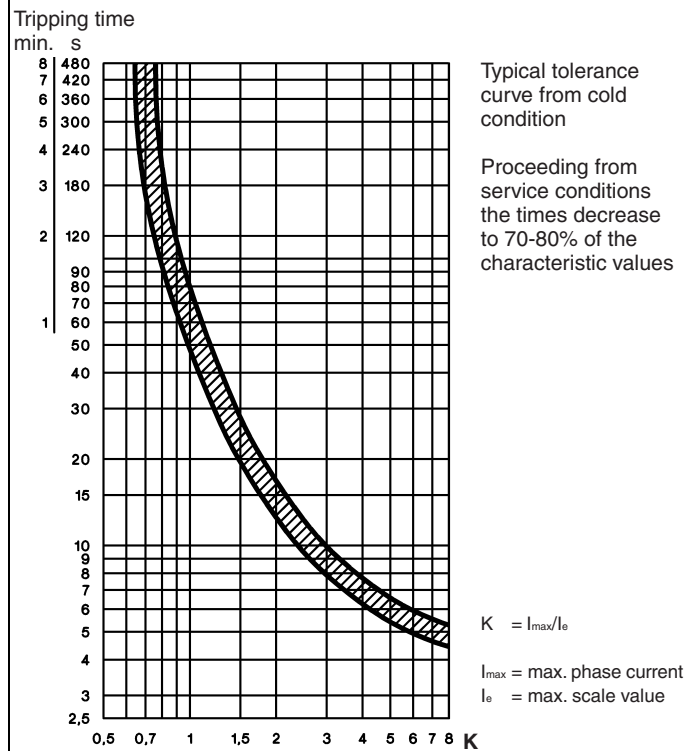

### Tripping Characteristics for J7TKN-F

Detailed tripping times for each range see table page 54

#### with three-phase load

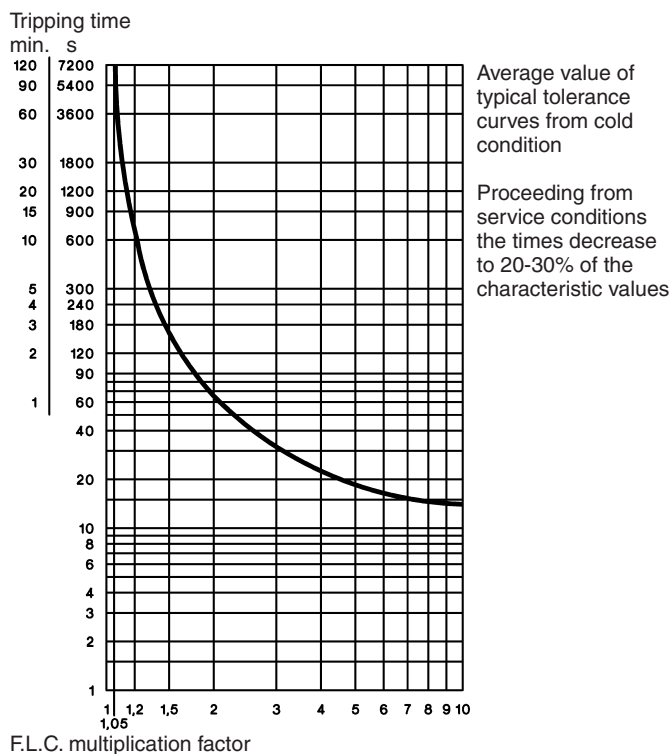

#### with two-pole load

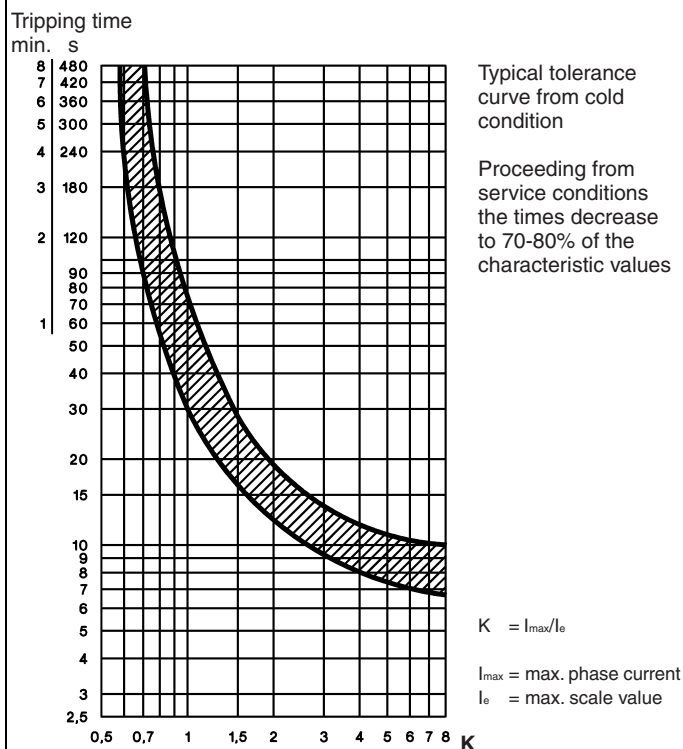

### Position of Terminals

J7TKN-A	J7TKN-B	J7TKN-C; J7TKN-D



## Thermal Overload Relays

Data according to IEC 947-4-1, IEC 947-5-1, VDE 0660, EN 60947-4-1, EN 60947-5-1

Type		J7TKN-A	J7TKN-B	J7TKN-C	J7TKN-D	J7TKN-E	J7TKN-F	
<b>Rated insulation voltage</b> $U_i^{*1}$	V~	690	690	690	690	750	690	
<b>Permissible ambient temperature</b>								
operation	open °C				-25 to +60			
storage	°C				-50 to +70			
<b>Trip class according to IEC 947-4-1</b>		10A	10A	10A	10A	20	20	
<b>Cable cross-section</b>								
main connector	solid or stranded	mm <sup>2</sup>	0.75-6 + 0.75-2.5 <sup>*2</sup>	0.75-6	0,75-10	4-35 <sup>*2</sup>	<sup>*3</sup>	<sup>*4</sup>
		flexible	mm <sup>2</sup>	0.75-4 + 0.5-2.5 <sup>*2</sup>	1-4	0,75-6	6-25 <sup>*2</sup>	
	flexible with multicore cable end	mm <sup>2</sup>	0.5-2.5 + 0.5-1.5	0.75-4	0.75-6	4-25		
Cables per clamp	number	1+1	2	2	1			
auxiliary connector	solid	mm <sup>2</sup>			0.75-2.5 <sup>*2</sup>			
	flexible	mm <sup>2</sup>			0.5-2.5 <sup>*2</sup>			
	flexible with multicore cable end	mm <sup>2</sup>			0.5-1.5			
Cables per clamp	number				2			
<b>Auxiliary contacts</b>								
<b>Rated insulation voltage</b> $U_i^{*1}$								
same potential	V~	690	690		690		690	
different potential	V~	440	440		250		440	
<b>Utilization category AC15</b>								
Rated operational current $I_e$	24V	A	5	3		4 <sup>*5</sup>	5	
	230V	A	3	2		2.5	3	
	400V	A	2	1		1.5	2	
	690V	A	0.6	0.5		0.6	0.6	
<b>Utilization category DC13</b>								
Rated operational current $I_e$	24V	A	1.2	1		1.2	1.2	
	110V	A	0.15	0.15		0.15	0.15	
	220V	A	0.1	0.1		0.1	0.1	
<b>Short circuit protection (without welding 1kA)</b>								
highest fuse rating	gL (gG)	A	6	4		6	6	
<b>Setting range</b>	A	to 23	all	28-42	52-65	all	-	
<b>Power loss per current path (max.)</b>								
minimum setting value	W	1.1	1.1	1.3	2.9	1.1	-	
maximum setting value	W	2.3	2.3	3.3	4.5	2.5	-	

\*1) Suitable for: earthed-neutral systems, overvoltage category I to III, pollution degree 3 (standard-industry:  $U_{imp} = 4kV$  (at 440V), 6kV (at 690V). Data for other conditions on request.

\*2) Maximum cable cross-section with prepared conductor

\*3) Without terminals, suitable for bushing one connector 70mm<sup>2</sup> (stranded) per phase

\*4) Busbar sets see accessories page 53

\*5) Switching capacity of the start contact: AC15 300VA, max. 1.5A, DC13 (max. 220V) 30W, max. 1.5A

**Data according to cULus**

Type		J7TKN-A	J7TKN-B	J7TKN-C	J7TKN-D	J7TKN-E
<b>Rated insulation voltage</b>	V~	600	600	600	600	600
<b>Rated current</b>	A	23	32	42	74	85
<b>Auxiliary contacts</b>						
Rated voltage						
same potential	V AC	600	600	600	600	600
different potential	V~	150	150	150	150	150
<b>Switching capacity AC</b>						
of aux. contacts	A	4	2	4	4	4

**Temperature Compensation**

In case of higher ambient temperature use the following formula:  
 (Ambient temperature - 20) x 0.125 = correction factor in % of the  
 full load motor current

Example:

Ambient temperature 70°C, full load motor current 7A

$(70 - 20) \times 0.125 = 6.25\%$

Setting value:  $7A + 6,25\% = 7.44A$

■ Dimensions

J7KNA-09 + J7TKN-A  
J7KNA-12

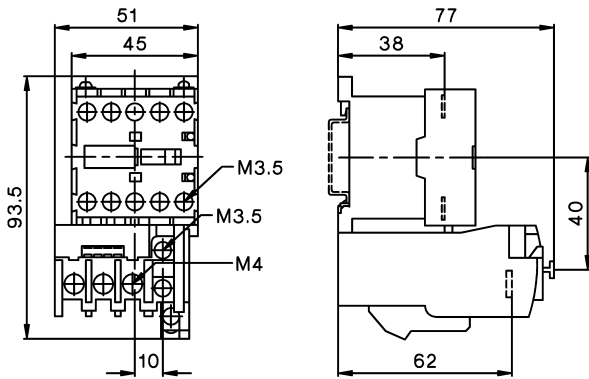

J7KN-10 + J7TKN-B  
J7KN-14  
J7KN-18  
J7KN-22

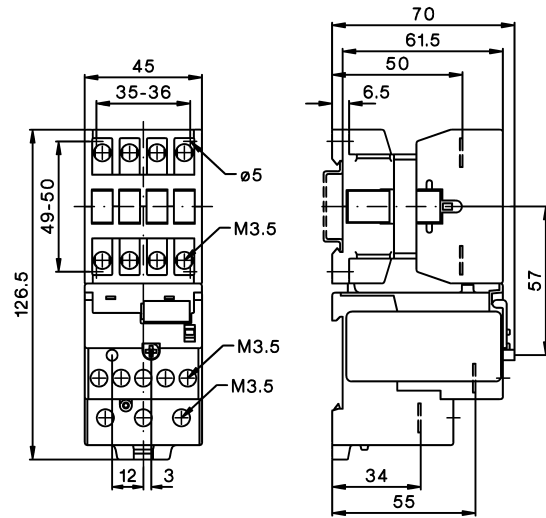

J7KN-10 + J7TKN-A  
J7KN-14  
J7KN-18  
J7KN-22

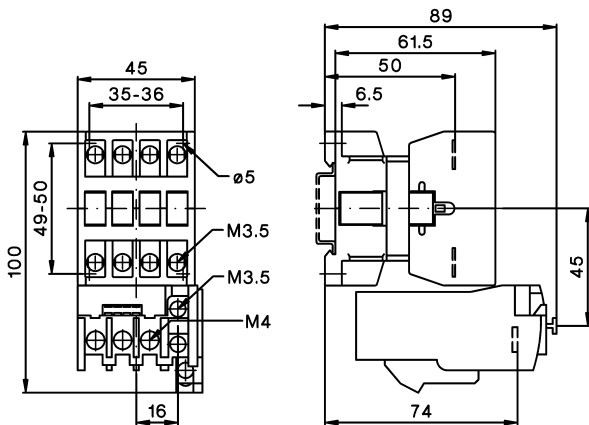

J7KN-24 + J7TKN-B  
J7KN-32  
J7KN-40

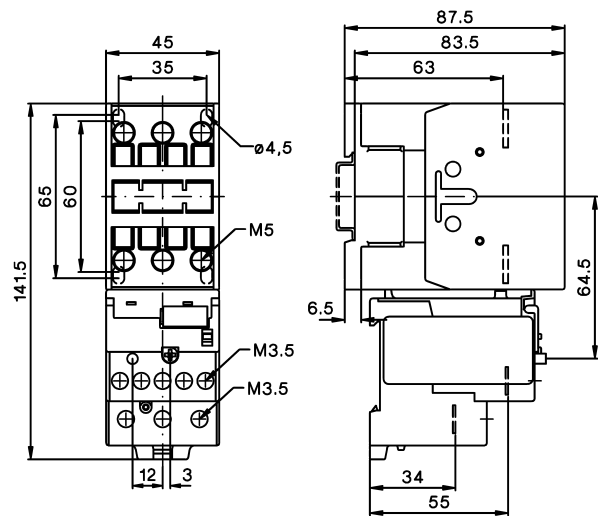

J7KN-24 + J7TKN-C  
J7KN-32  
J7KN-40

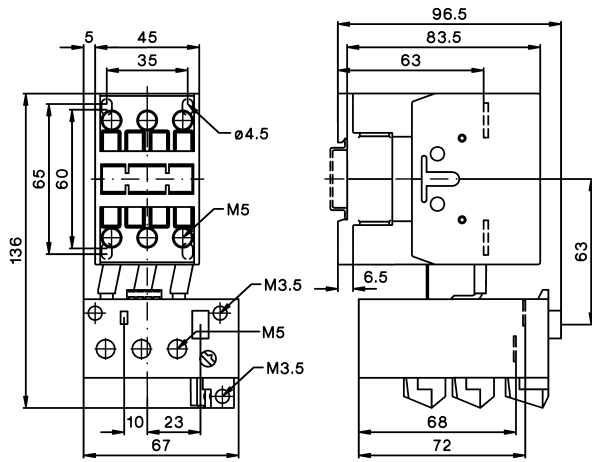

J7KN-50 + J7TKN-D  
J7KN-62  
J7KN-74

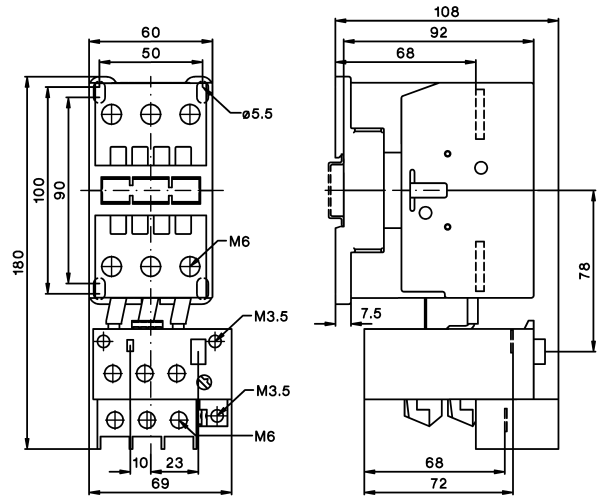

J7KN-85 + J7TKN-E  
J7KN-110

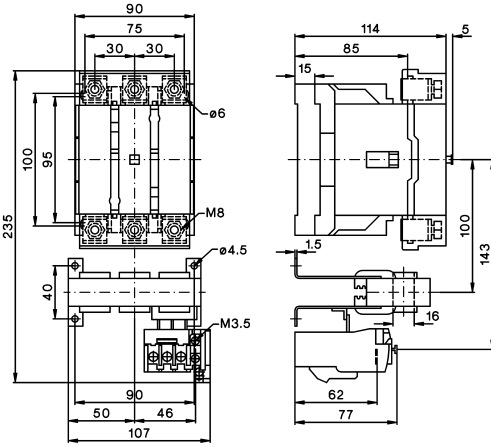

J7KN-150 + J7TKN-F  
J7KN-175

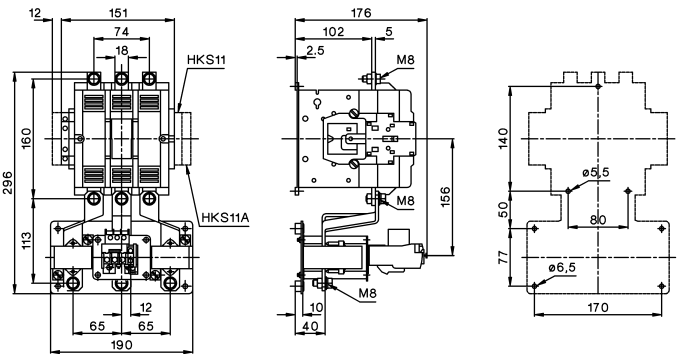

J7KN-200 + J7TKN-210

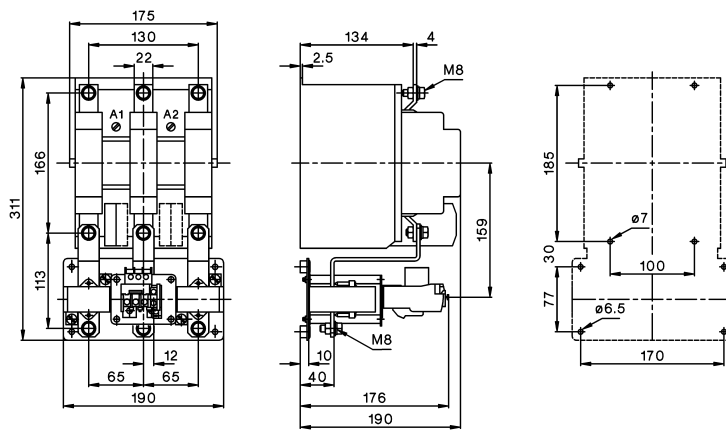

ALL DIMENSIONS SHOWN ARE IN MILLIMETERS.

To convert millimeters into inches, multiply by 0.03937. To convert grams into ounces, multiply by 0.03527.

Cat. No. J509-E2-01

In the interest of product improvement, specifications are subject to change without notice.



## Artisan Technology Group is your source for quality new and certified-used/pre-owned equipment

- FAST SHIPPING AND DELIVERY
- TENS OF THOUSANDS OF IN-STOCK ITEMS
- EQUIPMENT DEMOS
- HUNDREDS OF MANUFACTURERS SUPPORTED
- LEASING/MONTHLY RENTALS
- ITAR CERTIFIED SECURE ASSET SOLUTIONS

### SERVICE CENTER REPAIRS

Experienced engineers and technicians on staff at our full-service, in-house repair center

### *InstraView*<sup>SM</sup> REMOTE INSPECTION

Remotely inspect equipment before purchasing with our interactive website at [www.instraview.com](http://www.instraview.com) ↗

### WE BUY USED EQUIPMENT

Sell your excess, underutilized, and idle used equipment. We also offer credit for buy-backs and trade-ins. [www.artisanng.com/WeBuyEquipment](http://www.artisanng.com/WeBuyEquipment) ↗

### LOOKING FOR MORE INFORMATION?

Visit us on the web at [www.artisanng.com](http://www.artisanng.com) ↗ for more information on price quotations, drivers, technical specifications, manuals, and documentation

**Contact us:** (888) 88-SOURCE | [sales@artisanng.com](mailto:sales@artisanng.com) | [www.artisanng.com](http://www.artisanng.com)