



Artisan Scientific

QUALITY INSTRUMENTATION ... GUARANTEED

Looking for more information?

Visit us on the web at <http://www.artisan-scientific.com> for more information:

- Price Quotations
- Drivers
- Technical Specifications, Manuals and Documentation

Artisan Scientific is Your Source for Quality New and Certified-Used/Pre-owned Equipment

- Tens of Thousands of In-Stock Items
- Hundreds of Manufacturers Supported
- Fast Shipping and Delivery
- Leasing / Monthly Rentals
- Equipment Demos
- Consignment

Service Center Repairs

Experienced Engineers and Technicians on staff in our State-of-the-art Full-Service In-House Service Center Facility

InstraView™ Remote Inspection

Remotely inspect equipment before purchasing with our Innovative InstraView™ website at <http://www.instraview.com>

We buy used equipment! We also offer credit for Buy-Backs and Trade-Ins

Sell your excess, underutilized, and idle used equipment. Contact one of our Customer Service Representatives today!

Talk to a live person: 888-88-SOURCE (888-887-6872) | Contact us by email: sales@artisan-scientific.com | Visit our website: <http://www.artisan-scientific.com>

Pacific Scientific Model 6445 Indexer/Microstepping Drive Package



FEATURES

- ❖ Powered off-line 120 / 240 VAC 60 / 50 Hz
- ❖ Patented 4 phase bipolar chopper drive for superior current regulation and low ripple current.
- ❖ Output current adjustable from 0.625 A_{RMS} to 5 A_{RMS} with 3-position DIP switch.
- ❖ Patented Digital Electronic Damping™ reduces instability at mid-speed ranges
- ❖ Adjustable idle current reduction reduces motor heating in many applications.
- ❖ Power supply fault protection is provided for over temperature, short circuit, and under voltage.
- ❖ Drive fault protection is provided for line to line, line to neutral, and microprocessor faults.
- ❖ 66 VDC output supply to power additional axis
- ❖ Internal cooling fan
- ❖ Microstepping up to 51,200 steps per revolution
- ❖ Master / slave, two axis control
- ❖ Easy programming using Danaher Motion's Stepper BASIC™
- ❖ Dedicated and user configurable I/O
- ❖ Encoder interface for position verification
- ❖ Single and multi-drop serial communication
- ❖ 16 user configurable inputs
- ❖ 12 user configurable outputs
- ❖ UL and CSA recognition pending
- ❖ CE conformance pending

APPLICATIONS

- ❖ Clutch brake replacement
- ❖ Master / slave shaft following
- ❖ Labeling machines
- ❖ Feed to length
- ❖ Menu prompt (MMI)

PRODUCT DESCRIPTION

Danaher Motion's Pacific Scientific 6445 is an economical, high performance microstepping drive combined with a programmable indexer. The package uses an RS-232/485 port to allow single or multi-axis communication at 9600 baud. 16 programmable inputs and 12 programmable outputs are compatible with standard 5 to 30 VDC I/O. The 6445 features 12 k of battery-backed RAM for storage of parameters and move profiles. Motion control programming is simplified with Danaher Motion's Stepper BASIC™, an easy to learn extension of the BASIC™ protocol.

Resolution with 1.8° motors ranges from 200 to 51,200 steps-per-revolution. Step sizes are in decimal increments. Higher resolution (microstepping) provides smoother operation through low speed resonance regions. A patented Digital Electronic Damping™ circuit ensures the availability of full motor torque at all speed ranges by damping motor oscillations common with stepper systems. Full motor torque is achieved throughout the speed range whether in the full step or microstepping mode.

Adjustable idle current reduction permits an automatic 50% reduction in motor winding current during motor idle conditions to minimize heating during dwell periods. If no step commands have been received for 0.1 seconds the current is automatically reduced. Current is restored to full amplitude upon the arrival of a step command.

The 6445 accepts quadrature encoder inputs to perform position verification and correction, stall detection, and electronic gearing functions. A quadrature encoder with line driven outputs is required.

A 66 VDC output voltage is provided to power an additional axis.

SPECIFICATIONS

INPUT POWER

| | |
|--|--|
| Voltage | 120/240 VAC (+10%, -15%) 60-50 Hz (switch selectable) |
| Line Current At Full Load (300 W) | 240 VAC - 3.7 A _{RMS} , 120 VAC - 4.7 A _{RMS} |
| Output Motor Phase Current | 5 A _{RMS} max., 5 A _{PEAK} full step (square wave) 7.1 A _{PEAK} microstepping (sine wave) Adjustable from 0.625 A _{RMS} to 5 A _{RMS} in 0.625 A _{RMS} increments |
| 66 VDC Output for 2nd Axis | 66 ±3 V. Total power (internal + external) = 300 W ±10% |
| Discrete Inputs | 5 VDC pull up. See <i>Connection Diagram</i> for discrete wiring. |
| Discrete Outputs | 50 mA sink max. at 0.5 VDC, VCE 40 VDC max. See <i>Connection Diagram</i> for discrete wiring. |

ENVIRONMENTAL

| | |
|------------------------------|---|
| Storage Temperature | -40° C to + 70° C |
| Operating Temperature | 0° C to 50° C ambient (with internal fan) |
| Altitude | 5000 ft (1500 m) by design |
| Humidity | 10% to 90%, non-condensing by design |
| Vibration | IEC Standard 68-2-6 pending |

MECHANICAL

| | |
|-------------------|------------------------------|
| Dimensions | 6.30 in x 4.25 in x 12.50 in |
| Weight | 10 lbs. nominal |

CONNECTORS

| | |
|---|---|
| 66 VDC output | PCD ELVHØ31Ø Mating connector PCD ELVPØ31ØØ |
| Motor | PCD ELVHØ51Ø Mating connector PCD ELVPØ51ØØ |
| AC Input | PCD ELFH Ø311Ø Mating connector PCD ELFPØ311Ø |
| Serial | 9 contact female D connector. Mating connector ITT Cannon DE-9P with ITT Cannon DE110963 Hood and D20419 clamp kit. |
| I/O | Double height 17 position, pluggable screw terminal Phoenix connector MSTB2, 5/17-ST(x2) |
| Encoder input and Step/Direction | Double height 9 position, pluggable screw terminal Phoenix connector MSTB2, 5/9-ST(x2) |

CONNECTION DIAGRAM

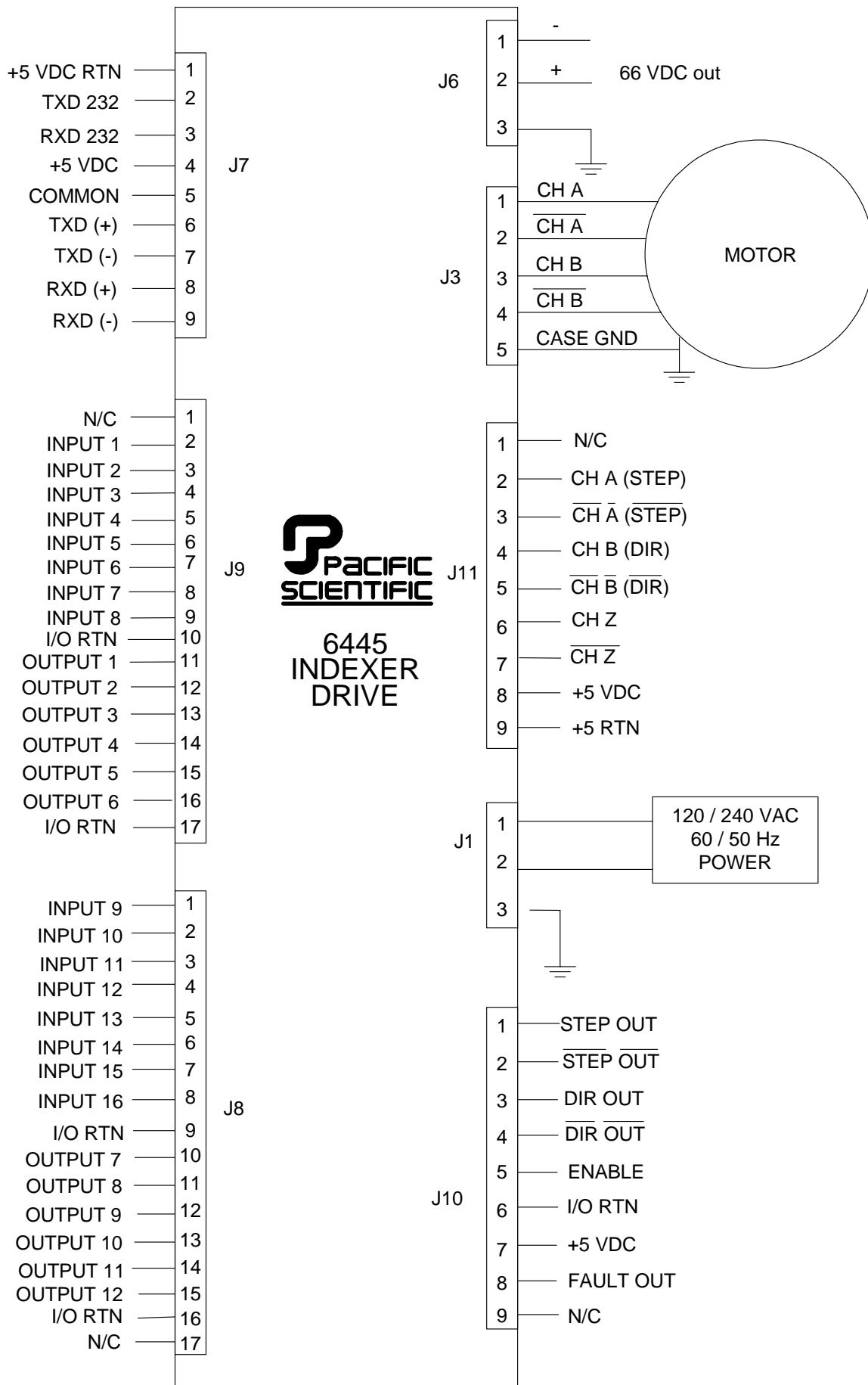

OUTPUT DIFFERENTIAL WIRING

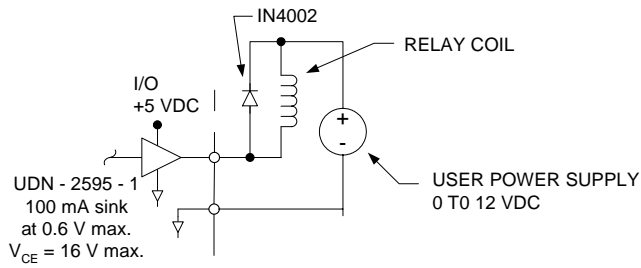

RELAY LOAD

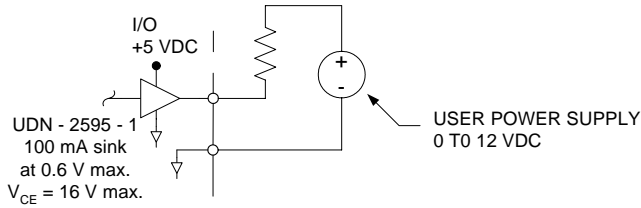

RESISTIVE LOAD

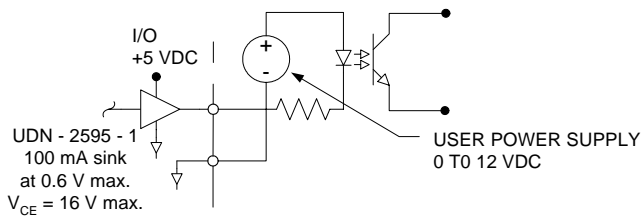

OPTO-ISOLATOR LOAD

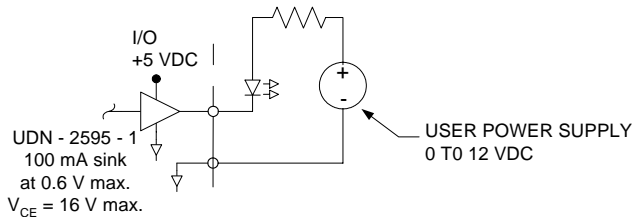

LED INDICATOR LOAD

DISCRETE INPUT CONFIGURATION

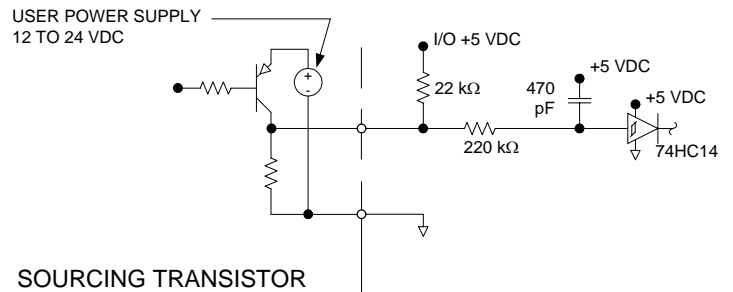
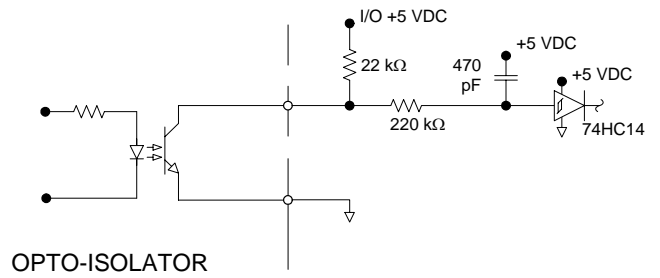
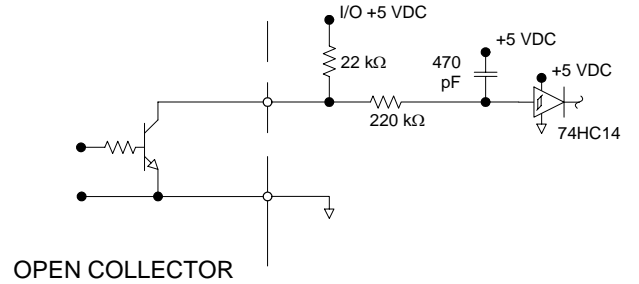
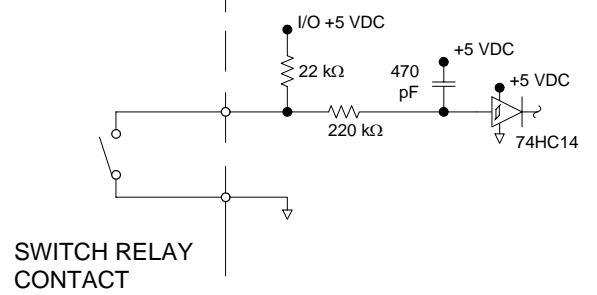

DIP SWITCH (S1) SETTINGS

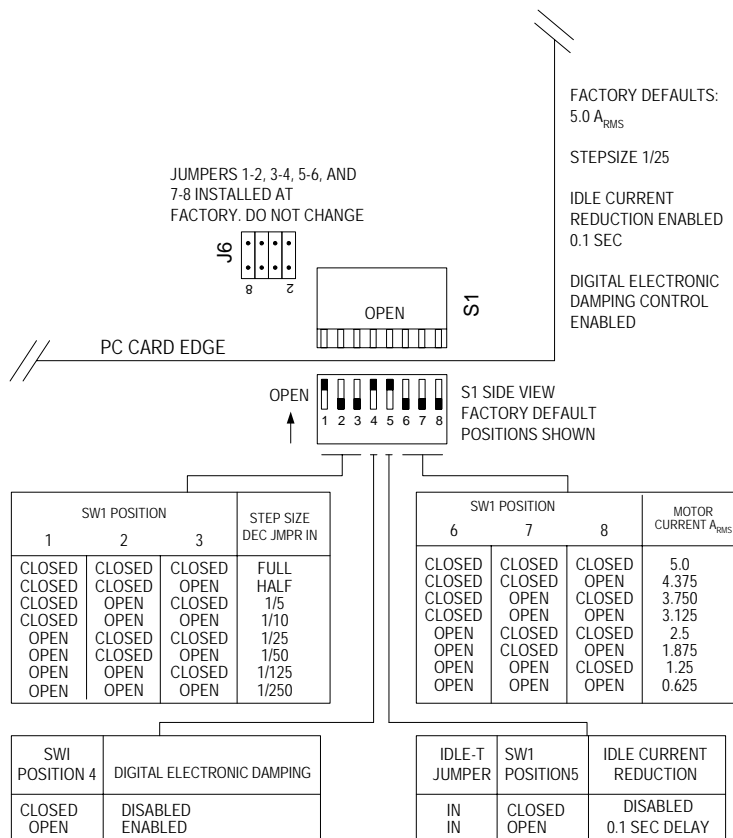

SERIAL ADDRESSES

| Address | 1 | 2 | 3 | 4 | 5 |
|---------|-----|-----|-----|-----|-----|
| 0 | On | On | On | On | On |
| 1 | Off | On | On | On | On |
| 2 | On | Off | On | On | On |
| 3 | Off | Off | On | On | On |
| 4 | On | On | Off | On | On |
| 5 | Off | On | Off | On | On |
| 6 | On | Off | Off | On | On |
| 7 | Off | Off | Off | On | On |
| 8 | On | On | On | Off | On |
| 9 | Off | On | On | Off | On |
| 10 | On | Off | On | Off | On |
| 11 | Off | Off | On | Off | On |
| 12 | On | On | Off | Off | On |
| 13 | Off | On | Off | Off | On |
| 14 | On | Off | Off | Off | On |
| 15 | Off | Off | Off | Off | On |
| 16 | On | On | On | On | Off |
| 17 | Off | On | On | On | Off |
| 18 | On | Off | On | On | Off |
| 19 | Off | Off | On | On | Off |
| 20 | On | On | Off | On | Off |
| 21 | Off | On | Off | On | Off |
| 22 | On | Off | Off | On | Off |
| 23 | Off | Off | Off | On | Off |
| 24 | On | On | On | Off | Off |
| 25 | Off | On | On | Off | Off |
| 26 | On | Off | On | Off | Off |
| 27 | Off | Off | On | Off | Off |
| 28 | On | On | Off | Off | Off |
| 29 | Off | On | Off | Off | Off |
| 30 | On | Off | Off | Off | Off |
| 31 | Off | Off | Off | Off | Off |



Switch settings must be made when the unit is unpowered.



Address 31 is for RS-232 operation, all others are for RS-422/485. RS-232 operation is the factory default setting.

S2 SWITCH SETTINGS

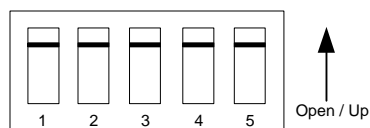

On = Closed / Down Position
Off = Open / Up Position



Switches S1 and S2 are easily accessed without removing the cover.

MOUNTING DIMENSIONS

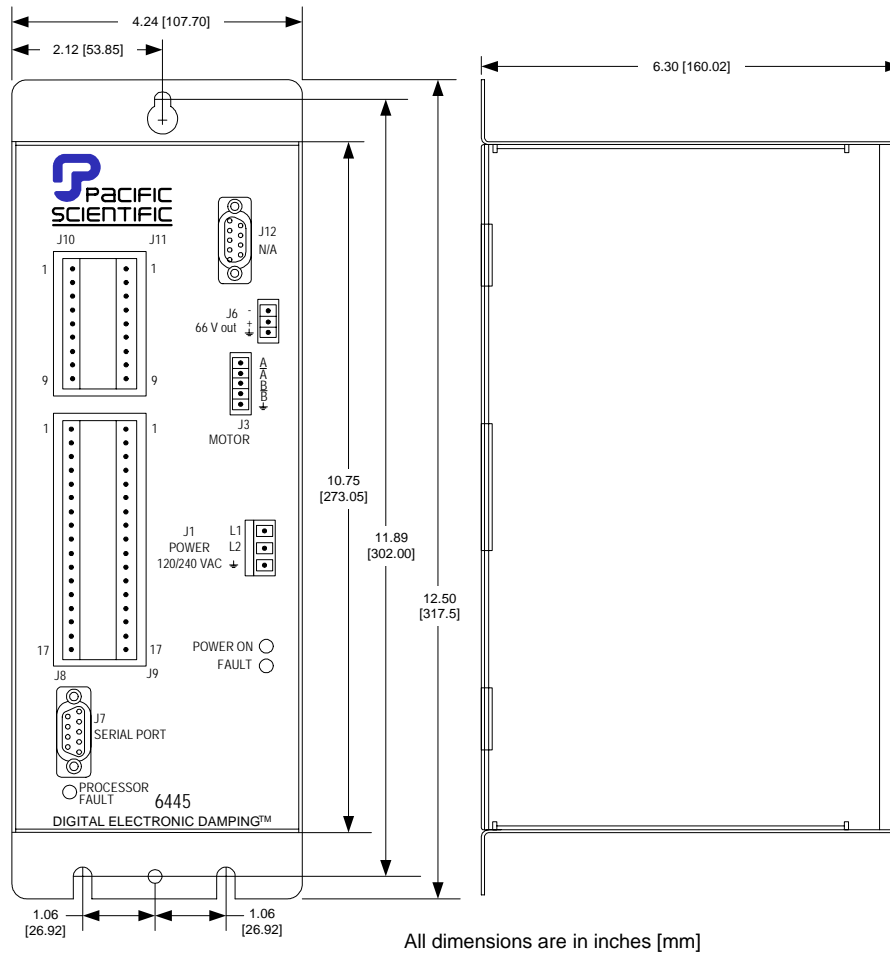

AC SWITCH SETTINGS

The AC switch is accessible by opening the cover and is preset at the factory to the 230 VAC position. First, make certain the power connections have been removed and rest the unit on its side as shown. Unscrew four screws and two jack screws as shown to remove cover. *Cautiously remove cover, being careful not to put a strain on the ribbon cable or power supply cable.* Select appropriate setting. **DO NOT** over tighten the mounting screws. (5.0 in-lbs max.)



Connecting 240 (230) VAC with the switch in 120 (115) VAC position will permanently damage the drive.

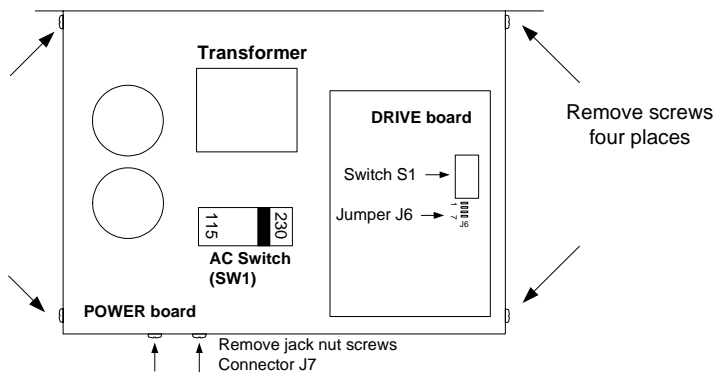

66 VDC OUTPUT CONNECTOR J6

The 6445 package has a connector J6, 66 VDC, designed to power an additional drive. The total power available for both the internal and external drives is 66 VDC at 4.6 A or approximately 300 W. If the two drives are running simultaneously and require more than 4.6 A, the voltage will begin to cut back. The power supply has a low voltage protection circuit that will fault the drive if the voltage is less than 55 VDC.

A twisted pair plus grounding cable using 16, 18, or 20 gauge wire is recommended to connect the remote connector to the external drive. An aluminum electrolytic capacitor (maximum 1000 μ F, 100 VDC) rated for 2 A ripple current or greater must be installed at the additional drive if the cable length is over 3 feet.

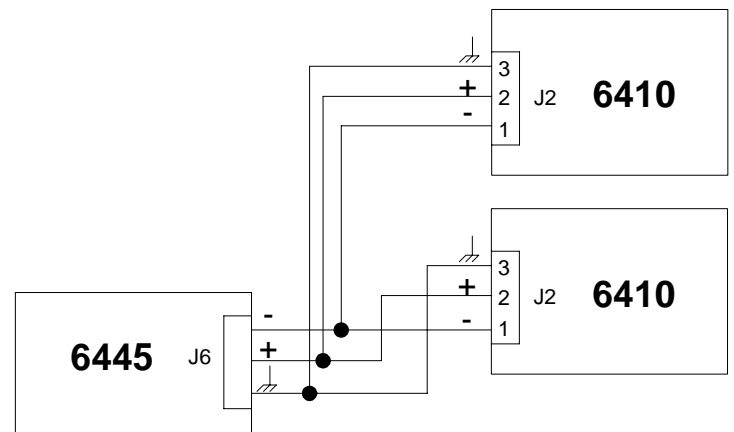

TROUBLESHOOTING

Fault LED on – 6445 Disable Fault

| Symptom | Possible Cause | Corrective Action |
|--|--|---|
| Motor does not turn. LEDs on (green and/or red) | 120 / 240 VAC switch in 240 position with input from 120 VAC | Turn power off, correct switch position |
| | AC input line low. | Increase input AC to spec. |
| | Dead short or overload across external 66 VDC output connector J6 | Remove short or reduce load. |
| | Over Temperature | Check ambient temperature or internal fan malfunction/blockage. |
| | Bad load connection | Check load connection Check J6 VDC output with a voltmeter and ensure voltage is 66 V \pm 3 V. 1. If voltage output > 70 VDC and < 78 VDC add a load and ensure VDC is approximately 66 VDC 2. If output voltage > 78 VDC, return the 6445 to factory for service. |
| | Internal Failure | Return to factory for service. |
| Motor does not turn, LEDs off. | Check AC input | Use proper input. |
| | 240 VAC applied and switch in 120 VAC position | Return to factory for service |
| Motor runs for a while and stops. Both LEDs come on | Over Temperature | Reduce load. Check for excessive ambient temperature. Check for internal fan malfunction / blockage. |
| Motor turns on and off on its own (although no such commands are given) and red LED keeps flashing | 120 VAC applied and switch in 240 VAC position | Turn power off, correct switch position |
| | Over load | Reduce load |
| | AC input line low | Check input AC line voltage for low line. |
| Red LED turns on when motor tries to accelerate, motor does not turn. | Load is too high, AND/OR accel/decel is too high AND/OR run speed is too high. | Reduce the load, accel/decel, and/or run speed. |

Red LED Flashing With No Fault



If the power supply is on the verge of an under-voltage fault, you will notice the following during normal operation.

| Symptom | Possible Cause | Corrective Action |
|----------------------------------|--|---|
| Motor runs fine, red LED flashes | Load is too high, AND/OR accel/decel is too high AND/OR run speed is too high. | Although no action is required, the symptom may be reduced by reducing the load, accel/decel, and/or run speed. |

Processor Fault LED On

| Symptom | Possible Cause | Corrective Action |
|--|---|---|
| Drive faults when enabled | Motor output over-current | Disconnect the AC power. Disconnect motor cable and cycle the J1 120/240 VAC 60-50 Hz power off and on. If the processor fault LED is off, check motor cable and shorts across the windings or between the windings and the motor case. |
| Drive faults while decelerating | Drive internal bus over voltage | Measure drive internal bus voltage at J6-1 and J6-2 (66 VDC out) with a storage oscilloscope during deceleration. If regeneration causes the bus voltage to exceed 84 V, verify the total load inertia to insure that the 66 VDC out limit is never exceeded. |
| Processor Fault LED on when power is applied | Indexer external +5 V logic supply out of tolerance | Measure the +5 V logic supply from J7-4 to J7-1 and J10-7 to J10-6 within +5 V (\pm 5%). The total 5 VDC current from pins J7-4, J11-8, and J10-7 must be less than 450 mA. |
| | Indexer processor watchdog timer failed | Internal failure. Return to factory for service. |

Communication Interface Fault

| Symptom | Corrective Action |
|---|---|
| 6445 will not respond to commands over serial link | Verify that baud rate and COM port are set correctly in PacCom |
| | Check that terminal transmit and receive lines from the computer go to receive and transmit lines on the 6445 |
| | Verify that the serial cable is functioning properly <ol style="list-style-type: none"> 1. Disconnect serial cable 2. Short pins 2 and 3 3. Type a character on the keyboard 4. Verify that character entered echoes back to screen |
| | Verify that the serial cable is connected to J7. <i>J12 is not used on the 6445</i> |
| | Internal Failure. Return to factory for service |
| 6445 will not respond during RS-422/ RS-485 operation | Verify that each unit has a unique serial address using switch S2 |

PERFORMANCE

Motors will perform as shown without the winding temperature exceeding a rise of 90° C when the motor is operated unmounted (without a heatsink) in an ambient temperature of up to 40° C. The curves do not reflect system resonance points, which will vary with motor coupling and system parameters.

In addition to those shown, Danaher Motion offers a wide range of other motor windings to meet specific performance requirements.

RECOMMENDED MOTORS FOR 5.0 A OPERATION

3 in. Motor - One Rotor Stack
E31NX-HTLNN-NS50
5.0 A / 65 V per phase

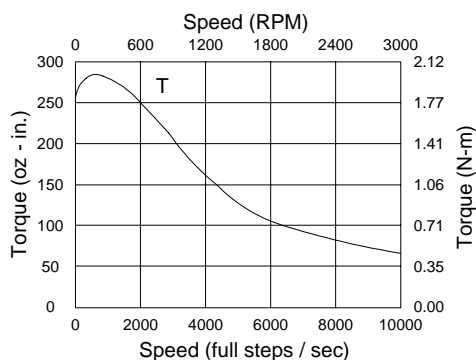

3 in. Motor - Two Rotor Stacks
E32NX-HTLNN-NS50
E32NX-HPLNN-NS50
5.0 A / 65 V per phase

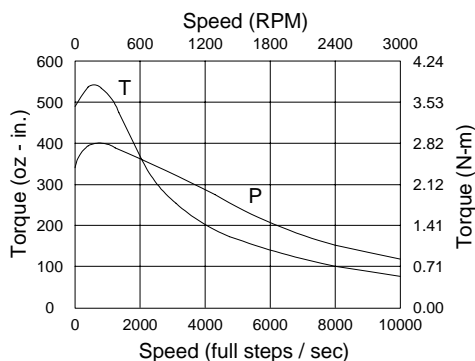

3 in. Motor - Three Rotor Stacks
E33NX-HTLNN-NS50
E33NX-HPLNN-NS50
5.0 A / 65 V per phase

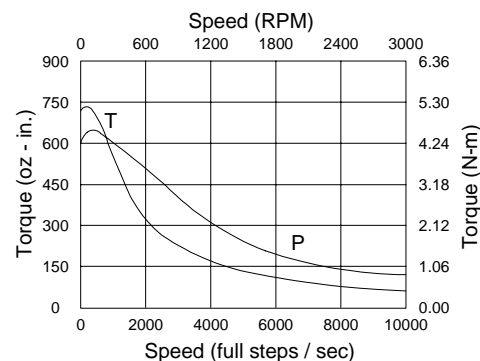

3 in. Motor - Four Rotor Stacks
E34HX-HTLNN-NS50
E32HX-HPLNN-NS50
5.0 A / 65 V per phase

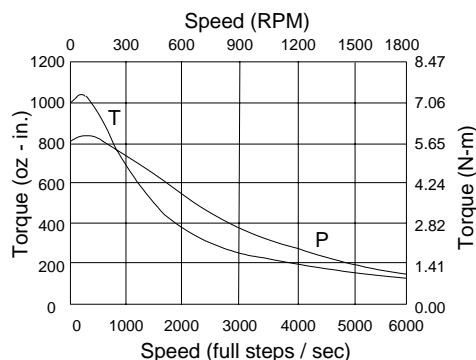

4 in. Motor - One Rotor Stack
E41HX-HTLNN-NS50
5.0 A / 65 V per phase

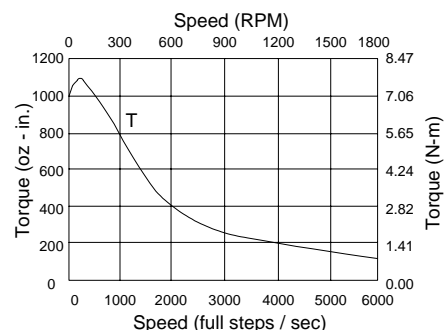

RECOMMENDED MOTORS FOR 2.5 A OPERATION

3 in. Motor - One Rotor Stack

E31NX-LTLNN-NS50

E31NX-LPLNN-NS50

2.5 A / 65 V per phase

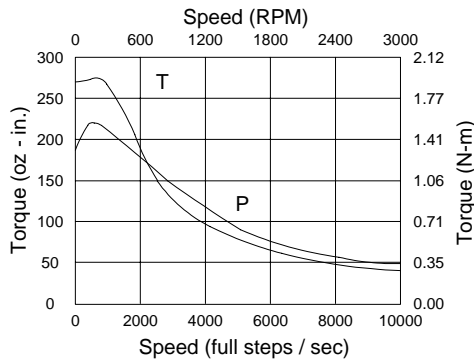

3 in. Motor - Two Rotor Stacks

E32NX-LTLNN-NS50

E32NX-LPLNN-NS50

2.5 A / 65 V per phase

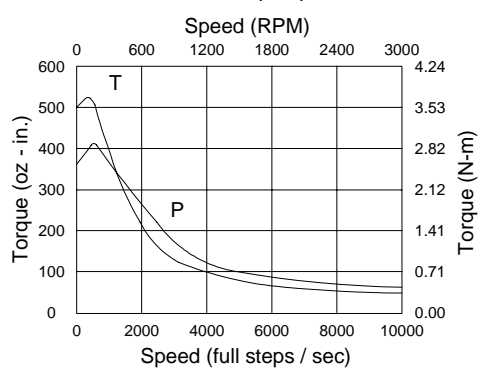

2 in. Motor - Two Rotor Stacks

E22NX-LTLNN-NS50

E22NX-LPLNN-NS50

2.5 A / 65 V per phase

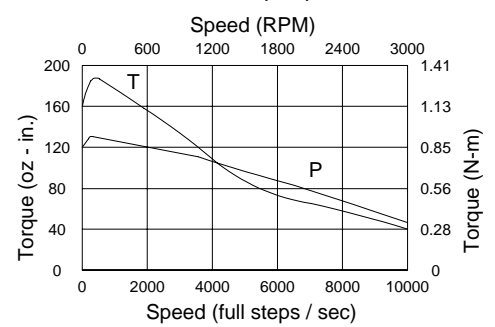

CUSTOMER SUPPORT

Danaher Motion products are available world-wide through an extensive authorized distributor network. These distributors offer literature, technical assistance, and a wide range of models off the shelf for the fastest possible delivery.

Danaher Motion sales engineers are conveniently located to provide prompt attention to customer needs. Call the nearest office for ordering and application information and assistance or for the address of the closest authorized distributor. If you do not know who your sales representative is, contact us at:

Danaher Motion

203A West Rock Road

Radford, VA 24141 USA

Phone: 1-540-633-3400

Fax: 1-540-639-4162

Email: customer.support@danahermotion.com

Website: www.DanaherMotion.com



Artisan Scientific

QUALITY INSTRUMENTATION ... GUARANTEED

Looking for more information?

Visit us on the web at <http://www.artisan-scientific.com> for more information:

- Price Quotations
- Drivers
- Technical Specifications, Manuals and Documentation

Artisan Scientific is Your Source for Quality New and Certified-Used/Pre-owned Equipment

- Tens of Thousands of In-Stock Items
- Hundreds of Manufacturers Supported
- Fast Shipping and Delivery
- Leasing / Monthly Rentals
- Equipment Demos
- Consignment

Service Center Repairs

Experienced Engineers and Technicians on staff in our State-of-the-art Full-Service In-House Service Center Facility

InstraView™ Remote Inspection

Remotely inspect equipment before purchasing with our Innovative InstraView™ website at <http://www.instraview.com>

We buy used equipment! We also offer credit for Buy-Backs and Trade-Ins

Sell your excess, underutilized, and idle used equipment. Contact one of our Customer Service Representatives today!

Talk to a live person: 888-88-SOURCE (888-887-6872) | Contact us by email: sales@artisan-scientific.com | Visit our website: <http://www.artisan-scientific.com>