



Artisan Technology Group is your source for quality new and certified-used/pre-owned equipment

- FAST SHIPPING AND DELIVERY
- TENS OF THOUSANDS OF IN-STOCK ITEMS
- EQUIPMENT DEMOS
- HUNDREDS OF MANUFACTURERS SUPPORTED
- LEASING/MONTHLY RENTALS
- ITAR CERTIFIED SECURE ASSET SOLUTIONS

SERVICE CENTER REPAIRS

Experienced engineers and technicians on staff at our full-service, in-house repair center

*InstraView*SM REMOTE INSPECTION

Remotely inspect equipment before purchasing with our interactive website at www.instraview.com ↗

WE BUY USED EQUIPMENT

Sell your excess, underutilized, and idle used equipment. We also offer credit for buy-backs and trade-ins. www.artisanng.com/WeBuyEquipment ↗

LOOKING FOR MORE INFORMATION?

Visit us on the web at www.artisanng.com ↗ for more information on price quotations, drivers, technical specifications, manuals, and documentation

Contact us: (888) 88-SOURCE | sales@artisanng.com | www.artisanng.com

Compumotor



**BD150E/230V and BD75E/230V
Brushless Servo Drives
User Guide**

1600.208.03 – August, 1996

Compumotor Division
Parker Hannifin Corporation
p/n 88-016696-01A November 1997



IMPORTANT INFORMATION FOR USERS

Installation and Operation of Digiplan Equipment

It is important that Digiplan motion control equipment is installed and operated in such a way that all applicable safety requirements are met. It is your responsibility as an installer to ensure that you identify the relevant safety standards and comply with them; failure to do so may result in damage to equipment and personal injury. In particular, you should study the contents of this user guide carefully before installing or operating the equipment.

Under no circumstances will the suppliers of the equipment be liable for any incidental, consequential or special damages of any kind whatsoever, including but not limited to lost profits arising from or in any way connected with the use of the equipment or this user guide.



SAFETY WARNING

High-performance motion control equipment is capable of producing rapid movement and very high forces. Unexpected motion may occur especially during the development of controller programs. **KEEP WELL CLEAR** of any machinery driven by stepper or servo motors. Never touch it while it is in operation.

This product is sold as a motion control component to be installed in a complete system using good engineering practice. Care must be taken to ensure that the product is installed and used in a safe manner according to local safety laws and regulations.

A permanent mains safety earth connection must be made to the earth terminal on the front of the drive case before applying mains power.

If the equipment is used in any manner that does not conform to the instructions given in this manual, then the protection provided by the equipment may be impaired.

EMC INFORMATION

EMC Information is presented in boxed paragraphs (such as this one). Digiplan cannot guarantee compliance unless guidelines are strictly followed.

The information in this user guide, including any apparatus, methods, techniques, and concepts described herein, are the proprietary property of Parker Digiplan or its licensors, and may not be copied, disclosed, or used for any purpose not expressly authorised by the owner thereof.

Since Digiplan constantly strives to improve all of its products, we reserve the right to modify equipment and user guides without prior notice. No part of this user guide may be reproduced in any form without the prior consent of Digiplan.

© *Digiplan Division of Parker Hannifin plc, 1996*
– *All Rights Reserved* –

The following Warning and Caution labels are fitted to the drive:

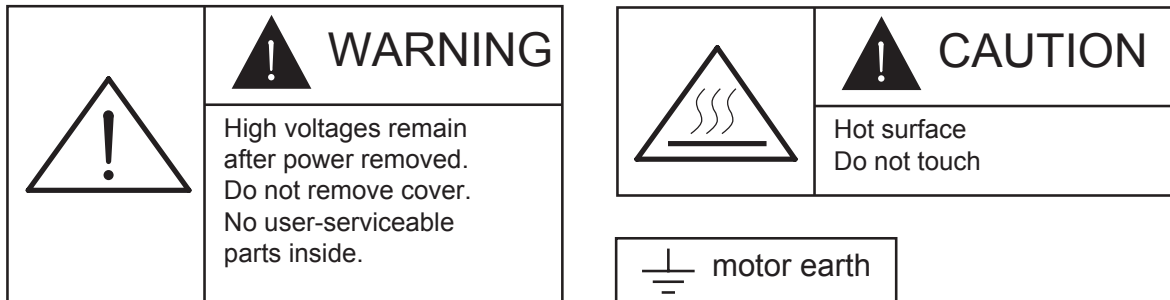

Symbols used on the BD-E series of drives have the following meanings:



Refer to the accompanying documentation



Protective conductor terminal



Risk of electric shock



Alternating current



Hot surface



Frame or chassis terminal



Product Type: BD150E/230V, BD75E/230V

The above product is in compliance with the requirements of directives

- **89/336/EEC** Electromagnetic Compatibility Directive
as amended by Directive 92/31/EEC

The product is intended for use in the Commercial, Light Industrial and Industrial Environments as defined in the relevant EMC standards.

This product is compliant with the Low Voltage Directive.

- **73/23/EEC** Low Voltage Directive
- **93/68/EEC** CE Marking Directive

CONTENTS

Section 1. INTRODUCTION..... 1
Section 2. GETTING STARTED 5
Section 3. INSTALLATION..... 9
Section 4. HARDWARE REFERENCE.....27
Section 5. MAINTENANCE & TROUBLESHOOTING31
Appendix A. ENCODER SETUP.....35
Index.....41

User Guide Change Summary

The following is a summary of the primary changes to this user guide since the last version was released.

When a user guide is updated, the new or changed text is differentiated with a change bar in the outside margin (this paragraph is an example). If an entire chapter is changed, the change bar is located on the outside margin of the chapter title.

Major changes introduced at revision 03 are:

- LVD Compliance

Section 1. INTRODUCTION

Product Description

The BD-E Series of EMC and LVD compliant brushless velocity/torque drives are capable of operating direct-on-line from a 220-240V AC input, with no isolating transformer. A choice of two current ratings are available:

BD150E/230V	6A RMS continuous (12A RMS peak)
BD75E/230V	3A RMS continuous (6A RMS peak)

Both drive types have high resolution sinusoidal commutation and have been designed to be used with three phase brushless servo motors. Control of either velocity or torque is provided via a $\pm 10V$ analogue input.

The drives are equipped with multiple protection circuits which guard against output short circuits and excessive current output over long time periods or at low speed operation. Further circuits protect against overspeed operation, commutation loss, motor feedback loss, overvoltage, undervoltage, supply failure and overtemperature faults.

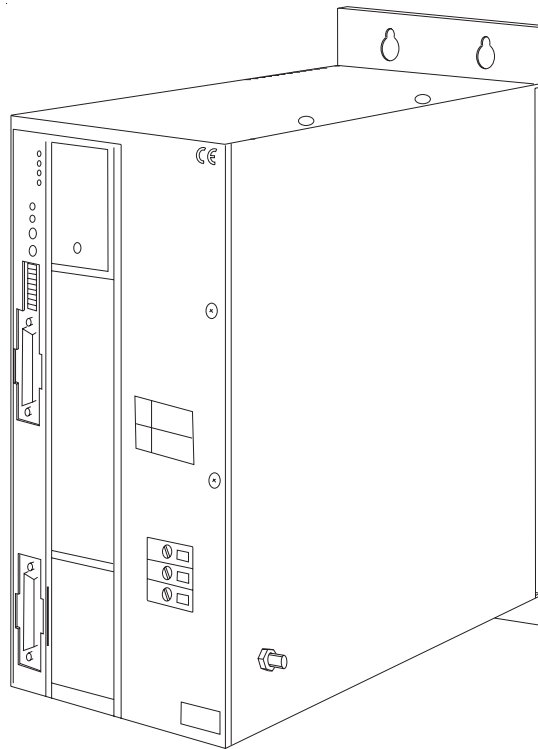

Figure 1-1. BD-E Drive

Current Limit LED (Yellow)

Illumination of this LED indicates that the current demand is exceeding the drives maximum programmed current, and is therefore clamped. For adjustment of the current limit level, see the current limit bit-switch setting sub-section.

IT Clamp LED (yellow)

The illumination of this LED indicates that the drive has been set to demand too much peak current for too long a time, causing the current limit to be reduced to 6.8A RMS for the BD150E/230V (3.4A RMS for the BD75E/230V) to protect the drive.

Overtemperature LED (Red)

Illumination of this LED indicates that either the drive or motor is operating outside its specified continuous temperature rating, requiring extra cooling to be used or reduction of the operating duty cycle.

Note: the over temperature LED will also be illuminated by faulty motor feedback connections. For more information refer to the Maintenance and Troubleshooting Section.

Drive Fault LED (Red)

This LED indicates one of the following fault conditions:

- Overvoltage
- Undervoltage
- Supply failure
- Overcurrent
- Overspeed

For more information refer to the Maintenance and Troubleshooting Section.

HV Present

This LED indicates that a voltage is present on the High Voltage capacitors.

Internal Commutation LEDs

Three diagnostic/set-up LEDs are present within the drive, but can be observed through the ventilation slots on top of the drive towards the front panel face. From the front panel face the LEDs are:

Red	Overcurrent
Yellow	Index
Yellow	Commutation

4 BD SERVO DRIVES USER GUIDE

The index LED is illuminated when the index pulse is high and the commutation LED lights when the A channel of the commutation encoder (Com A+) is high. For more information refer to the Commutation sub-section. The red overcurrent LED provides greater diagnostic information under drive fault conditions.

Potentiometers

Balance

This 20 turn potentiometer is used to adjust the balance of the amplifier to give zero motor current when there is no velocity input demand.

Tach Gain

The level of the velocity feedback is adjusted by this 20 turn potentiometer. For settings see the Installation section.

Time Constant

The Time Constant single turn potentiometer and associated components determine the bandwidth of the amplifier. For settings see the Installation section.

Damping

This single turn potentiometer adjusts the response characteristic of the amplifier so that the axis achieves the demanded velocity without overshoot. For settings see the Installation section.

Bit Switch

All drive options are selected by the front panel bit switch, there are no internal links or adjustments within the drive.

The bit switch selects the following functions:

Bit Switch Number	Function
1, 2	Motor pole number
3	Commutation encoder pull-up selection
4	Encoder resolution
5	Velocity/Torque selection
6	Reset pull-up/pull-down
7, 8	Current limit

Table 1-1. Bit Switch Setting

Section 2. GETTING STARTED

What You Should Have

Upon receipt, you should inspect your BD-E Series Drive system for obvious damage to its container. Report any damage as soon as possible. The items listed in Table 2-1 should be present and in good condition. To verify that you have the proper drive model, check the model number listed on the drive serial plate.

Ship Kit Table	Part Description	Part Number
	BD-E Drive	See drive identification below
	BD User Guide	1600.208.XX
	Cable Set	BDCXXXX Where XXXX specifies cable length, for example BDC1500 specifies a 15 metre cable set.

Table 2-1. BD-E Drive Ship Kit

Systems may be shipped configured with drives and motors prewired or supplied as separate units.

Identification

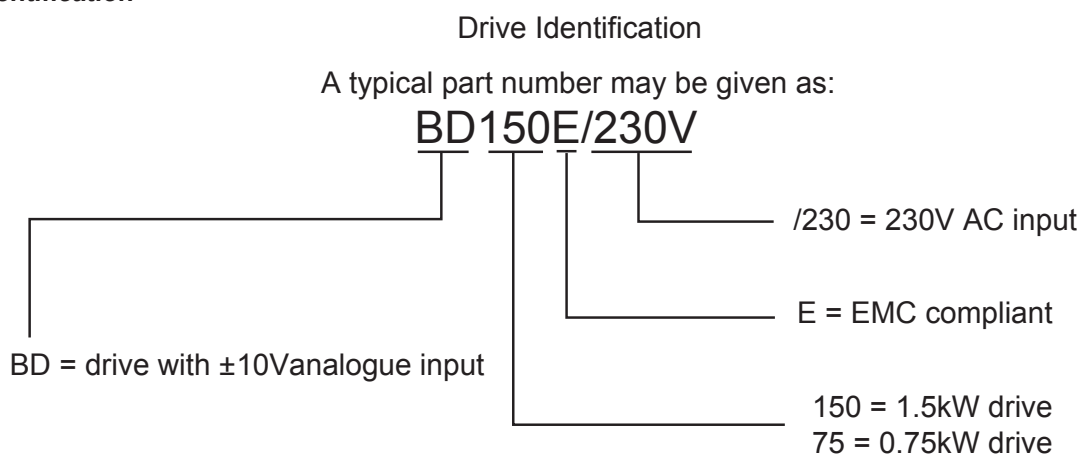

Figure 2-1. Drive Identification

Warning - risk of electric shock

If the drive mains earth becomes disconnected, the case and signal I/O lines will become live at 120V AC (limited to 10mA), due to the filter required for EMC compliance.

Pre-installation Test

This section provides procedures to help you to connect up your BD drive system for a pre-installation test. Please note the pre-installation test allows you to become familiar with the operation of the drive prior to permanent installation, it should only be set up and used by competent personnel familiar with installation of motion control equipment. The safety earth connection must be made as shown to minimise the risk of electric shock.

Figure 2-2 illustrates the pre-installation test configuration for systems operating from a 230V mains supply. Please note the following points:

- The motor should be securely clamped to the test bench before any power is supplied.

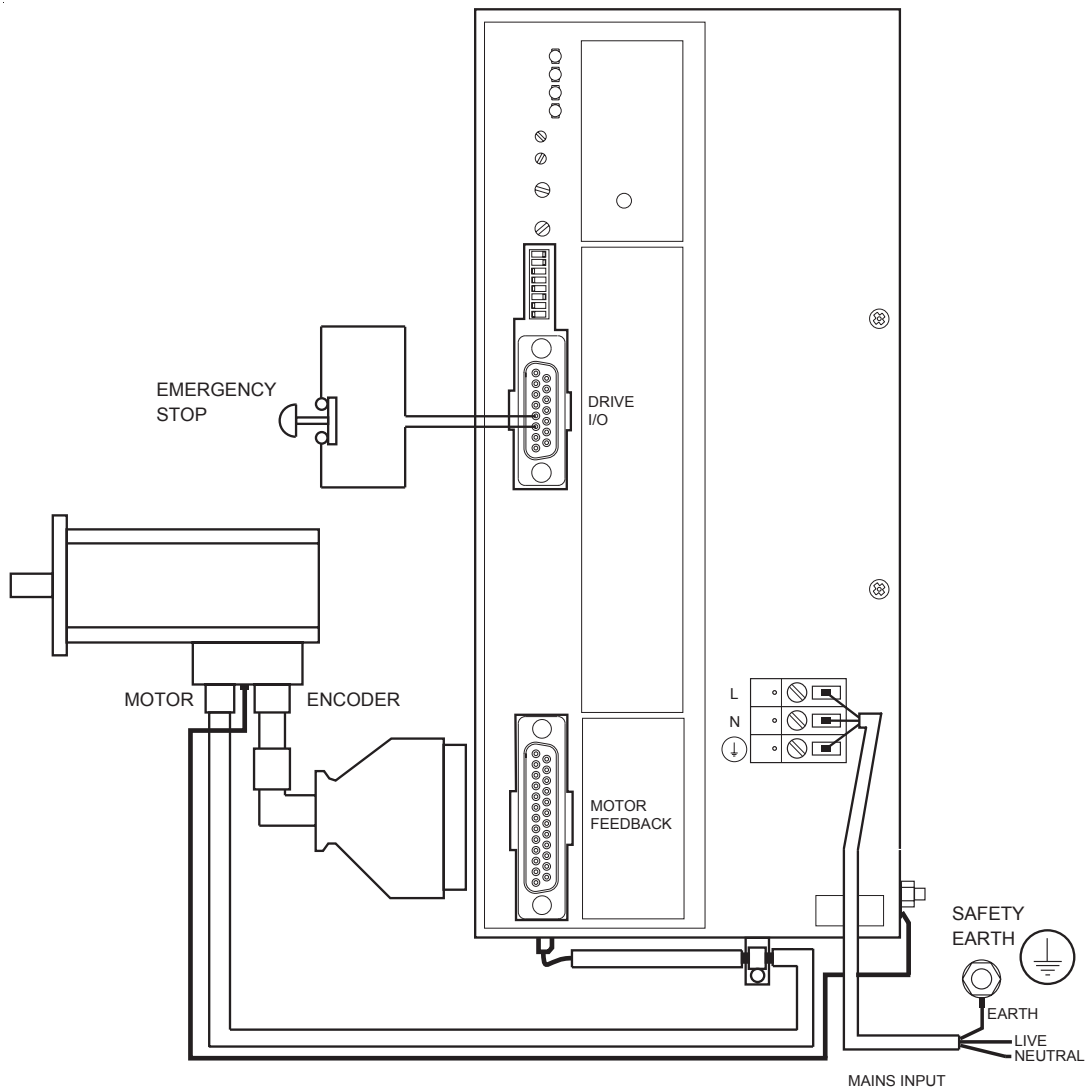

Figure 2-2. Pre-installation Test Configuration

1. Connect the Motor**WARNING - Electric Shock Hazard**

Ensure that AC power is disconnected before attempting to connect or disconnect the motor. Lethal voltages are present on the motor connectors.



Insert the plugs on the motor and encoder cables securely into the mating connectors on the motor housing and ensure that the locking rings are tight. Fit the drive end connectors to the corresponding sockets, ensuring that the motor cable screen is anchored under the P-clip (see Fig 2-2). Connect the motor safety earth as shown using 2.5mm² wire.

2. Connecting to an AC Supply

The BD-E Series of drives operate direct-on-line from a 220-240V AC input, with no isolating transformer. Please note that the safety earth connection is necessary to provide a return path for the leakage current flowing through line-to-earth capacitors fitted on the internal filter board. The AC input is connected directly to the front panel screw connectors, as shown in Figure 2-2.

Testing the BD System

1. Set the drive potentiometers as follows:

TIME CONSTANT	Fully CCW	
DAMPING	Fully CCW	
TACH GAIN	Fully CW	

2. The 8 bit switch is set to configure the drive for use with a particular motor/encoder combination. Set the 8 bit switch as follows:

Motor pole numbers

<u>Pole number</u>	<u>Switch 1</u>	<u>Switch 2</u>
6	OFF	OFF

Commutation encoder pull-up voltage

<u>Encoder pulled up to</u>	<u>Switch 3</u>
+5V	ON

Encoder resolution setting

<u>Encoder resolution</u>	<u>Switch 4</u>
1024	OFF

Note: Digiplan 3.4 inch motors have 1024 line encoders fitted.

The velocity/torque bit switch 5 should be set to OFF (velocity amplifier).

Bit switch 6 should be set to OFF, to de-energise the drive. When a link or switch is fitted between pins 5 and 6 of the Drive I/O Connector as shown in Figure 2-2, the drive will be energised. This provides a failsafe solution.

Note: a connection must be made between pins 5 and 6 of the Drive I/O connector to enable the drive.

Bit switches 7 and 8 should be both set to ON to minimise the motor current whilst setting up the drive.

3. Make sure that the motor is held securely and that the shaft is free to rotate.
4. Turn on the main AC supply.
5. Rotate the Balance control until the motor shaft remains stationary. Rotating the Balance control CW should cause the motor to rotate CW and therefore, rotating CCW should cause the motor to rotate CCW.
6. Motor rotation confirms that the drive is operating correctly. If the motor fails to rotate, re-check all connections and bit switch settings. If you do not discover the cause of the problem refer to the ***Maintenance & Troubleshooting*** section.

Section 3. INSTALLATION

Precautions

During installation, take the normal precautions against damage caused by electrostatic discharges. Earthed wrist straps should always be worn.

Environment

The drive system should be installed vertically in an area where there is at least a 50mm air gap all around the package. The distance required is, however, application dependent, and may vary according to the amount of heat generated by equipment mounted below the drive and by the drive itself. An integral fan draws air into the base of the drive and expels it through vents in the top panel. The ambient temperature must not be allowed to exceed 40°C if an operator has access to the case, or 50°C if operator access is not allowed.

The drive requires a mains supply of Installation Category II and can be used in an atmosphere of Pollution Degree 2. Humidity limits are 0-95% non-condensing.

Drive Dimensions

All BD drives are supplied as packaged units. Figure 3-1 shows the overall dimensions of the drive and the distance required between mounting holes.

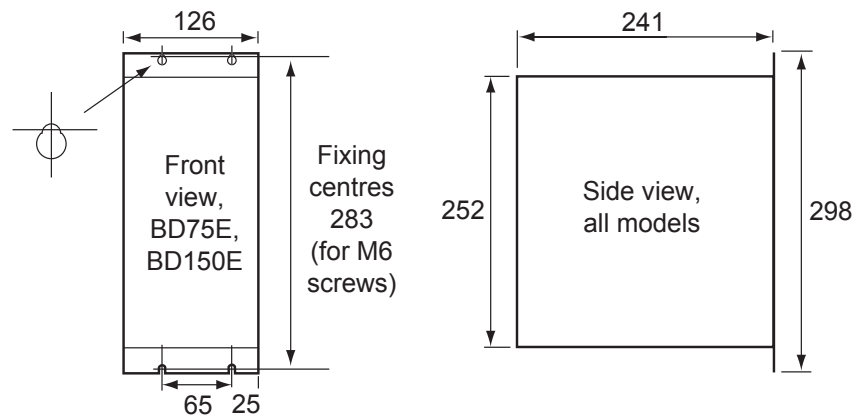

Figure 3-1. Drive Dimensions

Note: The dimensions given above do not allow for the room occupied by interface connectors.

CAUTION - Under certain operating conditions the top of the case may reach temperatures in excess of 70°C.

Drive Signal Connections

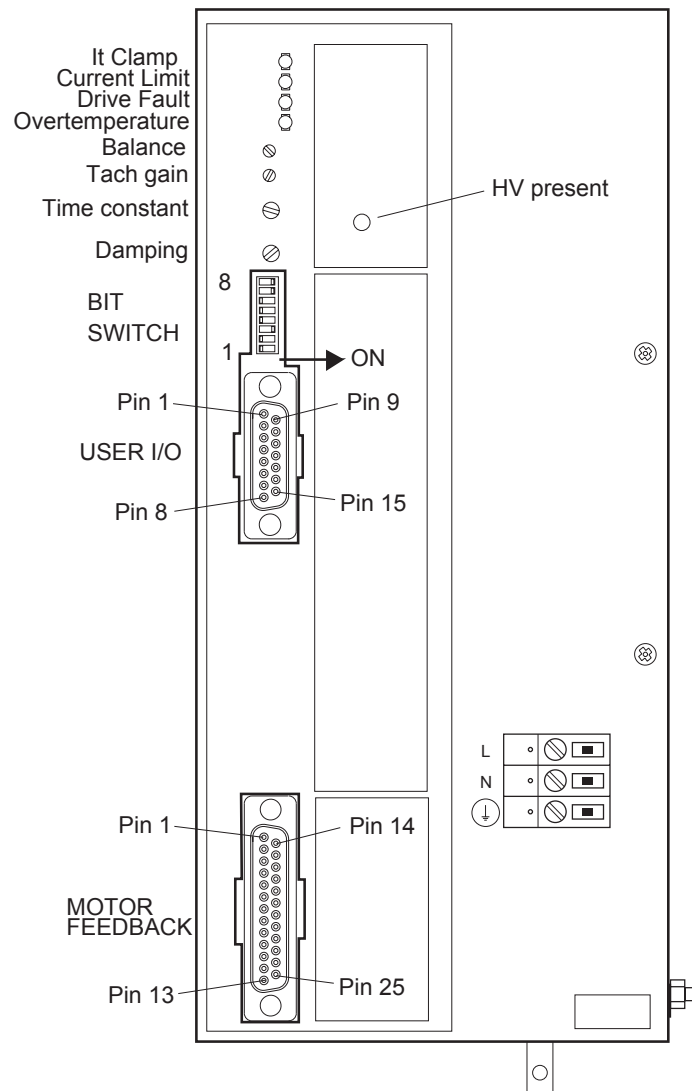

Figure 3-2. Connectors and Indicators

User I/O Connector

User I/O Connector
Pin Functions

Pin	Signal Name	Function
1	V2	±10V Analogue input
2	V1	±10V Analogue input
3	-15v	Reference voltage (current limited)
4	GND	Ground
5	$\overline{\text{RST}}$	*Reset
6	+15V	Reference voltage (current limited)
7	Tach Out	Tachometer monitor output
8	Curr. Level Out	Current monitor output
9	$\overline{\text{FT}}$	$\overline{\text{Fault}}$
10	**A+	A output from incremental encoder
11	A-	$\overline{\text{A}}$ output
12	B+	B output from incremental encoder
13	B-	$\overline{\text{B}}$ output
14	***I+	Z output from incremental encoder
15	I-	$\overline{\text{Z}}$ output

* 0V holds drive in permanent reset condition. 15V allows drive to energise.

** A+ leads B+ for CW motor rotation

*** I+ is a once-per-rev high-going pulse, covering at least $\frac{1}{4}$ of a channel A+ cycle and occurring when A+ and B+ are both high - see below:

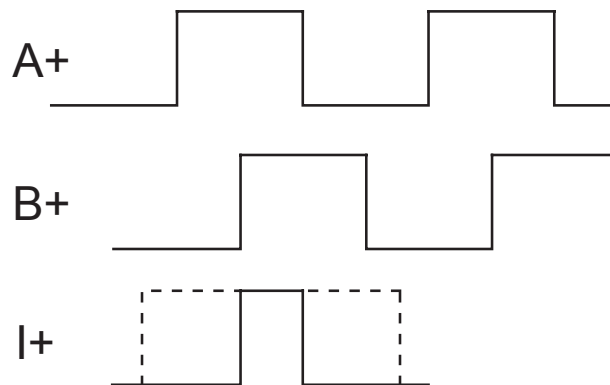

Table 3-1. User I/O Connector Pin Functions

User I/O Pin Description

The User I/O connector provides access to the main drive control signals. The function of each pin is described below.

Pin 1 (V2) & Pin 2 (V1)

Input pins 1 and 2 can act as differential analogue torque or velocity inputs, depending upon the state of bit switch 5. The input impedance to ground of both of these inputs is 30K.

In torque mode (bit switch 5 ON), 10V between V1 and V2 will produce maximum current, but you may restrict this by the setting of bit switches 7 and 8.

In velocity mode, $\pm 10V$ between V1 and V2 will produce a speed of 2500 rpm (using an MD 34-sized motor). These speeds assume the Tach Gain potentiometer is fully CW. You may increase these speeds by turning the Tach Gain potentiometer CCW.

When V1 is positive with respect to V2, the motor will rotate CW in both torque and velocity mode.

Pin 3 (-15V) & Pin 6 (+15V)

Pins 3 (-15V) & 6 (+15V) are current limited supplies (10mA max.) intended for use with Reset and analogue demand inputs.

If bit switch 6 is OFF, the Reset input will need to be pulled up to pin 6 to energise the drive, using a switch or PNP transistor. This will draw a current of 1mA from the +15V output.

If you require a manually adjustable velocity demand, a 50k ohm potentiometer can be connected between pins 3 and 6, with the slider connected to pin 2 and pin 1 connected to pin 4. This wiring configuration will also draw 1mA from the +15V and -15V outputs.

Pin 4 0V

Pin 4 is drive ground and is linked to mains earth via a high frequency filter.

Pin 5 Reset

Pin 5 is the reset input, when the input is low, the drive is de-energised. Any latched faults remain latched while the input is low and are reset on the high-going edge.

The reset input can be configured by bit switch 6. If bit switch 6 is OFF and the reset input is open circuit, this input is pulled down to 0V via a 15k ohms resistor and the drive is de-energised. To energise the drive, the reset input must be connected to +15V (pin 6 of the the user I/O connector) via a switch or a PNP transistor.

Note: this is the 'fail safe' configuration.

Note: When bit switch 6 is OFF a connection must be made between pins 5 and 6 of the Drive I/O connector to enable the drive.

If bit switch 6 is ON and the reset input is open circuit, the reset input is pulled up to +15V using a 15k ohm resistor and the drive is energised. To de-energise the drive you will need to connect this input to 0V (pin 4 of the user I/O connector).

Pin 7 Tach Output

Pin 7 is the internally buffered tachometer output. The output produces a signal of approximately 2V/krpm independent of line count. The output polarity is positive for CW motor rotation. This output is not intended for accurate speed calibration, but for use when setting up the drive.

Pin 8 Current Monitor

Pin 8 is a unipolar current monitor signal used to indicate the total motor current with a sensitivity of 2A/V for the BD150 (1A/V for the BD75). This output is not intended for accurate current calibration, but for use when setting up the drive.

Note: the output represents a rectified summation of the 3 actual motor phase currents thus, even when delivering a constant torque, the signal will contain approximately 13% ripple at low shaft speeds.

Pin 9 Fault Output

Pin 9 is an open collector fault output signal which goes low when a fault occurs. The output can be pulled up to a maximum voltage of +28V, and the output transistor can pass a maximum current of 25mA.

Pin 10 to 15 Encoder Outputs

Pins 10 to 15 are buffered encoder outputs using 26LS31 line drivers. Use twisted pair screened cable and 26LS32 line receivers or optos.

Note: Particular care should be paid to these outputs to prevent EMC radiation problems. When using line receivers - connect the screen to earth at both ends of the cable. In this configuration the drive and controller should be mounted close together sharing the same ground plane. For opto receivers - connect the screen to earth at the drive end only.

CAUTION - Avoid turning the Tach Gain potentiometer fully CCW in velocity mode. This will result in the motor running at maximum speed regardless of the input voltage.

Motor Feedback Connector

Motor Feedback Connector Pin Functions

Pin Number	Function	Lead Colour
1	Reserved	
2	0V	Blue
3	5V	Red
		} Twisted Pair
4	Tach 0V	See description
5	Tach input	See description
6	0V	Pink
7	Thermistor	Grey
		} Twisted Pair
8	I-	Green
9	I+	Yellow
		} Twisted Pair
10	B-	White
11	B+	Brown
		} Twisted Pair
12	A-	White/Yellow
13	A+	Yellow/Brown
		} Twisted Pair
14	Reserved	
15	0V	White/Pink
16	+5V	Pink/Brown
		} Twisted Pair
17	Reserved	
18	N	
19	C	
	NC	
20	Com C-	Black
21	Com C+	Violet
		} Twisted Pair
22	Com B-	Grey/Red
23	Com B+	Red/Blue
		} Twisted Pair
24	Com A-	White/Green
25	Com A+	Brown/Green
		} Twisted Pair

Table 3-2. Motor Feedback Connector Pin Functions

Motor Feedback Pin Description

The user motor feedback connector is a 25-way D-type which carries motor monitoring signals. Connection to the User I/O connector must be made using a metal cased backshell D-type connector and the securing screws must be fully tightened before use.

Pin 2 & 15 0V

0V return for +5V supply.

Pin 3 & 16 +5V

+5V current limited supply (200mA maximum). Take care to minimise any voltage drop when using cables longer than 10 metres.

Pin 4 Tach 0V

Tach input 0V return.

Pin 5 Tach Input

Tach input. The Tach input pins are not normally used. They are reserved for use with a brushed tachometer for high performance applications.

Pin 6 0V

0V return for thermistor.

Pin 7 Thermistor

For thermal protection of the motor, a normally closed thermal switch or a PTC thermistor mounted in the motor is connected between pins 6 and 7. The thermistor should have a transition resistance between 100R and 10k Ω .

Pins 8 to 13 Inc Encoder Inputs

The incremental encoder inputs are connected to a 26LS32 line receiver. The set up of the encoder is described in **Appendix A**.

Pins 20 to 25 Comm Encoder Inputs

The commutation encoder inputs are described in the section describing bit switch 3 settings and **Appendix A**.

Motor Connections

Motor connections are made via a 5-way spade terminal plug, mounted in the base of the drive. The motor cable terminating plug is shown in Figure 3-3.

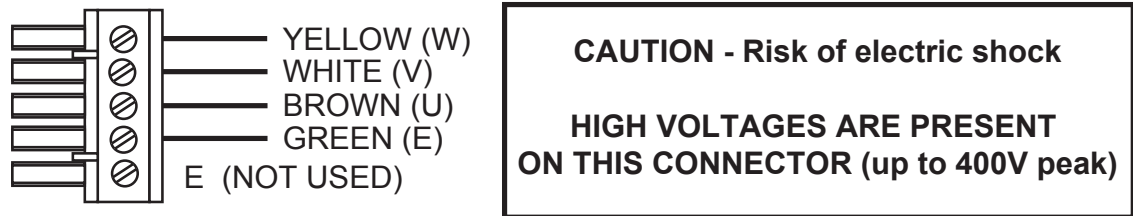

Figure 3-3. Motor Connector

Motor Connector Pin Functions

Signal Name	Lead Colour *
W	Yellow
V	White
U	Brown
E	Green
E	Not used

Table 3-3. Motor Connector Pin Functions

Rewiring the Motor Connections

The main motor cable has 5 leads and is terminated in a 5-way screw terminal connector. This connector is easily removed and refitted where necessary. The lead colours are shown in Table 3-3; make a note of where each colour wire is connected before proceeding and take particular care that the leads are reconnected correctly.

The cable used must have an insulation rating of greater than 1.35kV RMS.

Extending the motor and encoder leads

Unless the use of bulkhead connectors is unavoidable, it is preferable to make up entirely new leads rather than to extend the cables supplied, but the same connector types must be used and screens must be correctly terminated. The following cable types may be used for this purpose:

Motor cable	Lapp LiYCY 0034804
Encoder cable	Lapp LiYCY 0035805

Connection details will be found in Tables 3-2 to 3-3. When making up new cables, make a careful note of how the original cable is terminated and ensure that the new cables are arranged in exactly the same way. Remember that the ferrite absorber must be fitted on the encoder cable close to the drive. Note that the encoder cable is slightly longer than the motor cable to allow for the different connector locations at the drive end. Please consult Digiplan if you propose to extend the motor and feedback leads beyond 30 metres.

Cabinet Mounting Requirements

Figure 3-4 shows the necessary earthing and EMC compliance wiring arrangements you need to make when installing the drive within an equipment cabinet.

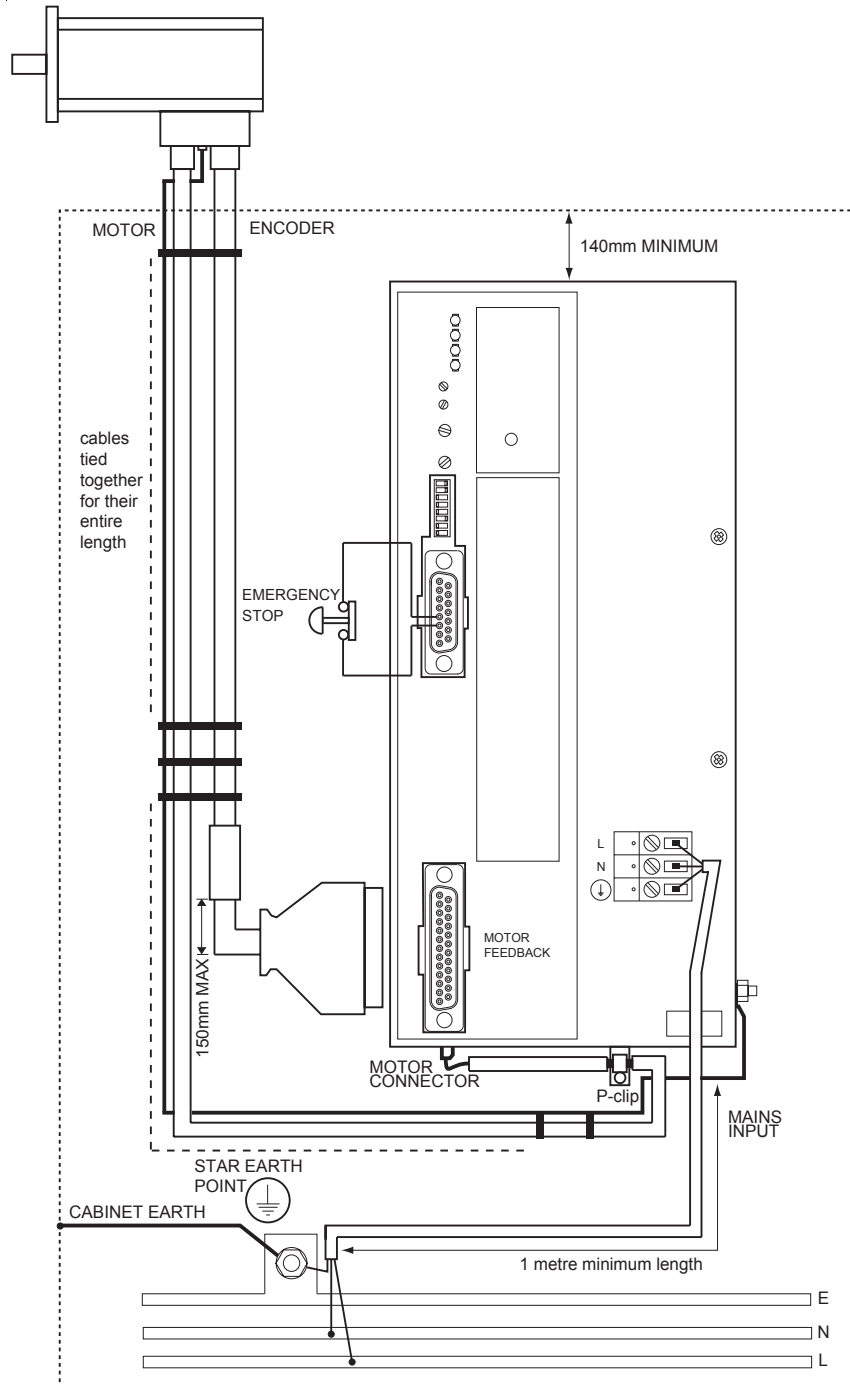

Figure 3-4. Cabinet Mounting

Cable routing

The mains cable should have a minimum length of 1 metre and needs to be terminated close to where the mains earth connection is made. The safety earth lead, connected to the stud on the side of the drive, needs to be closely routed with the mains lead. The motor and encoder cables must run in close proximity and routed together for their entire length back to the drive. Unless the cables are laid alongside each other in trunking, use cable ties every 500mm to anchor the two cables together.

Where the cables have to pass through a panel or bulkhead, the integrity of the screen must be preserved. Where possible, avoid using a connector. If a connector must be used, it should have a full metal shroud which makes a 360° connection to the cable screen on both sides. The body of the connector must be electrically isolated from any earthed metalwork - it may be mounted on a separate panel insulated from the bulkhead.

Motor and Encoder Connections

The encoder cable has a 25-way D connector at the drive end which is plugged into the 'Motor Feedback' socket on the drive. Tighten the jacking screws firmly. The metal housing on this connector must not be removed. The encoder cable is fitted with a ferrite absorber at the drive end which is essential for EMC compliance. This should be kept as close as possible to the drive-end connector and not more than 150mm away.

The 5-way spade connector on the motor cable fits a mating connector on the base of the drive. The exposed cable screen must be securely anchored under the clip adjacent to the connector - this is an essential requirement.

AC supply connections

If a plug is used for AC supply connections it must conform to IEC309.

Warning - risk of electric shock

If the drive mains earth becomes disconnected, the case and signal I/O lines will become live at 120V AC (limited to 10mA), due to the filter required for EMC compliance.

AC supply connections are made using the front panel screw connector. This should be wired using 1.5mm² 3-core mains cable. Do not wire the AC supply using individual leads running in a conduit. The circuit should be protected by a 16A circuit breaker, and the isolator must break both the live & neutral lines.

For permanently connected equipment, the switch should be marked as the disconnecting device and should be mounted close to the equipment within easy reach of the operator.

Earth leakage current

The AC supply to the BD-E drive is internally filtered to achieve EMC compliance. The filter components create an earth leakage current of the order of 10mA, which is compatible with standard residual-current breakers operating at 30mA. The BD-E drive is not suitable for use on supplies employing high-sensitivity RCD breakers.

Motor safety earth connection

It is essential that there is a safety earth connection to the motor housing. A separate earth lead must therefore be taken from the earth terminal on the motor, routed with the motor and encoder leads and terminated at the safety earth stud on the side of the BD-E. The motor earth terminal is located between the motor and encoder sockets. The safety earth lead should be at least 2.5mm² in area.

Control signal connections - BD-E

The analogue input signal should be carried in a twisted-pair screened cable with the screen connected to the connector shell on the drive and to the appropriate ground on the controller. The encoder output signals should be similarly carried in twisted-pair screened cable.

Using an External Positioner

The incremental encoder incorporated in the motor may be used to provide position information to an external positioner. Terminals 10-15 on the User I/O connector provide the true and complementary signals from all three encoder channels (see Table 3-3). These outputs are generated by 26LS31 line drivers.

Note: Particular care should be paid to these outputs to prevent EMC radiation problems. When using line receivers - connect the screen to earth at both ends of the cable. In this configuration the drive and controller should be mounted close together sharing the same ground plane. For opto receivers - connect the screen to earth at the drive end only.

Setting Up the Drive

Application Types

There are two basic types of applications (described below) for the BD servo drive. Each type of application requires a different type of tuning.

Velocity Following

For this application, it is required that the axis follows programmed velocities as accurately as possible. A high amplifier gain is needed so that the small signals resulting from small velocity errors will produce large correcting torques.

Torque Amplifier

In this type of application, the torque produced is required to be proportional to the input voltage. Low amplifier gain is needed in this case. The torque produced directly relates to the motor current. For example, a gain of 1A/Volt would produce 1A of motor current for each volt at the input ($\pm 10V$ at the input would produce $\pm 10A$ of motor current).

Initial Precaution

Before starting to tune the drive ensure that the motor mechanism is clear of obstructions. Position the mechanical system at the mid-position of its total travel. Do not allow the motor to remain unstable for more than a second or two.

Setting the Drive Bit Switches

Depending on how you want to use the drive, you may need to change some of the factory-set bit switches. The factory settings shown in Figure 3-5 are suitable for the MD motor only.

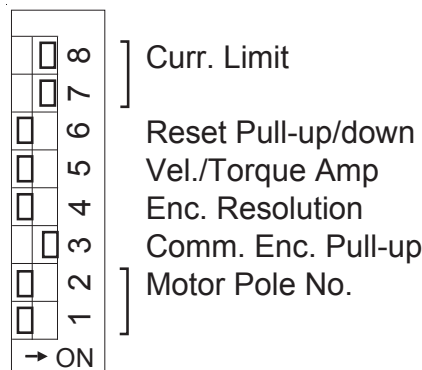

Figure 3-5. Bit Switch Settings

Note: When bit switch 6 is OFF a connection must be made between pins 5 and 6 of the Drive I/O connector to enable the drive.

Tuning the BD Drive

The appropriate tuning procedure should be carried out on each axis. The procedures in this section assume that you have completed the connection and test procedures provided in Sections 2 and 3. The motor should be coupled to the load at this stage.



Tuning for use as a Velocity Amplifier

Use the following procedure to tune the drive.

Step 1 - Set bit switches.

Step 2 - Make sure the power to the drive is off and that the motor is held securely and the shaft is free to rotate.

Step 3 - Adjust the front panel controls as follows:

TIME CONSTANT	Fully CCW	
DAMPING	Fully CCW	
TACH GAIN	Fully CW	

Step 4 - Apply zero velocity demand to the input by connecting both signal inputs (VEL1 and VEL2) together.

Step 5 - Switch on the power to the drive. Should the motor rotate, adjust the Balance potentiometer in the opposite direction to the motor rotation until stationary.

If any fault LEDs illuminate, refer to the **Maintenance & Troubleshooting** section.

Step 6 - Set the velocity amplifier sensitivity by applying a signal of 20% of maximum input (2V for $\pm 10V$ operation) and adjusting the Tach Gain 20-turn potentiometer to give 20% of maximum speed. Use the Tach monitor output (User I/O connector pin 7) to measure rotation speed.

Step 7 - Reduce the input signal to zero to stop the motor.

Step 8 - Rotate the Time Constant control clockwise until the motor shaft starts to oscillate (characterized by a high-pitched ringing sound). Optimum drive performance is achieved at the point when the motor first starts to ring. Do not allow the motor to oscillate for more than a second or two.

Step 9 - Increase the input signal to run the motor at high speed (**not full speed**) and check for smooth behaviour. If there is excessive noise or vibration, try turning the Time Constant control anti-clockwise.

Step 10 - Periodically apply and remove short 20% velocity input signal pulses at approximately 1-second intervals. If the control system will not permit this method of control, remove the signal connections and use a separate DC power source (i.e., a battery or a DC power supply) to provide the signal.

The object is to observe the motor response to each input pulse, using an oscilloscope attached to the Tach monitor output. The optimum response will be slightly damped with no "ringing" of the waveform.

Step 11 - Remove the input signal and ground VEL1 and VEL2 to each other, and, if necessary, readjust the Balance control until the shaft remains stationary.

Setting up the Drive as a Torque Amplifier

Use the following procedure to tune the drive.

Step 1 - Set bit switches. Bit switch 5 ON.

Step 2 - Make sure the power to the drive is off and that the motor is held securely and the shaft is free to rotate.

Step 3 - Adjust the front panel controls as follows:

TACH GAIN	Fully CCW	↶
DAMPING	Fully CCW	↶
TIME CONSTANT	Fully CW	↷

In some torque amp applications it is necessary to set an accurate torque amp gain (i.e. Amps/Volt or Nm/Volt). This can be achieved using an external potentiometer introduced between the V1 and V2 inputs of the drive, as shown in Figure 3-6.

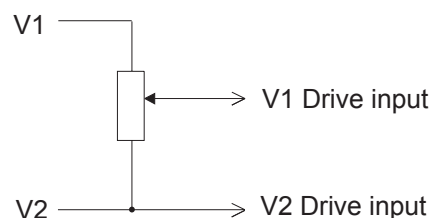

Figure 3-6. Circuit for accurate torque amp gain setting

Section 4. HARDWARE REFERENCE

BD Drive Specification

	BD75	BD150
Continuous Current	3A	6A
Peak current	6A	12A
DC bus Voltage	325V	325V
AC Input Voltage: Nom.	230V	230V
Max.	264V	264V
Min.	207V	207V
Frequency	47-63Hz	47-63Hz
Power continuous	0.75kVA	1.5kVA
Peak power	1.5kVA	3.0kVA
Weights kg (lb)	6.5 (14)	6.5 (14)
Motor Options	MD3450/ MD3475	MD3450/ MD3475

Power input	AC direct from mains
Control input	±10V analogue (torque or velocity)
Reference outputs	±15V at 10mA
Velocity feedback	Built-in incremental encoder
Switching frequency	10Khz
Velocity mode gain	5000
Torque amp gain	10V input gives peak current
Max. cont. dump power	96W
Peak dump power	4.5kW
Bit switch settings	current limit, reset pull-up, vel/torque, encoder res., comm. enc. pull-up, motor pole numbers
Potentiometer settings	Time constant, damping, balance, tach gain
Diagnostic LED's (Front)	IT clamp, current limit, drive fault, overtemperature, HV present
Dimensions	See Figure 3-1

Table 4-1. BD Servo Drives Specification

Brushless Motor/Drive Packages

The BD Series drives may be matched with motors in the Digiplan brushless range and supplied as ready-wired motor/drive packages. Details of motors are given in Table 4-2.

Type	Weights (including cable)	Rotor Inertia Kg-cm ²	Incremental Encoder Line Count
MD-3450/230	5.1Kg	1.6	1024
MD-3475/230	6.4Kg	2.4	1024

Table 4-2. Brushless Motor Data

The dimensions of the motors are shown in Figures 4-1.

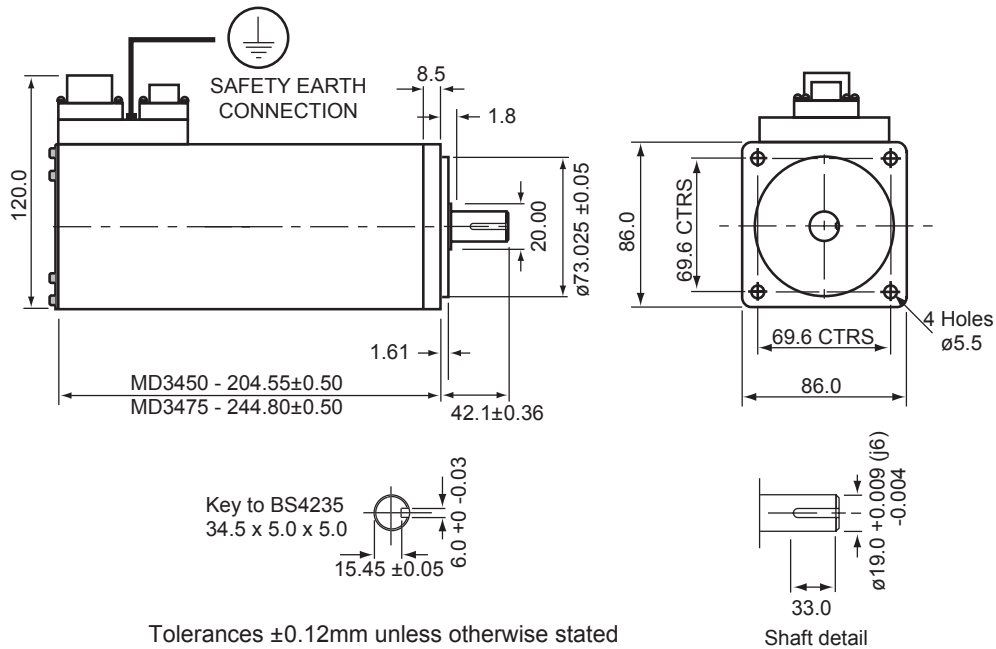

Figure 4-1. Motor Type MD3450/3475 Dimensions

Motor IP rating

The motor has an IP54 rating, except for the shaft.

Caution - High temperatures
Motor temperature will exceed 100°C before the over-temperature trip operates.

Motor/Drive Package Performance Data

The torque curves for the possible motor/drive combinations are shown in Figure 4-2.

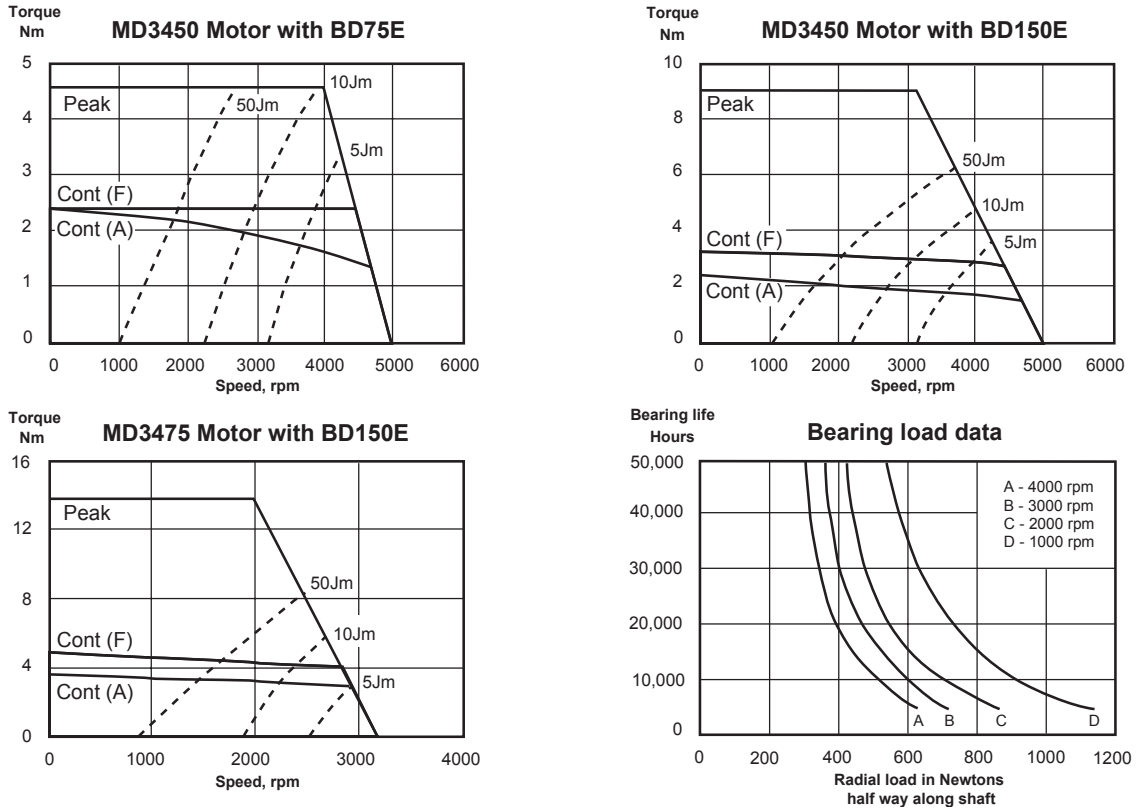

Figure 4-2. Motor/Drive Packages Torque Curves

Regenerative Dump Considerations

The dump circuit fitted to the BD drive operates when the bus voltage exceeds a fixed level, rather than when it exceeds the peak AC input voltage. The dump load has a continuous capacity of 96W and a peak power of 4.5kW.

A family of dump curves is shown super-imposed on the motor torque-speed curves. These curves (representing system inertias of 5, 10 and 50 times the motor inertia) show the maximum speed of a repeated trapezoidal move that can be achieved without the need for additional dump resistors. The area to the left of each curve (and beneath the peak torque curve) represents a guaranteed safe operating area. The curves show the worst case conditions (i.e. maximum motor temperature rise, nominal bus voltage at the start of braking and braking carried out in current limit). If one or more of these conditions does not apply, it may be possible to operate to the right of the safe area, but this would need to be proven by experimentation.

For a single deceleration in current limit, the maximum system inertia which may be braked from the maximum speed (approximately 55 rps) is 125 kg cm², without any danger of blowing the dump fuse.

Radial Loads

The 'Bearing load data' graph shown above, provides an estimate of the maximum radial load that can be tolerated at a particular motor speed, when set against the bearing life of a system. For example, if a typical bearing life expectancy of 20,000 hours was chosen as being reasonable for a system operating at a speed of 2000rpm, the maximum radial load that could be tolerated is 550N.

Fuses

BD drives are fitted with fuses which limit circuit damage in the event of a fault occurring, they are not user replaceable. If the drive fails to operate correctly or you suspect a fuse has blown return the drive for repair. See **Returning The System** in the **Maintenance and Troubleshooting** section. Warranty is void if the case is opened.

Cable Sets

Ready-made cable pairs are available in the following lengths:

Part No.	Cable length
BDC-10	3m (10ft)
BDC-25	7.5m (25ft)
BDC-50	15m (50ft)
BDC-100	30m (100ft)

Table 4-3. Cable Sets

Encoders

The BDE1024/6 is a 1024 line, 6 pole self-contained encoder that can be used with motors from other suppliers.

Section 5. MAINTENANCE & TROUBLESHOOTING

Drive Maintenance

Routine maintenance is not necessary, but occasional checking of the following points is recommended.

Motor Maintenance

Periodically check the motor to ensure that no bolts or couplings have become loose during operation, and check the motor cable or leads periodically for signs of wear. Do not make very tight bends or pull on the cable during normal operation. Check all cable connectors and the safety earth connection.

Drive Maintenance

Check that the drive is clear of loose material and has a free flow of air through the ventilation slots. Check all drive connector jacking screws are firmly tightened and the motor screen connection is secure.

Fuses

BDE drives are fitted with fuses which limit circuit damage in the event of a fault occurring, they are not user replaceable. If the drive fails to operate correctly or you suspect a fuse has blown return the drive for repair. Warranty is void if the case is opened.

Troubleshooting

Drive or system problems may be indicated by one of the front panel LEDs lighting up whilst the drive is operating.

Note: The central 'HV Present' LED will always be alight whilst the DC bus voltage is present. This does not necessarily mean that the internal logic supplies are present. The LED will remain alight even when mains power is removed, as the high voltage capacitors will still be charged.

WARNING - Danger of electric shock

Lethal voltages are present on the mains input connector and the motor phase outputs. After removing AC power, wait for the 'HV Present' LED to go out before touching the drive terminals. Do not remove the drive cover, there are no user-serviceable parts inside. Removal of the cover voids the warranty and EMC compliance.

Protection Circuits

The BD Drive has a number of protection circuits which automatically prevent damage occurring during fault conditions. If a fault does occur it will cause a front panel LED to light up and may de-energise the drive.

The front panel LED indicators are described below.

IT Foldback

If the IT foldback yellow LED comes on, it means the drive has been required to deliver too much current for too long a time period. In this situation the drive will automatically reduce the motor current to below 60% of the peak current.

IT foldback will occur if the drive is required to deliver its full output current for more than 5ms at a speed of less than 6rps. The full current limit will be restored as soon as the conditions causing IT foldback have been removed.

Current limit

The yellow I limit LED indicates that the current demand is exceeding the drives maximum current capability. Note: The motor current level can be adjusted using bit switches 7 and 8.

Drive Fault

The red drive fault LED can indicate one of the following faults:

- Overvoltage
- Undervoltage
- Supply failure
- Overcurrent
- Overspeed

An overvoltage condition may be caused by:

- Excessive AC power input voltage
- A fault in the dump circuit
- The application requires a larger dump capacity

An under voltage condition may occur if the AC input power voltage drops when the maximum drive power is drawn from the supply i.e. poor AC supply regulation.

A supply failure may indicate a short circuit exists in the encoder or other external wiring, or it could be due to a fault in the internal power supply. If the fault is still being indicated when all external wiring is disconnected, the drive is probably faulty.

An overcurrent fault, indicated by the illumination of the drive fault LED and the red overcurrent LED mounted within the case, can be caused by a shorted motor winding or a drive fault. If the fault is still indicated when the motor is unplugged, the drive may be faulty.

An overspeed fault means that the motor has exceeded the factory-set overspeed threshold. If your application requires very high speed performance, please contact Digiplan for advice.

Overtemperature

The overtemperature LED will come on if the drive or motor is operating outside its specified continuous rating, requiring the duty cycle to be reduced.

If the motor feedback connector becomes disconnected, the thermal switch will appear to have opened and the drive will de-energise, indicating an overtemperature fault. This fault condition is latched until the drive is reset.

Incorrect Operation

Noise from Motor or Unstable Motor Operation

This is usually caused by the Damping or Time Constant controls requiring adjustment. Re-adjustment of either of these two controls should cure this. If none of these checks has isolated the problem then substitution of the drive (if possible) should be used to prove whether or not the drive module is at fault.

Motor Creep

This is usually caused by an incorrect setting of the Balance control, so first check this setting by confirming that there is zero velocity command on V1 and V2 inputs. Then adjust the Balance control until the motor shaft is stationary.

Ensure that all signals are supplied in twisted pairs or screened cables.

If none of these steps resolves the problem then try substitution of the drive module to prove if the drive is at fault.

Internal Fuses

Three internal fuses are fitted to limit circuit damage in the event of an internal failure. Should any of these fuses blow the drive should be returned for repair. Users should not replace fuses.

Returning the System

Contact the Parker Automation Technology Centre or the machinery manufacturer who supplied the product. Equipment for repair should NOT be returned directly to Digiplan without prior authorisation. Repairs will be carried out by Digiplan but will be processed via your supplier.

Digiplan may at their discretion authorise direct shipment to and from Poole or Rohnert Park, but only by prior arrangement with your supplier. Existing UK and USA customers who purchase equipment directly from Digiplan should contact Poole or Rohnert Park for further information (contact numbers are at the front of this User Guide).

Appendix A. ENCODER SETUP

Introduction

This section is applicable when the BD drive is not used with Digiplan MD Series motors.

BD drives are designed to operate with 3-phase brushless servo motors which have both a commutation encoder (Hall effect encoder) and an incremental encoder fitted. The commutation encoder must have Com A leading Com B by 120° electrical and Com B leading Com C by 120° electrical, and must have the same pole count as the motor. The incremental encoder must have 512 or 1024 lines, with A+ leading B+ for clockwise (CW) motor rotation. The I+ output is a high going pulse that occurs when A+ and B+ are high and is shorter than one complete cycle of A+ (see Table 3-1 waveform diagram).

Commutation

When power is first applied to the drive, the commutation encoder is used to establish a torque angle of approximately 90° electrical, so that 87% smooth motor torque can be achieved immediately. Once the motor has moved through 180° electrical, it will have passed an edge of Com A, achieving a more accurate setting of the torque angle, allowing 95% torque to be obtained. Following a complete revolution, the motor will have received an index pulse which provides the most accurate position information allowing 100% torque to be applied. The index pulse also acts as a continual check on the electrical position.

Encoder Setup

When setting up the encoders, disconnect the motor cable from the drive, but leave the encoder cable connected and the drive powered up but de-energised. Select any motor phase, say 'u' in Figure A-1, and take it to the negative connection of a DC power supply, as shown. Connect the other two motor phases to the power supply positive connection via power diodes.

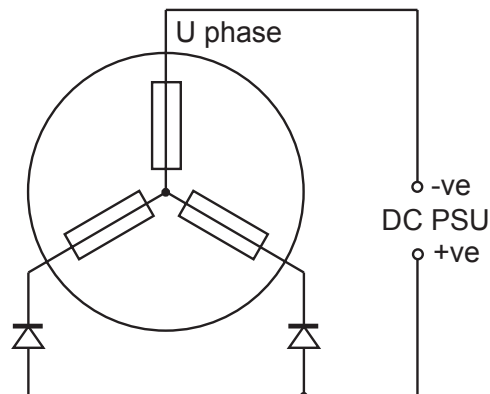

Figure A-1. Encoder Set-up Circuit

The DC power supply should be set to provide a current approximately equal to the motor's stall current. This will pull the rotor into the index position.

To identify the 'v' or 'w' phase, disconnect one of the diode connected phases, if the motor moves CW the 'v' phase has just been disconnected. If the motor moves CCW, you have just removed the 'w' phase.

The index position can be confirmed by the illumination of the middle yellow LED on the top of the drive. The commutation A LED will also light up when the motor is turned CW indicating the rising edge of Comm A+.

Bit Switch Setup

The bit switch can be used to configure the drive for different motor/encoder types.

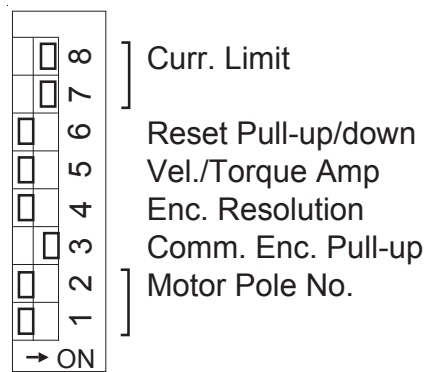

Figure A-2. Bit Switch Settings

Motor Pole Number

Bit switches 1 and 2 are set to the number of motor poles as follows:

<u>Number of Poles</u>	<u>Switch 1</u>	<u>Switch 2</u>
4	OFF	ON
6	OFF	OFF
8	ON	OFF

Commutation Encoder Pull up Voltage

The BD drive may be used with the following types of commutation encoders:

- Open collector outputs (single ended or complementary)
- TTL outputs (single ended or complementary)
- Line driver outputs

The bit switch 3 selects the pull-up voltage for the commutation encoder inputs:

<u>Function</u>	<u>Switch 3</u>
Inputs pulled up to +15V	OFF
Inputs pulled up to +5V	ON

Open collector outputs will require a setting of +15V, whilst line driver and TTL outputs should be set to +5V. Please contact Digiplan if the open collector option is required.

Encoder Resolution

The BD drive can be used with incremental encoders having a resolution of 512 or 1024 lines per revolution. After processing, the encoders would effectively produce 2048 and 4096 steps/rev respectively.

<u>Function</u>	<u>Switch 4</u>
512 lines per revolution	ON
1024 lines per revolution	OFF

Note: Digiplan 3.4 inch motors are fitted with a 1024 line encoder.

Velocity or Torque Amplifier

The BD drive would normally be used as a velocity amplifier, in which case the bit switch 5 is set as follows:

Switch 5 OFF

To use the drive as a torque amplifier (so that input voltage now determines torque rather than velocity), set the bit switch 5 as follows:

Switch 5 ON

When the drive is used as a torque amplifier, turn the Time Constant control fully CW, the Damping control fully CCW and the Tach gain potentiometer fully CCW.

Polarity of the 'Reset' Input

The reset input circuit can be configured as a normally open (pull-up) or a normally closed (pull-down) input, as shown in Figure A-3.

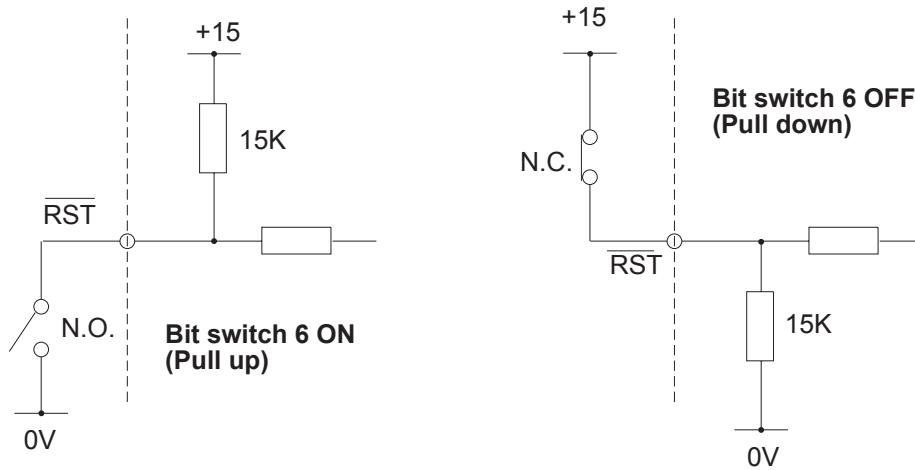

Figure A-3. Reset/Disable Input Circuit Options

Set bit switch 6 as follows:

<u>Function</u>	<u>Switch 6</u>
Reset pulled down to 0V	OFF
Reset pulled up to +15V	ON

Current Limit

Bit switches 7 and 8 are used to set the peak motor current as follows:

<u>BD75E Current Limit</u>	<u>BD150E Current Limit</u>	<u>Switch 7</u>	<u>Switch 8</u>
6.0A	12.0A	OFF	OFF
4.2A	8.5A	OFF	ON
3.0A	6.0A	ON	OFF
2.5A	5.0A	ON	ON

The minimum current setting should be used for tuning the drive. Once tuning is complete, the required setting should be selected.

It is normal to set the peak current at approximately 3 times the continuous current rating of the motor. The table below shows the allowable peak current for each motor size:

Motor	Peak Current
MD3450/230V	15A RMS
MD3475/230V	30A RMS

Table A-1. Motor Peak Current Rating

Index

- AC supply connections 20
- Analogue demand supplies 12

- Balance control 33
- Balance potentiometer 4
- Bit switch 4
- Bit switch adjustment 22
- Bit switch function 4
- Bit switch settings for test 7
- Bit switch setup 36

- Cabinet installation 19
- Cable length 18
- Cable routing 20
- Cables routed through bulkheads 20
- Commutation 35
- Commutation LEDs 3, 36
- Connector identification 10
- Control signal connections 21
- Current limit LED 3, 32

- Damping potentiometer 4
- Determining the phase 36
- Drive dimensions 9
- Drive fault LED 3, 32
- Drive maintenance 31

- Earth leakage current 21
- Electrostatic precautions 9
- Encoder pull up voltage 37
- Encoder resolution 37
- Encoder setup 35
- Environment 9

- Feedback connector fault
(overtemperature) 33
- Ferrite absorber 20
- Fuses 30

- Hall effect encoder 35
- HT LED 2
- Humidity limits 9
- HV present LED 3, 31

- Incremental encoder inputs 16

- It foldback LED 3, 32

- LEDs 2

- Motor cables extending 18
- Motor cables voltage rating 17
- Motor connections 17
- Motor connections re-wiring 17
- Motor creep 33
- Motor IP rating 28
- Motor maintenance 31
- Motor peak currents 39
- Motor pole number 36
- Motor safety earth 21
- Motor selection 28

- Noise from Motor 33

- Overspeed fault 33
- Overtemperature LED 3, 33
- Overvoltage condition 32

- Positioner (external) 21
- Potentiometer settings for test 7
- Potentiometers 4
- Pre-installation test 6
- Product description 1
- Product features 2
- Protection circuits 32

- Radial loads 30
- Reset input 13
- Reset input polarity 38
- Reset supplies 12
- Returning the System 34

- Ship kit 5

- Tach gain potentiometer 4
- Tach input 16
- Temperature of operation 9
- Test configuration (pre-installation) 6
- Testing the BD 7
- Thermistor transition resistance 16
- Time constant potentiometer 4
- Torque amplifier 22

42 INDEX

Torque amplifier setup 24
Troubleshooting 31
Tuning (velocity amplifier) 23
Tuning methods 22
Tuning the drive 23

Unstable motor operation 33
User I/O Connector 12
User I/O pin description 12

Velocity amplifier 23, 37
Velocity demand (adjustable) 13
Velocity following 22



Artisan Technology Group is your source for quality new and certified-used/pre-owned equipment

- FAST SHIPPING AND DELIVERY
- TENS OF THOUSANDS OF IN-STOCK ITEMS
- EQUIPMENT DEMOS
- HUNDREDS OF MANUFACTURERS SUPPORTED
- LEASING/MONTHLY RENTALS
- ITAR CERTIFIED SECURE ASSET SOLUTIONS

SERVICE CENTER REPAIRS

Experienced engineers and technicians on staff at our full-service, in-house repair center

*InstraView*SM REMOTE INSPECTION

Remotely inspect equipment before purchasing with our interactive website at www.instraview.com ↗

WE BUY USED EQUIPMENT

Sell your excess, underutilized, and idle used equipment. We also offer credit for buy-backs and trade-ins. www.artisanng.com/WeBuyEquipment ↗

LOOKING FOR MORE INFORMATION?

Visit us on the web at www.artisanng.com ↗ for more information on price quotations, drivers, technical specifications, manuals, and documentation

Contact us: (888) 88-SOURCE | sales@artisanng.com | www.artisanng.com