



## Artisan Technology Group is your source for quality new and certified-used/pre-owned equipment

- FAST SHIPPING AND DELIVERY
- TENS OF THOUSANDS OF IN-STOCK ITEMS
- EQUIPMENT DEMOS
- HUNDREDS OF MANUFACTURERS SUPPORTED
- LEASING/MONTHLY RENTALS
- ITAR CERTIFIED SECURE ASSET SOLUTIONS

### SERVICE CENTER REPAIRS

Experienced engineers and technicians on staff at our full-service, in-house repair center

### *InstraView*<sup>SM</sup> REMOTE INSPECTION

Remotely inspect equipment before purchasing with our interactive website at [www.instraview.com](http://www.instraview.com) ↗

### WE BUY USED EQUIPMENT

Sell your excess, underutilized, and idle used equipment. We also offer credit for buy-backs and trade-ins. [www.artisanng.com/WeBuyEquipment](http://www.artisanng.com/WeBuyEquipment) ↗

### LOOKING FOR MORE INFORMATION?

Visit us on the web at [www.artisanng.com](http://www.artisanng.com) ↗ for more information on price quotations, drivers, technical specifications, manuals, and documentation

**Contact us:** (888) 88-SOURCE | [sales@artisanng.com](mailto:sales@artisanng.com) | [www.artisanng.com](http://www.artisanng.com)

**Parker Hannifin plc**  
**Digiplan Division**  
21 Batena Close  
Poole, Dorset  
England, BH17 7DX  
Tel: 0202 690911  
Fax: 0202 600820  
Telex: 417217

**Parker Hannifin Corporation**  
**Digiplan Division**  
5500 Business Park Drive  
Rohnert Park, CA 94928, USA  
Tel: 0101 800 358 9070  
Fax: 0101 707 584 8015

*Digiplan, Compumotor and Daedal form part of the Parker Hannifin Applied Technologies Group. Products include stepper, brush and brushless servo systems, controllers and positioning stages, as well as complete custom-designed systems.*



# Digiplan

Electronic Motion Control

## MC20 Keypad Indexer User Guide





### SAFETY WARNING

High-performance motion control equipment is capable of producing rapid movement and very high forces. Unexpected motion may occur especially during the development of controller programs. **NEVER** touch machinery driven by a stepper or servo motor unless you are absolutely certain that it is safe to do so.

High voltages exist within enclosed units, on rack system backplanes (motherboards) and on transformer terminals. Avoid contact with these areas and refer servicing to qualified personnel.

# Important User Information

To ensure that the equipment described in this user guide, as well as all the equipment connected to and used with it, operates satisfactorily and safely, all applicable local and national codes that apply to installing and operating the equipment must be followed. Since codes can vary geographically and can change with time, it is the user's responsibility to identify and comply with the applicable standards and codes. **WARNING:** Failure to comply with applicable codes and standards can result in damage to equipment and/or serious injury to personnel.

Personnel who are to install and operate the equipment should study this user guide and all referenced documentation prior to installation and/or operation of the equipment.

In no event will the provider of the equipment be liable for any incidental, consequential, or special damages of any kind or nature whatsoever, including but not limited to lost profits arising from or in any way connected with the use of this user guide or the equipment.

© *Digiplan Division of Parker Hannifin plc, 1991*  
– *All Rights Reserved* –

The information in this user guide, including any apparatus, methods, techniques, and concepts described herein, are the proprietary property of Parker Digiplan or its licensors, and may not be copied, disclosed, or used for any purpose not expressly authorised by the owner thereof.

Since Parker Digiplan constantly strives to improve all of its products, we reserve the right to change this user guide and equipment mentioned therein at any time without notice.

---

## User Guide Change Summary

---

The following is a summary of the primary changes to this user guide since the last version was released. This user guide, version 1600.131.02, supersedes version 1600.131.01.

When a user guide is updated, the new or changed text is differentiated with a change bar in the outside margin (this paragraph is an example). If an entire chapter is changed, the change bar is located on the outside margin of the chapter title.

Extensive changes have been made to Chapters 1, 2 and 3 to accommodate the new issue software.

## Table of Contents

User Guide Change Summary.....	i
Table of Contents.....	iii
List of Figures.....	iii
List of Tables.....	iii
How to Use this Guide.....	iv
Assumptions.....	iv
Contents of this User Guide.....	iv
Installation Process Overview.....	iv
Installation Recommendations.....	v
Developing Your Application.....	vi
Conventions.....	vi
Warnings & Cautions.....	vi
Direction.....	vi
Related Publications.....	vi
<b>Chapter 1. INTRODUCTION.....</b>	<b>1</b>
Chapter Objective.....	1
Product Description.....	1
Theory of Operation.....	1
MC20 Menu Structure.....	2
<b>Chapter 2. GETTING STARTED.....</b>	<b>3</b>
Chapter Objectives.....	3
What You Should Have.....	3
Bench Test.....	3
1. Disable the Limit & Stop Inputs.....	4
2. Connect the Drive.....	4
3. Connect the Motor.....	5
4. Connect the AC Power.....	5
5. Match the Drive and Indexer Resolution.....	5
6. Test the System.....	7
<b>Chapter 3. INSTALLATION.....</b>	<b>9</b>
Chapter Objectives.....	9
Installation Precautions.....	9
Mounting Precautions.....	9
Wiring Precautions.....	9
Indexer Mounting.....	10
System Connections.....	10
I/O Connections.....	10
System Functional Tests.....	14
Test the Limit Switches.....	14
Self-test Facility.....	15
<b>Chapter 4. APPLICATION DESIGN.....</b>	<b>17</b>
Chapter Objectives.....	17
Application Considerations.....	17
Motion Profiles.....	17
Mechanical Resonance.....	18
Ringing or Overshoot.....	19
Move Times: Calculated vs Actual.....	19
Positional Accuracy vs. Repeatability.....	19

MC20 Menu Structure.....	20
Configuring the MC20.....	21
Resolution.....	21
Acceleration Rate.....	22
Index Speed.....	23
Jog Speed.....	23
Home Search Speed.....	24
Home Creep Speed.....	24
Limit Deceleration.....	25
Batch Execution Modes.....	25
Auto-home in Power Up.....	27
Saving the Parameters.....	28
Operating Modes.....	28
Jog Axis.....	28
Configuration Mode.....	28
Incremental Indexing.....	29
Absolute Indexing.....	29
Continuous Running.....	30
Batch Indexing.....	30
Returning to the Home Position.....	31
Zeroing the Absolute Position.....	31
Matrix Operation.....	31
Registration Move.....	34
Programming a Sequence of Moves.....	36
<b>Chapter 5. SYSTEM SPECIFICATIONS.....</b>	<b>39</b>
Chapter Objective.....	39
Indexer Specifications.....	39
<b>Chapter 6. MAINTENANCE &amp; TROUBLESHOOTING.....</b>	<b>41</b>
Chapter Objectives.....	41
Routine Maintenance.....	41
Connectors.....	41
Cabling.....	41
Filters.....	41
Troubleshooting.....	41
Problem Isolation.....	41
Reducing Electrical Noise.....	43
Returning the System.....	43
<b>Index.....</b>	<b>45</b>

## List of Figures

Figure 1-1. Typical MC20 Indexer System Functional Block Diagram.....	1
Figure 1-2. Overall MC20 Menu Structure.....	2
Figure 2-1. Bench Test Configuration.....	4
Figure 3-1. MC20 Indexer Dimensions.....	10
Figure 3-2. I/O Connections to the MC20.....	11
Figure 3-3. MC20 Internal Input Circuit and Recommended External Input Circuits.....	12
Figure 3-4. Circuit for Aux Out and Tool Out Outputs.....	13
Figure 4-1. Triangular Profile.....	18
Figure 4-2. Trapezoidal Profile.....	18
Figure 4-3. Overall MC20 Menu Structure.....	20
Figure 4-4. Homing Operation.....	25
Figure 4-5. Batch Execution Mode 1.....	26
Figure 4-6. Batch Execution Mode 2.....	26
Figure 4-7. Batch Execution Mode 3.....	27
Figure 4-8. Matrix Mode Operation.....	32
Figure 4-9. Registration Move Operation Diagram.....	34

## List of Tables

Table 2-1. MC20 Indexer Ship Kit.....	3
Table 2-2. 25-pin Connector Pin Assignments and Colours.....	5
Table 2-3. 15-pin Connector Pin Assignments.....	5
Table 3-1. I/O Connector Pin Assignments.....	11
Table 4-1. Relationship Between Clock Pulse Width and Motor/Drive Resolution.....	22
Table 4-2. Velocity Range Relative to Resolution.....	23
Table 5-1. MC20 Indexer Specifications.....	39

**How to Use this Guide**

This user guide is designed to help you install, develop, and maintain your system. Each chapter begins with a list of specific objectives that should be met after you have read the chapter. This section is intended to help you find and use the information in this user guide.

**Assumptions**

This user guide assumes that you have a fundamental understanding of the following:

- Basic electronics concepts (voltage, switches, current, resistors, etc.)
- Basic motion control concepts (torque, velocity, distance, etc.)

With this basic level of understanding, you will be able to effectively use this user guide to install, develop, and maintain your system.

**Contents of this User Guide**

This user guide contains the following information:

**Chapter 1: Introduction**

This chapter provides a description of the product and a brief account of its specific features.

**Chapter 2: Getting Started**

This chapter contains a detailed list of items you should have received with your MC20 indexer system shipment. It will help you become familiar with the system and ensure that each component functions properly. In this chapter, you will perform a preliminary configuration of the system.

**Chapter 3: Installation**

This chapter provides instructions for you to properly mount the system and make all electrical connections. Upon completion of this chapter, your system should be completely configured, installed, tested, and ready to perform basic operations.

**Chapter 4: Application Design**

Understanding the application considerations and system configuration and operation instructions discussed in this chapter will help you customize the system to meet your application's needs.

**Chapter 5: System Specifications**

This chapter is a quick-reference for system specifications.

**Chapter 6: Maintenance & Trouble-shooting**

This chapter describes recommended system maintenance and troubleshooting procedures. It also provides methods for isolating and resolving hardware problems.

**Installation Process Overview**

To ensure trouble-free operation, you should pay special attention to the following:

- The environment in which the MC20 indexer system will operate
- The system layout and mounting
- The wiring and grounding practices used

These recommendations are intended to help you easily and safely integrate the MC20 indexer system into your equipment. Industrial environments often contain conditions that may adversely affect solid state equipment. Electrical noise or atmospheric contamination may also affect the MC20 indexer system.

**Installation Recommendations**

Before you attempt to install this product, you should complete the following steps:

1. Review this entire user guide. Become familiar with its contents so that you can quickly find the information you need.
2. Develop a basic understanding of all system components, their functions, and interrelationships.
3. Complete the basic system configuration and wiring instructions provided in *Chapter 2, Getting Started*. *This is a preliminary configuration, not a permanent installation, intended to be set up in a bench-top environment.*
4. Perform as many basic functions as you can with the preliminary configuration. You can perform this task only if you have reviewed the entire user guide. You should try to simulate the task(s) that you expect to perform when you permanently install your system. **However, do not attach a load at this time.** This will give you a realistic preview of what to expect from the complete configuration.
5. After you have tested all of the system's functions and used or become familiar with all of the system's features, carefully read *Chapter 3, Installation*.
6. After you have read Chapter 3 and clearly understand what must be done to properly install the system, you should begin the installation process. **Proceed in a linear manner;** do not deviate from the sequence or installation methods provided.
7. Before you begin to customize your system, check all of the system functions and features to ensure that you have completed the installation process correctly.

The successful completion of these steps will prevent subsequent performance problems and allow you to isolate and resolve any potential system difficulties before they affect your system's operation.

**Developing Your Application**

Before you attempt to develop and implement your application, you should consider the following:

- Recognize and clarify your application's requirements. Clearly define what you expect the system to do.
- Follow the guidelines and instructions outlined in this user guide. **Do not skip any steps or procedures.** Proper installation and implementation can be ensured only if all procedures are completed in the proper sequence.

**Conventions**

To help you understand and use this user guide effectively, the conventions used throughout the guide are explained in this section.

**Warnings & Cautions**

Warning and caution notes alert you to possible dangers that may occur if you do not follow instructions correctly. Situations that may cause bodily injury are presented as warnings. Situations that may cause system damage are presented as cautions. Refer to the examples shown below.

**WARNING**

**Do not touch the motor immediately after it has been in use for an extended period of time. The unit will be hot.**

**CAUTION**

**System damage will occur if you power up the system improperly.**

**Direction**

Throughout this user guide, you will find references to clockwise (CW, +) and counter-clockwise (CCW, -) rotation. The direction of rotation is determined while facing the flange-end of the rotary motor.

**Related Publications**

The following publications may be helpful resources:

- *Digiplan Motion Control Catalogue*
- Schram, Peter (editor). *The National Electric Code Handbook (Third Edition)*. Quincy, MA: National Fire Protection Association

## Chapter 1. INTRODUCTION

**Chapter Objective**

The information in this chapter will enable you to understand the product's basic functions & features.

**Product Description**

The MC20 Keypad Indexer is a control input interface for two axes of stepper motors. Commands and their associated parameters are entered on the front panel keypad and displayed on a 2-line, 24-character, LCD display.

The MC20 unit occupies a front panel area 3U (5.25") high x 28HP (5.6") wide. The unit is design to be inserted into a standard 3U Eurorack or mounted on the front or rear panel of a cabinet. All drive and user I/O connectors are located on the unit's back panel.

**Theory of Operation**

The MC20 indexer receives commands from the keypad. The indexer then converts these commands or signals to step pulses and sends them to the drive(s). These step pulses are coupled with a direction signal to control motor velocity, acceleration, direction, and position. The drive converts the step pulses to varied motor currents to control the stepper motor's rotation and angular position. The motor converts electrical pulses into discrete mechanical motion (shaft rotation). Figure 1-1 is a functional block diagram of the system's processes.

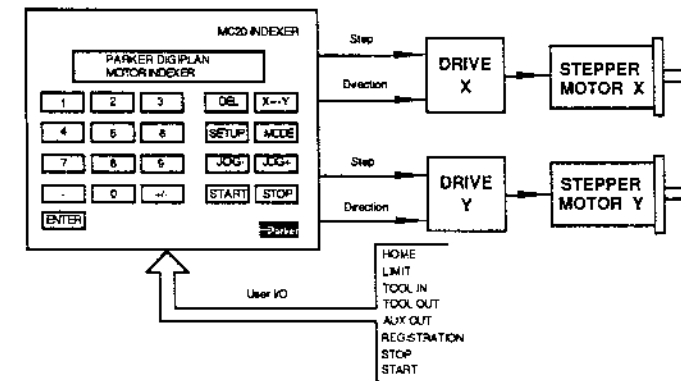

Figure 1-1. Typical MC20 Indexer System Functional Block Diagram

For a detailed description of stepper motor construction and operation, refer to the *Digiplan Motion Control Catalogue*.



**MC20 Menu Structure**

Figure 1-2 is the MC20 menu flowchart. Being familiar with the menu structure will make it easier for you to configure and operate the MC20. As illustrated, you can scan through the menu structure using the Mode or Setup keys.

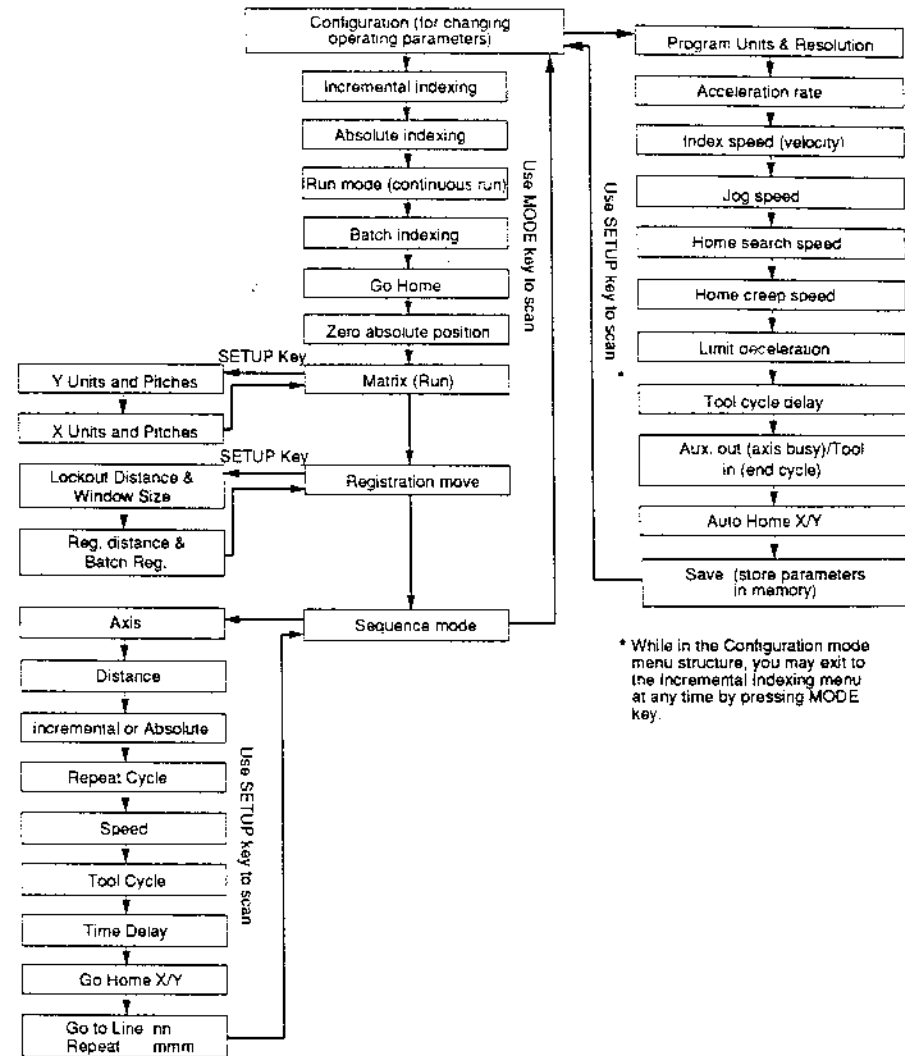

Figure 1-2. Overall MC20 Menu Structure

**Chapter 2. GETTING STARTED**

**Chapter Objectives**

The information in this chapter will enable you to do the following:

- Verify that each component of your system has been delivered safely
- Become familiar with system components and their interrelationships
- Establish a bench test system configuration
- Ensure that each component functions properly

**What You Should Have**

Upon receipt, you should inspect your MC20 indexer system shipment for obvious damage to its shipping container. Report any damage to the shipping company as soon as possible. The manufacturers cannot be held responsible for damage incurred in shipment. The items listed in Table 2-1 should be present and in good condition.

Part Description	Digiplan Part No.
MC20 indexer	MC20 (1392.000)
MC20/RMK (standard):	
- Two 15 pin/25 pin drive cables	1392.078
- Pkg. of screws	4201.001 x 4 4202.001 x 4
- Connector kit	-----
- Power cord (UK)	0404.003
- Power cord (USA)	44-000054-01
MC20/PMK (optional):	
- Bracket	1392.050.01
- Pkg. of screws	4203.022
- Assembly kit	1392.072
MC20 Keypad Indexer User Guide	1600.131.02

Table 2-1. MC20 Indexer Ship Kit

**Bench Test**

This section provides procedures and information to help you configure and test your MC20 indexer system. *This is a temporary bench-top configuration.* Detailed installation instructions are provided in *Chapter 3, Installation.*

Figure 2-1 illustrates the bench test configuration.

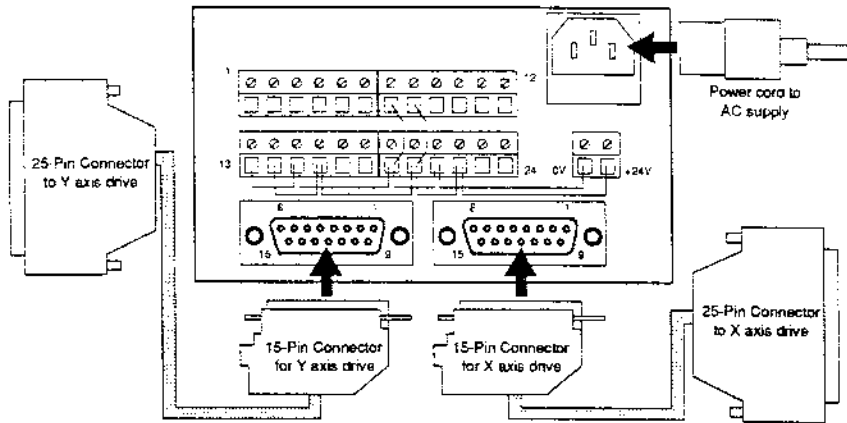

Figure 2-1. Bench Test Configuration

1. Disable the Limit & Stop Inputs

**WARNING**

**Ensure that AC power is disconnected before attempting to perform any wiring.**

For the bench test, the end-of-travel limit inputs and the stop input will not be connected to hard switches. Therefore, to move the motor you must disable these inputs with the following connections (refer to Figure 2-1):

1. Connect the on-board +24V supply to I/O connector pin 22.
2. Connect the on-board 0V supply to I/O connector pin 21.
3. Disable the stop input by jumpering pin 7 to pin 19 and pin 8 to pin 20.
4. Disable the limit inputs by jumpering the following I/O connector pins:
  - 14 to 16, 16 to 20, and 20 to 22
  - 13 to 15, 15 to 19, 19 to 21

2. Connect the Drive

Using the provided 15-pin/25-pin cables, connect the 15-pin connector to the indexer and connect the 25-pin connector to the drive (see Figure 2-1). The 25-pin connector is compatible with Digiplan opto-isolated rack motherboards. If you must remove the 25-pin connector, refer to Table 2-2 for pin assignments and wire colours. Table 2-3 provides pin assignments for the 15-pin drive connectors on the back of the MC20 (pin assignments are identical for both connectors).

3. Connect the Motor

Connect the motor to the drive. Refer to the drive/motor user guide for connection information.

4. Connect the AC Power

The MC20 Indexer can be powered directly from a power outlet supplying any voltage from 86VAC to 264VAC (47 to 63Hz). No input voltage level selection is required. Connect the AC power cable (provided in the ship kit) to the MC20 power connector (see Figure 2-1).

Pin Number	Function	Wire Colour
1	Step +	Green
14	Step -	Yellow
2	Direction +	Blue
15	Direction -	Red
5	Shield	Shield

Table 2-2. 25-pin Connector Pin Assignments and Colours

Pin Number	Function
1	Step +
9	Step -
2	Direction +
10	Direction -

All other pins are not connected, except pins 3, 13, 14, and 15, which are internally connected to logic 0V.

Table 2-3. 15-pin Connector Pin Assignments

5. Match the Drive and Indexer Resolution

For the purpose of this bench test, you must configure the MC20 Indexer's resolution to match the drive's resolution. If the resolutions do not match, the motor will not perform at the programmed acceleration and velocity.

The MC20's resolution is factory-set to 400 steps/rev. If you need to change this setting, use the following procedure:

1. Apply power by plugging the power cable into the AC power source. The green LCD front panel display should illuminate and display the following:

**CAUTION**

**AC power is limited to 264VAC. Higher voltages damage the indexer. The low-voltage limit is 86VAC.**

CONFIGURATION MODE  
PRESS <SETUP> TO SELECT

If nothing appears on the screen, you may need to adjust the LCD viewing angle. This is adjusted via a potentiometer accessible through the left side panel. *After the MC20 is in regular use, you may need to adjust the potentiometer to compensate for viewing angle changes that result from temperature changes.*

*If no keys are pressed for three minutes the LCD back lighting switches off automatically. Pressing any key will restore the back lighting.*

If a different screen is displayed, enter the configuration mode by pressing the Mode key until the Configuration Mode screen appears.

2. Press the Setup key to view the following display:

PROG UNITS: RESOLUTION  
400 X 400

For the purpose of this bench test, set the PROG UNITS equal to the motor/drive resolution. Press the Enter key after you enter the value.

3. Press the Setup key (cursor moves to the resolution field) and enter the resolution (number of steps per revolution). The available values are 200, 400, 800, 1000, 2000, 4000, 5000, 10000, 12800, 21600, 25000, 36000 and 50800 steps/rev. Press the Enter key after you enter the value.
4. Press the Setup key repeatedly until the following is displayed:

SAVE CURRENT SETTINGS  
PRESS <ENTER>

5. Press Enter key to save the Programming Units and Resolution settings in battery-backed memory.
6. If you are using a second axis (drive), press the X---Y key to address the Y axis and repeat steps 3 through 6.
7. Press Setup to get back to Configuration mode.

## 6. Test the System

Use the following procedure to test the functionality of the MC20 indexer system and to verify proper system connections:

1. Make sure the motor shaft is free to rotate.
2. Apply power to the drive.
3. Apply power to the MC20. The green LCD front panel display should illuminate with the following display:

CONFIGURATION MODE  
PRESS <SETUP> TO SELECT

For the purposes of this bench test, we will use the default acceleration and velocity values.

4. Press the Mode key until you see the following display:

INC INDEX <X> 400  
CURRENT POS : 0

5. Enter a distance of 2000 steps on the first line of the display. Press the Enter key after you type in the value.
6. Press the Start key. The motor should move to position 2000. Current Pos should also be updated.

If the motor does not move, refer to *Chapter 6, Maintenance & Troubleshooting*.

If the Current Pos is not updated the +Limit or Stop input has not been wired up correctly

7. If you are using a second axis, press the X---Y key to address the Y axis and repeat steps 4 through 6.

## Chapter 3. INSTALLATION

### Chapter Objectives

The information in this chapter will enable you to do the following:

- Mount all system components properly
- Connect all electrical system inputs and outputs properly
- Test the installed system to verify proper connections and operability

***You must complete all steps in Chapter 2, Getting Started, before proceeding with the steps in this chapter.***

### Installation Precautions

To help ensure personal safety and long life of system components, pay special attention to the following installation precautions.

#### Mounting Precautions

- Consider environmental factors such as atmospheric contamination (oil, moisture, dust, etc.) and excess heat **before** you install and operate your MC20 indexer system. We recommend installing the MC20 in a National Electrical Manufacturers Association (NEMA) approved enclosure when operating in an industrial environment.
- Be sure to provide an air flow adequate to maintain an air temperature between 32°F and 122°F (0°C to 50°C), especially if you mount the MC20 in a cabinet with other equipment.

#### Wiring Precautions

- Never connect or disconnect the drive or other I/O with power applied to the indexer or attached equipment.
- Where cables are likely to be exposed in a machine shop environment, we suggest routing them through a metal conduit.
- Keep low-level signal cables away from those carrying high-level control signals or motor current (separate conduits are recommended).
- Shield all cables to minimize sensitivity to electrical noise from external electrical sources and adjacent wiring.
- All cable shields and other ground connections should be taken to one earth ground point in the control cabinet, and you should leave the remote ends of shields non-terminated. This should eliminate *earth loops* within the system wiring. If such loops exist, currents may circulate in them and cause unreliable or unpredictable performance.

### Indexer Mounting

You can mount the MC20 in three ways, as follows:

- Directly into an existing 3U rack chassis (mount the rack chassis in a standard rack cabinet), using the -RMK screws provided in the ship kit
- Via its front-panel flange, into a cut-out in a cabinet
- Via the -PMK panel-mount brackets (provided in the ship kit), in a NEMA-approved enclosure

Refer to Figure 3-1 for MC20 dimensions and weight.

After you install the MC20, you may need to access the connectors from the back of the unit to complete modifications or repairs. You should consider this when you decide on the most suitable form of mounting.

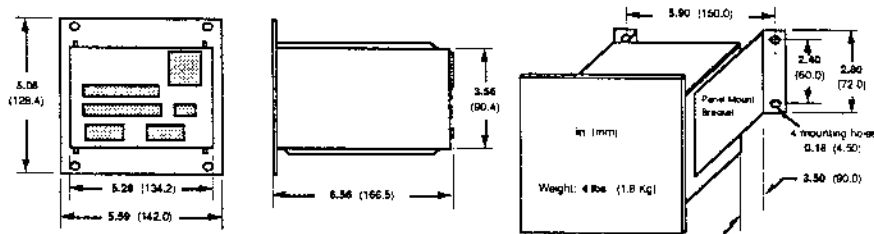

Figure 3-1. MC20 Indexer Dimensions

### System Connections

This section covers procedures for MC20 Indexer I/O connections. Refer to Chapter 2, *Getting Started*, for the drive and AC power connections.

#### WARNING

Ensure that AC power is disconnected before you perform any wiring.

### I/O Connections

I/O connections should be made with a minimum wire size of 18 AWG (0.75mm<sup>2</sup>). Shielded cable should be used for all I/O inputs. Make sure to ground the screen at one end only (see *Wiring Precautions* above).

Table 3-1 identifies the functions of each I/O connector pin (24 pins total). Figure 3-2 illustrates the I/O connections to the MC20.

Pin #	Function
1	Tool Out (collector)
2	Tool Out (emitter)
3	Aux Out (collector)
4	Aux Out (emitter)
5	Tool In -
6	Tool In +
7	Remote Stop -
8	Remote Stop +
9	Aux In 2 (Register. Mark) -
10	Aux In 2 (Register. Mark) +
11	Aux In 1 (Remote Start) -
12	Aux In 1 (Remote Start) +
13	Y CCW Limit -
14	Y CCW Limit +
15	Y CW Limit -
16	Y CW Limit +
17	Y Home -
18	Y Home +
19	X CCW Limit -
20	X CCW Limit +
21	X CW Limit -
22	X CW Limit +
23	X Home -
24	X Home +

Table 3-1. I/O Connector Pin Assignments

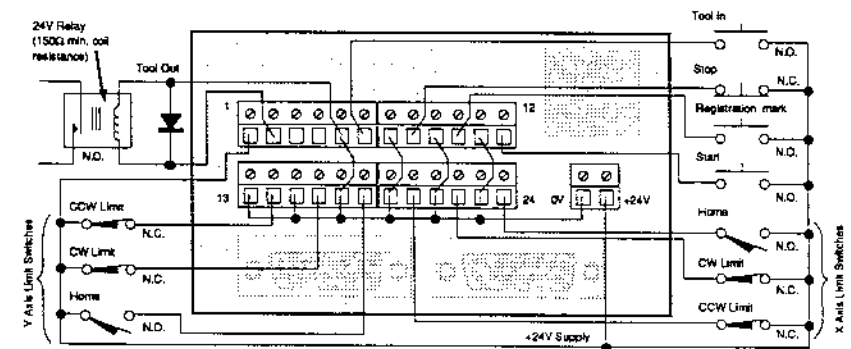

Figure 3-2. I/O Connections to the MC20

Figure 3-3 illustrates the typical MC20 internal input circuit and several recommended external input circuit configurations. Differential line drivers offer the best noise immunity.

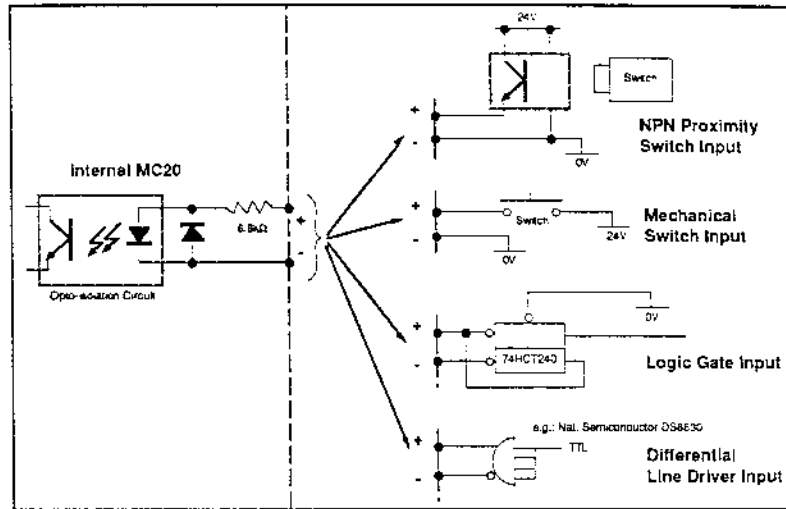

Figure 3-3. MC20 Internal Input Circuit and Recommended External Input Circuits

**Limit Switch Inputs** The limit inputs are intended to be used as end-of-travel emergency stop inputs to prevent the load from travelling beyond the operational travel limits.

You must install normally-closed switches returned to +24V to ensure that motion is stopped if the limit is *tripped* (opened) or if the limit connection is broken. Refer to Figure 3-2 for limit input connections. When the load trips the limit switch, the axis decelerates to a stop at the limit deceleration rate (see *Configuring the MC20* in Chapter 4). **These limit inputs must be connected to +24V if limit switches are not required (see *Disable The Limit & Stop Inputs* in Chapter 2).**

**Home Switch Input** The home input is used to establish the home position (discussed in Chapter 4). Connect the home switch to the +24V supply via a normally-open switch (see Figure 3-2). The input operates when the switch is closed to +24V, drawing a current of 20mA. Switch debounce is incorporated.

**Remote Start Input** As an alternative to the keypad Start button, you can wire a remote normally-open start switch to a +24V supply (see Figure 3-2). You can initiate the current programmed move by closing the switch.

**Remote Stop Input** As an alternative to the keypad Stop button, you can wire a remote normally-closed stop switch to the +24V supply (see Figure 3-2). When the stop input switch is opened, the axis currently in motion decelerates to a stop at the programmed limit deceleration rate. **This input must be connected to +24V if a stop switch is not required (see *Disable The Limit & Stop Inputs* in Chapter 2).**

**Registration Mark Input** Aux In 2 is the Registration Mark input. It is optically isolated and requires +12 to +24V at pin 10 to operate, with pin 9 connected to 0V (see Figure 3-2). The registration pulse for registration moves is applied to this input. The input is activated by the positive edge of a +12 to +24V pulse.

For an explanation of how this input is used, refer to the section entitled *Registration Move* in Chapter 4.

**Tool Out and Tool In** The Tool Out output switches on (high) to start a remote tool operation at the end of a move (when the axis is not moving). Its output can drive 300mA from a +24V source to energize a relay (to start a tool cycle, for example). The collector and the emitter of the output transistor are connected via I/O connector pins 1 and 2, respectively (refer to Figure 3-2). The voltage and current ratings of the output devices are limited to 24V and 300mA, respectively.

The Tool In input is used as an optional trigger input to start the next move in a series of successive batch moves. It is an opto-isolated input requiring +12 to +24V to drive it. The Tool In input is connected via I/O connector pins 5 and 6 (refer to the input connections in Figure 3-2).

For a detailed explanation of the batch moves and the uses of Tool In and Tool Out, refer to the section entitled *Batch Execution Modes* in Chapter 4.

Figure 3-4 illustrates the output circuit applicable to Tool Out and Aux Out.

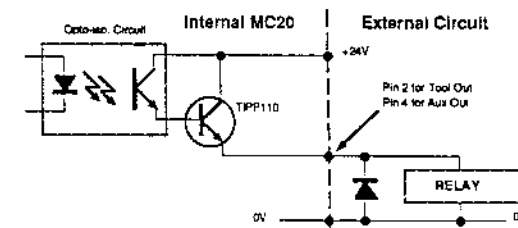

Figure 3-4. Circuit for Aux Out and Tool Out Outputs



**Auxiliary Output** The Auxiliary Output can be configured to operate in two ways:

- 1) To turn on when an axis is moving
- 2) To turn on when an axis is busy, i.e. in motion or performing a tool cycle

In the latter case the output will turn on when motion starts and turn off when the tool cycle has been completed at the end of the move. These options give added flexibility when the MC20 is interfaced with an external controller such as a PLC

The Auxiliary Output collector (pin 3) and emitter (pin 4) of its output transistor are available. This allows flexibility in the arrangement of the interfacing circuit within the limitations that the voltage and current ratings (24V and 300mA, respectively) of the output devices must not be exceeded. Refer to Figure 3-4 for the output circuit illustration.

### System Functional Tests

If you performed all the system configuration procedures in Chapter 2 and Chapter 3, your system hardware should be fully configured and ready to perform basic operations.

Before you proceed to Chapter 4 to perform the final system configuration, return to Chapter 2 and repeat the functional test in the section entitled 6. *Test The System*.

If you connected end-of-travel limit switches or remote start and stop switches, use the following procedures to test for proper operation. **Do not perform these tests with the motor coupled to the load.**

### Test the Limit Switches

In the following test, if you have connected remote Start and Stop switches, substitute them instead for the Start and Stop keys.

1. Make sure the limit switches are wired properly (see Figure 3-2).
2. Apply power to the MC20 and the drives.
3. Press the Mode key to view the following display:

```
CONFIGURATION MODE
PRESS <SETUP> TO SELECT
```

4. Press the Setup key repeatedly until you see the following display:

```
INDEX SPEED          <X>
(revs/s) :   nnn.n
```

5. Type in an index speed (velocity) of 0.5 for the X axis and press Enter.
6. Press the X---Y key and type in an index speed (velocity) of 0.5 for the Y axis and press Enter.
7. Press the Setup key to view the following display:

```
SAVE CURRENT SETTINGS
PRESS <ENTER>
```

8. Press the Enter key to save the Index Speed settings in memory.
9. Press the Mode key to view the following display:

```
RUN MODE <Y>  +direction
CURRENT POS : +/-nnnnnnnn
```

10. Press the Start key (or close the remote start switch). The Y axis motor should rotate CW continuously at a velocity of 0.5 revs per second (rps).
11. While the shaft is rotating, open the CW limit switch. The motor should stop immediately.  
  
If the shaft does not stop, press the Stop key (or open the remote stop switch) and check the CW and CCW input connections against Figure 3-2.
12. Press the X---Y key to address the X axis and repeat steps 10 and 11.

### Self-test Facility

When the indexer is in Configuration Mode, pressing the 7, 8 and 9 keys simultaneously causes the MC20 to enter a self-test mode. In this mode, it displays the state of all its inputs:

```
X HOME          TOOL IN
nnnnnnnnnn
```

$n = 1$  or 0 depending on the state of each input. The inputs are displayed as follows (bit 1 is on the left):

Bit 1	X Home
Bit 2	X Limit +
Bit 3	X Limit -
Bit 4	Y Home
Bit 5	Y Limit +
Bit 6	Y Limit -
Bit 7	Aux In 1
Bit 8	Aux In 2
Bit 9	Stop
Bit 10	Tool In

This facility can be used to check that the inputs are connected correctly.

A check of the outputs is also provided by pulsing them every second in a binary count format:

AUX OUT	TOOL OUT
0	0
0	1
1	0
1	1

Press the Stop key to exit this mode.

## Chapter 4. APPLICATION DESIGN

### Chapter Objectives

The information in this chapter will enable you to do the following:

- Recognize and understand important considerations that must be addressed before you implement your application
- Understand the system's operating parameters
- Customize the system to meet your requirements

### Application Considerations

Successful application of a rotary motor system requires careful consideration of the following important points:

- Motion Profiles
- Mechanical Resonance
- Ringing or Overshoot
- Move Times (calculated vs. actual)
- Positional Accuracy and Repeatability

### Motion Profiles

A motion profile represents the velocity of the motor during a period of time in which the motor changes position. The type of motion profile that you need depends upon the motion control requirement that you specify. The basic types of motion profiles are described below.

### Triangular and Trapezoidal Profiles

For constant acceleration indexing systems, velocity, acceleration, and distance parameters are defined before the system can execute a preset move. The value of these parameters determines the type of motion profile as either triangular or trapezoidal. A triangular profile results when the velocity and acceleration are set such that the defined velocity is not attained before the motor travels half of the specified distance. This results from either a relatively low acceleration, a relatively high velocity, or both. For example, if you set the acceleration at 20 revs/sec/sec ( $rps^2$ ), velocity at 2 revs/sec (rps), and distance at 200 steps (1/2 revolution at a resolution of 400 steps/rev) – a triangular motion profile is the result. This occurs because the motor shaft will have travelled half of the defined distance before it reached the defined velocity of 2 rps. The motion profile for this move is shown in Figure 4-1.



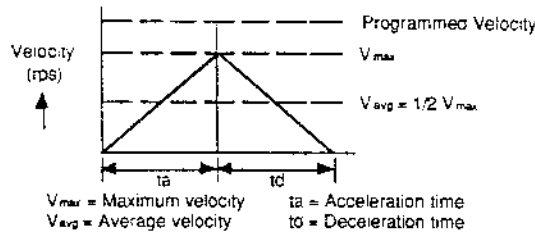

Figure 4-1. Triangular Profile

A trapezoidal move profile results when the defined velocity is attained before the motor shaft has moved half of the specified distance. A trapezoidal move may occur if you specify a low velocity with a high acceleration or a long distance. For example, if you set the acceleration at 10 rps<sup>2</sup>, the velocity at 6 rps, and the distance at 4000 steps (10 revolutions at 400 steps/rev), the resulting motion profile will resemble the profile shown in Figure 4-2.

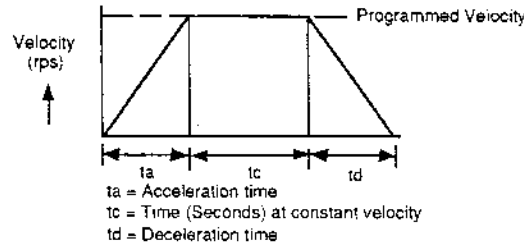

Figure 4-2. Trapezoidal Profile

**Mechanical Resonance**

Resonance exists in all stepper motors. Typically, when operated at 200 or 400 steps/rev, the motor's performance is greatly reduced and may stall at speeds below 250 full-steps/sec. Using a drive with micro-stepping capability will reduce resonance and allow smoother operation at low speeds.

It is sometimes useful to add inertia to the motor shaft to reduce resonance effects. In extreme cases, you may need a viscous damper to eliminate the problem. One of the manufacturers of viscous dampers is listed below:

Ferrofluidics Corporation  
 40 Simon Street  
 Nashua, NH 03061  
 (603) 883-9800

**Ringing or Overshoot**

The motor's springiness, along with its mass, form an underdamped resonant system that oscillates, or *rings*, at the end of a move. Ringing at the end of a move prolongs settling time. The actual settling time of a system depends on the motor's stiffness, the mass of the load, and any frictional forces that may be present. By adding a little friction, you can decrease the motor's settling time.

**Move Times: Calculated vs Actual**

You can calculate the time it takes to complete a move by using the acceleration, velocity, and distance values that you define. However, you should not assume that this value is the exact move time. Indexer calculation delay and motor settling time make the actual move time longer.

**Positional Accuracy vs. Repeatability**

In rotary positioning systems, some applications require high absolute accuracy. Others require repeatability. You should clearly define and distinguish these two concepts when you address the issue of system performance.

If the positioning system is taken to a fixed place and the coordinates of that point are recorded, the only concern is how well the system repeats when you command it to go back to the same point. For many systems, what is meant by accuracy is really repeatability. Repeatability measures how accurately you can repeat moves to the same position.

Accuracy, on the other hand, is the error in finding a random position. For example, suppose the job is to measure the size of an object. The size of the object is determined by moving the positioning system to a point on the object and using the move distance required to get there as the measurement value. In this situation, basic system accuracy is important. The system accuracy must be better than the tolerance on the measurement that is desired.

The accuracy of the positioning system is affected by the following errors:

- **Uni-directional Repeatability.** The error measured by repeated moves to the same point from different distances in the same direction.
- **Hysteresis.** The backlash of the motor when it changes direction (caused by magnetic non-linearity)

For more information on accuracy and repeatability, consult the technical data section of the *Digiplan Motion Control Catalogue*.

**MC20 Menu Structure**

Figure 4-3 is the MC20 menu flowchart. Being familiar with the menu structure will make it easier for you to configure and operate the MC20.

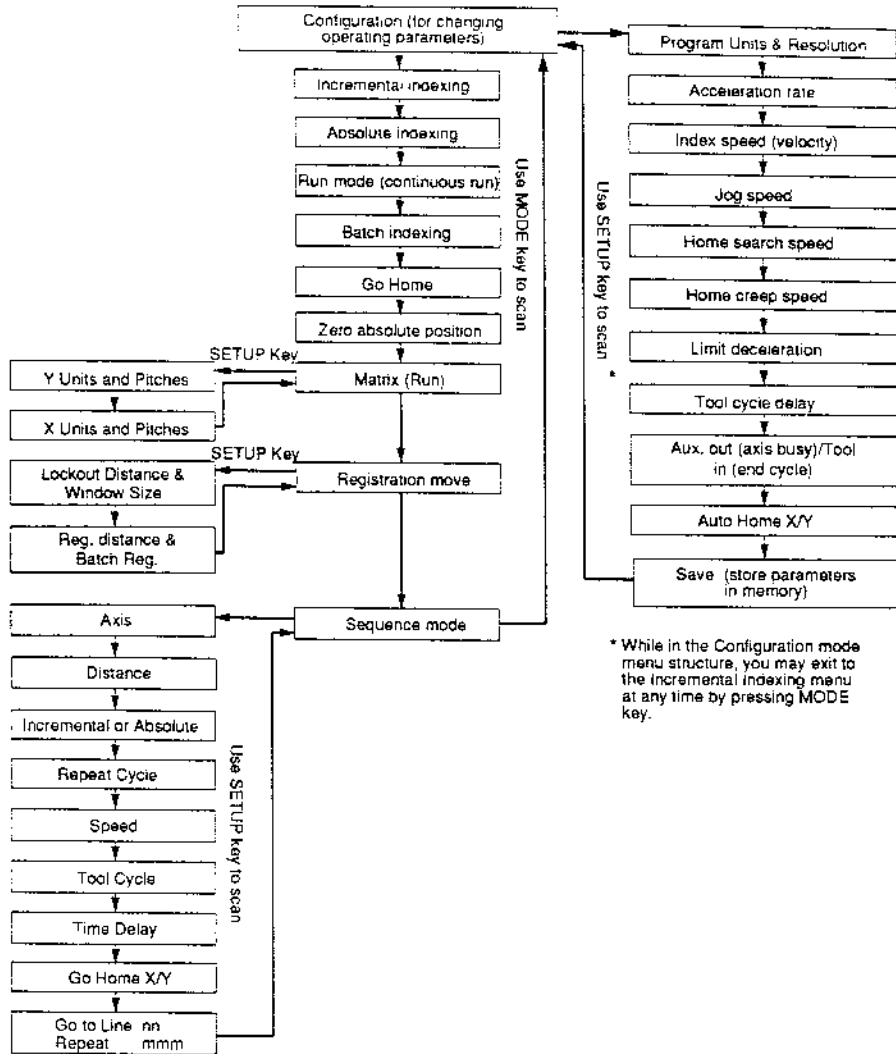

Figure 4-3. Overall MC20 Menu Structure

\* While in the Configuration mode menu structure, you may exit to the incremental indexing menu at any time by pressing MODE key.

**Configuring the MC20**

Using the keypad, you can tailor the MC20 operating parameters to your application's requirements.

The MC20 must be in the *configuration mode* to change the operating parameters. To enter the configuration mode, press the Mode key until the following is displayed:

CONFIGURATION MODE  
PRESS <SETUP> TO SELECT

Now you can select the operating parameters using the Setup key. Figure 4-3 above shows the menu structure of the ten operating parameter menus in the configuration mode.

To reset the software to the original factory default settings, simply press the Del and X--Y keys simultaneously.

Whenever the <X > or <Y > specifier appears on the LCD display, you can use the X--Y key to select the axis being configured.

**You must press the Enter key after you enter any new variables. When you finish changing all the parameters, save the settings at the Save menu.**

If other values are not entered for the variable parameters, the default values will be automatically assigned to them by the MC20 software.

**Resolution**

1. Press the Setup key to view the following display:

PROG UNITS: RESOLUTION  
N X nnnn

2. For normal 1:1 scaling, set the PROG UNITS (N) value equal to the RESOLUTION value (nnnn). The available values are 200, 400, 800, 1000, 2000, 4000, 5000, 10000, 12800, 21600, 25000, 36000 and 50800. In normal scaling, the distance parameter entered equals the number of motor steps the motor will move.

If you wish to use the MC20's scaling function, you must enter a value that will produce the desired user resolution.

**Example** You are using a 2,000 step/rev motor/drive system with a 5-pitch (5 revs = 1 inch) lead-screw, and you want to program the MC20 in 0.1-inch increments. 1 inch of linear movement = 10,000 (2,000 x 5) motor steps. Therefore, 0.1 inches of movement = 1,000 motor steps. There are 2,000 motor steps/rev, so you require 2 (2,000 ÷ 1,000) user steps/rev. To program in 0.1-inch increments then, the Prog Units (N) value must be 2.  
 1 rev = 2,000 motor steps = 2 user steps  
 and 1 user step = 1,000 motor steps = 0.1 inch.

Now, if you enter a value of 100 in the incremental index menu and press the start key, the motor will move 10 (100 x 0.1) inches.

**The PROG UNITS value must be a whole number; otherwise, the exact programmed distance will not be achieved since the motor can move only a whole number of steps.**

3. Press the Setup key (cursor moves to the resolution value area).
4. Enter the required motor steps per revolution in the nnnn field. The available values are provided in step 2 above. The default value is 400. Then press the Enter key.

Note: As motor resolution increases the clock pulse width decreases as shown in Table 4-1.

Clock Pulse Width (µS)	Motor Resolution (Steps)
5.2	200, 400, 800
4.9	1000
2.4	2000
1.2	4000
0.9	5000
0.6	10000 and above

Table 4-1. Relationship Between Clock Pulse Width and Motor/Drive Resolution

**CAUTION**

Changing the resolution also changes the programmed acceleration, velocity, jog speed, home search speed, home creep speed, and limit deceleration.

**Acceleration Rate**

1. Press the Setup key to view the following display:

ACCELERATION RATE <X>  
(revs/s/s) : nnnn

**Index Speed**

2. Enter the rate in revs/sec/sec (rps<sup>2</sup>) and press the Enter key.

The minimum acceleration rate depends on the resolution setting - it is equivalent to 244 steps/sec<sup>2</sup>. This corresponds to 1.22 rps<sup>2</sup> at 200 steps/rev, falling to 0.0048 rps<sup>2</sup> at 50,800 steps/rev. The maximum acceleration rate is 5000 rps<sup>2</sup>.

For an explanation of the acceleration rate relative to the velocity and the resulting motion profile, refer to the section titled *Motion Profiles* near the beginning of this chapter.

This is the speed (velocity) measured in revolutions per second (rps) used in the RUN mode and in all indexing moves. The motor may not reach this speed during a short move, in which case it will follow a triangular profile (see the *Motion Profiles* section).

1. Press the Setup key to view the following display:

INDEX SPEED <X>  
(revs/s) : nnn.n

2. Enter the index speed (velocity) in revs/sec (rps) and press the Enter key. The maximum velocity depends on the resolution setting (see Table 4-2 below). The minimum velocity is 0.002 rps.

Resolution (steps/rev)	Max. Velocity (rps)
5000 & below	100
10000	81
12800	64
21600	37
25000	32
36000	22
50800	16

Table 4-2. Velocity Range Relative to Resolution

For an explanation of the velocity relative to the acceleration and the resulting motion profile, refer to the section titled *Motion Profiles* near the beginning of this chapter.

**Jog Speed**

1. Press the Setup key to view the following display:

JOG SPEED <X>  
(revs/s) : nn.n

2. Enter the speed (velocity) required for the selected axis when the Jog key is pressed. Then press the Enter key. The jog speed value must be within the range 0.1 - 10.0 rps. The default jog speed is dependent on the resolution.

Home Search Speed

1. Press the Setup key to view the following display:

```

HOME SEARCH SPEED <X>
(revs/s) : +/-nnn.n
    
```

Figure 4-4 below shows the positive and negative homing functions. The axis moves at the home search speed when seeking the home position, except for the final positioning move (determined by the Home Creep Speed).

2. Enter the required home search speed within the range 0.1 - 100.0 rps and press the Enter key. Then select the desired direction by pressing the ± key as required. The default value is dependent on the resolution. The sign indicates the direction of the initial home search move (+ corresponds to CW, - corresponds to CCW).

Home Creep Speed

1. Press the Setup key to view the following display:

```

HOME CREEP SPEED <X>
(revs/s) : nn.n
    
```

The final positioning move of the homing function is carried out at slower speed than when searching for the home position (see Figure 4-4). This is called the *home creep speed*.

2. Enter the required home creep speed within the range 0.1 - 10.0 rps and press the Enter key. The default value is dependent on the resolution.

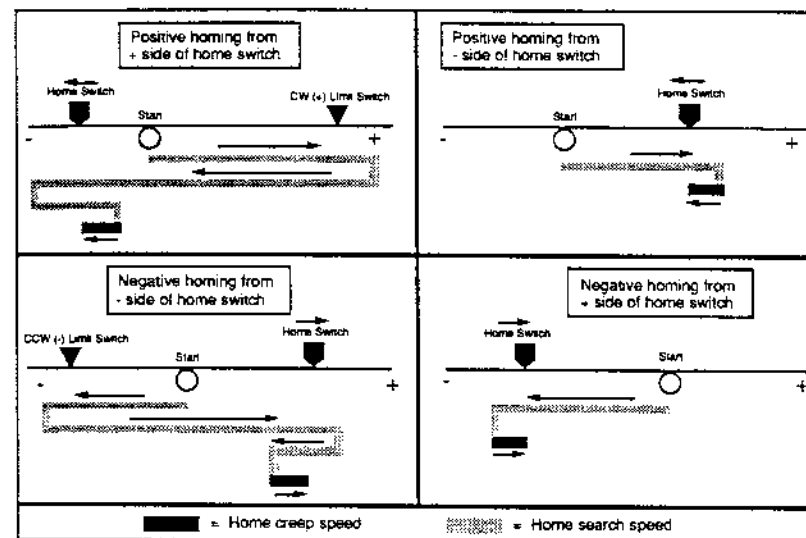

Figure 4-4. Homing Operation

Limit Deceleration

1. Press the Setup key to view the following display:

```

LIMIT DECELERATION <X>
(revs/s/s) : nnnn
    
```

If a limit switch is encountered during axis travel, the axis will decelerate to a stop at the *limit deceleration rate*.

2. Enter the deceleration rate within the range 5 - 5000 rps<sup>2</sup> and press the Enter key. The default value is dependent on the resolution. The value entered here will also be the deceleration rate when the Stop input is activated.

Batch Execution Modes

The MC20 can execute move batches (i.e., Batch Indexing, Matrices, and Batch Registration moves) in one of four different modes, defined by the settings of Tool Cycle Delay and Tool In.

- Mode 1: Tool Cycle Delay = zero; Tool In = 1
- Mode 2: Tool Cycle Delay > zero; Tool In = 0
- Mode 3: Tool Cycle Delay > zero; Tool In = 1
- Mode 4: Tool Cycle Delay = zero; Tool In = 0

In Modes 1 through 3, at the end of the indexer move the Tool Out signal is set high (active state) and it remains in the active state until conditions dependent upon the mode are met. This is known as a **Tool Cycle**. Thus, you can use the Tool Out output to signal a peripheral device that the axis is no longer moving.

**Mode 1** If the Tool Cycle Delay is set to zero and the Tool In option is set to 1, Tool Out remains high until the Tool In signal goes high (switch is closed to +24V). Tool Out then goes low and the next move is started (see Figure 4-5).

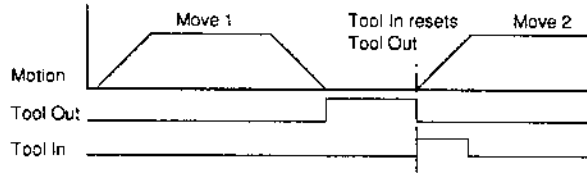

Figure 4-5. Batch Execution Mode 1

**Mode 2** If the Tool Cycle Delay is set greater than zero and the Tool In option is set to 0, Tool Out remains high (delaying the next move) until the Tool Cycle Delay has elapsed. It is then set low and the next move is started (see Figure 4-6).

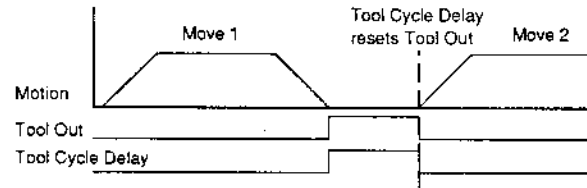

Figure 4-6. Batch Execution Mode 2

**Mode 3** If the Tool Cycle Delay is set greater than zero and the Tool In option is set to 1, Tool Out remains high until after the Tool Cycle Delay has elapsed. Then, when the Tool In signal goes high (switch is closed to +24V), the Tool Out signal is set low and the next move is started (see Figure 4-7). If Tool In occurs during the Tool Cycle Delay, Tool Out is set low after the Tool Cycle Delay.

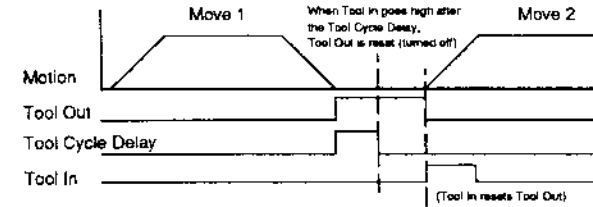

Figure 4-7. Batch Execution Mode 3

**Mode 4** If the Tool Cycle Delay is set to zero and the Tool In option is set to 0, the next move in the batch is automatically executed without delay. This is the default mode.

Set up the required mode using the Tool Cycle Delay and Tool In displays as described below.

- Tool Cycle Delay**
1. Press the Setup key to view the following display:

```

TOOL CYCLE DELAY  <X>
(mS) : nnnnnnnn
    
```

2. Enter the tool cycle delay (in milliseconds) within the range 2 - 9,999,998 and press the Enter key. The default value is 0. The MC20 rounds off this number to the next lowest even number.

- Aux Out/Tool In**
1. Press the Setup key to view the following display:

```

AUX-OUT (axis busy) : X  0
TOOL-IN (end cycle) : X  0
    
```

2. Enter either 0 or 1 for each parameter, and press the Enter key. The default value in both cases is 0. Move the cursor from one setting to the other with the Setup key.

- AUX-OUT = 1: Active while axis is busy (i.e. moving or performing a tool cycle).
- AUX-OUT = 0: Active while axis is moving
- TOOL-IN = 1: Next move delayed until Tool In signal goes high
- TOOL-IN = 0: Next move not dependent on Tool In signal

**Auto-home In Power Up**

1. Press the Setup key to view the following display:

```

AUTO HOME:  X axis: 0
             Y axis: 0
    
```

- Enter either 0 or 1 for each parameter and press the Enter key. The default value in both cases is 0. Move the cursor from one setting to the other with the Setup key.

Entering a 1 will cause the unit to go home when it next powers up and set its current position to the value set by the Go Home screen (provided the settings are saved).

**Note:** The X axis will always Go Home first if both axes are selected.

#### Saving the Parameters

- Press the Setup key to view the following display:

```
SAVE CURRENT SETTINGS
PRESS <ENTER>
```

- Press Enter if you want all of the values entered during configuration (along with other values such as distance of incremental index, home offsets, and batch move variables) to be stored in backup RAM.

These values are restored at power-up (if a checksum test passes). If the checksum does not pass, a message will appear on the display and the original factory settings are used.

#### CAUTION

**All parameters, not just operating parameters, must be saved. For instance, Matrix parameters must be saved or they will be lost if you cycle power.**

#### Operating Modes

The MC20's operating modes are selected using the Mode key. Refer to Figure 4-3 for the menu structure flow chart of the twelve operating modes described in detail below.

**All values entered in the operating modes menus must be saved at the SAVE menu located in the CONFIGURATION menu structure (see *Saving the Parameters* above).**

#### Jog Axis

The Jog keys are active in any mode that the Start key is valid. The motor moves approximately one pulse (step) every time a Jog key is pressed. If a Jog key is held down for more than half a second, the motor runs continuously at the programmed jog speed (set in the Configuration Mode).

#### Incremental indexing

*Incremental indexing* is moving the motor a specified distance (in motor steps) in a specified direction from the current position.

Use the following procedure to carry out an incremental index operation:

- Access this mode by pressing the Mode key repeatedly until you see the following display:

```
INC INDEX <X>  +/-nnnnnnnn
CURRENT POS :  +/-nnnnnnnn
```

- Enter the distance to move on the first line of the display and press the Enter key. Then enter the direction of the move using the  $\pm$  key. The range of values is  $\pm 16,777,215$ . The default value is 400.
- Press the Start key or close the remote start switch to start the move.

The second line of the display is updated at the end of every move to show the current absolute position.

#### Absolute Indexing

*Absolute indexing* is moving the motor to an absolute position relative to the *absolute zero position*.

The absolute zero position must be set (in the Zero Absolute Position Mode) as the zero position offset from home or as the power up zero position before an absolute indexing move.

A common use of this mode is to move the load to the absolute zero position to begin a batch move.

Use the following procedure to carry out an absolute index operation:

- Press the Mode key to view the following display:

```
ZERO ABS POSITION  <X>
PRESS <ENTER>
```

- Set the current position to absolute zero by pressing the Enter key.
- Press the Mode key to view the following display:

```
ABS INDEX <X>  +/-nnnnnnnn
CURRENT POS :  +/-nnnnnnnn
```



- Enter the position to which the motor should move and press the Enter key. The range of values is +/-16,777,215 and the default value is 400. The second line of the display shows the current position.
- When you press the Start key or close the remote start switch, the axis moves to the specified position.

#### Continuous Running

To run the motor continuously, use the following procedure:

- Press the Mode key to view the following display:

```

RUN MODE <X>  +direction
CURRENT POS : +/-nnnnnnnn
  
```

- Press the +/- key to select the direction of the move.
- Press the Start key or close the remote start switch to initiate the move. The motor will accelerate to the index speed and continue at that speed until the Stop key is pressed, a limit switch is operated, or the remote stop switch is opened.

#### Batch Indexing

The batch index operation is an incremental move of a specified distance repeated a specified number of times. You can set up a time delay between moves (refer to the TOOL CYCLE DELAY menu in the Configuration Mode).

Use the following procedure to carry out a batch index operation:

- Return to the incremental index menu to set the distance and direction to be moved (see the appropriate section above).
- Use the Mode key to access the following display:

```

BATCH INDX <X> +/-nnnnnn * nn
CURRENT POS : +/-nnnnnnnn
  
```

- Enter the value, within the range 0 - 99, for the number of times to repeat the index (\*nn) and press Enter. The default value for \*nn is 1. The value will be decremented at the end of each move. If \*nn is set to zero, the operation will be repeated indefinitely.
- Press the Start key (or close the remote start switch) to start the batch index. Successive moves in the batch are executed in the method determined by the current batch execution mode setting (see *Batch Execution Modes* above).

#### Returning to the Home Position

The homing function, home search speed, and home creep speed are described in a previous section entitled *Configuring the MC20*.

Use the following procedure to perform a homing operation:

- Select the following display using the Mode key:

```

GO HOME <X>
OFFSET +/-nnnnnnnn
  
```

- When the homing process is complete, the internal absolute counter is set to zero (the default value) or to an offset absolute location entered in the second line of the display above. **Be sure to enter the offset value before the move is started.**
- Press the Start key or close the remote start switch to start the move.

#### Zeroing the Absolute Position

To set the current position as the absolute zero position, use the Mode key to select the following display:

```

ZERO ABS POSITION <X>
PRESS <ENTER>
  
```

Then press the Enter key. The Position Zeroed message will appear.

#### Matrix Operation

The Matrix Mode produces alternate X and Y motion in the following process (*both axes start at the absolute zero position*):

- The X axis moves the distance/direction defined in the incremental index menu (no tool cycle at end of move).

2. The Y axis moves the distance/direction defined in the incremental index menu (no tool cycle at end of move).
3. A tool cycle is performed at the first matrix position.
4. Both axes then perform a matrix of moves as defined in the Matrix setup screens (tool cycles are executed after each successive move). After each Y axis move, the X axis move is executed in the opposite direction.
5. The X axis returns to the absolute zero position (no tool cycle at end of move).
6. The Y axis returns to the absolute zero position (no tool cycle at end of move).

For example, on an X-Y positioning stage, the following parameters result in the pattern illustrated in Figure 4-8.

Y Axis incremental index = 400    Y units = 800    Y pitch = 3  
 X Axis incremental index = 800    X units = 400    X pitch = 4

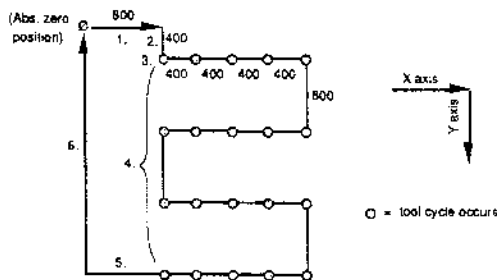

Figure 4-8. Matrix Mode Operation

The length of the tool cycle is determined by the Tool Cycle Delay setting; if no tool operation is required, this will provide a fixed time delay between moves. Alternatively the next move can be initiated by the Tool In function.

The parameters for matrix operation are set up as follows:

1. Set up the incremental indexing parameters (see *Incremental Indexing* above) which determine the position of the first matrix point relative to absolute zero.
2. Zero the absolute position (see *Zeroing the Absolute Position* above). **Make sure both axes are in the desired starting position first.**

3. Press the Mode key until the following display is shown:

```

  MATRIX <X/Y>
    n  BY  n
  
```

4. Press Setup to view the following display:

```

  Y UNITS      :      PITCHES
  +/-nnnnnn   :      nn
  
```

5. Enter the Y distance to move and press the Enter key. Then enter the direction of the move using the  $\pm$  key. The default value is 400.
6. Press Setup again and enter the number of times (PITCHES) the move is to be executed (nn) within the range 0 - 99 and press Enter. The default value is 1. Entering zero will result in an infinite number of executions.
7. Press Setup again to view the following display:

```

  X UNITS      :      PITCHES
  +/-nnnnnn   :      nn
  
```

8. Enter the X distance to move and press the Enter key. Then enter the direction of the move using the  $\pm$  key. The default value is 400.
9. Press Setup again and enter the number of times the move is to be executed within the range 1 - 99 and press Enter. The default value is 1. An infinite number of X pitches is invalid.
10. Press the Setup key to return to Step 3.

The number of executions (PITCHES) defined in the previous two screens are displayed in the n BY n field. For instance, if the X axis pitch is 3 and the Y axis pitch is 12, the n BY n field would show 3 BY 12.

11. Press the Start key or close the remote start switch to commence the operation. The numbers n BY n will be decremented as each move is completed.

Successive moves in the batch are executed in the method determined by the current batch execution mode setting (see *Batch Execution Modes* above).



If the matrix is stopped in progress (i.e., by limit, Stop key, or stop switch), and you press the Start key, the matrix will begin at the very beginning of the cycle. Be sure to use the Absolute Index Mode to move the axes back to the absolute zero position; otherwise, the new matrix will start wherever the axes were at the time the last matrix was stopped.

Registration Move

This is a move of a specified distance initiated when a registration signal is seen at the Aux In 2 (Reg. Mark) input (see I/O Connections in Chapter 3). The tool cycle is complete at the end of the registration move, and the move can be programmed to be repeated a specified number of times. The direction and distance in the Incremental Index menu determines the direction of the registration move, as well as the distance of the original move if no registration mark signal is detected within the window region (refer to Path if no mark is encountered in Figure 4-9).

Figure 4-9 shows registration mode operation.

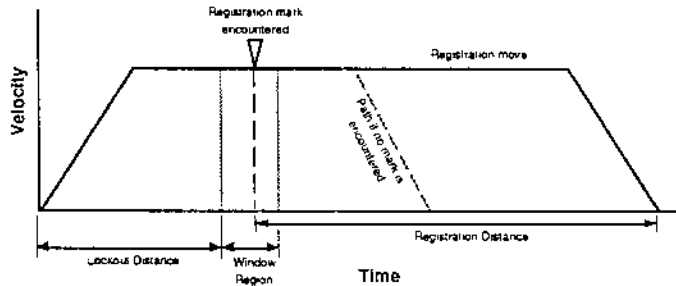

Figure 4-9. Registration Move Operation Diagram

Use the following procedure to set up a registration move operation:

1. Establish the incremental indexing distance and direction under the INCREMENTAL INDEX menu (see above). This direction setting determines the direction of the registration move. If the registration mark is not detected, the motor will move the distance set at the incremental indexing menu.
2. Press the Mode key to access the following display:

```
REGISTRATION MOVE <X> n
CURRENT POS : +/-nnnnnnnn
```

3. Press the Setup key to view the following display:

```
LOCKOUT DISTANCE nnnnnn
WINDOW SIZE <X> nnnnn
```

The lockout distance is the distance from the start of the move to the beginning of the window region. The registration move is started only if the registration mark is detected within the window region.

4. Enter the lockout distance within the range 0 - 16,777,215 and press the Enter key. The default value is 0.
5. Press Setup again and enter the window size within the range 1 - 99999 (default value is 0) and press the Enter key.

The sum of the LOCKOUT DISTANCE and WINDOW SIZE must be equal to or less than the move distance (incremental index distance) travelled if no mark was detected.

6. Press the Setup key to view the following display:

```
REG DISTANCE nnnnnnnn
BATCH REG <X> nn
```

7. Enter the registration distance within the range 0 - 16,777,215 (default value is 0) and press the Enter key.
8. Press Setup again and enter the batch registration (the number of times to repeat the registration move) within the range 1 - 99 and press the Enter key. A value of zero produces an infinite repeat cycle. The default value is 1.
9. To carry out a move using the parameters set up in Registration Mode, press the Setup key to view the following display:

```
REGISTRATION MOVE <X> n
CURRENT POS : +/-nnnnnnnn
```

The number of times the move will be made is displayed on the first line (n) and the current position is displayed on the second line. This move is always in incremental distance.

10. Press the Start key or close the remote start switch to commence the operation.

Successive moves in the batch are executed in the method determined by the current batch execution mode setting (see Batch Execution Modes above).

### Programming a Sequence of Moves

The Sequence Mode allows the MC20 to perform a complete sequence of moves in both X and Y axes. A maximum of 25 different moves may be specified, and each move can be repeated up to 255 times. The system can be requested to 'Go Home' on either or both axes when all moves are completed, and there is provision for looping back to any specified line from the end of the sequence.

Use the Mode key to step through to the Sequence Mode screen:

```
SEQUENCE MODE busy
LINE: nn COUNT: mmm
```

When a sequence is running, nn represents the line number currently being executed and mmm is the number of repeats left for that line.

When this screen is displayed you can either press:

Setup - to start changing the sequence information  
Start - to run the sequence

When the sequence is running the word 'busy' appears on the screen in the position shown above.

The Aux Out output is always on when a sequence is being performed.

The sequence involves a maximum of 25 different moves, each move being programmed in a different sequence line. In each line you can specify:

Distance;  
Direction;  
Incremental or absolute indexing;  
Number of repeats;  
Velocity;  
Axis (X or Y);  
Tool cycle on or off;  
Time delay between lines.

Press the Setup key to view the following display:

```
LINE nn : X ± DISTANCE l mmm
@ (SPEED) TC : 0 TD : ttttt
```

nn is the line number currently being edited  
mmm is the number of repeats for this particular move  
ttttt is the time delay at the end of the line, in milliseconds.

### Editing the Sequence Data

When editing the data there are three function keys you can use:

Setup - move to the next field to be edited  
Jog+ - move to the next line  
Jog- - move back to the previous line

All the numeric entry keys 0 . . 9, ., ±, DEL, and ENTER operate in the normal way.

When you enter a line screen the cursor is positioned under the axis field. This can be X, Y or DEL (shown on the screen as S). The X/Y key is used to switch between X and Y axes. If the field is 'S', then this line is skipped during execution. Each line defaults to 'S' unless you specify X or Y; this saves deleting all unwanted remaining lines.

Pressing Setup moves the cursor to the distance field, and the distance value will be displayed instead of the text 'Distance'. The range is ±99,999,999 steps.

Press Setup again to move the cursor to the 'I' field. This sets whether the move is to be an incremental or absolute index. The Enter key is used to switch between the two. If an absolute index is selected, the repeat cycle will automatically be set to 1.

Pressing Setup again moves the cursor to the repeat field. You can set the number of repeats between 1 and 255. A zero entry is not allowed.

Press Setup again to move to the speed field; the programmed velocity value is displayed instead of the text 'Speed'. The range is 0.002 to 100.000 revs/sec.

Pressing Setup moves the cursor to the Tool Cycle field. A value of 1 or 0 enables or disables the Tool Cycle function at the end of each move.

Press Setup to move the cursor to the Time Delay field. The value is entered in mS. The delay comes at the end of all the repeats for that line; it is a simple time delay, not a tool cycle.

When you have finished changing the information in the sequence line, press Jog+ to move to the next line. You can also use Jog- to move back to the previous line.

When data has been entered for all required sequence lines, pressing Jog+ again will move to a screen with a Go Home option for each axis.

GO HOME	X axis: 0
	Y axis: 0

When you enter the screen the cursor will be under the X axis option. Entering a 1 or 0 will enable or disable the Go Home move. Pressing Setup moves the cursor to the Y axis option where again a 0 or 1 can be entered. The X axis will go home first.

Press Jog+ again to move to the final screen which enables you to jump back into the sequence at any line. In this way you can create a loop from part or all of the sequence.

GO TO LINE:	0
REPEAT:	1

Enter the number of the line you want to return to. The looping function is disabled if this line number is zero. Press Setup again to move the cursor to the repeat field, and enter the number of times the loop is to be repeated. A repeat value of zero will set up a continuous loop. Press the Mode key to return to the Sequence Mode screen, and then Start to run the sequence.

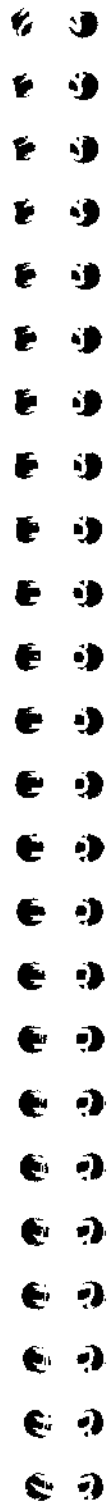

## Chapter 5. SYSTEM SPECIFICATIONS

### Chapter Objective

This chapter is designed to function as a quick-reference tool for system specifications.

### Indexer Specifications

The specifications for the MC20 Keypad Indexer are provided in Table 5-1 below.

Parameter	Value
Axes	2 axes (X & Y) multiplexed. Only one axis may move at a time.
Keypad	Membrane type with snap-action keys
Display	2 lines of 24 characters, backlit LCD
Performance:	
Velocity range	0 - 100 rps
Velocity resolution	0.002 rps at 200 steps/rev
Position range	±16,777,215 steps
Acceleration range	1.22 - 5000 rps <sup>2</sup> at 200 steps/rev
Tool cycle delay	0 - 9999.999 seconds (2-ms increments)
Scaling facility	0.0001 - 9999.99 user units/rev
Selectable motor resolutions ( <i>must match drive resolution</i> )	200, 400, 800, 1000, 2000, 4000, 5000, 10000, 12800, 21600, 25000, 36000 and 50800 steps/rev
Input circuits: (Limits, Home, Start, Stop, Tool In, Reg. mark)	Opto-isolated, requires 12 - 24V to operate. Max. current 20mA at 24V
Outputs: Step	Differential line drive output. Low pulse of 5µs duration causes the motor to move one step. As the resolution increases, the pulse width is reduced to match the drive type. The frequency range is 4Hz - 800kHz.
Direction	Differential line drive output
Tool Out & Aux Out	Emitter/collector outputs 24V at 300mA maximum
AC input	85 - 264VAC at 47 - 63Hz (no switching required)
Auxiliary DC output	24v DC at 200mA max.
Weight	4.0 lbs (1.8kgs)

Table 5-1. MC20 Indexer Specifications

## Chapter 6. MAINTENANCE & TROUBLESHOOTING

### Chapter Objectives

The information in this chapter will enable you to do the following:

- Perform routine system maintenance
- Isolate and resolve system hardware and software problems

### Routine Maintenance

The following are recommendations for routine maintenance on the MC20 Indexer.

#### Connectors

Over a period of time, and particularly if the equipment is subjected to vibration, connectors may come loose. Regularly inspect the connectors to avoid this problem.

#### Cabling

If any of your cabling is exposed or in a position in which it may be damaged, regularly inspect them to anticipate its failure and prevent a machine breakdown.

#### Filters

If you have mounted the electronics rack in a cabinet through which filtered cooling air is passed, you will need to inspect and clean the filters at regular intervals. Failure to do this may result in reduced cooling, leading to overheating and possible failure of the electronics.

### Trouble-shooting

This section discusses methods to identify, isolate, and resolve indexer-related problems that may occur with your system.

#### Problem Isolation

Try to determine if the problem is mechanical, electrical, or software-related. *Can you repeat or re-create the problem?* Do not attempt to make quick rationalizations about problems. Random events may appear to be related, but they are not necessarily contributing factors to your problem. You must carefully investigate and decipher the events that occur before the subsequent system problem.

Verify the operating parameters are correct (see Chapter 4).

You may be experiencing more than one problem. You must solve one problem at a time. Log (document) all testing and problem isolation procedures. You may need to consult these notes later. This will also prevent you from duplicating your testing efforts.

Isolate each system component and ensure that each component functions properly when it is run independently. You may have to remove your system components and re-install them component-by-component to detect the problem. If you have additional components available, you may want to use them to replace existing components in your system to help identify the source of the problem.

**WARNING**

**Make sure to remove power before disconnecting system components or changing wiring.**

Once you have isolated the problem, take the necessary steps to resolve it. Refer to the problem solutions contained in this chapter. If your system's problem persists, call the appropriate phone number shown at the front of this User Guide or your local distributor.

**CAUTION**

**Do not remove the MC20 cover. Removal voids the warranty.**

**Motor Fails to Move**

Test the motor to see if it has holding torque. If there is no holding torque, there are bad connections or bad cables. Remove power and use an ohmmeter to monitor continuity between the cable's motor connector and drive connector or between the drive connector and the indexer connector.

If the unit has holding torque and the motor shaft still fails to move, here are some probable causes:

- The MC20's limit switches or remote stop switch may be tripped or are faulty. Make sure these switches are closed or, if no switches are used, connected to the +24V supply (see *I/O connections* in Chapter 3).
- The load is jammed. You should *hear* the drive attempting to move the motor. Remove AC power from the drive and move the load manually away from the point of the jam.

**Motor Stalls**

A motor stall during acceleration may be caused by one or more of the following factors:

- The velocity setting may be too slow
- The torque requirements may be excessive
- The acceleration ramp may be too steep
- The load inertia and motor inertia may be grossly mismatched.

Lower acceleration may be required.

**Motor Fails to Run at High Speeds**

If the motor fails to run at high speeds, it is possible that the motor may not produce enough torque to move a given load at these velocities. Check the motor's torque/speed curve and make sure you are not trying to exceed the specified performance.

**Reducing Electrical Noise**

Try to eliminate sources of possible noise interference. Potential noise sources include inductive devices such as solenoids, relays, motors, and motor starters operated by a hard contact. Mount the MC20 system in a NEMA-approved enclosure to protect it from electrical noise. For more information on identifying and suppressing electrical noise, refer to the Technical Data section of the *Digiplan Motion Control Catalogue*.

**Returning the System**

If you must return your MC20 indexer system to effect repairs or upgrades, use the following steps:

1. Get the serial number and the model number of the defective unit, and a purchase order number to cover repair costs in the event the unit is determined by the manufacturers to be out of warranty.
2. Before you return the unit, have someone from your organization with a technical understanding of the MC20 indexer system and its application include answers to the following questions:
  - What is the extent of the failure/reason for return?
  - How long did it operate?
  - Did any other items fail at the same time?
  - What was happening when the unit failed (i.e., installing the unit, cycling power, starting other equipment, etc.)?
  - How was the product configured (in detail)?
  - What, if any, cables were modified and how?
  - With what equipment is the unit interfaced?
  - What was the application?
  - What was the system environment (temperature, enclosure, spacing, unit orientation, contaminants, etc.)?
  - What upgrades, if any, are required (hardware, software, user guide)?

3. In UK, call Digiplan for a GRA (Goods Returned Authorisation) number. Returned products cannot be accepted without a GRA number. The phone number for Digiplan Repair Department is 0202 690911. For Customer Service/Applications Department phone 0202 699000.

Ship the unit to: Parker Hannifin plc  
Digiplan Division,  
21, Balena Close,  
Poole,  
Dorset,  
England.  
BH17 7DX

4. In the USA, call Parker Hannifin Corporation, Digiplan Division for a Return Material Authorization (RMA) number. Returned products cannot be accepted without an RMA number. The phone number for Digiplan Division Applications Department is (800) 358-9070.

Ship the unit to: Parker Hannifin Corporation  
Digiplan Division  
5500 Business Park Drive  
Rohnert Park, CA 94928  
Attn: RMA # xxxxxxx

5. Elsewhere: Contact the distributor who supplied the equipment.

## Index

- Absolute indexing, 29
- Acceleration rate, 22
- Accuracy, 19
- Application development, vi
- Atmospheric contamination, v, 9
- Aux-Out, 27
  
- Batch index operation, 30
- Batch move execution modes, 25
- Batch moves: Batch indexing, 30; Batch registration, 34
- Bench test, 3
  
- Cabling, 41
- Configuration procedures, 21
- Conventions, vi
  
- Dangers, vi
  
- Earth loops, 9
- Electrical noise, v, 43
- Electronics concepts, iv
  
- Filters, 41
- Front panel, 1
- Functional block diagram, 1
  
- GRA (Goods Returned Authorisation) number, 44
  
- Holding torque, 42
- Home creep speed, 24
- Home search speed, 24
- Home switch connections, 12
- Homing functions, 24
- Hysteresis, 19
  
- I/O connections, 10
- Incremental indexing, 29
- Index speed (velocity), 23
- Installation: I/O connections, 10; Mounting, 10; Precautions, 9
  
- Jog function, 28
  
- LCD display, 1
- Limit deceleration rate, 25
  
- Limit switch, 25, 30
- Limit switch connections, 12
- Lockout distance, 35
  
- Matrix Mode, 31
- Metal conduit, 9
- Motion control concepts, iv
- Motion profile, 17
  
- Operating modes, 28
  
- Profiles, 17
  
- Registration distance, 35
- Registration mode, 34
- Remote stop switch, 30
- Repeatability, 19
- Reset, 21, 28
- Resonance, 18
- Resources, vi
- Return Material Authorization (RMA) number, 44
- Ringling, 19
  
- Saving parameters, 28
- Scaling function, 21
- Sequence Data, 37
- Shields, 9
- Software reset, 21, 28
- Specifications, 39
- Start switch connections, 12
- Stop switch connections, 13
  
- Tool cycle, 26
- Tool cycle delay, 27
- Tool-In, 27
- Trapezoidal move profile, 18
- Triangular motion profile, 17
- Trouble-shooting, 41
  
- Warning and caution notes, vi
- Window region, 35
  
- X---Y key, 21



## Artisan Technology Group is your source for quality new and certified-used/pre-owned equipment

- FAST SHIPPING AND DELIVERY
- TENS OF THOUSANDS OF IN-STOCK ITEMS
- EQUIPMENT DEMOS
- HUNDREDS OF MANUFACTURERS SUPPORTED
- LEASING/MONTHLY RENTALS
- ITAR CERTIFIED SECURE ASSET SOLUTIONS

### SERVICE CENTER REPAIRS

Experienced engineers and technicians on staff at our full-service, in-house repair center

### *InstraView*<sup>SM</sup> REMOTE INSPECTION

Remotely inspect equipment before purchasing with our interactive website at [www.instraview.com](http://www.instraview.com) ↗

### WE BUY USED EQUIPMENT

Sell your excess, underutilized, and idle used equipment. We also offer credit for buy-backs and trade-ins. [www.artisanng.com/WeBuyEquipment](http://www.artisanng.com/WeBuyEquipment) ↗

### LOOKING FOR MORE INFORMATION?

Visit us on the web at [www.artisanng.com](http://www.artisanng.com) ↗ for more information on price quotations, drivers, technical specifications, manuals, and documentation

**Contact us:** (888) 88-SOURCE | [sales@artisanng.com](mailto:sales@artisanng.com) | [www.artisanng.com](http://www.artisanng.com)