



## Artisan Technology Group is your source for quality new and certified-used/pre-owned equipment

- FAST SHIPPING AND DELIVERY
- TENS OF THOUSANDS OF IN-STOCK ITEMS
- EQUIPMENT DEMOS
- HUNDREDS OF MANUFACTURERS SUPPORTED
- LEASING/MONTHLY RENTALS
- ITAR CERTIFIED SECURE ASSET SOLUTIONS

### SERVICE CENTER REPAIRS

Experienced engineers and technicians on staff at our full-service, in-house repair center

### *InstraView*<sup>SM</sup> REMOTE INSPECTION

Remotely inspect equipment before purchasing with our interactive website at [www.instraview.com](http://www.instraview.com) ↗

### WE BUY USED EQUIPMENT

Sell your excess, underutilized, and idle used equipment. We also offer credit for buy-backs and trade-ins. [www.artisanng.com/WeBuyEquipment](http://www.artisanng.com/WeBuyEquipment) ↗

### LOOKING FOR MORE INFORMATION?

Visit us on the web at [www.artisanng.com](http://www.artisanng.com) ↗ for more information on price quotations, drivers, technical specifications, manuals, and documentation

**Contact us:** (888) 88-SOURCE | [sales@artisanng.com](mailto:sales@artisanng.com) | [www.artisanng.com](http://www.artisanng.com)



# **LIQUILAZ<sup>®</sup>-S** **Liquid Particle Counter** **Operations Manual**

**Without measurement, there is no control.**



# LiQuilaz<sup>®</sup>-S Liquid Particle Counter

## Operations Manual



Particle Measuring Systems Headquarters  
5475 Airport Blvd., Boulder, CO 80301, USA  
(303) 443-7100 1-800-238-1801 FAX: (303) 449-6870  
Instrument Service & Support: 1-800-557-6363  
Customer Response Center: 1-877-475-3317

Particle Measuring Systems Europe  
Tel: +44 (0)1684-581000  
FAX: +44 (0)1684-560337  
PMSEurope@pmeasuring.com

Particle Measuring Systems Singapore  
Tel: 65 6496 0330 FAX: 65 6496 0357  
PMSSingapore@pmeasuring.com

Particle Measuring Systems China  
Room 2006,  
Mingshen Center Building No. 3131  
Kaixuan Road Kuhui District  
Shanghai, 20030  
China  
PMSChina@pmeasuring.com

Particle Measuring Systems Mexico  
PMSMexico@pmeasuring.com  
Particle Measuring Systems Puerto Rico  
PMSPuertoRico@pmeasuring.com  
Particle Measuring Systems Asia Pacific  
PMSAsiaPacific@pmeasuring.com  
Particle Measuring Systems Japan  
PMSJapan@pmeasuring.com

P/N M10195 Rev M

LiQuilaz-S Liquid Particle Counter Operations Manual  
P/N M10195 Rev M  
© 2009 by Particle Measuring Systems, Inc.  
All rights reserved

LiQuilaz<sup>®</sup> is a registered trademark of Particle Measuring Systems, Inc.  
Kalrez<sup>®</sup> is a registered trademark of E. I. du Pont de Nemours and Company.  
Flaretek<sup>®</sup> is a registered trademark of Entegris, Inc.  
KEL-F<sup>®</sup> is a registered trademark of 3M  
Micro-90<sup>®</sup> is a registered trademark of the International Products Corporation  
Radiacwash<sup>™</sup> is a trademark of Biodex Medical Systems, Inc.  
Super Floss<sup>®</sup> and Oral-B<sup>®</sup> are registered trademarks of Procter & Gamble.  
Teflon<sup>®</sup> is a registered trademark of E. I. du Pont de Nemours and Company.

All trademarks appearing in this manual are the property of their respective owners.

**DO NOT REPRODUCE OR DISTRIBUTE**

**CONFIDENTIAL DOCUMENT**

This confidential document contains proprietary information, which is protected by copyright. All rights are reserved. No part of this document may be reproduced, distributed, or transmitted in any form without the prior written consent of Particle Measuring Systems. The information contained in this document is subject to change without notice.

## Quality Statement

The Quality Policy of Particle Measuring Systems is to strive to meet or exceed the needs and expectations of our customers and to align the activities of all employees with the common focus of customer satisfaction through continuous improvement in the quality of our products and services.

## Environmental Information

This equipment must be properly disposed of at end-of-life by means of an authorized waste management system. Information regarding dismantling of the equipment and location of any hazardous materials can be located on our web site at:  
<http://www.pmeasuring.com/support/papers/disassemblyinstructions>.

## Manual Conventions

### WARNING

A warning in the text is used to notify the user of the potential for bodily injury or death.

### CAUTION

A caution in the text is used to highlight an item that if not done, or incorrectly done, could damage the instrument and/or any materials or devices affected by the instrument.

### — — NOTICE — —

A notice in the text is an instructional communication regarding requirements or policies issued by Particle Measuring Systems.

---

**NOTE:** A note in the text is used to highlight an item that is of operational importance to the user.

---

It is important that you observe cautions and warnings while performing the procedures described in this manual. Caution and warning labels are located on and inside the instrument to alert you to potentially hazardous conditions. Please familiarize yourself with this information.

## CE – Declaration of Conformity

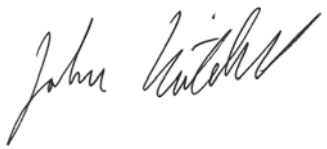
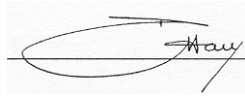
| <b>CE - Declaration of Conformity</b>   |   |
|---|---|
| <b>Application of Council Directive(s):</b>   | 2004/108/EC, 2006/95/EC   |
| <b>Standard(s) to which Conformity is Declared:</b>   | EMC EN 61326-1: 2006  |
|   | Safety EN 61010-1: 2001   |
| <b>Manufacturer's Name:</b>   | Particle Measuring Systems, Inc.  |
| <b>Manufacturer's Address:</b>  | 5475 Airport Boulevard, Boulder, CO 80301 USA   |
| <b>Manufacturer's Telephone/FAX:</b>  | (303) 443-7100 / (303) 449-6870   |
| <b>Distributor's Name:</b>  | Particle Measuring Technique, Great Britain   |
| <b>Distributor's Address</b>  | Unit B1 South, Willow End Park  |
|   | Danemoor, Malvern WR14 1XZ  |
|   | Worcestershire, WR13 6NN United Kingdom   |
| <b>Distributor's Telephone/FAX:</b>   | 011-44-1684-312950 / 011-44-1684-312969   |
| <b>Type of Equipment:</b>   | Particle Monitoring   |
| <b>Model No:</b>  | LiQuilaz-SO2/SO3/SO5-HF   |
| I, the undersigned, hereby declare that the equipment specified above conforms to the above Directive(s) and Standard(s). |   |
| <b>Signature:</b>   | <b>Signature:</b>   |
|                                        |  |
| <b>Full Name:</b> John Mitchell   | <b>Full Name:</b> David Hall  |
| <b>Position:</b> Vice President Engineering   | <b>Position:</b> Managing Director  |
| <b>Place: Boulder</b> Date: June 18, 2008   | <b>Place: Malvern</b> Date: June 18, 2008   |

### CAUTION

All I/O cables and accessories must meet current factory specifications in order for this unit to remain in compliance with CE marking requirements. Consult the factory for details.

# Table of Contents

---

|   |            |
|---|------------|
| Quality Statement                                 | ii         |
| Environmental Information                         | ii         |
| Manual Conventions                                | iii        |
| CE – Declaration of Conformity                    | iv         |
| <b>Chapter 1: Getting Started</b>                 | <b>1-1</b> |
| Specifications                                    | 1-2        |
| <b>Chapter 2: Unpacking and Installation</b>      | <b>2-1</b> |
| Unpacking   | 2-1        |
| Identifying Components and Connections            | 2-1        |
| Liquid Connections                                | 2-1        |
| Indicator Lights                                  | 2-1        |
| Communications Connectors                         | 2-3        |
| Installation Requirements                         | 2-4        |
| AC Fuse   | 2-4        |
| Installation                                      | 2-5        |
| <b>Appendix A: Capillary Cleaning</b>             | <b>A-1</b> |
| Cleaning the Capillary                            | A-1        |
| Applying Additional Capillary Cleaning Techniques | A-2        |
| <b>Appendix B: Communication Protocol</b>         | <b>B-1</b> |
| Instrument Initialization                         | B-1        |
| Sample Initiate                                   | B-1        |
| Data Processing                                   | B-2        |
| Slow Polling                                      | B-2        |
| Fast Polling                                      | B-3        |
| Slow Protocol                                     | B-3        |
| Slow Protocol Commands                            | B-6        |
| Commands and Responses                            | B-7        |
| Format for Calibration String                     | B-9        |
| Fast Protocol                                     | B-11       |
| Formatting Data                                   | B-13       |
| <b>Appendix C: International Precautions</b>      | <b>C-1</b> |
| WARNING   | C-1        |
| AVERTISSEMENT                                     | C-1        |
| WARNUNG   | C-1        |
| ATTENZIONE  | C-1        |
| PRECAUSION  | C-1        |
| Hazard Symbols                                    | C-2        |

# Table of Contents

---

|                                |                  |
|--------------------------------|------------------|
| Symboles de risque             | -----C-2         |
| Warnschilder                   | -----C-3         |
| Simboli di pericolo            | -----C-3         |
| Simbolos de peligro            | -----C-4         |
| <b>Appendix D: 有毒或有害的物质和元素</b> | <b>----- D-1</b> |



# List of Figures

---

|   |     |
|---|-----|
| Figure 1-1: LiQuilaz-S Liquid Particle Counter              | 1-1 |
| Figure 2-1: LiQuilaz-S Liquid Particle Counter (Front View) | 2-2 |
| Figure 2-2: LiQuilaz-S Liquid Particle Counter (Rear Panel) | 2-3 |

# List of Figures

---

---

# Chapter 1

## Getting Started

---

The LiQuilaz<sup>®</sup>-S liquid particle counter is a sensor designed to measure particles in liquids. The sensor contains the liquid handling and optical system as well as the necessary electronics to measure the size of the particles sampled and to transmit this information to the data display system. The sensor requires AC power, connections to bring the liquid to the sensor, and a connection to the data display system.

Particle Measuring Systems supplies several software packages supporting the LiQuilaz-S liquid particle counter depending upon the application.

The following are the sensitivities of LiQuilaz-S sensors:

- 0.5  $\mu\text{m}$  (S05)
- 0.3  $\mu\text{m}$  (S03)
- 0.2  $\mu\text{m}$  (S02).

All models have a sapphire capillary.

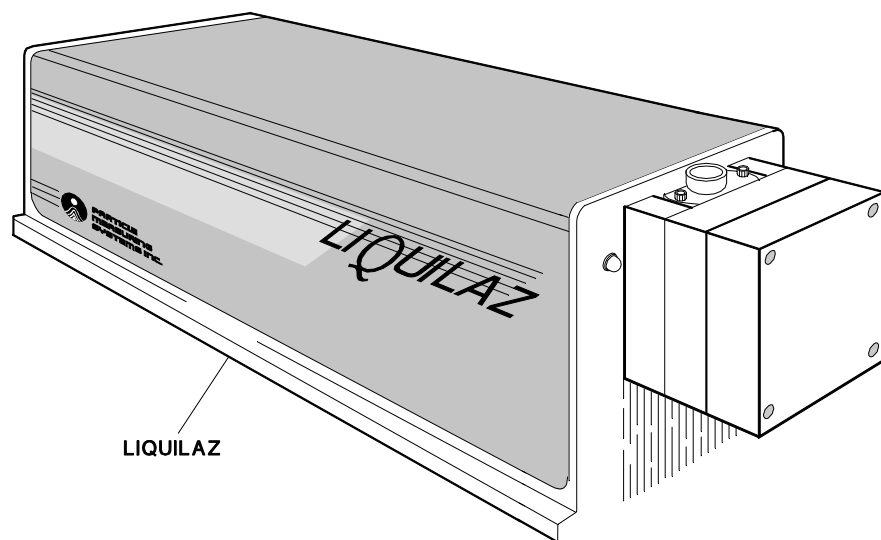

**Figure 1-1: LiQuilaz-S Liquid Particle Counter**

## Specifications

| LiQuilaz-S liquid particle counter models | S02  | S03                        | S05                        |
|---|--|----------------------------|----------------------------|
| Size range                                | 0.2–2.0 $\mu\text{m}$  | 0.3–3.0 $\mu\text{m}$      | 0.5–20.0 $\mu\text{m}$     |
| Size channels                             | 15   |                            |                            |
| Flow rate (mL/min.)                       | 50 $\pm$ 10%   | 80 $\pm$ 10%               | 80 $\pm$ 10%               |
| Volume sampled                            | 100%   |                            |                            |
| Maximum concentration <sup>a</sup>        | 10,000 per mL  |                            |                            |
| Sample temperature <sup>b</sup>           | 0–150°C  |                            |                            |
| Zero count level                          | $\leq$ 25 counts per liter   | $\leq$ 15 counts per liter | $\leq$ 15 counts per liter |
| Maximum psi                               | 100  |                            |                            |
| Laser source                              | Diode laser  |                            |                            |
| Wetted surface materials                  | Sapphire, Teflon®, Kalrez® 4079, or Kel-F®   |                            |                            |
| Dimensions (l, w, h)                      | 12.75 $\times$ 4.25 $\times$ 4.5 inches (32.4 $\times$ 10.8 $\times$ 11.4 cm)        |                            |                            |
| Weight                                    | 6.1 pounds (2.8 kg)  |                            |                            |
| Power                                     | 85–132 V, 50–60 Hz<br>220–240V, 50–60 Hz   |                            |                            |
| Fuses                                     | 85–132 VAC: 0.75 Amp, 3 AG SB/250 V<br>220–240 VAC: 0.63 Amp, T5 x 20 mm 250 V       |                            |                            |
| Communications                            | RS-485   |                            |                            |
| Calibration fluid                         | DI water   |                            |                            |
| Calibration                               | Materials used are traceable to USA NIST and/or Japanese Industrial Standards (JIS). |                            |                            |
| Environment                               | Temperature: 10–35°C    Humidity: non-condensing                                     |                            |                            |

a. Greater than 90% accuracy (less than 10% coincidence loss) at maximum recommended concentration

b. 100°C for sulfuric acid

# Chapter 2

## Unpacking and Installation

---

### Unpacking

#### To unpack your shipment

- 1 Open the container.
- 2 Carefully remove the instrument and inspect it for damage.
- 3 If the instrument has been damaged in shipment, notify the shipper and Particle Measuring Systems. Repackage the instrument in the original packing materials.
- 4 If the instrument is not damaged, store the packing materials.

### Identifying Components and Connections

#### Liquid Connections

The liquid connections to the LiQuilaz-S liquid particle counter are made through either the 3 mm connections directly on the sensor or through the Flaretek<sup>®</sup> connections on the interface bracket. Refer to Figure 2-1, “LiQuilaz-S Liquid Particle Counter (Front View).” Sensors configured to operate with samplers will typically utilize 3 mm tubing. Sensors configured to operate online will typically utilize 1/4” (6 mm) Flaretek fittings.

#### Indicator Lights

An activity light is located on the front panel next to the liquid connections. The LED is illuminated upon detection of each particle, interrogation of the sensor, and failure of the laser. This indicator is used to easily verify proper operation of the unit.



**Figure 2-1: LiQuilaz-S Liquid Particle Counter (Front View)**

---

## Communications Connectors

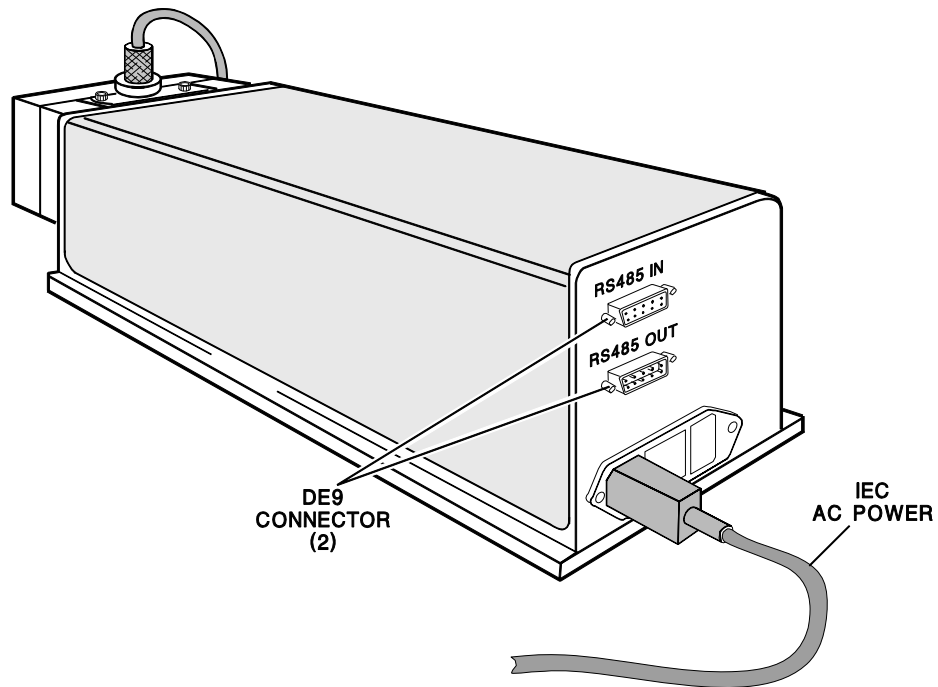

**Figure 2-2: LiQuilaz-S Liquid Particle Counter (Rear Panel)**

Two DE9 (female and male) connectors on the rear panel allow connection to the data display system. When one is used, the other is available for daisy chain connection to other sensors on the network.

A standard IEC AC power entry module, with a power switch, is located on this panel.

## Installation Requirements

**Power** 85–132 VAC, 50–60 Hz  
or 220-240 VAC, 50-60 Hz

**Data cable** 5 wire RS-485 (DE9)

Pin 1 shield  
Pin 2 Tx +  
Pin 3 Tx -  
Pin 4 Rx +  
Pin 5 Rx -  
Pin 6 sample +  
Pin 8 sample -

**Liquid connections** 3 mm zero dead volume fitting  
or 1/4-inch Flaretek

### AC Fuse

The fuse drawer in the sensor’s power entry module permits the use of either of two types of fuse, depending on the line voltage.

#### To replace a fuse

- 1 Unplug the power cord from rear panel of the LiQuilaz-S liquid particle counter.
- 2 Use a small blade screwdriver, or similar tool, to remove the cover/fuse drawer from the power entry module (located on the instrument rear panel).
- 3 Choose the proper fuse according to the table below.

|             |                              |
|-------------|------------------------------|
| 85–132 VAC  | 0.75 Amp<br>3 AG SB/250 V    |
| 220–250 VAC | 0.63 Amp<br>T5 x 20 mm 250 V |

- 4 Reinstall the cover/fuse drawer assembly.



---

## Installation

### To install the particle sensor

- 1 Connect a standard IEC AC power cord to the rear panel power module (Figure 2-2).
- 2 Connect the DE9 data cable between the sensor and the data display system.

---

**NOTE:** If more than one sensor is to be connected to the data display system, they can be daisy chained through this sensor. If connection to an RS-232 communications port is to be made, it is necessary to use an RS-232 to RS-485 converter in this line.

---

- 3 Connect the liquid supply line to the appropriate connector on the front of the sensor.

---

**NOTE:** Although there is no directional requirement by the sensor for flow, Particle Measuring Systems recommends that the flow travel into the bottom connection and out of the top connection. This will help prevent bubbles from becoming trapped in the sample cell by the fluid flow.

---

This page is intentionally left blank

# Appendix A

## Capillary Cleaning

---

This is a basic guide to maintenance for LiQuilaz liquid particle counters. Occasional cleaning is required of the liquid capillary and it is the customer's responsibility to perform the cleaning when necessary. The need for capillary cleaning and the general health of the capillary can be improved by continuously running water through the system when not in use. In addition, the capillary should never be allowed to dry out as this could permanently damage the capillary.

### Cleaning the Capillary

To clean the liquid capillary using syringes

#### WARNING

Before removing the LiQuilaz liquid particle counter from a CLS-700 sampler, make sure the sample inlet and outlet tubes are first connected together, or directed into an appropriate drain. Failure to do so could result in severe personal injury, as water from the sampler will be forced out of the open tubing under pressure.

- 1 Isolate the LiQuilaz liquid particle counter from its fluid source.
- 2 Disconnect the fluid inlet and outlet fittings from the LiQuilaz liquid particle counter.

#### CAUTION

Do NOT remove the 4-40 socket head screws from the fittings. Doing so will compromise the capillary seal and result in fluid leaking onto circuit boards and extensive damage. Only remove 3mm zero dead volume fittings from the inlet/outlet connections.

- 3 Select an appropriate cleaning solution.

---

**NOTE:** When selecting an appropriate cleaning solution, consider the types of contamination that will have deposited onto the capillary from the most recent fluid sampled. For instance, if DI water was sampled last, bacteria, or particles are the most likely sources of contamination. If solvents were sampled last, optical hazing due to chemical impurities is most likely. Both of these situations can be easily remedied using high-quality laboratory glassware cleaner such Micro-90<sup>®</sup> or Radiacwash<sup>™</sup>. A 5% solution of glassware cleaner in ultra-pure DI water should be used.

---

- 4 Fill each cleaning syringe with 5ml of cleaning solution.
- 5 Attach one cleaning syringe to the particle counter inlet, and the other to particle counter outlet.
- 6 Force the cleaning fluid back and forth between the two syringes for 30 seconds to one minute.
- 7 Remove syringes, being careful not to spill fluid into gaps between metal sections of particle counter housing. Immediately wipe up any spills.
- 8 Connect the LiQuilaz liquid particle counter inlet to a source of ultra-pure deionized water. Direct the LiQuilaz liquid particle counter outlet to a drain suitable for the cleaning fluid. Flush the cleaning fluid from particle counter for 3-5 minutes with DI water.
- 9 Check the DC light using the provided software. If the DC light fails to meet the following sensor specifications, repeat cleaning with syringes until successful.

| DC Light Specifications                           |              |
|---|--------------|
| LiQuilaz-S liquid particle counter, model S02     | < 0.5 volts  |
| LiQuilaz-S liquid particle counter, model S03/S05 | < 0.03 volts |
| LiQuilaz-S liquid particle counter, model E20P    | > 7 volts    |

- 10 If a series of cleaning attempts is unsuccessful in cleaning the syringe, follow the cleaning procedure in “Applying Additional Capillary Cleaning Techniques” or return the LiQuilaz liquid particle counter to Particle Measuring Systems Service Department.

## Applying Additional Capillary Cleaning Techniques

In cases where polymers were sampled, the most likely cause of contamination is trace polymer dried to the capillary. In this case, the polymer will probably require long term soaking in the appropriate solvent to facilitate removal of the contaminant.

Using the solvent with the cleaning syringes after soaking (assuming compatibility), should dislodge the residual contamination. Follow this with a DI flush, and, if necessary, additional cleaning with a glassware cleaner.

Sometimes the source of contamination is aggressively attached to the surface of the capillary. When these rare events occur, using cleaning syringes will not be sufficiently effective to return the DC light value to acceptable limits. Under these situations, using a product called Super Floss<sup>®</sup> manufactured by Oral-B<sup>®</sup>, can sometimes dislodge the contamination.

|                |
|----------------|
| <b>CAUTION</b> |
|----------------|

|   |
|---|
| Do NOT use floss on the LiQuilaz E20P particle counter. Floss will damage the capillary on this unit. |
|---|

### To clean the liquid capillary using floss

Follow these steps ONLY after an unsuccessful series of attempts to clean the capillary with the syringes.

- 1 If necessary, remove the 3 mm fittings from the LiQuilaz liquid particle counter inlet and outlet fittings.
- 2 Remove a single strand of Super Floss from its package.

---

**NOTE:** Do not use flavored (mint or other) floss as it can leave a film on the capillary instead of cleaning it.

---

- 3 Identify the un-waxed end of the Super Floss, and insert it through the capillary.

|                |
|----------------|
| <b>CAUTION</b> |
|----------------|

|   |
|---|
| One end of the Super Floss is stiffened with wax, while the other is only compressed into stiff dental floss. Never pass the waxed end through the capillary. |
|---|

- 4 As the spongy section of the Super Floss reaches the capillary, wet it lightly with cleaning solution.

|                |
|----------------|
| <b>CAUTION</b> |
|----------------|

|  |
|--|
| Be very careful not to spill any fluid onto the gaps between the metal sections of the LiQuilaz housing. Immediately wipe up any spills. |
|--|

---

**NOTE:** When selecting an appropriate cleaning solution, consider the types of contamination that will have deposited onto the capillary from the most recent fluid sampled. For instance, if DI water was sampled last, bacteria, or particles are the most likely sources of contamination. If solvents were sampled last, optical hazing due to chemical impurities is most likely. Both of these situations can be easily remedied using high-quality laboratory glassware cleaner such Micro-90 or Radiacwash. A 5% solution of glassware cleaner in ultra-pure DI water should be used.

---

- 5 Gently pull the wetted portion of the Super Floss back and forth through the capillary for 10-15 seconds.

---

**NOTE:** The best technique is to pull on one end of the Super Floss without holding onto the other end. Then, release the side you were pulling, and begin pulling from the other end. This will allow the floss to remain large and spongy as it travels through the capillary, contacting all surfaces of the capillary.

---

- 6 After 10-15 seconds of flossing action, remove the Super Floss from the capillary. Remember to remove the floss from the same direction that it was inserted. Do NOT pull the waxed-end through the capillary.
- 7 Connect the LiQuilaz liquid particle counter inlet to a source of ultra-pure, deionized water.
- 8 Direct the LiQuilaz liquid particle counter outlet to a drain suitable for cleaning fluid.
- 9 Flush cleaning fluid from the LiQuilaz liquid particle counter with DI water for 3-5 minutes.
- 10 Check the DC light using the provided software. If the DC light fails to meet the following sensor specifications, repeat cleaning with one additional strand of Super Floss. If the light still does not meet sensor specifications, return the LiQuilaz liquid particle counter to Particle Measuring Systems Service Department.

| DC Light Specifications                           |              |
|---|--------------|
| LiQuilaz-S liquid particle counter, model S02     | < 0.5 volts  |
| LiQuilaz-S liquid particle counter, model S03/S05 | < 0.03 volts |
| LiQuilaz-S liquid particle counter, model E20P    | > 7 volts    |

## Appendix B

# Communication Protocol

---

---

The LiQuilaz-S liquid particle counter is a “smart” sensor designed to measure particles in liquids. To accommodate Fast histogram displays and remote data collection functions, the particle counter supports both the Fast and Slow communication protocols. A description of the protocols are covered in the following sections.

The following is a presentation of typical command sequences for specific operations. The operations may be one-time command sequences (i.e., instrument initialization) or command sequences that need to be performed repeatedly (i.e., polling for data). A detailed explanation of each command is contained in the protocol section.

### Instrument Initialization

The following command sequence is typical during initialization or re-initialization of the instrument:

```
CSR CDT CMODE
```

This sequence performs a software reset, sets the current date/time into the instrument, and sets the instrument into the correct operational mode.

---

**NOTE:** The operational mode should be set to 1 for regular time-based operation. If the mode is set to other than 1, it is assumed the sensor is attached to a LS-200 sampler. Sampler operation is not covered in this document.

---

### Sample Initiate

The following command sequence is typical when starting the instrument:

```
CSI CSIZE CSS
```

This sequence sets the desired sample interval, sets the channel size values, and starts the LiQuilaz-S liquid particle counter sampling.

## Data Processing

The LiQuilaz-S liquid particle counter can be polled for data in two ways. The first uses what is referred to as *Slow* protocol (which is how all the regular commands are transmitted). The second is what is referred to as *Fast* protocol. The term *Fast* refers to the ability to get data as a sample is created, not after a sample is completed. It should be noted that a combination of *Slow* and *Fast* data polling is allowed.

### Slow Polling

The following sequence is typical for a Slow data poll:

Once the LiQuilaz-S liquid particle counter has started sampling, the user needs to poll the instrument to check its data queue. This is performed by transmitting the CQC command. The instrument responds with a RQC and two values. If the first value is -1, the instrument is not sampling and needs to be re-initialized and started as outlined in Instrument Initialization and Sample Initiate sections. If the instrument responds with a value of 0, then there is no data at this time — send another CQC command. If the instrument responds with a value of 1 or greater, data is present. The user now must transmit the CTD command to receive the stored data. If the data is received with no problems, the user should issue the CPQ command to “pop” the data off of the LiQuilaz-S liquid particle counter data queue. If the data is not received correctly, the CTD command can be reissued. This procedure can now be repeated until the user no longer wishes to receive sample data. The second value reported by the sensor with the RQC response represents its sampling status (1=Sampling).

---

**NOTE:** The CQC command is typically transmitted to the instrument at twice the sample interval.

The LiQuilaz-S liquid particle counter will respond with a value of -1 to a CQC command only after a software reset has occurred. A software reset can occur due to power-up, a CSR command from the user, or an error detected by the watch-dog interrupt.

---



## Fast Polling

The logical sequence of events while performing the Fast data poll is identical to those for the Slow data poll with the following exceptions:

The address of the instrument, logically combined with the value 80Hex, is transmitted instead of the CQC command. The response to the Fast poll command contains the status (sampling or not), the queue count, and the sample data at this point in the sample. The queue count is used just like it was used in the Slow data poll procedure.

---

**NOTE:** The Fast poll command is not typically transmitted any faster than 3 times per second.

---

## Slow Protocol

The general communication procedure in the Slow protocol has what is called a command/response sequence. For each command directed to a LiQuilaz-S liquid particle counter, there is a response generated by the particle counter. The format of the response depends on the particular command. (See “Slow Protocol Commands” for a complete listing of the LiQuilaz-S liquid particle counter commands.) These commands and responses are formatted and packeted to ensure error free communication. The formatting and packeting process is discussed in the following paragraphs.

The process of building a packet can be divided into three logical steps shown below.

In the first step the address of the node is added to the beginning of the data, and a checksum is added to the end of the data. This produces the following un-formatted data structure.

ADDRESS HIGH BYTE|ADDRESS LOW BYTE|FIRST DATA BYTE|SECOND DATA BYTE|...|LAST DATA BYTE|CHECKSUM HIGH BYTE|CHECKSUM LOW BYTE

---

**NOTE:** “|” is used for readability and does not exist in the actual data packet.

---

---

**NOTE:** CHECKSUM is a 16 bit unsigned integer sum of the un-formatted data including the address with the carry bit ignored if an overflow occurs during the calculation. The STX and ETX are not included in the check sum.

---

The second step minimizes difficulties when the network includes devices such as modems. Only visible ASCII characters (32–126), with the exception of the packet delimiting STX and ETX, are transmitted on the network. The non-visible characters and non-ASCII characters are run through the conversion formula shown below before they are transmitted.

The STX and ETX are used as packet delimiters. They are not visible characters but do not cause problems as the NUL, DEL, and other 8-bit data characters can.

| Value of Byte |              | Character(s) transmitted i.e. byte 1H, byte 2H |
|---------------|--------------|--|
| byte          | <20H         | 7BH, byte + 20H                                |
| 7B            | <=byte <80H  | 7CH, byte - 5BH                                |
| 80H           | <= byte <COH | 7DH, byte - 60H                                |
| COH           | <= byte      | 7EH, byte - AOH                                |
| otherwise     |              | byte   |

The following is an example of what a typical command and response packet should look like at this point in the formatting and packeting process:

Command -> CQC

Response -> RQC

This particular LiQuilaz liquid particle counter has an address of 1.

Command transmitted to LiQuilaz liquid particle counter:

ASCII -> { !CQC{ ->8

Hex -> 7B207B214351437B207E38

Response transmitted by the LiQuilaz liquid particle counter:

ASCII -> { !RQC -1 0 {!}U

Hex -> 7B207B21525143202D3120307B217D55

The third step is to preface the ASCII packet formed in the second step with a ASCII STX character and terminate it with an ASCII ETX character (STX = 2, ETX = 3).

The system transmission parameters are listed below.

|                 |      |
|-----------------|------|
| Baud Rate       | 9600 |
| Parity          | one  |
| Bit Transmitted | 8    |
| Stop Bits       | 1    |

## Slow Protocol Commands

| Command                           | Response   | Purpose  |
|-----------------------------------|------------|--|
| NOTE: Commands are case sensitive |            |  |
| CMODE n                           | RMODE      | Select time based or sample based sampling mode                              |
| CSI n                             | RSI        | Set the sample interval, in seconds, for the time based mode                 |
| CDT ...                           | RDT        | Set date and time.   |
| CTD                               | RTD ...    | Transmit a data report.  |
| CPQ                               | RPQ        | Remove the oldest record from queue.   |
| CFQ                               | RFQ        | Delete all un-transmitted reports.   |
| CQC                               | RQC n s    | Returns the number of reports on the transmission queue and sampling status. |
| CSR                               | RSR        | Software reset.  |
| CSS                               | RSS        | Start time based sampling mode.  |
| CTS                               | RTS        | Terminate current sample and stop sampling.                                  |
| CVER                              | RVER ...   | Request LiQuilaz software version.   |
| CSATH ...                         | RSATH n    | Set absolute PHA thresholds.   |
| CRATH                             | RRATH ...  | Read absolute PHA thresholds.  |
| CSPHA ...                         | RSPHA n    | Set the PHA parameters.  |
| CRPHA                             | RRPHA ...  | Read PHA parameters  |
| CLG                               | RLG        | Set LiQuilaz to read low gain channel only.                                  |
| CSIZE ...                         | RSIZE n    | Set channel sizes  |
| CRSIZE                            | RRSIZE ... | Read channel sizes   |
| CSTAB ...                         | RSTAB n    | Set table values.  |
| CRTAB                             | RRTAB      | Read table values.   |
| CADDRESS n                        | RADDRESS n | Set instrument address.  |



|             |   |
|-------------|---|
|             | bit n.5=Not Used  |
|             | bit n.6=Not Used  |
|             | bit n.7=Not Used  |
|             | bit n.8=Not Used  |
|             | NOTE: The bit n.3 is only valid in the time based mode.<br>The bit n.3 is the sample signal line for the sample based mode. |
| DC n <LF>   | D.C. light voltage. The max voltage is 10 volts. $0 < n < 4095$ ; 10 volts corresponds to 4095.                             |
| 1 n <LF>    | Smallest channel particle count. $0 < n < 4294967295$   |
| 2 n <LF>    | $0 < n < 4294967295$  |
| 3 n <LF>    | $0 < n < 4294967295$  |
| . <         |   |
| .           |   |
| .           |   |
| nc n <LF>   | Largest channel particle count.<br>$0 < nc < 32$ ; $0 < n < 4294967295$   |
| CHKSUM <LF> | Check sum of the data packet.<br>$0 \leq \text{CHKSUM} \leq 65536$  |
| <EXT>       | The ETX character is 3.   |

Channel 1 is the channel with the smallest size threshold (i.e., smallest particle bin).

|     |   |
|-----|---|
| CPQ | <b>Pop Queue:</b> Causes the report currently on the top of the transmission-queue to be discarded, for example: the oldest record is deleted. This command does not disturb the sampling process.  |
| CFQ | <b>Flush queue:</b> Discards all reports on the transmission-queue if not sampling.   |
| CQC | <b>Queue Count:</b> Returns the number of reports on the transmission queue and the sampling status (1= sampling).  |
| CSR | <b>Software reset:</b> The system does its best to simulate a hardware reset, typically by stopping keep-alive strobes to a hardware watchdog device. The RSR response will be transmitted <b>after</b> the LiQuilaz liquid particle counter has reset. |

|                                |  |
|--------------------------------|--|
| CSS                            | <b>Start sampling:</b> causes the LiQuilaz liquid particle counter to begin continuous time-base sampling. When the particle counter is in sampler mode, this command has no effect. If the instrument is currently sampling it will abort the sample and start a new sample.  |
| CTS                            | <b>Terminate sampling:</b> causes the particle counter to stop continuous time-mode sampling and return to the idle state. This command has no effect during Sampler mode.   |
| CVER                           | The LiQuilaz liquid particle counter will return the revision number of the software currently running in response to this command. This version can be a string of up to 200 characters in this format RVER LiQuilaz-S, Version 3.0 07-06-94  |
| CSATH nc n1 n2<br>n3 ... n(nc) | Set absolute PHA thresholds. The first number (nc) is the number of thresholds to be programmed. Following the numbers are nc addresses which represent the RAM location boundaries of the channels. For example, channel 1 runs from n1 to n2, channel 2 runs from n2 to n3 and the last channel is all locations greater than n(nc). The maximum values for nc and n? are 31 and 8191 respectively for the LiQuilaz liquid particle counter. The values are stored in battery backup RAM. The last values used will be the default values on power up. Returns 1 if values accepted or 0 if sampling or values out of range. |
| CRATH                          | Read absolute PHA thresholds. The response is RRATH nc 1 2 3 ... nc. The first number (nc) is the number of thresholds that are currently programmed. Following the numbers are nc addresses which represent the RAM location boundaries of the channels. For example, channel 1 runs from n1 to n2, channel 2 runs from n2 to n3 and the last channel is all locations greater than n(nc). The maximum values for nc and n? are 31 and 8191 respectively for the LiQuilaz liquid particle counter.  |
| CSPHA ...                      | Stores the current state of the PHA. The values are stored in battery backup RAM. The last values used will be the default values on power up. The response to the command is RSPHA n. Where n=1 is a valid state of the PHA and n=0 is an invalid state. The detailed format of the command is as follows.  |

## Format for Calibration String

The following calibration information will be downloaded and uploaded as an ASCII string in the LiQuilaz liquid particle counter.

|                    |            |
|--------------------|------------|
| Date               | <MM/DD/YY> |
| Time               | <HH:MM:SS> |
| Gain               | (double)   |
| No. Size/SST pairs | (int)      |

Pairs of Size/SST Combinations

Size (double)

SST (int)

High Gain Offset (int)

Low Gain Offset (int)

Size Checksum (double)

SST Checksum (double)

Each token within the string is separated by spaces (character 0 x 20), and the string is null terminated.

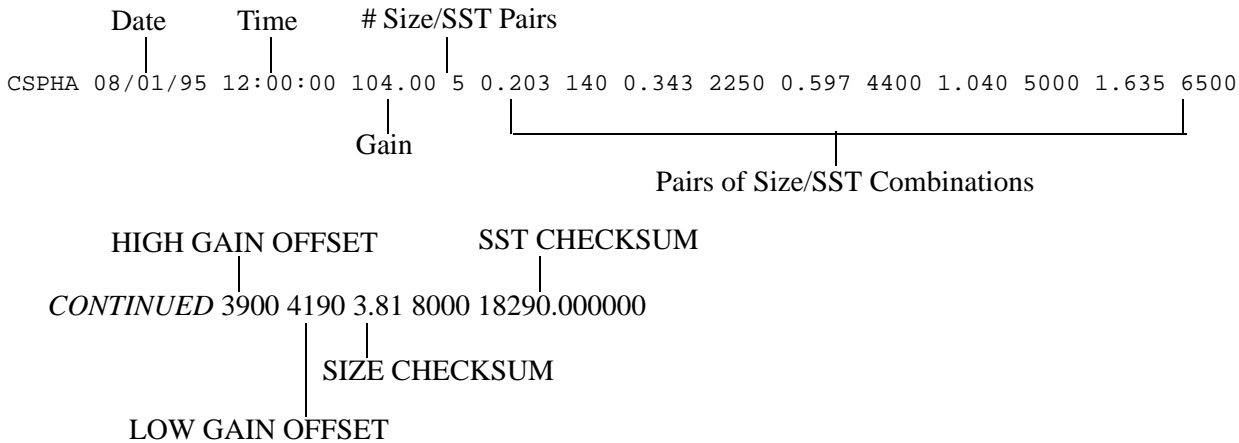

Example: Command -> `CSPHA 08/01/95 12:00:00 104.00 5 0.203 140 0.343 2250 0.597 4400 1.040 5000 1.635 6500 3900 4190 3.81 8000 18290.000000` Response -> `RSPHA 1`

**CRPHA** Returns the current state of the PHA. The format is as follows:  
`CRPHA 08/01/95 12:00:00 104.00 5 0.203 140 0.343 2250 0.597 4400 1.040 5000 1.635 6500 3900 4190 3.81 8000 18290.000000`

**CLG** Restricts the LiQuilaz liquid particle counter to measuring particles in its low gain analog section.



|  |  |
|--|--|
| CSIZE nc n1 n2<br>n3 ... n(nc)             | Set channel sizes. The first number (nc) is the number of sizes to be used. There are then nc actual sizes to set. Returns 1 if sizes are acceptable or 0 if sampling or the sizes are incorrect. Only available in Version 3.0 or later.  |
| CRSIZE                                     | Read channel sizes. The response is RRSIZE nc n1 n2 n3 ... n(nc); where n is a channel size. This will yield data only if the channel sizes were set via the CSIZE command. Only available in Version 3.0 or later.  |
| CSTAB nc a1 b1<br>a2 b2 ... a(nc)<br>b(nc) | Set table values. The first number (nc) is the number of table entries. There are then nc actual table entry pairs. Each pair of values represents size * 1000 and a corresponding threshold value. Returns 1 if entries are acceptable or 0 if sampling or the entries are incorrect. Only available in Version 3.0 or later. |
| CRTAB                                      | Read table values. The response is RRTAB nc a1 b1 a2 b2 ... a(nc) b(nc); where a is a channel size * 1000 and b is a threshold value. This will yield data only if the table values were set via the CSTAB command. Only available in Version 3.0 or later.  |
| CADDRESS n                                 | Set instrument Address. $0 < n < 99$ . Instrument will respond with RADDRESS n at original address. Only available in Version 3.0 or later.  |

Each device will respond with the STX character of a response within a device specific time, approximately 4 seconds or less, if no response is received within this time, a time-out fault condition should be assumed by the host computer.

## Fast Protocol

The Fast communication protocol allows the Data Display System to acquire the most recent data for the sample in progress. This mode operates concurrently with, and independently from, the Slow mode. To initiate a Fast pole, the Data Display System need only transmit the address of the desired device. The address of a device that supports the Fast communication mode is the same as the address of the Slow mode, except that the most significant bit of the address will be set (example: If the device's network address is 1, the Fast mode address is 129).

The following information is transmitted back to the Data Display System per each poll:

- |                      |   |
|----------------------|---|
| 1) ADDRESS           | This is a one byte device address.  |
| 2) SAMPLE_INTERVAL   | This is a 4 byte unsigned number that represents the time elapsed since the start of the sample.<br>(56th of a second)  |
| 3) LASER/FLOW STATUS | bit n.1=Laser Status 1=Laser Good<br><div style="margin-left: 100px;">  Laser Status 0=Laser Bad</div> bit n.2=Not Used |

bit n.3=Flow Rate 1=Flow Rate Good

    | Flow Rate 0=Flow Rate Bad

bit n.4=Not Used

bit n.5=Not Used

bit n.6=Not Used

bit n.7=Not Used

bit n.8=Not Used

NOTE: The bit n.3 is only valid in the time based mode.

The bit n.3 is the sample signal line for the sample based mode.

4) SAMPLE\_STATUS

Time base mode only:

This is a 1 byte sample status. The most significant bit represents the sampling status (i.e., 1 = Sampling, 0 = Not Sampling). The low 7 bits represents the Queue Count. The Queue Count in the Slow and Fast protocols are identical.

Sampler base mode:

Status=1 → Sampling

Status=0 → Not Sampling

5) DC\_LIGHT

A 2-byte unsigned number which represents the DC light voltage in steps of 2.44mv/bit (i.e., 4096 = 10 volts).

6) NUMBER\_CHANNELS

A 1-byte number which represents the number of channels currently programmed into the device.

7) unsigned long CHANNELn

A 4-byte number which represents the number of particles found in the nth channel. CHANNEL 1 is the channel with the smallest size threshold. Each channel is an unsigned long counter. If the device is programmed to have n = 16 channels, a total of 64 bytes can be expected back in this field. For details, see the examples on pages A-13, A-14 and A-15.

8) CHECK\_SUM

A 2-byte number which value is the sum of all the bytes in the “un-formatted data packet” with the exception of the STX, ETX and checksum itself. The carry bit in the addition is ignored. It is transmitted as Low Byte, High Byte.

## Formatting Data

The data is in straight binary format with an STX at the start of the packet and an ETX at the end. Since the STX, and the ETX may be valid values in the actual data, the following algorithm must be used to prevent confusion between data in the packet and delimiting characters:

Format Algorithm:

packet = STX B1 B2 ... BK ... BN ETX  
if Bk equals STX, ETX or FF(hex)

transmit FF(HEX)

transmit Bk exored with 80(hex)

else

transmit Bk

Since the node does not respond to any commands other than those sent to its address, the host computer will initiate a Fast protocol transmission by sending a single 8-bit address character on the network. The lower 7 bits of this character will have a value between 0 and 99 that will correspond to the main network address of the node. The upper (most significant) bit of the address character will be a 1 to indicate that a Fast protocol response is being requested. After the node recognizes its address, it will respond with the following report with each line describing a single character. Note that this is the packet before it is sent to the format algorithm (i.e. this is the un-formatted packet).

<<STX>>

ADDRESS

SI.4

SI.3

SI.2

SI.1

LASER/FLOW STATUS

SAMPLE\_STATUS

DC\_LIGHT.2

DC\_LIGHT.1

NUMBER\_CHANNELS

CHANNEL1.4

CHANNEL1.3

CHANNEL1.2  
CHANNEL1.1  
CHANNEL2.4  
CHANNEL2.3  
CHANNEL2.2  
CHANNEL2.1  
CHANNEL3.4  
CHANNEL3.3  
CHANNEL3.2  
CHANNEL3.1  
.  
.  
.  
CHANNELn.4  
CHANNELn.3  
CHANNELn.2  
CHANNELn.1  
CHECK\_SUM.2  
CHECK\_SUM.1  
<<ETX>>

CHANNEL 1 is the channel with the smallest size threshold. CHECK\_SUM is a 16 bit unsigned summation of all bytes. The STX and ETX characters are not included in the checksum. The carry-bit is ignored if overflow occurs during the calculation of the checksum.

Each device responds with the STX character of a report within approximately 1 second of the receipt of its address. If no response is received within this time a time-out fault condition should be assumed by the host computer.

Example:

---

**NOTE:** All numbers are in hexadecimal.

---



This page is intentionally left blank.

## Appendix C

# International Precautions

---

### **WARNING**

This instrument is a Class I laser product. Use of controls, or adjustment, or performance of procedures other than those specified here may result in hazardous radiation exposure.

### **AVERTISSEMENT**

Cet instrument contient un laser de Classe 1. L'usage de moyens ou procédures, ou la pratique de certains réglages autres que ceux prévus dans ce manuel peuvent entraîner des risques d'exposition aux radiations laser.

### **WARNUNG**

Das Gerät ist ein Laser der Klasse 1. Werden Einstellungen vorgenommen oder Verfahren eingesetzt, die nicht in dieser Bedienungsanleitung beschrieben sind, kann es zu gefährlicher Strahlung kommen.

### **ATTENZIONE**



Questo strumento è nella classe 1 dei prodotti laser. Fare controlli o calibrazioni e seguire procedure diverse da quelle specificate in questo manuale, pu provocare esposizione a radiazioni pericolose.

### **PRECAUSION**

Este equipo es un producto laser de Clase I. La utilización de controles, ajustes o procesos diferentes de los especificados aquí, pueden dar lugar a exposiciones a radiaciones peligrosas.



## Hazard Symbols

The meaning of hazard symbols appearing on the equipment is as follows:

| Symbol  | Nature of Hazard                           |
|---|--|
|  | Attention, consult accompanying documents. |
|  | Dangerous High Voltage                     |
|  | Static Sensitive Components                |

## Symboles de risque



Des symboles représentant les risques sont placés sur l'appareil. Leur signification est la suivante:

| Symbole   | Nature du risque                                     |
|---|--|
|  | Attention, consulter les documents d'accompagnement. |
|  | Danger Electricite                                   |
|  | Composants Sensibles a L'Electricite Statique        |





## Warnschilder

Die, an dem Gerät angebrachten Warnschilder haben folgende Bedeutungen:

| Symbol  | Gefahrenart   |
|---|---|
|  | Achtung! In den beiliegenden Unterlagen nachschlagen. |
|  | Achtung Hochspannung                                  |
|  | Statisch empfindliche Bauteile                        |



## Simboli di pericolo

Il significato dei simboli di pericolo che appaiono sugli strumenti il seguente:

| Simbolo   | Natura del pericolo                          |
|---|--|
|  | Attenzione. Consultare i documenti allegati. |
|  | Tensione Pericolosa                          |
|  | Componenti sensibili a campi elettrostatici  |

## Simbolos de peligro

Los simbolos de peligro que aparecen en el equipo significan:

| Símbolo   | Naturaleza del Peligro                       |
|---|--|
|  | Atención, consultar los documentos adjuntos. |
|  | Peligro alto voltaje.                        |

## Appendix D

### 有毒或有害的物质和元素

| Part Name<br>部件名称 | 有毒或有害的物质和元素 |           |           |                 |               |                 |
|-------------------|-------------|-----------|-----------|-----------------|---------------|-----------------|
|                   | 铅<br>(Pb)   | 汞<br>(Hg) | 镉<br>(Cd) | 六价铬<br>(Cr(VI)) | 多溴联苯<br>(PBB) | 多溴联苯醚<br>(PBDE) |
| 电源供应              | X           | O         | X         | O               | X             | X               |
| 印刷电路装配            | X           | O         | X         | O               | X             | X               |
| 光学元件              | X           | O         | X         | O               | X             | X               |
| 激光                | X           | O         | X         | O               | O             | O               |
| 机械部件              | X           | O         | X         | X               | X             | X               |
| 电缆                | X           | O         | X         | O               | X             | X               |
| 机电                | X           | O         | X         | X               | X             | X               |

O: 表示用于部件的所有同族物质中所含的有毒或有害物质低于SJ/T11363-2006规定的限度要求。  
X: 表示用于部件的至少一种同族物质中所含的有毒或有害物质高于SJ/T11363-2006规定的限度要求。

:

## A

AC Fusing 2-4  
attenzione C-1  
avertissement C-1

## C

calibration 1-2  
calibration fluid 1-2  
commands B-7  
communication protocol B-1  
communications 1-2  
components 2-1  
connections 2-1  
    liquid connections 2-1

## D

daisy chaining 2-5  
data processing B-2  
DE9 connectors 2-3  
Declaration of Conformity 1-iv  
dimensions 1-2

## E

environment 1-2

## F

fast polling B-3  
fast protocol B-11  
flow rate 1-2  
formatting data B-13  
fuses 1-2, 2-4

## I

indicator lights 2-1  
installation 2-1, 2-4, 2-5  
instrument initialization B-1  
international precautions C-1

## L

laser source 1-2  
LED 2-1

## M

manual conventions 1-iii  
maximum concentration 1-2  
maximum psi 1-2

multiple sensors 2-5

## P

power 1-2

## Q

quality 1-ii

## R

RS-232 2-5  
RS-485 2-5

## S

sample initiate B-1  
sample temperature 1-2  
size channels 1-2  
size range 1-2  
slow polling B-2  
slow protocol B-3  
slow protocol commands B-6  
specifications 1-2

## U

unpacking 2-1

## V

volume 1-2

## W

warning C-1  
warnung C-1  
weight 1-2  
wetted surface materials 1-2

## Z

zero count level 1-2





## Artisan Technology Group is your source for quality new and certified-used/pre-owned equipment

- FAST SHIPPING AND DELIVERY
- TENS OF THOUSANDS OF IN-STOCK ITEMS
- EQUIPMENT DEMOS
- HUNDREDS OF MANUFACTURERS SUPPORTED
- LEASING/MONTHLY RENTALS
- ITAR CERTIFIED SECURE ASSET SOLUTIONS

### SERVICE CENTER REPAIRS

Experienced engineers and technicians on staff at our full-service, in-house repair center

### *InstraView*<sup>SM</sup> REMOTE INSPECTION

Remotely inspect equipment before purchasing with our interactive website at [www.instraview.com](http://www.instraview.com) ↗

### WE BUY USED EQUIPMENT

Sell your excess, underutilized, and idle used equipment. We also offer credit for buy-backs and trade-ins. [www.artisanng.com/WeBuyEquipment](http://www.artisanng.com/WeBuyEquipment) ↗

### LOOKING FOR MORE INFORMATION?

Visit us on the web at [www.artisanng.com](http://www.artisanng.com) ↗ for more information on price quotations, drivers, technical specifications, manuals, and documentation

**Contact us:** (888) 88-SOURCE | [sales@artisanng.com](mailto:sales@artisanng.com) | [www.artisanng.com](http://www.artisanng.com)