



Artisan Technology Group is your source for quality new and certified-used/pre-owned equipment

- FAST SHIPPING AND DELIVERY
- TENS OF THOUSANDS OF IN-STOCK ITEMS
- EQUIPMENT DEMOS
- HUNDREDS OF MANUFACTURERS SUPPORTED
- LEASING/MONTHLY RENTALS
- ITAR CERTIFIED SECURE ASSET SOLUTIONS

SERVICE CENTER REPAIRS

Experienced engineers and technicians on staff at our full-service, in-house repair center

*InstraView*SM REMOTE INSPECTION

Remotely inspect equipment before purchasing with our interactive website at www.instraview.com ↗

WE BUY USED EQUIPMENT

Sell your excess, underutilized, and idle used equipment. We also offer credit for buy-backs and trade-ins. www.artisanng.com/WeBuyEquipment ↗

LOOKING FOR MORE INFORMATION?

Visit us on the web at www.artisanng.com ↗ for more information on price quotations, drivers, technical specifications, manuals, and documentation

Contact us: (888) 88-SOURCE | sales@artisanng.com | www.artisanng.com

PUBLICATION NUMBER A 1571
ISSUE 2.5.95

2151 AND 2051

20 GHz AND 2.6 GHz
VXI COUNTERS

RACAL INSTRUMENTS LTD.

RACAL INSTRUMENTS LTD.

480 Bath Road, Slough, Berkshire SL1 6BE, England.
Telephone: (01628) 604455. Fax: (01628) 662017

RACAL INSTRUMENTS INC.

4 Goodyear Street, P.O. Box C-19541, Irvine, CA 92713, USA.
Telephone: (714) 859-8999. Fax: (714) 859 2505

RACAL SYSTEMS ELECTRONIQUE S.A.

18 Avenue Dutarte, 78150 Le Chesnay, France.
Telephone: (1) 39 55 88 88. Fax: (1) 39 55 67 35

RACAL SYSTEMS ELETTRONICA srl

Strada 2, Palazzo C4
20090 Milanofiori Assago Milan, Italy.
Telephone: (02) 5750. 1796 (aut.res.). Fax: (02) 5750.1828

RACAL ELECTRONIK SYSTEM GmbH

Frankenforster Strasse 21, 51427 Bergisch Gladbach 1, Germany.
Telephone: 02204 9222-0. Fax: 02204 21491

RACAL

PUBLICATION DATE: MARCH 1991

Copyright © 1991 by Racal-Dana Instruments Ltd. Printed in England. All rights reserved.
This book or parts thereof may not be reproduced in any form without written permission of the publishers.



CE CONFORMITY:

EC Directives 73/23/EEC, 89/336/EEC, 92/31/EEC and 93/68/EEC

Units that carry the CE mark are designed to conform to standards, EN 61010-1, EN 50081-1, EN 50082-1, when used in accordance with these instructions.

SAFETY

Always operate the product in accordance with the instructions in this manual.

EMC

To ensure that EMC integrity is retained always follow good EMC practice. In particular:

- (1) Use good quality coaxial connections for signal input and output leads
- (2) Use good quality screened data or control cables and connectors.
- (3) Ensure that cable screens are properly terminated within the connectors. Do not use cables if the terminations are loose or frayed.
- (4) Ensure that the screening is continuous through to the chassis of the equipment.
- (5) Ensure that filler panels are fitted to all unused slots in the VXI mainframe.
- (6) Note it may be necessary to fit EMI suppression ferrites to one or more of the connecting leads to ensure compliance of the complete system with EMC regulations.
- (7) Ensure that any associated equipment is CE marked or is of good EMC design and performance.

(2151)

RACAL Instruments Ltd.

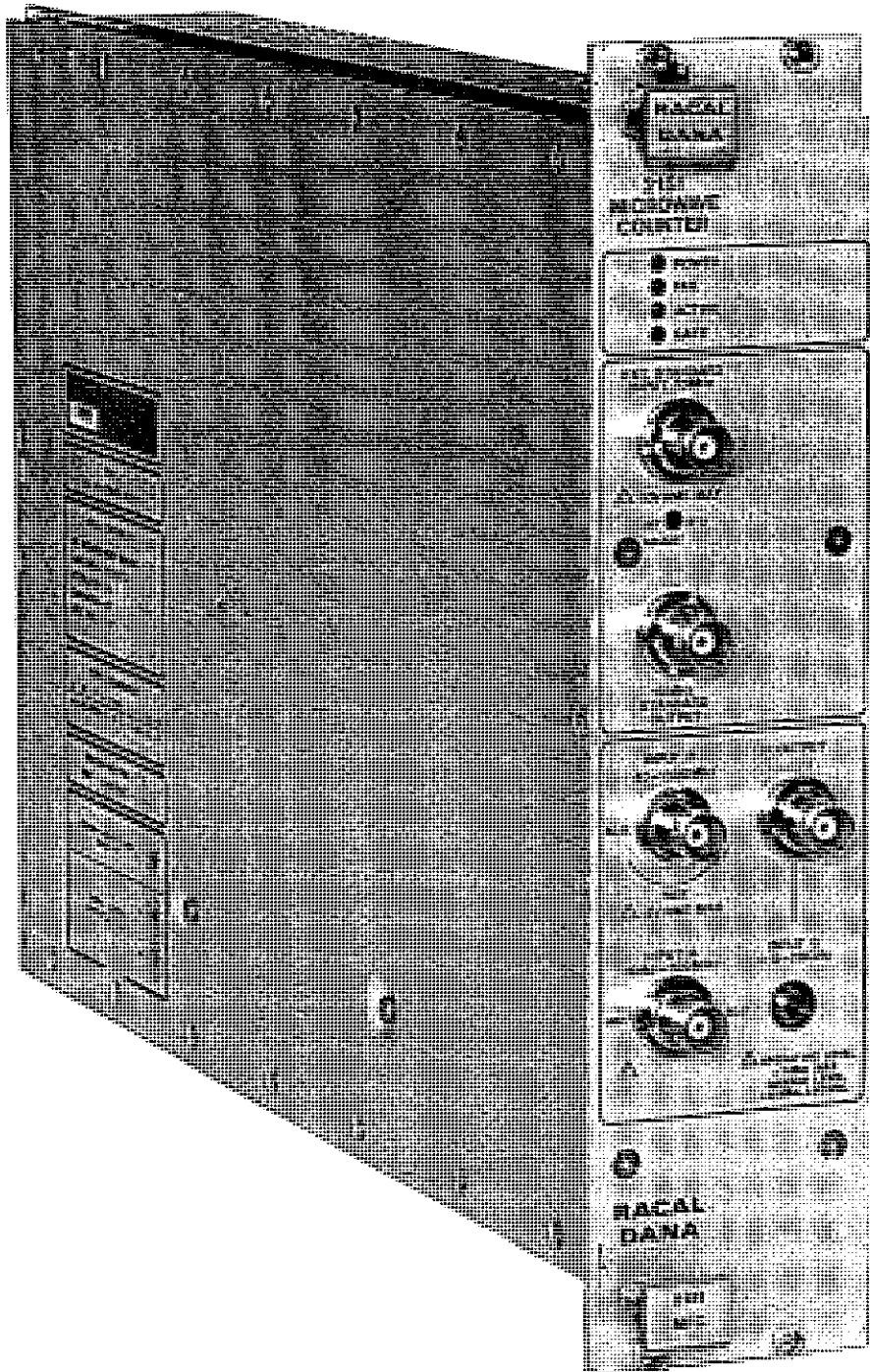

RACAL

A1571

Microwave Counter : 2151

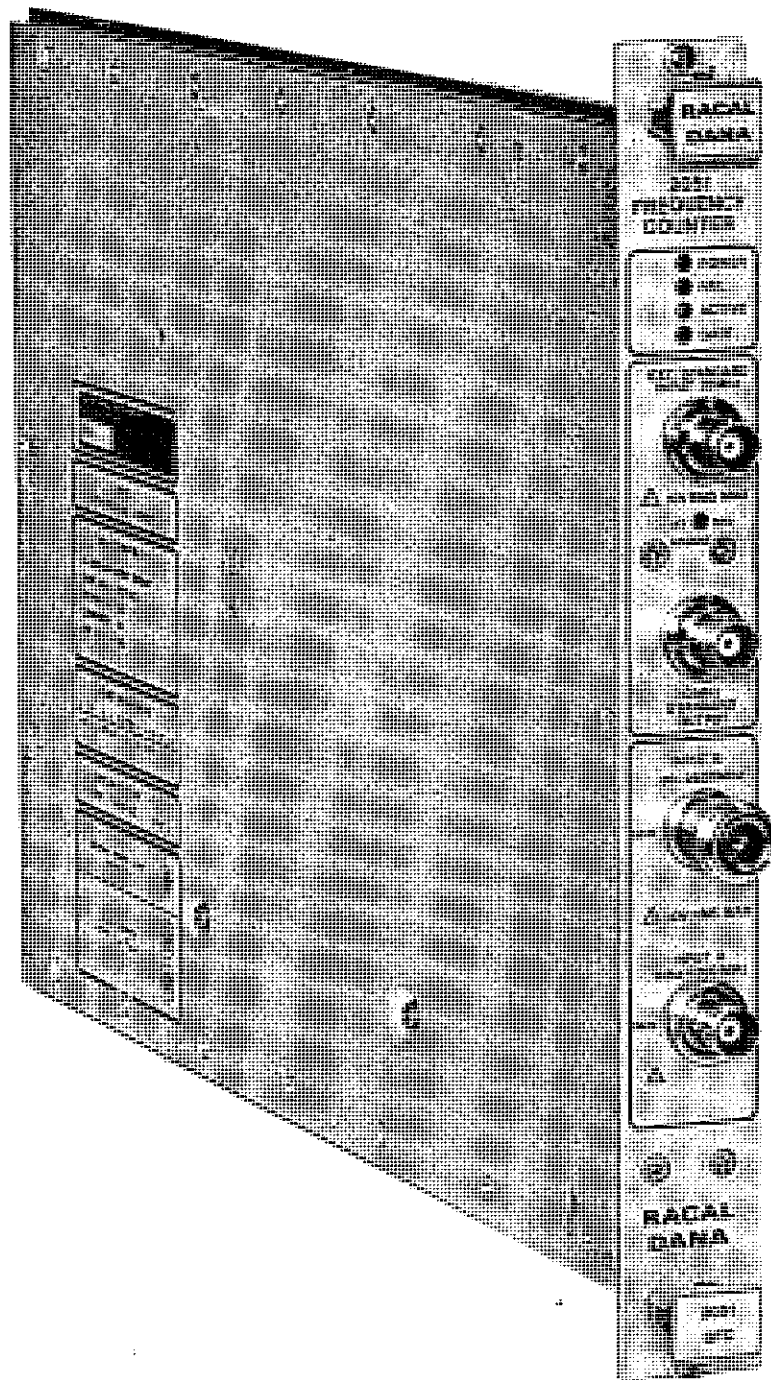

RACAL

A1571

Frequency Counter : 2051

TABLE OF CONTENTS

Paragraph	Title	Page
SECTION 1	TECHNICAL SPECIFICATION	1-1
SECTION 2	GENERAL DESCRIPTION	2-1
1	INTRODUCTION	2-1
3	MEASUREMENT FUNCTIONS	2-1
3	Frequency A Function	2-1
4	Frequency B Function	2-1
5	Frequency C Function (2151 only)	2-1
6	Ratio C/B Function (2151 only)	2-1
7	Ratio C/A Function (2151 only)	2-1
8	Ratio B/A Function... .. .	2-1
9	CHECK FUNCTION	2-2
10	SIGNAL INPUT CHANNELS	2-2
13	ADDITIONAL FREQ C ACQUISITION MODES (2151 ONLY)	2-3
14	MATHS FUNCTIONS	2-3
15	SPECIAL FUNCTIONS	2-3
16	STORE/RECALL FUNCTIONS	2-3
17	SAMPLE RATE	2-3
18	ERROR INDICATION	2-4
19	HOLD FEATURE	2-4
20	RESOLUTION AND GATE TIME	2-4
21	EXTERNAL FREQUENCY STANDARD INPUT	2-4
22	INITIALIZATION	2-4
23	VXI INTERFACE	2-5
SECTION 3	PREPARATION FOR USE... .. .	3-1
1	UNPACKING	3-1
3	SETTING THE LOGICAL ADDRESS AND INTERRUPT PRIORITY SWITCHES	3-1
5	INSTALLATION	3-1
6	Connection to the VXI	3-1
7	FREQUENCY STANDARD	3-1
9	FUNCTIONAL CHECK	3-5
10	VXI Check	3-5
13	CHECK Message Check	3-5
14	Data Output Check	3-6
15	SRQ and Status Byte Check	3-6
16	Input Channel Function Checks	3-7
SECTION 4	OPERATION VIA THE VXI	4-1
1	INTRODUCTION	4-1
2	DESCRIPTION OF FRONT PANEL CONNECTORS AND INDICATORS	4-1
3	DESCRIPTION OF SIDE PANEL SETTING CONTROLS	4-2

TABLE OF CONTENTS (Contd)

Paragraph	Title	Page
4	INITIAL SWITCH-ON	4-3
5	FREQUENCY MEASUREMENT - INPUT A	4-3
6	FREQUENCY MEASUREMENT - INPUT B	4-4
7	FREQUENCY MEASUREMENT - INPUT C (2151 ONLY)	4-4
7	Normal Automatic Mode	4-4
8	Manual Mode	4-5
9	Further Functions in FREQ C (Automatic Mode Only)	4-5
11	Set LOW FM (FREQ C)	4-5
13	Set TRACK (FREQ C)	4-6
15	RATIO MEASUREMENTS C/B (2151 ONLY), C/A (2151 ONLY) AND B/A	4-6
17	MEASUREMENT SAMPLE RATE	4-7
18	Setting and Using the Sample Rate... ..	4-7
19	Interrogating the Sample Rate	4-7
20	MULT FUNCTION	4-7
21	Setting the Multiplier	4-7
22	Enabling the Multiplier	4-7
24	Interrogating the Multiplier	4-7
25	OFFSET FUNCTION	4-8
26	Setting the Offset	4-8
27	Enabling the Offset	4-8
28	Interrogating the Offset	4-8
29	SMOOTH FUNCTION	4-8
31	CLK10 FREQUENCY STANDARD	4-8
33	GATE TIME	4-9
35	SPECIAL FUNCTIONS	4-10
36	Setting the Special Function Register	4-11
38	Enabling and Disabling the Special Functions	4-11
40	ERROR CODES	4-12
41	Clearing the Error Codes	4-12
42	VXI OPERATING MODES	4-13
43	READING OUT DATA	4-13
47	CONTROLLING THE INSTRUMENT	4-13
49	DATA OUTPUT FORMAT - NORMAL	4-14
50	DATA OUTPUT FORMAT - DUMP MODES	4-14
52	REQUESTING SERVICE	4-18
54	STATUS BYTE	4-18
55	SETTING THE ENABLE REGISTERS	4-22
61	MESSAGE PROTOCOL AND SYNTAX	4-22
63	System Message Traffic	4-22
66	Program Messages	4-22
68	Response Messages	4-23
71	White Space Character	4-23
72	OVERLAPPED/SEQUENTIAL COMMANDS	4-23
76	COMMANDS	4-24

TABLE OF CONTENTS (Contd)

LIST OF TABLES

Table	Title	Page
3.1	Decimal to Hexadecimal Conversion	3-2
3.2	P1 VXI Connector Pin Assignment	3-3
3.3	P2 VXI Connector Pin Assignment	3-4
4.1a	Gate Times for FREQUENCIES A and B	4-9
4.1b	Gate Times for FREQUENCY C	4-9
4.2	Major Special Functions	4-10
4.3	Minor Special Functions	4-10
4.4	Error Messages	4-12
4.5	Output Message Format	4-15
4.6	Function Letters	4-16
4.7	Frequency C Dump	4-17
4.8	Frequency A and B Dump	4-17
4.9	Associated Registers	4-18
4.10	Status Byte and Service Request Enable Registers	4-19
4.11	Standard Event Status and Enable Registers	4-20
4.12	Device Defined Event Status and Enable Registers	4-21
4.13a	Common Commands	4-24
4.13b	Common Commands (Continued)	4-25
4.13c	Common Commands (Continued)	4-26
4.13d	Common Commands (Continued)	4-27
4.14a	Device Dependent Commands	4-28
4.14b	Device Dependent Commands (Continued)	4-29
4.14c	Device Dependent Commands (Continued)	4-30
4.14d	Device Dependent Commands (Continued)	4-31
4.14e	Device Dependent Commands (Continued)	4-32
4.14f	Device Dependent Commands (Continued)	4-33
4.14g	Device Dependent Commands (Continued)	4-34
4.14h	Device Dependent Commands (Continued)	4-35
4.14i	Device Dependent Commands (Continued)	4-36
4.14j	Device Dependent Commands (Continued)	4-37
4.14k	Device Dependent Commands (Continued)	4-38
4.14l	Device Dependent Commands (Continued)	4-39
4.15	Permitted Terminators	4-40
4.16	Numerical Input Format	4-40
4.17	Special Function Request (SF?) Response Format	4-41
4.18	Alphabetic List of Required Command Codes	4-41
4.19	Alphabetic List of Optional Command Codes	4-42

SECTION 1

TECHNICAL SPECIFICATION

Model 2151

Technical Specifications

INPUTS

Input A:

Range 10Hz to 100MHz
Sensitivity 20mV rms 10Hz to 80MHz
 30mV 80MHz to 100MHz
Input Impedance 1M ohm/35p F
Maximum Input 260V (DC + AC rms) to 2kHz,
 decreasing to 10V rms at 50kHz
 and above

Input Attenuation x1 and x20, selectable
Filter 50kHz low pass filter selectable

Input B:

Range 40MHz to 1.3GHz
Sensitivity 10mV (to 1GHz)
 75mV (at 1.3GHz)
Input Impedance 50 ohm nominal
Operating Range 10mV to 5V rms
Damage Overload 7V rms (protected by fuse)
VSWR 2.0 : 1 typical (to 1GHz)
AM Tolerance ≥ 90% (for trough > minimum
 pk-pk sensitivity)

Input C:

Range 500MHz to 20GHz
Sensitivity -32dBm (to 12.4GHz)
 -27dBm (to 20GHz)
Maximum Operating Level +7dBm
Damage Level 25dBm peak
 +33dBm with Option 11 high
 power limiter
Input Connector PC 3.5 female
Input VSWR <2 : 1 to 10GHz
 <3 : 1 to 20GHz
AM Tolerance ≥ 90% (for trough > minimum
 pk-pk sensitivity)

2151 OPS
 A1571/DA
 AL01/Iss.01/03.94

FM Tolerance

Mode	Modulation Rate	FM Tolerance Max. Deviation
Automatic Normal Low FM Track	1kHz - 10MHz	20MHz pk-pk
	45Hz - 10MHz	20MHz pk-pk
	300kHz - 10MHz	20MHz pk-pk
Manual	1kHz - 10MHz	60MHz pk-pk

Aquisition Time

Mode	Aquisition Time
Automatic Normal Low FM Track	< 125mSec
	< 1.255mSec
	< 60mSec
Manual	< 20mSec

Tracking Speed

Mode	Tracking Speed
Normal Low FM Track	1MHz/Sec
	80kHz/Sec
	1GHz/Sec

Amplitude Discrimination (typical)

6dB for signals within 500MHz
 20dB for signals at any frequency

Spillover

≥ -50dBm
 (-70dBm if Input A or B selected,
 or sleep mode)

Input C Modes of Operation:

Normal Counter acquires and measures
 frequency of the highest level
 signal within the sensitivity range
 (subject to amplitude
 discrimination specifications).
 Optimum internal local oscillator
 frequency and harmonic number
 are determined automatically.

Low FM	For low modulation rates, Low FM Mode selects an extended acquisition time
Track	For faster measurement and data output rates, Track Mode selects the fastest possible acquisition cycle and tracks the movement of fast moving input frequencies
Manual	For fastest measurement and data output rates, Manual Mode suspends automatic operation and microprocessor calculates optimum internal local oscillator frequency and harmonic number from a user-entered centre frequency NB user enters centre frequency to within ± 20 MHz of input frequency (± 3 MHz below 1GHz) and for full FM tolerance frequency must be entered with ± 1 MHz

IF OUTPUT

Available when measurements are made using Input C in Manual Mode. Available intermittently during gate time in Auto Mode (due to acquisition cycle).

Frequency Range

Automatic Mode and Manual Mode	41MHz to 112MHz
Output Level	-10dBm nominal
Output Impedance	50 ohms nominal
Reverse Damage Level	50V (DC + AC rms) to 210 KHz, decreasing to 3V rms at 3.5 MHz and above.

MEASUREMENT MODES

Frequency A and B:	
Range Frequency A	10Hz to 100MHz
Range Frequency B	40MHz to 1.3GHz
Digits Displayed (Resolution)	3 to 10 digits
LSD Displayed (Hz)	$F \times 10^{-D}$ (F = frequency rounded up to next decade, D = no. of digits)

Frequency C:

Range	500MHz to 20GHz
LSD Displayed (Resolution)	0.1Hz to 1MHz (selectable)
Ratio B/A:	
Available as both software and hardware ratio	
Range	$\frac{40\text{MHz to } 1.3\text{GHz}}{10\text{Hz to } 100\text{MHz}}$
LSD Software	$(\text{Ratio} \times F_B \times 10^{-(D=B)})$ D = No. of digits, F_B = Input B frequency rounded to next decade

LSD Hardware	6-9 digits $\frac{640 \times \text{Ratio}}{F_A \times \text{Gate Time}}$
	3-5 digits As above or $\text{Ratio} \times 10^{(4-D)}$ whichever is the greater (D = No. of digits)

$$\text{Resolution} = \pm \text{LSD} \pm \left[\frac{1.4 \times \text{A Trig Error}}{\text{Gate Time}} \right] \times \text{Ratio}$$

$$\text{Trigger Error} = \frac{[E_i^2 + E_n^2]^{1/2}}{\text{Slew rate at Trigger Point}}$$

E_i = Input noise in 100MHz BW
 E_n = Input amplifier noise

Accuracy \pm Resolution

Ratio C/A, C/B:

Available as software ratio only

$$\text{Range C/A} = \frac{500\text{MHz to } 20\text{GHz}}{10\text{Hz to } 100\text{MHz}}$$

$$\text{Range C/B} = \frac{500\text{MHz to } 20\text{GHz}}{40\text{MHz to } 1.3\text{GHz}}$$

LSD $(\text{Ratio} \times F_C \times 10^{-(D+B)})$
D = No. of digits selected
 F_C = Frequency into input C rounded to next decade

Resolution 0.1Hz to 1MHz (selectable)

$$\text{Accuracy (C/A)} = \pm \frac{(\text{accuracy of } F_C)}{F_C} \pm \frac{\text{accuracy of } F_A}{F_A}$$

$$\text{Accuracy (C/B)} = \pm \frac{(\text{accuracy of } F_C)}{F_C} \pm \frac{\text{accuracy of } F_B}{F_B}$$

Math:	
Multiply	Used to multiply readings by the factor held in the Multiply store (user defined number)
Offset	Used to automatically offset readings by the factor held in the offset store. The factor may be the current reading or a user defined number.
Smooth	Selects a running average function in order to display the optimum resolution relevant to the stability of the input signal

Standard Output:	
Frequency	10MHz
Level	TTL compatible giving approximately 1V p-p into 50 ohms
Impedance	90 ohms nominal
Maximum reverse applied input	± 15V with no permanent damage

TIMEBASE SPECIFICATIONS

Internal Standard: (TCXO)	
Frequency	10MHz
Adjustment Range	± 5ppm min.(multiple turn trimmer)
Aging	1ppm/year
Temp. Stability	± 1ppm max. with respect to frequency at 25°C from 0°C to 40°C
External Standard Input:	
Frequency	10MHz
Signal Range	100mV rms (sine) to 10Vrms (sine)
Damage Level	10V rms (sine)
Input Impedance	1kohm nominal for signals < 1V pk-pk 500 ohm nominal for signals ≥ 10V pk-pk
Coupling	AC coupled
VXIbus "CLK10" Standard	A 10 MHz system clock is sourced from the VXIbus slot 0 controller, distributed on connector P2, differential ECL
Reference Clock	If an external 10MHz reference is connected via front panel input, it will automatically override the internal TCXO reference. This is the "counter reference" Interface commands enable selection of reference from "counter reference" or from "CLK10" input available on VXIbus backplane
Check	10MHz displayed

GENERAL SPECIFICATIONS

Gate Times	Automatically determined depending on resolution selected
Range	1mSec to 20Sec (10Sec max. for channel C)
Sample Rate	Rate selectable and the value displayed
Front Panel:	
Indicators	Fail : Red Active : Amber Gate : Green Power : Green
Input/Output Connectors	A channel input (BNC female) B channel input (BNC female) C channel input precision connector, PC 3.5 female) External standard input (BNC female) 10MHz standard output (BNC female) IF output for Channel C (BNC female)
Rear Panel Components	VXIbus interface sockets P1 and P2 (96-pin DIN pattern)
Side Panel Components	Logical address selection switches interrupt level selection switch

2151 OPS
A1571/DA
AL01/Iss.01/03.94

1-3

Power Requirements:

Voltage

Voltage	Current
-2VDC	0A
+5VDC	840mA
+5V DC (standby)	0A
-5.2V DC	825mA
+12V DC	600mA
-12V DC	0A
+24V DC	172mA
-24V DC	0A

Power Rating <20W

Operating Temp. Range 0°C to 50°C

Storage Temp. Range -40°C to +70°C

Safety Designed to meet the requirements of IEC 348 and follow the guidelines of UL 1244

Cooling Requirements:

Air Flow 0.43 litres/sec
Differential Pressure 0.3mm Hz0

This is the recommended working point to give a 10°C maximum rise in temperature for both 2051 and 2151.

VXIbus SPECIFICATIONS

Device type VXIbus message based instrument

Compatibility Fully compatible with VXIbus System Specification Revision 1.2 for message based instruments

Protocol Word Serial, IEEE-STD-488.2

Output Engineering format, 12 digits and exponent

Module C-size, 2 slot wide
262mm (H) x 60.7mm (W) x 355mm (D)
Weight 3.0 kg maximum

Logical Address Switch selectable 1 to 254

Interrupt Levels Switch selectable 1 to 7

1-4

OPTIONS

Option 11 Power Limiter

Internally fitted to increase Input C protection

Max. CW Power 36dBm (4W) to 18GHz
decreasing to 34dBm (2W) at 20GHz

Insertion Loss 3 to 4dB depending on frequency

Ordering Information

2151	20GHz VXIbus Microwave Counter
------	--------------------------------

OPTIONS

11	Input Power Limiter	11-9011
69	1.3GHz Fuse (pkt 5)	11-1718
93	High Impedance 100MHz probe	23-9104

SUPPLIED ACCESSORIES

Operators Manual

Spare Channel B (1.3GHz) Fuse

2151 OPS
A1571/DA
AL01/Iss.01/03.94

MODEL 2051

Technical Specifications

INPUTS

Input A:

See 2151 Specifications

Input B:

Range	40MHz to 2.6GHz
Sensitivity	Better than 10mV 80MHz to 2.6GHz
Operating Range	10mV to 4V rms
Damage Overload	+33dBm 10mV rms
AM Tolerance	≥90% (for trough > minimum pk-pk sensitivity) (80MHz to 1GHz)

Power Requirements:

Voltage

Voltage	Current
-2VDC	0A
+5VDC	840mA
+5V DC (standby)	0A
-5.2V DC	735mA
+12V DC	190mA
-12V DC	0A
+24V DC	0A
-24V DC	0A

Power Rating ≤11W

Module C-size, 1 slot wide
262mm (H) x 30-18mm (W)
x 355mm (D)
Weight 2.2 kg maximum

All other specifications - see 2151 specifications.

Ordering Information

2051	2.6GHz VXIbus Frequency Counter
------	---------------------------------

2151 OPS
A1571/DA
AL01/Iss.01/03.94

INTRODUCTION

- 1 The Racal Instruments VXIbus microwave counter, Model 2151, is a microprocessor-controlled instrument offering high-accuracy measurements with a comprehensive range of facilities. These facilities include Automatic/Manual Operation, Tracking, Offset, Multiply, and Store and Recall. All the instrument's functions are controlled remotely via the VXI interface.
- 2 The Racal Instruments VXIbus UHF counter, Model 2051, offers high accuracy measurement over a reduced frequency range, with a similar range of facilities to those provided on the Model 2151.

MEASUREMENT FUNCTIONS**Frequency A Function**

- 3 The Frequency A Function is used to measure the frequency of the signal applied to INPUT A. A resolution of up to ten digits can be selected with a gate time of 1 millisecond to 20 seconds depending on the resolution selected.

Frequency B Function

- 4 The Frequency B Function is used to measure the frequency of the signal applied to INPUT B. A resolution of up to ten digits can be selected with a gate time of 1 millisecond to 20 seconds depending on the resolution selected.

Frequency C Function (2151 only)

- 5 The Frequency C Function is used to measure the frequency of the signal applied to INPUT C. A resolution of 0.1 Hz to 1 MHz can be selected with a gate time of 1 millisecond to 10 seconds depending on the resolution selected and frequency being sampled.

Ratio C/B Function (2151 only)

- 6 The Ratio C/B Function is used to measure the ratio of the frequency applied to INPUT C to that applied to INPUT B.

Ratio C/A Function (2151 only)

- 7 The Ratio C/A Function is used to measure the ratio of the frequency applied to INPUT C to that applied to INPUT A.

Ratio B/A Function

- 8 The Ratio B/A Function is used to measure the ratio of the frequency applied to INPUT B to that applied to INPUT A.

CHECK FUNCTION

- 9 The check function measures the internal standard frequency to confirm counter operation. With the CHECK function selected a number of functional tests of the instrument's circuits can be made without the use of additional test equipment (Special Functions 71 to 75). Although these tests do not check the instrument's performance to its published specification, they can be used to verify that the instrument is operating correctly.

SIGNAL INPUT CHANNELS

- 10 Signal input channels A, B and C are fully independent.

The main characteristics of INPUT A are as follows:

- (1) Frequency range of 10 Hz to 100 MHz;
- (2) BNC input connector;
- (3) Input impedance of 1 MegOhm;
- (4) Damage overload of 260 V (DC & AC r.m.s.) to 2 kHz, reducing to 10 V r.m.s. at 50 kHz and above.
- (5) 50 kHz Low Pass Filter (selectable).
- (6) x20 Attenuator (selectable).

- 11 The main characteristics of INPUT B are as follows:

- (1) Frequency range of 40 MHz to 1.3 GHz (2151) or 80 MHz to 2.6 GHz (2051);
- (2) BNC input connector (Fused) (2151 only);
- (3) Input impedance of 50 Ohms;
- (4) Damage overload of +29 dBm protected by the fuse inside the input connector (2151 only).
- (5) Overload trip level of 4.8 V r.m.s. (2051 only)

- 12 The main characteristics of INPUT C (2151 only) are as follows:

- (1) Frequency range of 500 MHz to 20 GHz;
- (2) Input connector - Type APC 3.5;
- (3) Input impedance of 50 Ohms;
- (4) Damage overload of +25 dBm peak.

ADDITIONAL FREQ C ACQUISITION MODES (2151 ONLY)

- 13
- (1) **MANUAL** - This function is used to override the automatic acquisition cycle of FREQ C. It enables the user to enter manually a center frequency and achieve the fastest possible read rates.
 - (2) **LOW FM** - When enabled this function selects an extended acquisition time to enable frequency readings of signals with low modulation rates. This function is used only during FREQ C measurements.
 - (3) **TRACK** - When enabled this function selects the fastest possible auto-acquisition cycle to enable swept-frequency readings. This function is used only during FREQ C measurements.

MATHS FUNCTIONS

- 14
- (1) **MULT** - When activated this function scales readings by the factor stored in the 'MULT' store.
 - (2) **OFFSET** - When activated this function displays the difference between the measured value and the number held in the 'OFFSET' store.
 - (3) **SMOOTH** - This is a Special Function (SF 21). Selecting SMOOTH causes the counter to take a running average of the input frequency.

SPECIAL FUNCTIONS

- 15
- This function preselects special functions and enables them.

STORE/RECALL FUNCTIONS

- 16
- (1) **STORE** - This function enables the operator to store data in specific stores.
 - (2) **RECALL** - This function enables the operator to recall the contents of specific stores.

SAMPLE RATE

- 17
- SAMPLE** - This function is continuously enabled and controls the sample rate.

ERROR INDICATION

- 18 Certain errors in the operation of the instrument will result in the generation of error codes.

HOLD FEATURE

- 19 The Hold feature allows readings to be held indefinitely. A new measurement cycle is initiated using the MEAS?, *TRG or word serial TRIGGER.

RESOLUTION AND GATE TIME

- 20 The gate time is determined by the resolution selected. Details of the relationship between gate time and resolution for each measurement mode are given in Section 4 of this manual.

EXTERNAL FREQUENCY STANDARD INPUT

- 21 The instrument normally uses the internal frequency standard but may be operated using an external frequency standard. The instrument will operate from the external standard, in preference to the internal standard (TCXO), whenever the signal at the EXT. STD. INPUT socket is of sufficient amplitude. It will revert to operation from the internal standard automatically if the input from the external standard is removed. Selection of the CLK10 frequency standard overrides the internal or external frequency standard, this is supplied to the instrument via a rear edge connector (P2) and is software selectable.

INITIALIZATION

- 22 When the instrument is first switched on, or when it is initialized under program control, it will perform the following:

- (1) A software and hardware check. Error messages will be generated if a fault is found.
- (2) The instrument will then set itself to the following state:

	<u>FUNCTION</u>	<u>STATE</u>
(a)	MEASUREMENT MODE	FREQ C (2151), FREQ B (2051)
(b)	RESOLUTION	1 Hz (2151), 9 digits (2051)
(c)	MANUAL	OFF (Store value: 1 GHz) (2151 only)

(d)	SF	OFF (Store value: 10, 20, 30, 40, 50, 60, 70, 80, 90)
(e)	MULT	OFF (Store value: 1)
(f)	OFFSET	OFF (Store value: 0)
(g)	SAMPLE RATE	OPTIMUM (Store value: 0)
(h)	LOW FM	OFF (2151 only)
(j)	TRACK	OFF (2151 only)
(k)	HOLD	OFF (2151 only)
(l)	LO Store (for SF41)	340 MHz (2151 only)
(m)	HN Store (for SF41)	-37 (2151 only)
(n)	DUMP Mode	OFF

VXI INTERFACE

23

All the instruments functions are controlled via the VXI. The VXI may interface the instrument to different control media including GPIB, RS232 and Ethernet.

UNPACKING

- 1 Unpack the instrument carefully to avoid unnecessary damage to the factory packing. If it becomes necessary to return the instrument to Racal Instruments for calibration or repair, the original packaging should be used. If this is not possible, a strong shipping container should be used. Ensure that sufficient internal packing is used to prevent movement of the instrument within the container during transit.
- 2 The MBA link (LK3) is normally set for operation on VXI Revision 1.3 (i.e. link open). Reposition link (i.e. link closed) for operation on VXI Revision 1.2.

SETTING THE LOGICAL ADDRESS AND INTERRUPT PRIORITY SWITCHES

- 3 Set the Logical address in the range 1 to 254 (decimal) by setting the two switches to the hexadecimal equivalent. To set the switches use a small flat bladed screwdriver. See TABLE 3.1 for the decimal to hexadecimal conversion.
- 4 Set the Interrupt Priority in the range 1 to 7 by setting the switch to the required number, use a small flat bladed screwdriver. Do not attempt to set this switch to positions 8, 9 and 0.

INSTALLATION

- 5 After setting the Logical Address and Interrupt Priority Switches, install the instrument in the chassis. Insert the instrument in its slot, ensuring that it is correctly located in the runners, and push it gently into the chassis until the instrument plugs (P1 and P2) connect with their respective sockets at the rear of the chassis. Lock the instrument in the chassis by tightening the locking screws at the top and bottom of the instrument front panel. Ensure that the IACK daisy chain jumpers or switches are open for the appropriate slot (see chassis instructions).

Connection to the VXI

- 6 Connection to the VXI is made via two 96 pin connectors (P1 and P2) mounted on the rear edge of the instrument board. The pin assignments are given in TABLE 3.2 and TABLE 3.3.

FREQUENCY STANDARD

- 7 Three frequency standards are available for use, these are the instruments own internal frequency standard, a 10 MHz standard connected to the EXT. STD connector or the CLK10 standard. The CLK10 standard is selected under program control. The connection for the external standard should be made using coaxial cable. Switch on the frequency standard and the instrument.

TABLE 3.1

Decimal to Hexadecimal Conversion

Dec.	Hex.	Dec.	Hex.	Dec.	Hex.	Dec.	Hex.	Dec.	Hex.
1	01	44	2C	87	57	130	82	173	AD
2	02	45	2D	88	58	131	83	174	AE
3	03	46	2E	89	59	132	84	175	AF
4	04	47	2F	90	5A	133	85	176	B0
5	05	48	30	91	5B	134	86	177	B1
6	06	49	31	92	5C	135	87	178	B2
7	07	50	32	93	5D	136	88	179	B3
8	08	51	33	94	5E	137	89	180	B4
9	09	52	34	95	5F	138	8A	181	B5
10	0A	53	35	96	60	139	8B	182	B6
11	0B	54	36	97	61	140	8C	183	B7
12	0C	55	37	98	62	141	8D	184	B8
13	0D	56	38	99	63	142	8E	185	B9
14	0E	57	39	100	64	143	8F	186	BA
15	0F	58	3A	101	65	144	90	187	BB
16	10	59	3B	102	66	145	91	188	BC
17	11	60	3C	103	67	146	92	189	BD
18	12	61	3D	104	68	147	93	190	BE
19	13	62	3E	105	69	148	94	191	BF
20	14	63	3F	106	6A	149	95	192	C0
21	15	64	40	107	6B	150	96	193	C1
22	16	65	41	108	6C	151	97	194	C2
23	17	66	42	109	6D	152	98	195	C3
24	18	67	43	110	6E	153	99	196	C4
25	19	68	44	111	6F	154	9A	197	C5
26	1A	69	45	112	70	155	9B	198	C6
27	1B	70	46	113	71	156	9C	199	C7
28	1C	71	47	114	72	157	9D	200	C8
29	1D	72	48	115	73	158	9E	201	C9
30	1E	73	49	116	74	159	9F	202	CA
31	1F	74	4A	117	75	160	A0	203	CB
32	20	75	4B	118	76	161	A1	204	CC
33	21	76	4C	119	77	162	A2	205	CD
34	22	77	4D	120	78	163	A3	206	CE
35	23	78	4E	121	79	164	A4	207	CF
36	24	79	4F	122	7A	165	A5	208	D0
37	25	80	50	123	7B	166	A6	209	D1
38	26	81	51	124	7C	167	A7	210	D2
39	27	82	52	125	7D	168	A8	211	D3
40	28	83	53	126	7E	169	A9	212	D4
41	29	84	54	127	7F	170	AA	213	D5
42	2A	85	55	128	80	171	AB	214	D6
43	2B	86	56	129	81	172	AC	215	D7

8

A 10 MHz signal, derived from the standard in use, is available at the 10 MHz STD OUTPUT connector on the front panel of the instrument. If this signal is used, the connection should be made using coaxial cable.

TABLE 3.2

P1 VXI Connector Pin Assignment

Pin	Row A Signal Mnemonic	Row B Signal Mnemonic	Row C Signal Mnemonic
1	D00	BBSY*	D08
2	D01	BCLR*	D09
3	D02	ACFAIL*	D10
4	D03	BG0IN*	D11
5	D04	BG0OUT*	D12
6	D05	BG1IN*	D13
7	D06	BG1OUT*	D14
8	D07	BG2IN*	D15
9	GND	BG2OUT*	GND
10	SYSCLK	BG3IN*	SYSFAIL*
11	GND	BG3OUT*	BERR*
12	DS1*	BR0*	SYSRESET*
13	DS0*	BR1*	LWORD*
14	WRITE*	BR2*	AM5
15	GND	BR3*	A23
16	DTACK*	AM0	A22
17	GND	AM1	A21
18	AS*	AM2	A20
19	GND	AM3	A19
20	IACK*	GND	A18
21	IACKIN*	SERCLK	A17
22	IACKOUT*	SERDAT*	A16
23	AM4	GND	A15
24	A07	IRQ7*	A14
25	A06	IRQ6*	A13
26	A05	IRQ5*	A12
27	A04	IRQ4*	A11
28	A03	IRQ3*	A10
29	A02	IRQ2*	A09
30	A01	IRQ1*	A08
31	-12V	+5V STBY	+12V
32	+5V	+5V	+5V

TABLE 3.3

P2 VXI Connector Pin Assignment

Pin	Row A Signal Mnemonic	Row B Signal Mnemonic	Row C Signal Mnemonic
1	ECLTRG0	+5V	CLK10+
2	-2V	GND	CLK10-
3	ECLTRG1	RSV1	GND
4	GND	A24	-5.2V
5	LBUSA00	A25	LBUSC00
6	LBUSA01	A26	LBUSC01
7	-5.2V	A27	GND
8	LBUSA02	A28	LBUSC02
9	LBUSA03	A29	LBUSC03
10	GND	A30	GND
11	LBUSA04	A31	LBUSC04
12	LBUSA05	GND	LBUSC05
13	-5.2V	+5V	-2V
14	LBUSA06	D16	LBUSC06
15	LBUSA07	D17	LBUSC07
16	GND	D18	GND
17	LBUSA08	D19	LBUSC08
18	LBUSA09	D20	LBUSC09
19	-5.2V	D21	-5.2V
20	LBUSA10	D22	LBUSC10
21	LBUSA11	D23	LBUSC11
22	GND	GND	GND
23	TTLTRG0*	D24	TTLTRG1*
24	TTLTRG2*	D25	TTLTRG2*
25	+5V	D26	GND
26	TTLTRG4*	D27	TTLTRG5*
27	TTLTRG6*	D28	TTLTRG7*
28	GND	D29	GND
29	RSV2	D30	RSV3
30	MODID	D31	GND
31	GND	GND	+24V
32	SUMBUS	+5V	-24V

FUNCTIONAL CHECK

- 9 The functional check tests the operation of many of the instrument's circuits to establish whether the instrument is functioning correctly. The procedure should be followed when the instrument is first taken into use, and after transportation to a new location. It does not check that the instrument is operating to the published specification. Detailed specification tests are given in the Maintenance Manual. Switch the instrument on, it will then set itself to the initialized state.

VXI Check

- 10 The procedure which follows checks the ability of the instrument to accept, process and send IEEE 488.2 messages via the VXI.
- 11 Connect the controller to the VXI interface via its communication medium (e.g. GPIB, RS232, Ethernet etc.). It is assumed that the logical address of the instrument is 02 (to change the instrument address see "SETTING THE LOGICAL ADDRESS AND INTERRUPT PRIORITY SWITCHES"). See your VXI Interface Device manual for details on how the 2151/2051's logical address is mapped to an external address, (it is assumed in the following instructions that the logical address is mapped directly to the external address). The interrupt switch should be set to a corresponding interrupt handler within the interface device.
- 12 Successful completion of the VXI check proves that the instrument's VXI interface is operating correctly and the instrument is responding. The procedure does not check that all the device-dependent commands can be executed. However, if the VXI interface works correctly and the instrument operates correctly, there is a high probability that it will respond to all device-dependent commands.

CHECK Message Check

- 13 Switch the instrument and the controller ON. The red FAILED indicator will light for approximately two to three seconds and then go off after the instrument has finished its self-test. If the indicator does not light, or it remains on, there is a fault on the VXI board. The amber ACTIVE indicator should flash when the SLOT 0 controller configures the system (after five seconds) and then remain off. If the indicator does not flash, or if it flashes continuously, there is a fault on the VXI board.

Data Output Check

14 Test as follows:

Action	Controller Code
Set the instrument to the check mode.	"CHECK"
Request a measurement to be taken and the result placed in the output queue.	"MEAS?"

Read back the result and check that the controller displays CK+00010.00000000E+06 with the cursor moved to the next line, indicating that the line feed (LF) and last byte identifier have been accepted.

SRQ and Status Byte Check

NOTE: This check requires that the Interrupt Priority switch be set to a value coincident with an interrupt handler in the interface device (refer to the VXIbus System Specification for details on Interrupt Priority).

15 Test as follows:

Action	Controller Code
Set the instrument to generate an interrupt on receipt of a command error.	"*ESE 32;*SRE 32"
Force the generation of a command error by sending the non-existent device-dependent command XXX.	"XXX"

Input Channel Function Checks

- 16 Check each input in turn (A, B and C) by connecting a known frequency (within the band of each input) to the channel under test and checking the reading using the MEAS? command.
- 17 Test as follows:

Action	Controller Code
Set the instrument to the required channel and resolution, and request a measurement result.	"FRQA 10;MEAS?"

Read back the result and check that the result displayed on the controller is that of the signal frequency connected to the channel under test. Carry out the check on the other two channels.

INTRODUCTION

- 1 The instrument must be prepared for use and the functional check done in accordance with the instructions given in Section 3.

DESCRIPTION OF FRONT PANEL CONNECTORS AND INDICATORS

2

Reference	Item	Description
1	POWER Indicator (Green)	Lights when the instrument is switched on.
2	FAILED Indicator (Red)	Lights to indicate that the instrument has failed its self test.
3	ACTIVE Indicator (Amber)	Lights while data transfer between a VXI commander and the instrument is in progress.
4	GATE Indicator (Green)	Lights while a measurement cycle is in progress.
5	EXT. STANDARD INPUT 10MHz	A BNC female connector for connecting a 10 MHz external frequency standard.
6	INT STD ADJUST	This aperture provides access to allow adjustment of the internal frequency standard.
7	10 MHz STANDARD OUTPUT	A BNC female connector providing a 10 MHz signal locked to the frequency standard in use.
8	INPUT B Connector	BNC female fused connector for inputs from 40 MHz to 1300 MHz (2151) or Type 'N' female connector for 80 MHz to 2.6 GHz (2051).

Reference	Item	Description
9	INPUT A Connector	BNC female connector for inputs from 10 Hz to 100 MHz.
10	INPUT C Connector	PC 3.5 female connector for inputs from 0.5 GHz to 20 GHz (2151 only).
11	IF OUTPUT	A BNC female connector providing an I.F. output when making measurements on INPUT C. Output is continuously available in manual operation. In automatic operation the output is available during the gate time (2151 only).

DESCRIPTION OF SIDE PANEL SETTING CONTROLS

3

Reference	Item	Description
1	Logical Address Control	Two 16-position hexadecimal rotary switches. Sets the Logical address of the instrument, the available addresses are 1-254 (Hexadecimal 01 to FE).
2	Interrupt Level Control	Ten-position rotary switch. Sets the Interrupt Level, levels are 1 to 7. Do not set this switch to positions 8, 9 and 0.

4-2

2151 OPS
A1571/DA

INITIAL SWITCH-ON

- 4 Switch on the controller and other devices, including the 2151, and proceed with the functional check as described in Section 3 if this has not been done already.

NOTE: References within the operating instructions, i.e. (Ref. A1) or (Ref. B1), refer to command descriptions in TABLE 4.13a to TABLE 4.13d or TABLE 4.14a to TABLE 4.14k, in this section of the manual.

FREQUENCY MEASUREMENT - INPUT A

- 5 (1) Select Input A using the command "FRQA x", (Ref. B1).

NOTE: "x" is a number entered, in the range 3 to 10, to set the reading resolution. Gate time is related to the resolution selected. If omitted the previously set resolution will be used.

- (2) If a frequency below 50 kHz is to be measured in the presence of HF noise, select the low-pass input filter using the command "FILTA ON". The command "FILTA OFF" switches the filter off, (Ref. B9).

CAUTION: SIGNAL LEVEL

ENSURE THAT THE INPUT SIGNAL LEVEL DOES NOT EXCEED THE DAMAGE LEVELS SPECIFIED IN SECTION 1 OF THIS MANUAL.

- (3) If the x20 Attenuator is required, use the command "ATTENA ON". The command "ATTENA OFF" switches the attenuator off, (Ref. B8).
- (4) Connect the signal to be measured to INPUT A.
- (5) If HOLD mode operation is required, use the command "HOLD ON", (Ref. B11). To take a measurement, use the "MEAS?" or "*TRG" (Ref. A14) command.
- (a) "MEAS?" (Ref. B12) automatically places the result in the instrument's output queue ready for reading.
- (b) If "*TRG" (Ref. A14) is used, then send "DISP?" (Ref. B13) to place the reading in the output queue.

FREQUENCY MEASUREMENT - INPUT B

- 6 (1) Select Input B using the command "FRQB x", (Ref. B2).

NOTE: "x" is a number entered, between 3 and 10, to set the reading resolution. Gate time is related to the resolution selected. If omitted the previously set resolution will be used.

CAUTION: SIGNAL LEVEL

ENSURE THAT THE INPUT SIGNAL LEVEL DOES NOT EXCEED THE DAMAGE LEVELS SPECIFIED IN SECTION 1 OF THIS MANUAL.

NOTE: INPUT B is fused, see SECTION 1 of this manual.

- (2) Connect the signal to be measured to INPUT B.
- (3) If HOLD mode operation is required, use the command "HOLD ON", (Ref. B11). To take a measurement, use the "MEAS?" or "*TRG" command.
- (a) "MEAS?" (Ref. B12) automatically places the result in the instrument's output queue.
- (b) If "*TRG" (Ref. A14) is used, then send "DISP?" (Ref. B13) to place the reading in the output queue.
- (4) To return to continuous measurement mode send "HOLD OFF".

FREQUENCY MEASUREMENT - INPUT C (2151 ONLY)

Normal Automatic Mode

- 7 (1) Select Input C using the command "FRQC x", (Ref. B3).

NOTE: "x" is a number entered, see Technical Specification or Ref. B3, to set the reading resolution. Gate time is related to the resolution selected and the input frequency. If omitted the previously set resolution will be used.

CAUTION: SIGNAL LEVEL

ENSURE THAT THE INPUT SIGNAL LEVEL DOES NOT EXCEED THE DAMAGE LEVELS SPECIFIED IN SECTION 1 OF THIS MANUAL.

- (2) Connect the signal to be measured to INPUT C.
- (3) If HOLD mode operation is required, use the command "HOLD ON", (Ref. B11). To take a measurement, use the "MEAS?" or "*TRG" command.
- (a) "MEAS?" (Ref. B12) automatically places the result in the instrument's output queue.

- (b) If "*"TRG" (Ref. A14) is used, then send "DISP?" (Ref. B13) to place the reading in the output queue.
- (4) To return to continuous measurement mode send "HOLD OFF".

Manual Mode

- 8 In this mode the measured frequency, or a keyboard entered frequency value, is entered into the MANUAL Store, then MANUAL Mode is then selected, (Ref. B14).
 - (1) To store a center frequency (the example shows 19 GHz), send the command string "MAN 19E9".
 - (2) To store the frequency measurement, send the command string "MAN DISP".
 - (3) If Manual Mode was previously selected the new entered value of frequency is used immediately, otherwise, to enable Manual Mode send "MAN ON". The command "MAN OFF" switches the Manual Mode off, setting the instrument to normal automatic mode.

Further Functions in FREQ C (Automatic Mode Only)

- 9 In FREQ C, normal AUTOMATIC Mode, two more functions are available, these are LOW FM and TRACK.

NOTE 1:

These functions are not available in MANUAL Mode.

NOTE 2:

LOW FM and TRACK functions are mutually exclusive; only one of the functions being available at a time.

- 10 Selection of one function (e.g. TRACK), whilst the other function (LOW FM) is in use, will switch off the previously used function (LOW FM). Switching off the last used function (TRACK) will then return the instrument to AUTOMATIC Mode, NOT the previously used function.

Set LOW FM (FREQ C)

- 11 This function utilizes longer gate times to accommodate signals with low modulation rates, (Ref. B15).
- 12 To use this function proceed as follows:
 - (1) Proceed as described in 'FREQUENCY MEASUREMENT - INPUT C'.
 - (2) Send the command "LOWFM ON".
 - (3) To exit this function send "LOWFM OFF".

Set TRACK (FREQ C)

- 13 This function enables the instrument to measure swept frequencies, (Ref. B16).
- 14 To use this function proceed as follows:
- (1) Proceed as described in 'FREQUENCY MEASUREMENT - INPUT C'.
 - (2) Send the command "TRACK ON".
 - (3) To exit this function send "TRACK OFF".

RATIO MEASUREMENTS C/B (2151 ONLY), C/A (2151 ONLY) AND B/A

- 15 These three Ratio Modes use a 'software' ratio method, whereby the denominator is sampled first, followed by the numerator. The microprocessor in the instrument then computes the ratio.
- 16 For certain specific applications a 'hardware' version of RATIO B/A is available by enabling Special Function 91. This allows 'real time' ratio measurements to be made.
- (1) To select the relevant RATIO function, send the command "RACB x" (Ref. B7), "RACA x" (Ref. B6) or "RABA x" (Ref. B5).

NOTE: "x" is a number entered, in the range 3 to 10, to set the reading resolution. Gate time is related to the resolution selected. If omitted the previously set resolution will be used.

- (2) If INPUT A is being used:
 - (a) For a frequency below 50 kHz in the presence of HF noise, select the Low-Pass Input Filter ("FILTA ON"), (Ref. B9).
 - (b) If required select the Attenuator ("ATTENA ON"), (Ref. B8).

CAUTION: SIGNAL LEVEL
ENSURE THAT THE INPUT SIGNAL LEVEL DOES NOT EXCEED THE DAMAGE LEVELS SPECIFIED IN SECTION 1 OF THIS MANUAL.

NOTE: INPUT B is fused, see SECTION 1 of this manual.

- (3) If HOLD mode operation is required, use the command "HOLD ON", (Ref. B11). To take a measurement, use the "MEAS?" or "*TRG" command.
 - (a) "MEAS?" (Ref. B12) automatically enters the result in the instrument's output queue.
 - (b) If "*TRG" (Ref. A14) is used, then send "DISP?" (Ref. B13) to enter the reading in the output queue
- (4) To return to continuous measurement mode send "HOLD OFF".

MEASUREMENT SAMPLE RATE

- 17 On initial switch-on the instrument will sample signals at the optimum rate. However, the user can slow the sample rate down using the SAMPLE function, (Ref. B19). This sets the 'dead time' between readings and hence controls the sample rate.

Setting and Using the Sample Rate

- 18 To alter the sample rate, send the command "SAMPLE x", (Ref. B19). This enters the sample rate into the SAMPLE register and is used immediately.

NOTE: "x" is a number entered to set the maximum sample rate. If zero is entered, the counter will run at maximum speed compatible with the system set-up.

Interrogating the Sample Rate

- 19 To display the sample rate at the controller, send the command string "SAMPLE?", (Ref. B26).

MULT FUNCTION

- 20 This function is used to display (at the controller) the input signal multiplied by the number held in the MULT (Multiply) register, (Ref. B18). This function can be used, for instance, to display the true frequency reading of a signal source that has been divided or multiplied before being sampled by the instrument.

Setting the Multiplier

- 21 To store a multiplier for later use, send the command "MULT x", (Ref. B18).

NOTE: "x" is a number entered to set the multiplier.

Enabling the Multiplier

- 22 To enable the stored multiplier, send the command "MULT ON", (Ref. B18).

- 23 To disable the MULT function send "MULT OFF".

Interrogating the Multiplier

- 24 If necessary the stored multiplier can be displayed at the controller by sending the command "MULT?", (Ref. B25).

OFFSET FUNCTION

- 25 This function can be used to add or subtract a value to the measured frequency, (Ref. B17). It is also used to subtract the displayed frequency (nulling) to view drift or offset. For example: measuring the IF of a radio receiver, after entering the receiver local oscillator frequency as a positive offset, enables the true input frequency to be displayed.

Setting the Offset

- 26 If enabled, the offset frequency entered is normally subtracted from the measured signal frequency.
- (1) To store the offset frequency, send the command string (this example shows 10.5 MHz), "OFFSET +/-10.5E6", (Ref. B17). This enters the offset frequency into the OFFSET register.
 - (2) To store the measured frequency as an offset, send the command string "OFFSET DISP", (Ref. B17).

Enabling the Offset

- 27 To enable the stored offset, send the command string "OFFSET ON". The OFFSET function is disabled by sending "OFFSET OFF", (Ref. B17).

Interrogating the Offset

- 28 If necessary the stored offset can be displayed at the controller by sending the command "OFFSET?", (Ref. B24).

SMOOTH FUNCTION

- 29 Selecting SMOOTH enables the instrument to take a 'running average' of the input frequency and display at the controller those digits that are stable. Place holding zeros are inserted in place of unstable digits.
- 30 To enable the SMOOTH function send the command "SF 21,ON". The function is disabled by sending "SF 20".

CLK10 FREQUENCY STANDARD

- 31 The CLK10 Frequency Standard can be selected in preference to the external standard, or the instruments own internal standard (whichever standard is in use at the time).
- 32 To select CLK10 send the command "CLK10 ON". Sending "CLK10 OFF" reverts the system to the original frequency standard by switching the CLK10 standard off, (Ref. B10).

GATE TIME

33 For INPUTs A and B, Gate Time is related to the resolution selected, as shown in TABLE 4.1a.

TABLE 4.1a

Gate Times for FREQUENCIES A and B

Number of digits in FREQ A, FREQ B & CHECK	Gate Time	Resolution Number
10	20 s	10
9	1 s	9
8	100 ms	8
7	10 ms	7
6	1 ms	6
5	1 ms	5
4	1 ms	4
3	1 ms	3

34 For INPUT C, Gate Time is related to both the resolution selected and the input frequency, as shown in TABLE 4.1b.

TABLE 4.1b

Gate Times for FREQUENCY C

Frequency GHz	1 Hz	Resolution		
		10 Hz	100 Hz	1 kHz
0.5- 1.0	100 ms	10 ms	1 ms	1 ms
1.0- 4.0	200 ms	20 ms	2 ms	1 ms
4.0- 8.0	400 ms	40 ms	4 ms	1 ms
8.0-12.0	600 ms	60 ms	6 ms	1 ms
12.0-16.0	800 ms	80 ms	8 ms	1 ms
16.0-20.0	1 s	100 ms	10 ms	1 ms

SPECIAL FUNCTIONS

35

The special functions provided for use by the operator are listed in TABLE 4.2 Major Special Functions, and TABLE 4.3 Minor Special Functions. The major special functions are those most commonly used by the operator. Each special function is defined by a two-digit number.

TABLE 4.2

Major Special Function

Function	Code
Cancels Smooth function	20
Selects Smooth function (See NOTE 1)	21
Leading (function) letters in O/P string	80
No leading (function) letters in O/P string	81
Cancels group 90 special functions	90
Enables hardware ratio B/A	91

TABLE 4.3

Minor Special Function

Function	Code
Deselects Channel A filter	10
Selects Channel A filter	11
Cancels all group 30 special functions	30
Displays Local Oscillator Value (See NOTE 2)	31 *
Displays Intermediate Frequency (See NOTE 3)	32 *
Displays Harmonic Number as an integer (See NOTE 3)	33 *
Displays Harmonic Number with fractional part (See NOTE 3)	34 *
Displays IF Detector Status (See NOTES 3 & 4)	35 *
Cancels all group 40 special functions	40
Allows setting of LO & Harmonic Number (See NOTES 3 & 5)	41
Switches LO Off under all conditions (Quiet Mode)	42
Cancels all group 50 special functions	50
Ignore IF level detector	51
Deselects Channel A attenuator	60
Selects Channel A attenuator	61
Basic 10 MHz check	70
Exercise front panel displays and LEDs	71 *
Start TEC, short calibration value	72
Start TEC, long calibration value	73
Stop TEC, short calibration value	74
Stop TEC, long calibration value	75

* Function applicable only with 'Service Front Panel' connected, see Maintenance Manual.

NOTE 1:

This function does not operate on diagnostic special functions.

NOTE 2:

This function only operates during INPUT C measurements and displays the Local Oscillator selected to make a measurement.

NOTE 3:

Operates under same conditions as Special Function 31.

NOTE 4:

"0" displayed = Detector False.

"1" displayed = Detector True.

(Special Function 41 must also be active).

NOTE 5:

LO and Harmonic Number (HN) store both active.

NOTE 6:

Special Functions 30, 40 and 50 are only available on 2151.

Setting the Special Function Register

- 36 When a special function is to be used, its number must first be entered into the register. To do this send the command string:

"SF NN", (Ref. B34).

Where NN is the special function number to be entered. The instrument returns to the measurement mode automatically once the number is stored.

- 37 When a number is stored, it overwrites the previously stored number in the same decade. To remove a number from the register, another number must be stored.

Enabling and Disabling the Special Functions

- 38 The group of special functions whose numbers are entered in the special function register are enabled by sending the command "SF ON". The special functions are disabled by sending "SF OFF".

- 39 The default state corresponds to the default state of the special function register, i.e., with special functions 10, 20, 30, 40, 50, 60, 70, 80 and 90 enabled.

NOTE:

A special function entered in the register while the special functions are enabled will be enabled immediately.

ERROR CODES

40

The instrument is able to detect a number of error states, which are indicated on the controller. The meanings of the error codes are shown in TABLE 4.4.

TABLE 4.4
Error Messages

Error	Meaning
Op Er	Operator error caused by 'illegal' entries or attempt to enter a value out of range.
Er 02	Measurement result too large, or small, to display.
Er 03	Overflow of internal counters.
Er 50	Incorrect result obtained when in CHECK mode.
Er 51	Local oscillator out of lock (2151 only).
Er 60	EPROM paging failure.
Er 61	RAM failure.

NOTE:

Op Er, Er 60 and Er 61 are applicable only when the Service Front Panel is connected to the instrument, see Maintenance Manual.

Clearing the Error Codes

41

Error codes are cleared as follows:

- (1) Op Er, Er 02 and Er 03: Clear by sending the reset command or if the Service Front Panel is connected, press RESET key.
- (2) Er 50, Er 51, Er 60 and Er 61: These are equipment failure errors, switch off instrument and return it for repair.

VXI OPERATING MODES

- 42 The instrument can be operated via the VXI using the 'BYTE AVAILABLE' and 'BYTE REQUEST' VXI commands.

READING OUT DATA

- 43 The rate at which measurements are made is determined by the instrument. The output buffer is updated at the end of each measurement cycle, overwriting the previous measurement data if this has not been transferred to the controller.

- 44 The transfer of data from the instrument to the controller is triggered by the controller. The instrument's output buffer is cleared when the data transfer is complete. Problems arising from the differences between the measurement rate and data transfer trigger rate are resolved according to the following protocol:

- (1) If data transfer is in progress at the end of a measurement cycle, the updating of the output buffer is delayed. The data transferred will relate to the previous measurement cycle.
- (2) If the data transfer trigger occurs during a measurement cycle and the output buffer is empty, data transfer will be delayed until the buffer is updated. The data transferred will then relate to the latest measurement cycle.
- (3) If a measurement cycle is completed before the results of the previous cycle have been transferred to the controller, the buffer will be updated. The data for the previous cycle will be overwritten and lost.

- 45 The rate at which measurements are made can be controlled in the following ways:

- (1) The gate time of the instrument (duration of the measurement cycle) can be controlled by choosing an appropriate resolution.
- (2) The instrument can be operated in the HOLD mode. Single measurement cycles can be triggered, when required, by means of the *TRG or MEAS? commands.
- (3) The instrument hold time can be set by entering a value, in seconds, into the sample store from the controller.

- 46 The format of the data output is described in TABLE 4.5.

CONTROLLING THE INSTRUMENT

- 47 All the instruments functions are controlled by means of device-dependent commands, sent via the bus, using the 'BYTE AVAILABLE' VXI command.

48 The measurements made, and data regarding the instrument's status, can be read via the bus with the 'BYTE REQUEST' command.

DATA OUTPUT FORMAT - NORMAL

49 The same output message format is used for the transmission of measured values and numbers recalled from the instrument's internal stores. The message consists of a string of 21 ASCII characters for each value transmitted. These are to be interpreted as shown in TABLE 4.5. The units should be assumed to be Hz, seconds, or a ratio, depending upon the commands previously given to the instrument.

DATA OUTPUT FORMAT - DUMP MODES

50 Dump mode output format is in the same output message format as normal data outputs. Reading resolution is decreased thus decreasing computing and output time to allow for faster sample rates. Resolution of the readings is limited in the following ways:

- (1) FREQ. C readings restricted to 10 kHz resolution.
- (2) FREQ. A and FREQ. B readings restricted to four digits resolution.

51 Certain other modes are forced in Dump mode, see TABLE 4.14g. Refer to TABLE 4.7 and 4.8 for Dump mode byte functions.

TABLE 4.5

Output Message Format

Byte No.	Interpretation	Permitted ASCII Characters
1	Function Letter	See TABLE 4.6
2	Function Letter	See TABLE 4.6
3	Space	Missing if SF81 is active
4	Sign of measurement	+ or -
5	Most Significant Digit	0 to 9 or .
6	Digit	0 to 9 or .
7	Digit	0 to 9 or .
8	Digit	0 to 9 or .
9	Digit	0 to 9 or .
10	Digit	0 to 9 or .
11	Digit	0 to 9 or .
12	Digit	0 to 9 or .
13	Digit	0 to 9 or .
14	Digit	0 to 9 or .
15	Digit	0 to 9 or .
16	Digit	0 to 9 or .
17	Least Significant Digit	0 to 9 or .
18	Exponent Indicator	E
19	Sign of exponent	+ or -
20	More Significant Digit	0 to 9
21	Least Significant Digit	0 to 9
22	New Line (NL)	Also known as LF (Linefeed). 'END' is sent with NL.

NOTE 1:

Bytes 5 to 17 will always include 13 digits and a decimal point. Zeros will be added, where necessary, in the more significant digit positions.

NOTE 2:

The exponent indicated by bytes 20 and 21 will always be a multiple of three.

TABLE 4.6

Function Letters

Function	Function Letters
Frequency A	FA
Frequency B	FB
Frequency C	FC
Check	CK
Ratio C/B	CB
Ratio C/A	CA
Ratio B/A	BA
Recalled Data	Function Letters
Resolution	RS
Manual Store	MN
Offset Store	OS
Mult. Store	MU
Sample Rate Store	SA
Harmonic Number	HN
Local Oscillator Frequency	LO

NOTE: Bytes 1, 2 and 3 are not sent when special function 81 is active.

TABLE 4.7**Frequency C Dump**

Byte	Character	Function
1	0 to 9	GHz x 10
2	0 to 9	GHz
3	0 to 9	MHz x 100
4	0 to 9	MHz x 10
5	0 to 9	MHz
6	0 to 9	kHz x 100
7	0 to 9	kHz x 10
8	0 to 9	kHz (See NOTE)

NOTE:
END sent with this byte.

TABLE 4.8**Frequency A and B Dump**

Byte	Character	Function
1	0 to 9	Most significant digit (see NOTE 1)
2	0 to 9	Digit
3	0 to 9	Digit
4	0 to 9	Digit
5	0 to 9	Digit
6	0 to 9	Digit
7	0 to 9	Least significant digit
8	E	Exponent
9	0 to 9	Exponent Value (see NOTE 2)

NOTE 1:
Implied decimal point position is before Byte 1.

NOTE 2:
END sent with this byte.

REQUESTING SERVICE

- 52 The instrument can be set, by means of device-dependent commands, to request service from the controller by sending an interrupt request (IRQ).
- (1) A response message is ready.
 - (2) A VXIbus defined error occurs.
 - (3) A device defined error occurs.
 - (4) A change of frequency standard occurs.
- 53 The generation of the IRQ may also be inhibited. Generation of all IRQs is disabled when the instrument is first switched on.

STATUS BYTE

- 54 The format of the status byte, generated in response to a 'READ STB' command, is given in TABLE 4.10.

SETTING THE ENABLE REGISTERS

- 55 The Enable Registers to be set up are as follows:
- (1) Service Request Enable Register - set using *SRE.
 - (2) Standard Event Status Enable Register - set using *ESE.
 - (3) Device Defined Event Status Enable Register - set using ESE.
- 56 Each bit in an enable register set to logic '1' enables the equivalent bit in its associated service register, see Table 4.9 for Associated Registers.

Table 4.9

Associated Registers

Enable Register	Service Register
Service Request Enable Register	Status Byte Register
Standard Event Status Enable Register	Standard Event Status Register
Device Defined Event Status Enable Register	Device Defined Event Status Register

57 The enable registers are set up by entering the register enable codes in NR1 format. NR1 format comprises decimal numbers in the range 0 to 255 representing the binary codes entered into the enable registers. See TABLE 4.10 to TABLE 4.12 for register contents.

58 The following example illustrates a register bit setting code and the NR1 format entry.

59 Example:

DIO Line Number: 8 7 6 5 4 3 2 1

Bit Number: 7 6 5 4 3 2 1 0

Required Bit Setting: 0 0 1 0 0 1 1 0

Binary Code: 100110

NR1 Format Decimal Number

Code to be entered: 38

60 NR1 format codes can be entered as single digit numbers, two digit numbers or three digit numbers; e.g. 38, 038, 005, 05, 5, 120 etc.

TABLE 4.10

Status Byte and Service Request Enable Registers

DIO Line	Bit	Function
1	0	Not used - always logic 0
2	1	Not used - always logic 0
3	2	Not used - always logic 0
4	3	'1' = Summary of Device Event Status Register showing one or more logic 1s
5	4	'1' = Response message available
6	5	'1' = Summary of Standard Event Status Register showing one or more 1s
7	6	'1' = Service requested
8	7	Not used - always logic 0

TABLE 4.11

Standard Event Status and Enable Registers

DIO Line	Bit	Function
1	0	'1' = Operation Complete
2	1	Not used - always logic 0
3	2	'1' = Query Error (see NOTE 1)
4	3	Not used - always logic 0
5	4	'1' = Execution Error (see NOTE 2)
6	5	'1' = Command Error (see NOTE 3)
7	6	Not used - always logic 0
8	7	'1' = Power On (after power interrupt)

NOTE 1:

Error generated either if controller tries to read the Output Queue when no output is available or data in the Output Queue is lost.

NOTE 2:

Error generated either if data associated with a particular command header is out of range, of the wrong type for a particular command, or if a valid program message could not be executed.

NOTE 3:

Command Error can be as a result of one of the following:

- (1) Syntax error.
- (2) Device has received an unrecognized or unimplemented header.
- (3) 'GET' message has occurred within a program message.
- (4) The command string will be correctly executed up to the point the error occurs. The remaining string up to the next command separator (;), or a valid program message terminator, will be ignored. Execution will continue as normal after reception of either of these delimiters.

TABLE 4.12

Device Defined Event Status and Enable Registers

DIO Line	Bit	Function
1	0	'1' = Indicates change of standard
2	1	'1' = Indicates Channel B overload
3	2	Not used - always logic 0
4	3	'1' = Result out of range (see NOTE 1)
5	4	'1' = Internal counters overflow (see NOTE 2)
6	5	'1' = Local Oscillator out of lock (see NOTE 3).
7	6	'1' = Check mode error (see NOTE 4)
8	7	Not used - always logic 0

NOTE 1:
ER 02 generated.

NOTE 2:
ER 03 generated.

NOTE 3:
ER 04 generated (2151 only).

NOTE 4:
ER 50 generated.

MESSAGE PROTOCOL AND SYNTAX

- 61 The VXIbus protocol provides a communication medium, using different types of messages, between a controller and controlled devices (i.e. Measuring instruments such as the 2151 Microwave Counter). This medium is passed between controller and device via the VXI Interface Bus and the controllers own communication medium (e.g. Ethernet, GPIB or RS232).
- 62 The IEEE 488.2 Standard lays down further hard and fast rules for message construction and content (referred to as PROTOCOL and SYNTAX).

System Message Traffic

- 63 Messages passed between controller and device consist of the following types:
- (1) Program Messages - passed from controller to device. Program messages contain commands telling the device to do something, queries asking the device for data and status information, and data for setting device operating parameters.
 - (2) Response Messages - Passed from device to controller. Response messages contain responses to queries and commands, data containing error information and results from measurements taken.

- 64 An example of a command is shown as follows:

Controller sends the command:	Device interprets and acts upon the command by selecting:
'FRQA'	'FRQA'

- 65 An example of a query is shown as follows:

Controller sends the query:	Device responds by sending the answer to the controller:
'GATE?'	'1' (indicating that the gate is open)

NOTE: In this example the device has first acted as a listener to enable it to receive the query, then acted as a talker to send the answer back to the controller as a response message.

Program Messages

- 66 Program messages are made up of Program Message Units (PMUs), PMU Separators (;) and a Program Message Terminator (PMT), see TABLE 4.15 Permitted Terminators. A program message may include up to ten PMUs and is constructed as follows:

PMU ; PMU ; PMU ; PMU ; PMU PMT

67 Each PMU within the message is made up of a PMU Header (a mnemonic of ASCII characters), a Header separator (a white space character), Data and Data separators (.). A PMU is constructed as follows:

```
HEADER[ ]DATA , DATA , DATA , DATA , DATA ;
```

NOTE: In this example the white space character is represented by square brackets []. Text spaces shown in the preceding and following examples are included for clarity only, no spaces in messages are to be used except where indicated by the square brackets.

This device accepts Program Messages into a buffer that can hold 10 string characters or 20 numerical characters.

Response Messages

68 Response messages are constructed in a similar manner to program messages. Response messages consist of Response Message Units (RMUs), RMU Separators (;) and a Response Message Terminator (RMT). The RMT is always the NL (or LF) character with END. A response message is constructed as follows:

```
RMU ; RMU ; RMU ; RMU ; RMU RMT
```

69 This device can store, in the Output Queue, five Response Message Units.

71 Each RMU within the message is made up of a RMU Header (a mnemonic of ASCII characters), a Header separator (a white space character), Response Data and Response Data separators (.). A RMU is constructed as follows:

```
HEADER[ ]RESPONSE DATA , RESPONSE DATA , RESPONSE DATA ;
```

NOTE: In this example the white space character is represented by square brackets [].

White Space Character

71 The white space character may be any ASCII encoded byte in the ranges of 0 to 9 and 11 to 32 inclusive. The most commonly used white space character is the space character (ASCII encoded byte 32) as generated by a QWERTY keyboard space bar.

OVERLAPPED/SEQUENTIAL COMMANDS

72 Every device-dependent command is defined as either sequential or overlapped.

73 A sequential command is started and completed before the succeeding command is executed.

74 An overlapped command is started but not necessarily completed before the succeeding command is started.

75 The synchronization commands [*WAI (Ref. A6), *OPC (Ref. A4), *OPC? (Ref. A5)] can be used to either control or indicate when the commands have been completed.

COMMANDS

76 Each entry represents a complete Program Message Unit (PMU). A program string may contain more than one PMU separated by the PMU separator (;).

77 In the listed commands the boxes have the following meanings:

- (1) Capital letters represent mnemonics.
- (2) 'chs' represents a command header separator (whitespace character).
- (3) 'ds' represents a data separator (,).
- (4) 'num' represents a numerical data entry in NR1, NR2 or NR3 format.
- (5) 'DISP' represents the current reading.

TABLE 4.13a

Common Commands

Ref. A1 - Identification Query



Puts into the Output Queue a unique identification of the device. Response is divided into four fields separated by commas:

Field 1 - Manufacturer

Field 2 - Model number

Field 3 - ASCII character 0

Field 4 - Software details

NOTE:

This Query should be the last Query message in any terminated message.

Ref. A2 - Reset

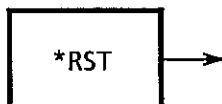

Sets device dependent functions to their power-up state. Also forces the OCIS and OQIS states.

TABLE 4.13b

Common Commands (Continued)

Ref. A3 - Self Test Query



Performs all tests not needing operator intervention. If all checks pass then ASCII value 0 is placed in the Output Queue. If checks fail then the relevant number is placed in the Output Queue. The number output is in NR1 format.

Ref. A4 - Operation Complete



Causes the instrument to generate the operation complete message in the Standard Event Status Register when all pending selected device operations are completed.

Ref. A5 - Operation Complete Query



As *OPC, but places an ASCII value 1 into the Output Queue instead of setting the Operation Complete message. This is in NR1 format.

Ref. A6 - Wait to Continue



The instrument is prevented from executing any further commands or queries until there are no further operations pending.

Ref. A7 - Clear Status Command

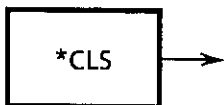

Clears the status reporting registers.

TABLE 4.13c

Common Commands (Continued)

Ref. A8 - Standard Event Status Enable

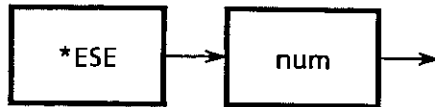

Sets the Standard Event Status Enable Register bits. This register determines which standard events will be reported to the Status Byte Register. Allowed range is 0 to 255, any unused bits will not be set.

Ref. A9 - Standard Event Status Enable Query



Places the contents of the Standard Event Status Enable Register into the Output Queue. This is in NR1 format.

Ref. A10 - Standard Event Status Register Query

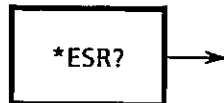

Places the contents of the Standard Event Status Register into the Output Queue. This is in NR1 format.

Ref. A11 - Service request Enable Command

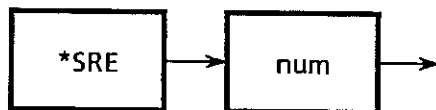

Sets the Service Request Enable Register bits. Each bit summarizes either a queue or status register. Each bit, when enabled, will cause an interrupt when the corresponding queue becomes non-zero or any hit becomes true in a status register. Allowed range of data is 0 to 255, any unused bits will not be set.

Ref. A12 - Service Request Enable Query

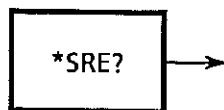

Causes the instrument to place the contents of the Service Request Enable Register into the Output Queue. This is in NR1 format.

TABLE 4.13d

Common Commands (Continued)

Ref. A3 - Status Byte Query



Causes the instrument to place the contents of the status byte into the Output Queue. NR1 format. This returns the same value as a serial poll with the exception of bit 6 which is the Master Summary Status bit. NR1 format.

Ref. A14 - Trigger Command



Causes the instrument to trigger a measurement. Any existing measurement is aborted.

TABLE 4.14a

Device Dependent Commands

Measurement Functions

Ref. B1 - Frequency A

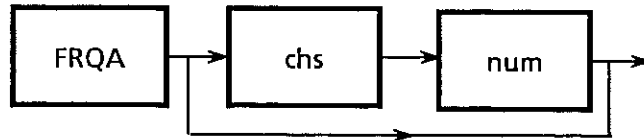

Selects Channel A input. Optional number (num) data, in the range of 3 to 10, is the resolution required. If this data is missing then the previous resolution will be used.

Ref. B2 - Frequency B

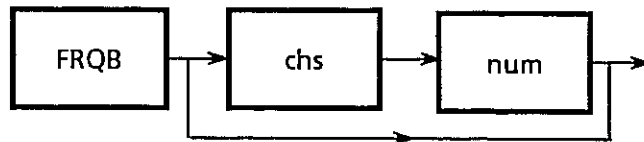

Selects Channel B input. Optional number (num) data, in the range of 3 to 10, is the resolution required. If this data is missing then the previous resolution will be used.

Ref. B3 - Frequency C (2151 only)

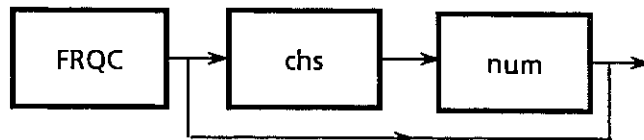

Selects Channel C input. Optional number (num) data, expressed as a frequency in Hz, kHz, MHz or GHz, rounded to the nearest decade, is the resolution required. If this data is missing then the previous resolution will be used. The range allowed is 0.1 Hz to 10 kHz.

Ref. B4 - Check

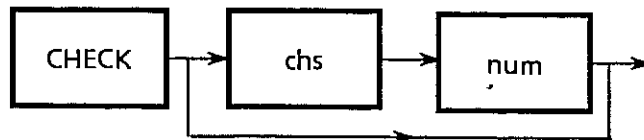

Selects 10 MHz check. Optional number (num) data, in the range of 3 to 10, is the resolution required. If this data is missing then the previous resolution will be used.

TABLE 4.14b

Device Dependent Commands (Continued)

Ref. B5 - Ratio B/A

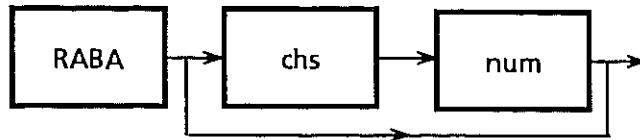

Selects the ratio of Channel B to Channel A. Optional number (num) data, in the range of 3 to 10, is the resolution required. If this data is missing then the previous resolution will be used.

Ref. B6 - Ratio C/A (2151 only)

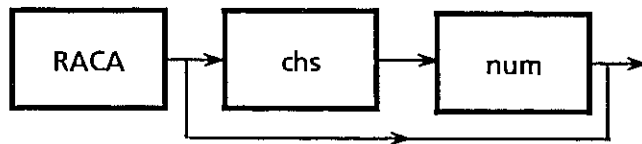

Selects the ratio of Channel C to Channel A. Optional number (num) data, in the range of 3 to 10, is the resolution required. If this data is missing then the previous resolution will be used.

Ref. B7 - Ratio C/B (2151 only)

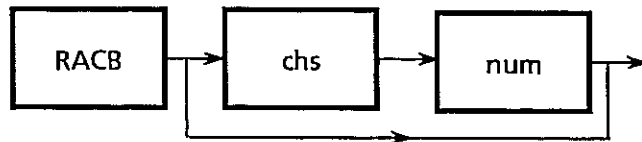

Selects the ratio of Channel C to Channel B. Optional number (num) data, in the range of 3 to 10, is the resolution required. If this data is missing then the previous resolution will be used.

Hardware Control

Ref. B8 - Channel A Attenuator Control

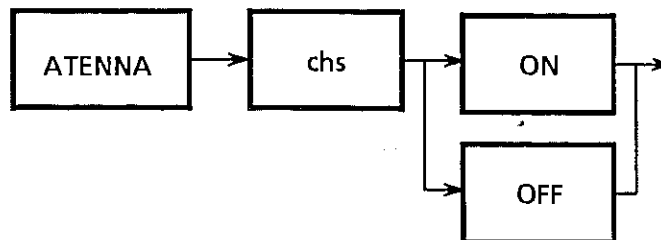

Controls the Channel A x20 attenuator. 'ON' switches in the attenuator and 'OFF' switches it out.

TABLE 4.14c

Device Dependent Commands (Continued)

Ref. B9 - Channel A Filter Control

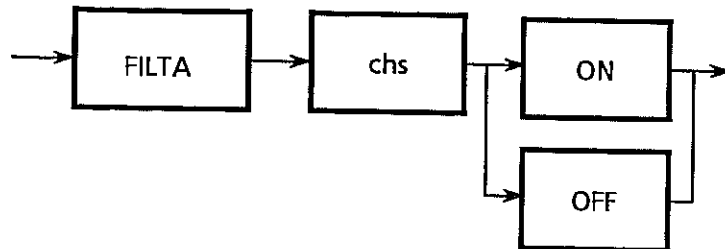

Controls the Channel A low-pass filter. 'ON' switches in the filter and 'OFF' switches it out.

Ref. B10 - Reference Selection Control

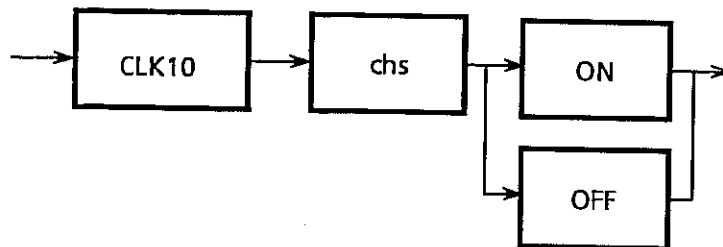

Controls the selection of either the CLK10 reference or the counter reference. 'ON' selects CLK10, 'OFF' selects the counter reference.

Measurement Control

Ref. B11 - Hold

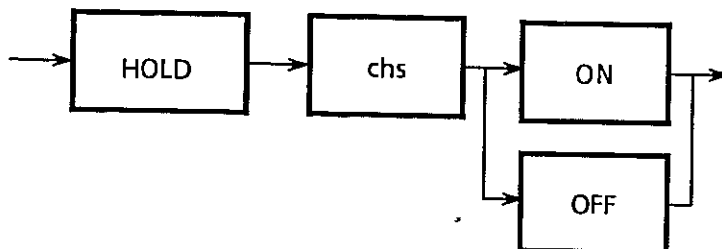

Selects the HOLD mode, suspending repetitive measurements. The reading is held until another is triggered (see *TRG and MEAS?).

TABLE 4.14d

Device Dependent Commands (Continued)

Ref. B12 - Measurement

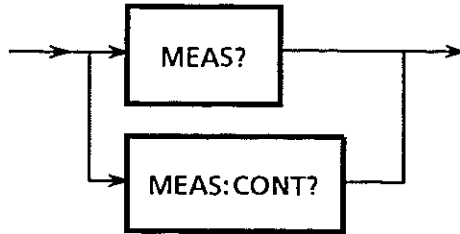

The upper path of this command causes the instrument to abandon any current reading, start a new cycle and place the calculated result into the Output Queue. The lower path is similar, but as soon as the result is read out of the Output Queue a new measurement is taken and placed into the Output Queue.

Results are delimited by the comma (data separator) with the string length infinitely long, i.e. no terminator is sent. Sending any device command will terminate this action and set the Query Error (as required by IEEE 488.2) bit in the Standard Event Register.

Ref. B13 - Displayed Measurement



This command places the current result into the Output Queue. If this command is repeated without another measurement taking place, or the counter is reset, then a zero will be placed into the Output Queue.

NOTE:

This command is used in conjunction with *TRG, or GET in the HOLD mode. If the HOLD mode is off, then the result of the *TRG or GET command will be lost.

TABLE 4.14e

Device Dependent Commands (Continued)

Ref. B14 - Manual/Auto Acquisition (2151 only)

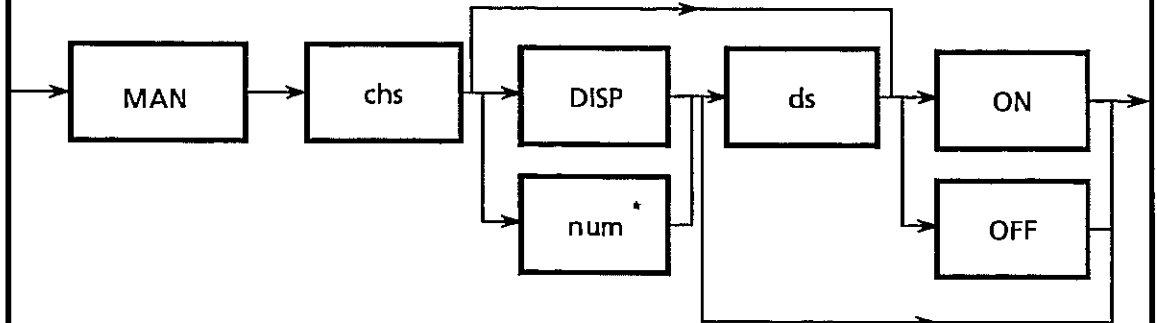

Controls the manual acquisition mode. Two parameters can be specified, these are the value to be entered in the Manual Store and switching Manual Mode ON or OFF. At least one parameter must be entered or a command error is generated.

NOTE:

Selecting MAN ON will automatically disable TRACK ON or LOWFM ON commands. When MAN OFF is selected TRACK and LOWFM revert to their previous state.

* num value : 495 MHz to 26.505 GHz

Ref. B15 - Low FM Acquisition Mode (2151 only)

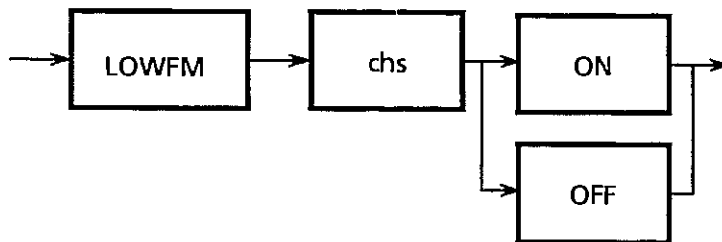

This selects LOWFM when in the automatic acquisition mode. Selecting LOWFM ON while in manual acquisition mode generates an execution error. TRACK ON is disabled if this mode is selected, selecting LOWFM OFF does not reset TRACK to ON.

TABLE 4.14f

Device Dependent Commands (Continued)

Ref. B16 - Track Acquisition Mode (2151 only)

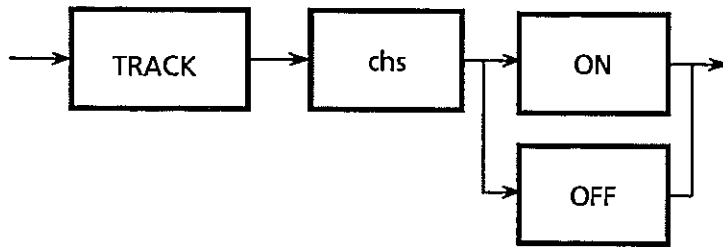

This selects TRACK when in the automatic acquisition mode. Selecting LOWFM ON while in manual acquisition mode generates an execution error. LOWFM ON is disabled if this mode is selected, selecting TRACK OFF does not reset LOWFM to ON.

Ref. B17 - Offset

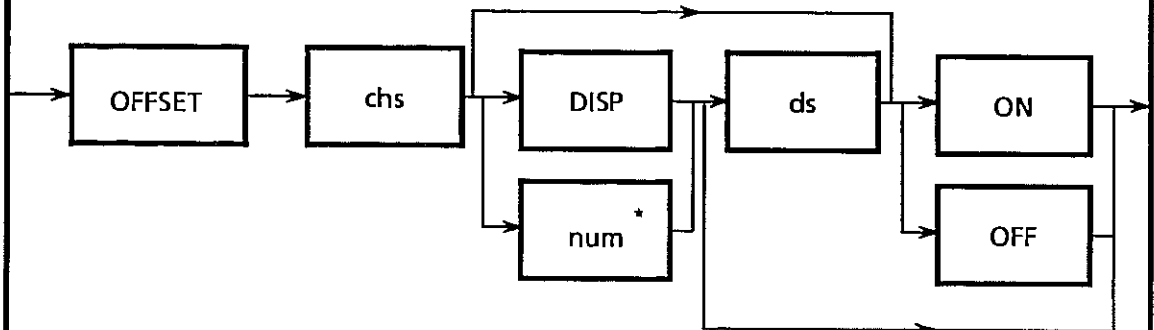

This controls the offset mathematics function. Two parameters can be specified, these are the value to be entered in the offset store (of which there are two sources), and turning the function ON or OFF. If no parameters are specified, then a command error is generated.

Ref. B18 - Multiplier

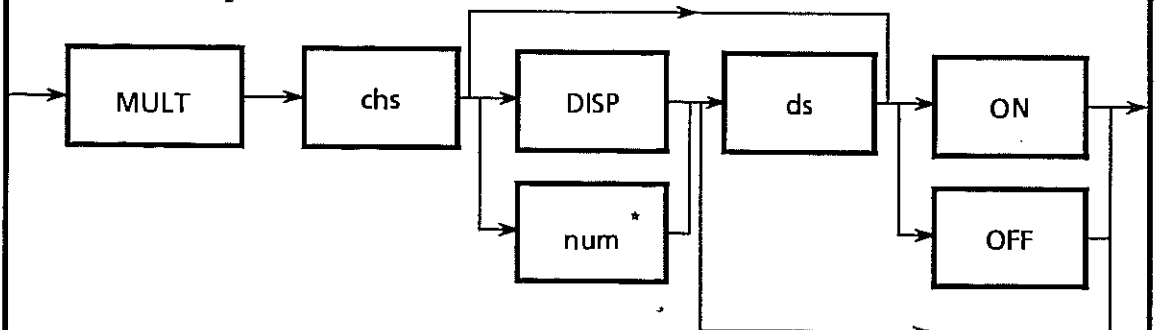

This controls the multiplier mathematics function. Two parameters can be specified, these are the value to be entered in the multiplier store (of which there are two sources), and turning the function ON or OFF. If no parameters are specified, then a command error is generated.

* num value : $\pm 999.9999999999 e^{12}$

TABLE 4.14g

Device Dependent Commands (Continued)

Ref. B19 - Sample Rate



This sets the maximum sample rate. If zero is entered then the counter will run at its maximum possible speed compatible with the current set-up.

Ref. B20 - Dump Mode (See also NOTE 1)

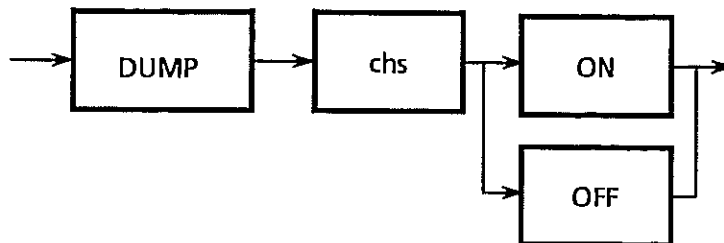

This selects Dump Mode. The following modes must be set before dump mode is activated:

- (1) FRQA, FRQB at six digits resolution, or FRQC at 1 kHz resolution.
- (2) MULT, OFFSET and SMOOTH OFF.
- (3) LOWFM OFF.

Ref. B21 - Local Oscillator Setting (2151 only)

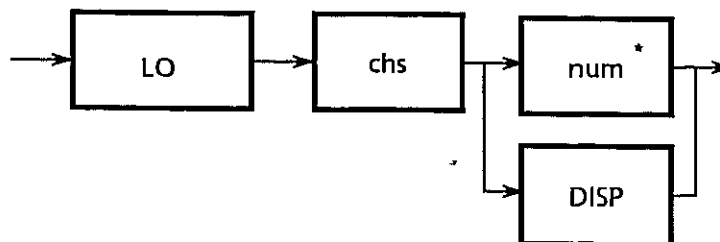

This sets the value of the Local Oscillator to be used when SF 41 is active.

* num value : 292 MHz to 355 MHz

TABLE 4.14h

Device Dependent Commands (Continued)

Ref. B22 - Harmonic Number Setting (2151 only)

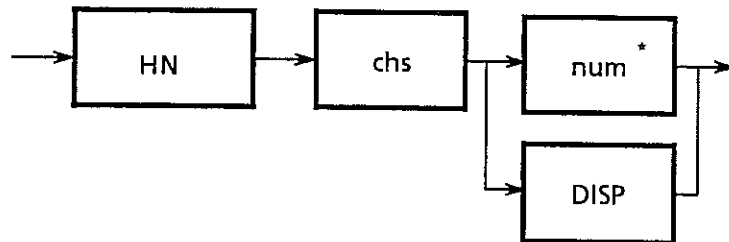

This sets the value of the Harmonic Number to be used when SF 41 is active.

* num value : -59 to +59

Query Commands

Channel A Attenuator

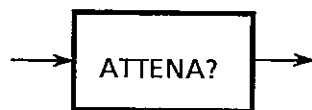

Places a numerical value in the Output Queue according to the state of the channel A attenuator:

1. '1' indicates attenuator ON
2. '0' indicates attenuator OFF

NR1 format

Channel A Low Pass Filter

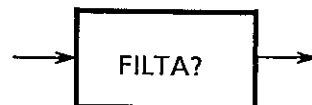

Places a numerical value in the Output Queue according to the state of the channel A low pass filter:

1. '1' indicates filter ON
2. '0' indicates filter OFF

TABLE 4.14i

Device Dependent Commands (Continued)

NR1 format

Special functions

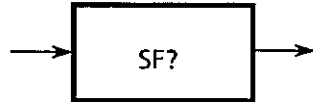

Places a string of 10, NR1 format, digits separated by commas (,) into the Output Queue. See Table 4.17 for response format.

Ref. B23 - Manual Store (2151 only)



Places the contents of the manual store into the Output Queue. NR3 format.

Ref. B24 - Offset Store



Places the contents of the offset store into the Output Queue. NR3 format.

Ref. B25 - Multiplier Store

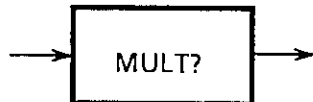

Places the contents of the multiplier store into the Output Queue. NR3 format.

Ref. B26 - Sample Store

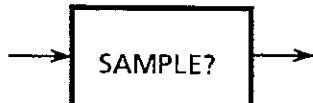

Places the contents of the sample store into the Output Queue. NR3 format.

TABLE 4.14j

Device Dependent Commands (Continued)

Ref. B27 - Standard in Use



Places a numerical value in the Output Queue according to the standard in use:

- (1) '1' represents internal standard,
- (2) '0' represents external standard.

This is in NR1 format.

Ref. B28 - Device Event Status Register



Places the contents of the Device Defined Event Register into the Output Queue. NR1 format.

Ref. B29 - Device Event Status Enable Register



Places the contents of the Device Defined Event Status Enable Register into the Output Queue. NR1 format.

Ref. B30 - Gate



Places a numerical value in the Output Queue according to the status of the gate signal:

- (1) '1' indicates gate open,
- (2) '0' indicates gate closed.

This is in NR1 format.

TABLE 4.14k

Device Dependent Commands (Continued)

Ref. B31 - Local Oscillator Store (2151 only)



Places the contents of the local oscillator store, used by SF 41, in the Output Queue. NR1 format.

Ref. B32 - Harmonic Number Store (2151 only)

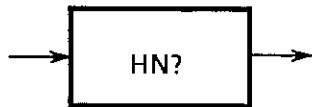

Places the contents of the harmonic number store, used by SF 41, in the Output Queue. NR1 format.

Special Function

Places the content of the special function number store in the Output Queue.

Status

Ref. B33 - Device Event Status Enable Register

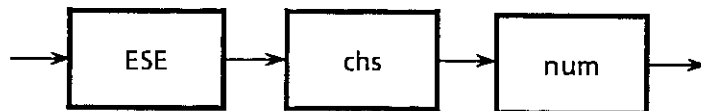

Sets the Device Defined Event Status Register.

TABLE 4.14I

Device Dependent Commands (Continued)

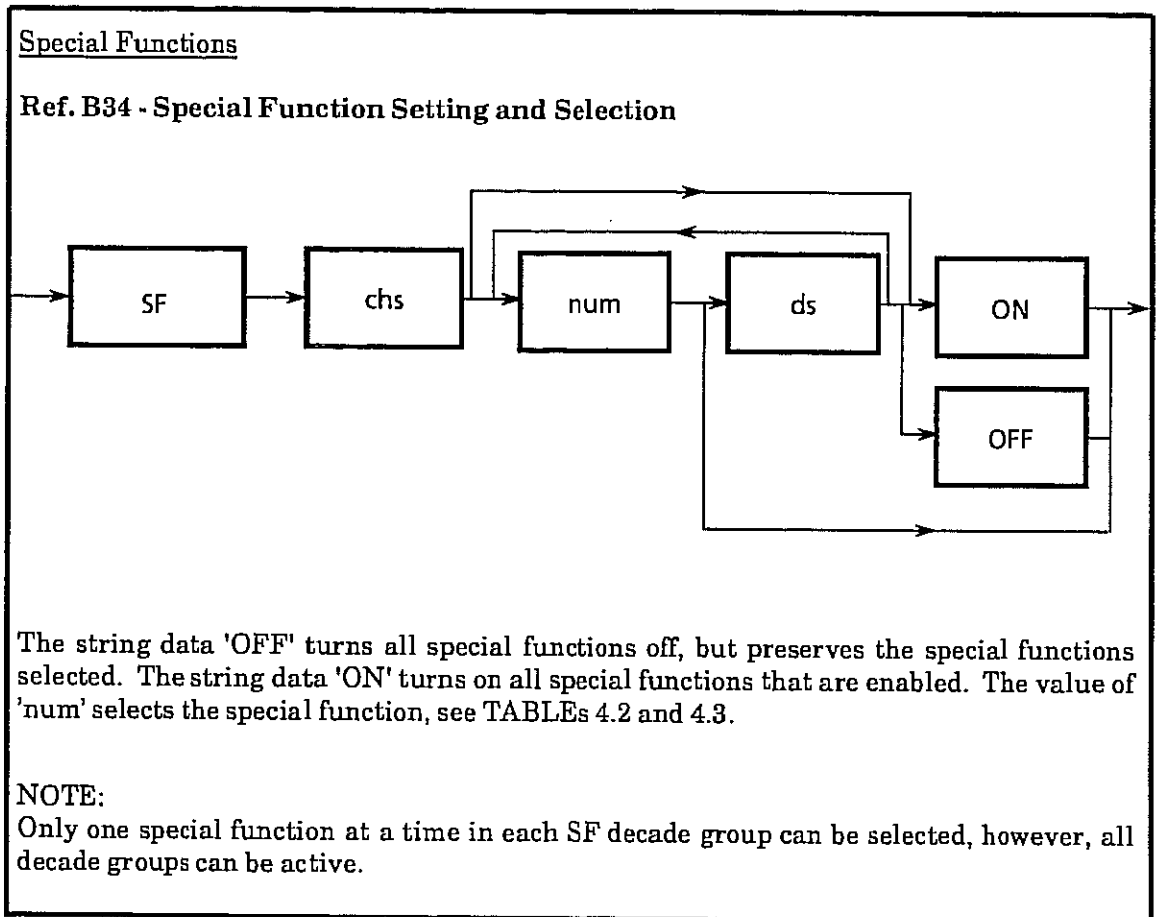

NOTE 1:

Ref. B20 - Dump Mode:

Dump Mode still requires a query command to output measurements. The query command 'MEAS?' is used for single measurements. 'MEAS:CONT?' is used for a continuous stream of results at maximum speed. See also Ref. B12.

TABLE 4.15

Permitted Terminators

1	2	3
LF	LF END true	Last Character END true

NOTE: LF = Line Feed
 END = 'Last Byte', identifies in Word Serial
 'Byte Available' command.

TABLE 4.16

Numerical Input Format

Byte No.	Interpretation	Permitted ASCII Characters
1	Sign of Mantissa	+ or -
2	Most Significant Digit	0 to 9 or .
3	Digit	0 to 9 or .
4	Digit	0 to 9 or .
5	Digit	0 to 9 or .
6	Digit	0 to 9 or .
7	Digit	0 to 9 or .
8	Digit	0 to 9 or .
9	Digit	0 to 9 or .
10	Digit	0 to 9 or .
11	Digit	0 to 9 or .
12	Digit	0 to 9 or .
13	Least Significant Digit	0 to 9 or .
14	Character has no meaning	White Space
15	Exponent Indicator	E
16	Character has no meaning	White Space
17	Sign of Exponent	+ or -
18	More Significant Digit	0 to 9
19	Digit	0 to 9
20	Digit	0 to 9
21	Digit	0 to 9
22	Least Significant Digit	0 to 9

NOTE 1:
 At least one exponent digit must be used if 'E' (byte 15) is present.

NOTE 2:
 The numerical input format conforms to IEEE 488.2 and is based on NR1, NR2 and NR3 formats. Any number input that deviates from these formats will generate a command error. If the number is out of range for a particular command header, then an execution error is reported. For some commands the resolution of the mantissa is limited.

TABLE 4.17

Special Function Request (SF?) Response Format

SF Groups >	10	20	30	40	50	60	70	80	90	ON/OFF	
Response Format >	n	,	n	,	n	,	n	,	n	,	n

'n' is a single digit representing the function selected in a particular group.

TABLE 4.18

Alphabetic List of Required Command Codes

Code	Function	Code	Function
*CLS	Clear status	*OPC?	Operation Complete Query
*ESE	Standard Event Status Event	*RST	Reset
*ESE?	Standard Event Status Event Query	*SRE	Service Request Enable
*ESR?	Standard Event Status Query	*SRE?	Service Request Enable Query
*IDN?	Identification Query	*STB	Status Byte Query
*OPC	Operation Complete	*TST?	Self Test Query
		*WAI	Wait to continue

TABLE 4.19

Alphabetic List of Optional Command Codes

	Code	Function	Code	Function	
o	ATTENA	Selects INPUT A attenuator	LO?	Local oscillator store	*o
s	ATTENA?	INPUT A Attenuator query		query	
o	CHECK	Selects 10 MHz check	LOWFM	Controls Low FM	*o
o	CLK10	Selects CLK10 standard	MAN	Controls manual select	*o
s	DISP?	Displays value in output queue	MAN?	Manual store query	*o
o	DUMP	Controls DUMP mode	MEAS?	New reading cycle	o
s	ESE	Device Event Status Enable	MEAS:	Continuous stream of readings	o
s	ESE?	Device Event Status Register query	CONT?	Controls Multiplier	o
s	ESR?	Device Event Register Query	MULT	MULT store query	s
o	FILTA	Selects INPUT A filter	MULT?	Controls Offset	o
s	FILTA?	INPUT A Pass Filter query	OFFSET	Offset store query	s
o	FRQA	Selects INPUT A	OFFSET?	Selects RATIO A/B	o
o	FRQB	Selects INPUT B	RACA	Selects RATIO C/A	*o
o*	FRQC	Selects INPUT C	RACB	Selects RATIO C/B	*o
s	GATE?	Gating status query	SAMPLE	Controls measurement sample rate	s
s*	HN	Harmonic number setting	SAMPLE?	Sample store query	s
s*	HN?	Harmonic number store query	SF	Controls Special Functions	o
o	HOLD	Selects HOLD mode	SF?	Special Functions query	s
s*	LO	Local oscillator setting	STD?	Standard in-use query	s
			TRACK	Controls Track Trigger command	*o

NOTE:

- o denotes an overlapped command.
- s denotes a sequential command.
- * denotes command applies only to 2151.



Artisan Technology Group is your source for quality new and certified-used/pre-owned equipment

- FAST SHIPPING AND DELIVERY
- TENS OF THOUSANDS OF IN-STOCK ITEMS
- EQUIPMENT DEMOS
- HUNDREDS OF MANUFACTURERS SUPPORTED
- LEASING/MONTHLY RENTALS
- ITAR CERTIFIED SECURE ASSET SOLUTIONS

SERVICE CENTER REPAIRS

Experienced engineers and technicians on staff at our full-service, in-house repair center

*InstraView*SM REMOTE INSPECTION

Remotely inspect equipment before purchasing with our interactive website at www.instraview.com ↗

WE BUY USED EQUIPMENT

Sell your excess, underutilized, and idle used equipment. We also offer credit for buy-backs and trade-ins. www.artisanng.com/WeBuyEquipment ↗

LOOKING FOR MORE INFORMATION?

Visit us on the web at www.artisanng.com ↗ for more information on price quotations, drivers, technical specifications, manuals, and documentation

Contact us: (888) 88-SOURCE | sales@artisanng.com | www.artisanng.com