



Artisan Technology Group is your source for quality new and certified-used/pre-owned equipment

- FAST SHIPPING AND DELIVERY
- TENS OF THOUSANDS OF IN-STOCK ITEMS
- EQUIPMENT DEMOS
- HUNDREDS OF MANUFACTURERS SUPPORTED
- LEASING/MONTHLY RENTALS
- ITAR CERTIFIED SECURE ASSET SOLUTIONS

SERVICE CENTER REPAIRS

Experienced engineers and technicians on staff at our full-service, in-house repair center

*InstraView*SM REMOTE INSPECTION

Remotely inspect equipment before purchasing with our interactive website at www.instraview.com ↗

WE BUY USED EQUIPMENT

Sell your excess, underutilized, and idle used equipment. We also offer credit for buy-backs and trade-ins. www.artisanng.com/WeBuyEquipment ↗

LOOKING FOR MORE INFORMATION?

Visit us on the web at www.artisanng.com ↗ for more information on price quotations, drivers, technical specifications, manuals, and documentation

Contact us: (888) 88-SOURCE | sales@artisanng.com | www.artisanng.com

Rasmi Electronics Footprint and Book type RFI Filters for Omron Inverters and Servo Drives

October 1st 2001

RFI Filters for

● 3G3EV Series	Page 3
● 3G3JV Series	Page 4
● 3G3MV Series	Page 5
● 3G3FV Series	Page 6
● 3G3RV and 3G3PV 200V Series	Page 7
● 3G3RV and 3G3PV 400V Series	Page 8
● R88D U and W Series	Page 9
● PFO Cable Chokes	Page 10
● Installation Recommendations	Page 11-12

ALL PRICES ARE EX-WORKS RASMI ELECTRONICS, UK.

ALL ABOVE GOODS ARE EX-STOCK

DESPATCH MAXIMUM SEVEN DAYS FROM RECEIPT OF ORDER.

●Requirements

Recent European legislation on EMC imposes limits on RF emissions from electrical equipment. The PFI and FIU ranges of power line filters have been specifically developed for use with Omron motor drives, enabling systems incorporating them to meet the European RFI emissions standards for domestic or industrial use.

For drives up to 15kW, the filters are of a footprint design. These are installed between the drive and the panel, keeping the panel area required to a minimum. For larger drives the filter is mounted separately, alongside.

●European Standards

The European Standard for EMC of Adjustable Speed Electrical Power Drive Systems, **EN 61800-3**, requires all drives using below 25A per phase to meet domestic emissions limits (EN55011 Class B). Systems using more than 25A per phase should meet industrial emission limits (EN55011 Class A).

●Ranges Covered

Inverters	200V single phase	200V three phase	400V three phase filter
3G3EV	0.1 to 1.5kW - footprint		0.7 to 1.5kW - footprint
3G3JV	0.1 to 1.5kW - footprint	0.1 to 4.0kW - footprint	0.2 to 4.0kW - footprint
3G3MV	0.1 to 4.0kW - footprint	0.1 to 7.5kW - footprint	0.2 to 7.5kW - footprint
3G3FV			0.4 to 15kW - footprint 18.5 to 300kW - standard
3G3RV		0.4 to 18.5kW - footprint 22 to 45kW - book	0.4 to 18.5kW - footprint 22 to 90kW - book

AC Servo Drives	200V single phase	200V three phase	400V three phase filter
R88D U	30 to 750W - footprint	1.0 to 5.0kW - footprint	
R88D W	30 to 1500W - footprint		0.5 to 3.0kW - footprint

●Construction

All filters carry the **CE** mark in accordance with the Low Voltage Directive.

Self-healing X and Y capacitors approved to VDE, SEMKO, UL.

Components encapsulated with UL 94-V0 flammability class resin in larger filters.

Input and output connections by shrouded terminals (up to 15kW), stud bolts or bus bars.

Earthing by stud bolt or bus bar directly to the casing.

●Earth Leakage

Nuisance tripping of earth leakage breakers is a common problem associated with EMC filters. The circuits used in the Omron drive filter ranges feature very low leakage currents to avoid this problem.

Typical earth leakages are:-

Single phase filter	3.5mA
3 phase filter up to 15kW	28mA
3 phase filter 15 → 300kW	50 → 200mA

These are "worst case" currents, that may occur when a supply phase is disconnected or momentarily during switch-on. The nominal earth leakage current during normal operation is less than 1mA.

●Operating Conditions

Ambient operating temperature range of -10°C to +40°C.

Temperature rise of no more than 50°C at the rated current.

150% overload permissible for up to 60 seconds.

●PFO Chokes

The PFO output chokes can be used in conjunction with the filters to improve EMC performance. They are especially effective where radiated emissions from long drive to motor cables are a problem.

●Use of Filters with 200V Three Phase Inverters

These filter ranges may also be used with 200V three phase inverters, but care should be taken in the filter selection. The equivalent 200V model of an inverter will require approximately twice the current of the 400V model. For example, the 3G3FV PFI 4012E filter is suitable for the 3G3FV A2015 drive but not the 3G3FV A2037, even though the latter will fit. Running a filter on under-voltage is perfectly acceptable, but running at over-current for any extended period is not advisable.

●Technical Information

For more technical data, a separate data sheet is available for each filter model. This gives detailed dimensions, circuit diagram and electrical ratings.

(2)

●Filters for 3G3EV Series Inverters

Footprint Type Design- Preleaded
for motor cables up to 100m

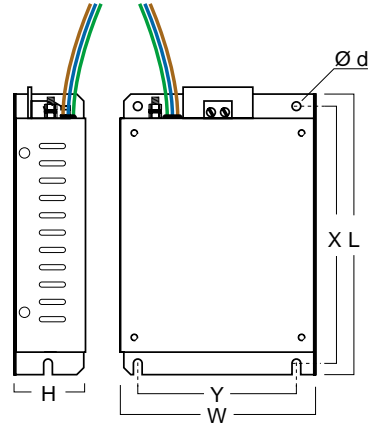

Drive	Filter	Current (A)	L (mm)	W (mm)	H (mm)	X (mm)	Y (mm)	d	price (euro)
3G3EV AB001 3G3EV AB002	3G3EV PFI 1010E (N)	10A	165	70	41	150	51	M5	12.00
3G3EV AB004 3G3EV AB007	3G3EV PFI 1015E (N)	10A	165	112	41	150	91	M5	13.71
3G3EV AB015	3G3EV PFI 1020E	20A	165	134	42	150	91	M5	16.00
3G3EV A4007 3G3EV A4015	3G3EV PFI 3006E 3G3EV PFI 3008E	6A 8A	165	112 134	41 42	150	91	M5	23.00 27.00

Footprint Type Design

for motor cables up to 10m

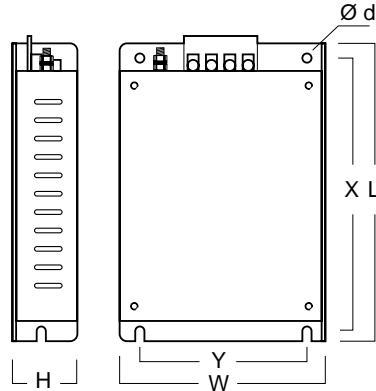

Drive	Filter	Current (A)	L (mm)	W (mm)	H (mm)	X (mm)	Y (mm)	d	price (euro)
3G3EV AB001 3G3EV AB002	3G3EV PFI 1010E	10	165	70	35	150	51	M5	12.00
3G3EV AB004 3G3EV AB007	3G3EV PFI 1015E	15	165	112	35	150	91	M5	13.71

●Filters for 3G3JV Series Inverters

Footprint Type Design- Preleaded

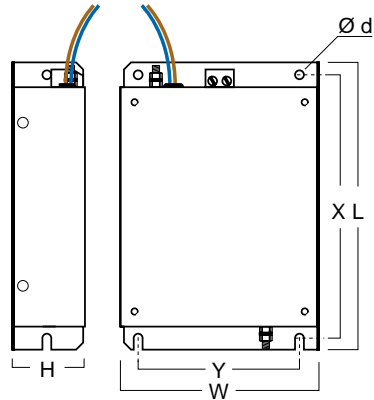

Drive	Filter	Rated Current	Earth Leakage*	L	W	H	X	Y	d	price (euro)
				(mm)			(mm)			
3G3JV AB001 3G3JV AB002 3G3JV AB004	3G3JV PFI 1010E	10A	7.0mA	169	71	45	156	51	M5	12.00
3G3JV AB007 3G3JV AB015	3G3JV PFI 1020E	20A	7.0mA	169	111	50	156	91	M5	15.00
3G3JV A2001 3G3JV A2002 3G3JV A2004 3G3JV A2007	3G3JV PFI 2010E	10A	0.3/26mA	194	82	50	181	62	M5	27.00
3G3JV A2015 3G3JV A2022	3G3JV PFI 2020E	16A	0.3/16mA	169	111	50	156	91	M5	33.00
3G3JV A2040	3G3JV PFI 2030E	26A	0.4/30mA	174	144	50	161	120	M5	33.00
3G3JV A4002 3G3JV A4004	3G3JV PFI 3005E	5A	0.5/29mA	169	111	50	156	91	M5	23.00
3G3JV A4007 3G3JV A4015 3G3JV A4022	3G3JV PFI 3010E	10A	0.5/29mA	169	111	50	156	91	M5	27.00
3G3JV A4030 3G3JV A4040	3G3JV PFI 3020E	15A	0.5/29mA	174	144	50	161	120	M5	33.00

* Earth leakage for three-phase is nominal / maximum (three phases / one phase connected).

●Filters for 3G3MV Series Inverters

Footprint Type Design- Preleaded

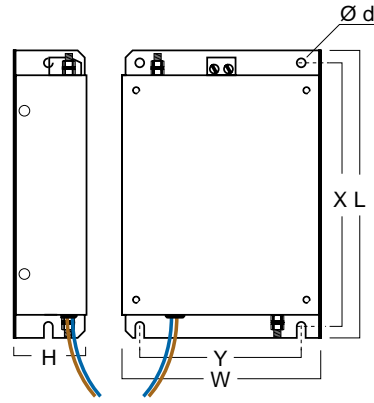

Drive	Filter	Rated Current	Earth Leakage*	L	W	H	X	Y	d	price (euro)
				(mm)			(mm)			
3G3MV AB001 3G3MV AB002 3G3MV AB004	3G3MV PFI 1010E	10A	7.0mA	169	71	45	156	51	M5	12.00
3G3MV AB007 3G3MV AB015	3G3MV PFI 1020E	20A	7.0mA	169	111	50	156	91	M5	15.00
3G3MV AB022	3G3MV PFI 1030E	30A	3.5mA	174	144	50	161	120	M5	23.00
3G3MV AB040	3G3MV PFI 1040E	40A	3.5mA	174	174	50	161	150	M5	27.00
3G3MV A2001 3G3MV A2002 3G3MV A2004 3G3MV A2007	3G3MV PFI 2010E	10A	0.3/26mA	194	82	50	181	62	M5	27.00
3G3MV A2015 3G3MV A2022	3G3MV PFI 2020E	16A	0.3/16mA	169	111	50	156	91	M5	33.00
3G3MV A2040	3G3MV PFI 2030E	26A	0.3/17mA	174	144	50	161	120	M5	33.00
3G3MV A2055 3G3MV A2075	3G3MV PFI 2050E	50A	0.6/57mA	304	184	56	288	150	M6	43.00
3G3MV A4002 3G3MV A4004 3G3MV A4007	3G3MV PFI 3005E	5A	0.5/29mA	169	111	45	156	91	M5	23.00
3G3MV A4015 3G3MV A4022	3G3MV PFI 3010E	10A	0.5/29mA	169	111	45	156	91	M5	27.00
3G3MV A4030 3G3MV A4040	3G3MV PFI 3020E	15A	0.5/29mA	174	144	50	161	120	M5	33.00
3G3MV A4055 3G3MV A4075	3G3MV PFI 3030E	30A	0.7/60mA	304	184	56	288	150	M6	43.00

* Earth leakage for three-phase is nominal / maximum (three phases / one phase connected).

●Filters for 3G3FV Series Inverters

Footprint Type Design up to 15kW
for motor cables up to 100m

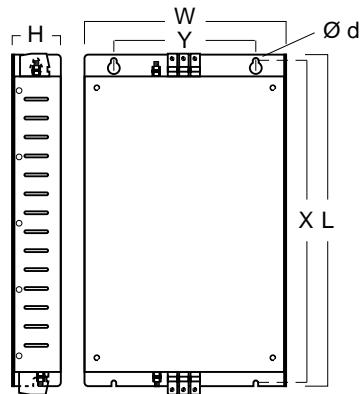

Drive	Filter	Current (A)	L (mm)	W (mm)	H (mm)	X (mm)	Y (mm)	d	price (euro)
3G3FV A4004 3G3FV A4007 3G3FV A4015 3G3FV A4022 3G3FV A4037	3G3FV PFI 4012E	12	320	143	46	310	90	M5	36.00
3G3FV A4055 3G3FV A4075	3G3FV PFI 4025E	25	350	213	51	330	150	M6	44.00
3G3FV A4110 3G3FV A4150	3G3FV PFI 4040E	40	435	268	56	415	200	M6	60.00

Standard Type Design over 15kW
for motor cables up to 100m

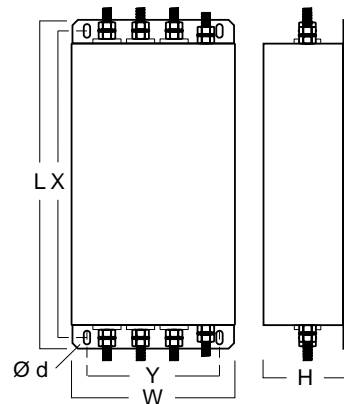

Drive	Filter	Current (A)	L (mm)	W (mm)	H (mm)	X (mm)	Y (mm)	d	price (euro)
3G3FV B4185 3G3FV B4220 3G3FV B4300	3G3FV PFI 4060E	60	270	140	90	258	106	M6	91.00
3G3FV B4370	3G3FV PFI 4100E	100	350	180	90	338	146	M6	150.00
3G3FV B4450	3G3FV PFI 4120E	120	435	200	130	408	166	M6	178.00
3G3FV B4550	3G3FV PFI 4150E	150	435	200	130	408	166	M6	200.00
3G3FV B4750-E	3G3FV PFI 4180E	180	495	200	160	468	166	M6	285.00
3G3FV B411K-E	3G3FV PFI 4280E	280	495	200	160	468	166	M6	454.00
3G3FV B416K-E 3G3FV B418K-E	3G3FV PFI 4450E	450	587	250	205	560	170	M6	650.00
3G3FV B422K-E	3G3FV PFI 4600E	600	688	364	180	648	300	M6	750.00
3G3FV B430K-E	3G3FV PFI 4900E	900	688	364	180	648	300	M6	1200

●Filters for 3G3RV and 3G3PV 200V Series Inverters

Footprint Type Design up to 18.5kW

Designed to meet EN55011 Class B (domestic environment) with up to 25m motor cable and EN55011 Class A (industrial environment) with up to 100m motor cable.

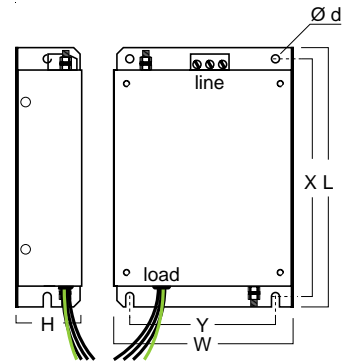

Drive	Filter	Current (A)	L (mm)	W (mm)	H (mm)	X (mm)	Y (mm)	d (mm)	price (euro)
3G3RV(PV) A2004-E 3G3RV(PV) A2007-E 3G3RV(PV) A2015-E	3G3RV PFI 3010E	10	330	143	46	313	115	M5	36.00
3G3RV(PV) A2022-E 3G3RV(PV) A2037-E 3G3RV(PV) A2055-E	3G3RV PFI 3018E 3G3RV PFI 2035E	18 35	330	143	46	313	115	M5	40.00 60.00
3G3RV(PV) A2075-E 3G3RV(PV) A2110-E	3G3RV PFI 2060E	60	355	213	60	336	175	M6	94.00
3G3RV(PV) A2150-E 3G3RV(PV) A2185-E	3G3RV PFI 2100E	100	408	238	80	390	205	M6	146.00

Book Type Design over 18.5kW

Designed to meet EN55011 Class A (industrial environment) with up to 100m motor cable.

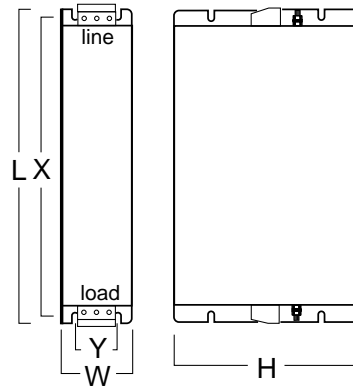
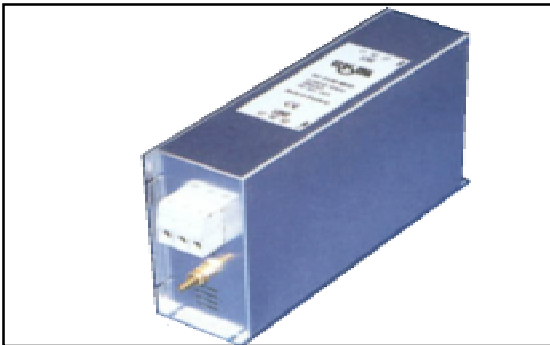

Drive	Filter	Current (A)	L (mm)	W (mm)	H (mm)	X (mm)	Y (mm)	d (mm)	price (euro)
3G3RV(PV) B2220-E 3G3RV(PV) B2300-E	3G3RV PFI 2130E	130	310	90	180	295	65	M6	188.00
3G3RV(PV) B2370-E 3G3RV(PV) B2450-E	3G3RV PFI 2160E 3G3RV PFI 2200E	160 200	380 518	120 130	170 240	365 498	102 90	M6 M8	266.00 446.00
3G3RV(PV) B2550-E 3G3RV(PV) B2750-E 3G3RV(PV) B2900-E 3G3RV(PV) B211K-E	under development								

●Filters for 3G3RV and 3G3PV Series Inverters

Footprint Type Design up to 18.5kW

Designed to meet EN55011 Class B (domestic environment) with up to 25m motor cable and EN55011 Class A (industrial environment) with up to 100m motor cable.

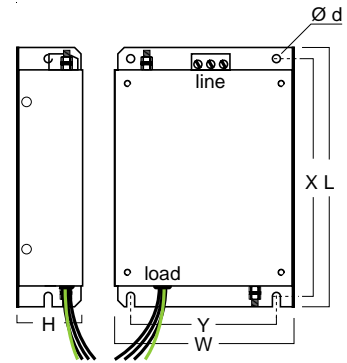

Drive	Filter	Current (A)	L (mm)	W (mm)	H (mm)	X (mm)	Y (mm)	d (mm)	price (euro)
3G3RV(PV) A4004-E 3G3RV(PV) A4007-E 3G3RV(PV) A4015-E 3G3RV(PV) A4022-E	3G3RV PFI 3010E	10	330	143	46	313	115	M5	36.00
3G3RV(PV) A4037-E 3G3RV(PV) A4055-E	3G3RV PFI 3018E	18	330	143	46	313	115	M5	40.00
3G3RV(PV) A4075-E 3G3RV(PV) A4110-E	3G3RV PFI 3035E	35	355	213	51	336	175	M6	60.00
3G3RV(PV) A4150-E 3G3RV(PV) A4185-E	3G3RV PFI 3060E	60	408	238	60	390	205	M6	91.00

Book Type Design over 18.5kW

Designed to meet EN55011 Class A (industrial environment) with up to 100m motor cable.

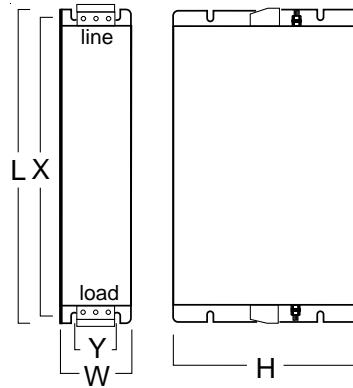
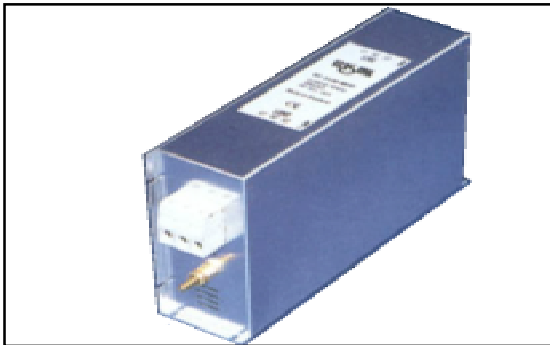

Drive	Filter	Current (A)	L (mm)	W (mm)	H (mm)	X (mm)	Y (mm)	d (mm)	price (euro)
3G3RV(PV) B4220-E 3G3RV(PV) B4300-E	3G3RV PFI 3070E	70	329	80	220	314	55	M6	101.00
3G3RV(PV) B4370-E 3G3RV(PV) B4450-E	3G3RV PFI 3100E	100	310	90	180	295	65	M6	150.00
3G3RV(PV) B4550-E	3G3RV PFI 3130E	130	310	90	180	295	65	M6	178.00
3G3RV(PV) B4750-E	3G3RV PFI 3170E	170	380	120	170	365	102	M6	285.00
3G3RV(PV) B4900-E	3G3RV PFI 3200E	200	518	130	240	498	90	M8	454.00
3G3RV(PV) B411K-E 3G3RV(PV) B413K-E 3G3RV(PV) B416K-E 3G3RV(PV) B418K-E 3G3RV(PV) B422K-E 3G3RV(PV) B430K-E	under development								

●Filters for R88D U Series Servo Drives

Footprint Type Design

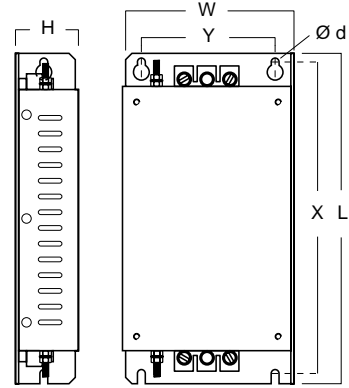

Drive	Filter	Current (A)	L	W (mm)	H	X	Y	d	price (euro)
R88D UA02H R88D UA03H R88D UA04H R88D UA08H	R88A FIU 105E	5	215	67	38	205	48	M5	11.65
R88D UA12H	R88A FIU 110E	10	210	80	40	197	57	M5	14.53
R88D UA20H	R88A FIU 115E	15	210	110	40	200	85	M5	16.45
R88D UT40H	R88A FIU 4020E	20	300	111	46	287	80	M5	40.00
R88D UT60H R88D UT80H	R88A FIU 4040E	40	300	152	47	283	120	M6	60.00
R88D UT110H R88D UT120H	R88A FIU 4060E	60	300	210	56	283	140	M6	91.00

●Filters for R88D W Series Servo Drives

Footprint Type Design

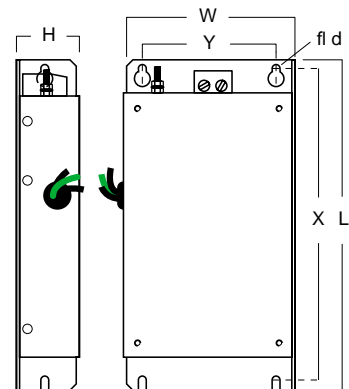

Drive	Filter	Current (A)	L	W (mm)	H	X	Y	d	price (euro)
up to R88D WT02H	R88A FIW 104E	4	202	55	32	192	33	M4	21.68
R88D WA04H	R88A FIW 107E	7	202	75	32	192	50	M4	28.35
R88D WA08HH	R88A FIW 115E	15	202	90	32	192	60	M4	43.36
R88D WA15HH	R88A FIW 125E	25	291	118	35	281	80	M4	53.36
R88D WT05HF to R88D WT15HF	R88A FIW 4006E	6	291	118	32	192	80	M4	33.35
R88D WT20HF R88D WT30HF	R88A FIW 4010E	10	291	118	35	281	80	M4	45.02

●PFO Motor Cable Chokes

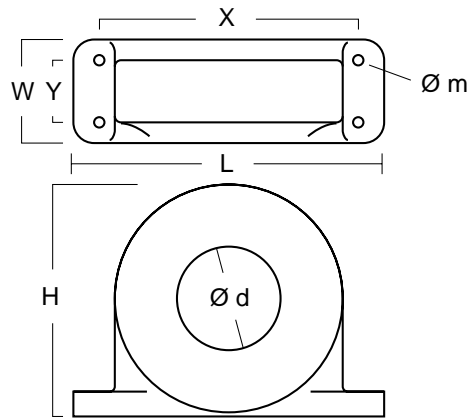
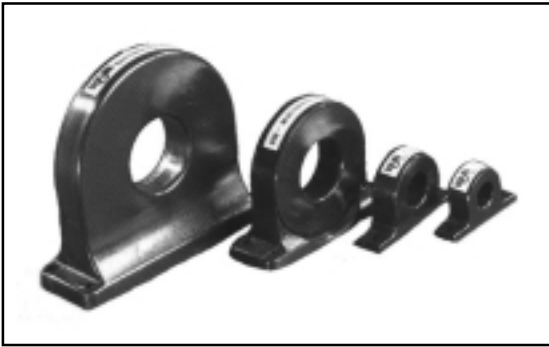

Output Choke	motor kW	D (mm)	L	W (mm)	H	X	Y (mm)	m	price (euro)
3G3IV PFO OC/1	≤ 2.2	21	85	22	46	70	-	5	5.24
3G3IV PFO OC/2	≤ 15	28	105	25	62	90	-	5	7.43
3G3IV PFO OC/3	≤ 45	50	150	50	110	125	30	5	11.65
3G3IV PFO OC/4	> 45	60	200	65	170	180	45	6	20.29

The PFO output chokes can be used in conjunction with the filters to improve EMC performance. They are especially effective where radiated emissions from long drive to motor cables are a problem e.g. corruption of near by control or data cable signals or radio / television interference. The correct fitting of a PFO choke into the motor cable can eliminate these problems.

The table above gives approximate motor kW ratings for the chokes but the selection is ultimately governed by the type and thickness of motor cable fitted i.e. the motor cable must fit through the PFO choke centre hole.

Occasionally EMC problems will occur within an installation when components in the same wiring enclosure affect one another, for example, open control boards may corrupt low level sensor signals. Usually in these cases the fitting of additional chokes into the control and sensor cables will cure the problem - a small amount of experimentation may be required to determine the optimum configuration of these additional chokes.

●Footprint Type EMC Filter Installation Recommendations

TO CONFORM TO THE EMC DIRECTIVE, IT IS NECESSARY THAT THESE INSTRUCTIONS BE FOLLOWED AS CLOSELY AS POSSIBLE. FOLLOW THE USUAL SAFETY PROCEDURES WHEN WORKING WITH ELECTRICAL EQUIPMENT. ALL ELECTRICAL CONNECTIONS TO THE FILTER, INVERTER & MOTOR MUST BE MADE BY A QUALIFIED ELECTRICAL TECHNICIAN.

- 1) Check the filter rating label to ensure that the current, voltage rating and part number are correct.
- 2) For best results the filter should be fitted as closely as possible to the incoming mains supply of the wiring enclosure, usually directly after the enclosures circuit breaker or supply switch.
- 3) The back panel of the wiring cabinet of board should be prepared for the mounting dimensions of the filter. Care should be taken to remove any paint etc. from the mounting holes and face area of the panel to ensure the best possible earthing of the filter.
- 4) Mount the filter securely. Mount the inverter on top of the filter using the mounting screws provided.
- 5) Connect the mains supply to the filter terminals marked "LINE", connect any earth cables to the earth stud provided. Connect the filter terminals marked "LOAD" to the mains input of the inverter using short lengths of appropriate gauge cable (Some filter models are pre-leaded).
- 6) Connect the motor and fit any PFO chokes required, as close to the inverter as possible. Armoured or screened cable should be used with **the 3 phase conductors only** threaded twice through the centre of the Ferrite Core. The earth conductor should be securely earthed at both inverter and motor ends. The screen should be connected to the enclosure body via an earthed cable gland.
- 7) Connect any control cables as instructed in the inverter instruction manual.

IT IS IMPORTANT THAT ALL LEAD LENGTHS ARE KEPT AS SHORT AS POSSIBLE AND THAT INCOMING MAINS AND OUTGOING MOTOR CABLES ARE KEPT WELL SEPARATED.

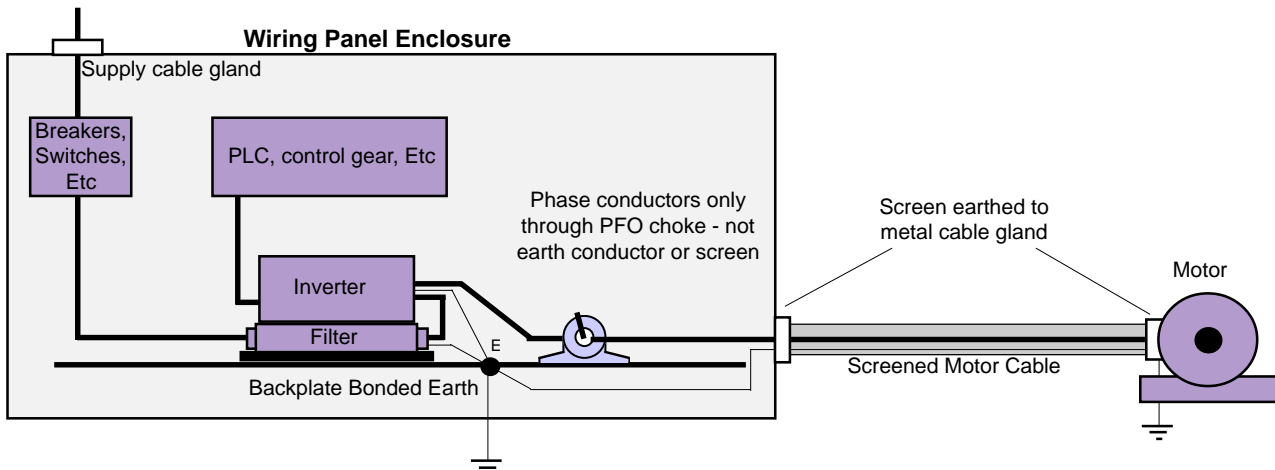

●Standard Type EMC Filter Installation Recommendations

TO CONFORM TO THE EMC DIRECTIVE, IT IS NECESSARY THAT THESE INSTRUCTIONS BE FOLLOWED AS CLOSELY AS POSSIBLE. FOLLOW THE USUAL SAFETY PROCEDURES WHEN WORKING WITH ELECTRICAL EQUIPMENT. ALL ELECTRICAL CONNECTIONS TO THE FILTER, INVERTER & MOTOR MUST BE MADE BY A QUALIFIED ELECTRICAL TECHNICIAN.

- 1) Check the filter rating label to ensure that the current, voltage rating and part number are correct.
- 2) For best results the filter should be fitted as closely as possible to the incoming mains supply of the wiring enclosure, usually directly after the enclosures circuit breaker or supply switch.
- 3) The back panel of the wiring cabinet or board should be prepared for the mounting dimensions of the filter. Care should be taken to remove any paint etc. from the mounting holes and face area of the panel to ensure the best possible earthing of the filter.
- 4) Mount the filter securely.
- 5) Connect the mains supply to the filter terminals marked "LINE", connect any earth cables to the earth stud provided. Connect the filter terminals marked "LOAD" to the mains input of the inverter using short lengths of appropriate gauge cable.
- 6) Connect the motor and fit any PFO chokes required, as close to the inverter as possible. Armoured or screened cable should be used with **the 3 phase conductors only** threaded twice through the centre of the Ferrite Core. The earth conductor should be securely earthed at both inverter and motor ends. The screen should be connected to the enclosure body via an earthed cable gland.
- 7) Connect any control cables as instructed in the inverter instruction manual.

IT IS IMPORTANT THAT ALL LEAD LENGTHS ARE KEPT AS SHORT AS POSSIBLE AND THAT INCOMING MAINS AND OUTGOING MOTOR CABLES ARE KEPT WELL SEPARATED.

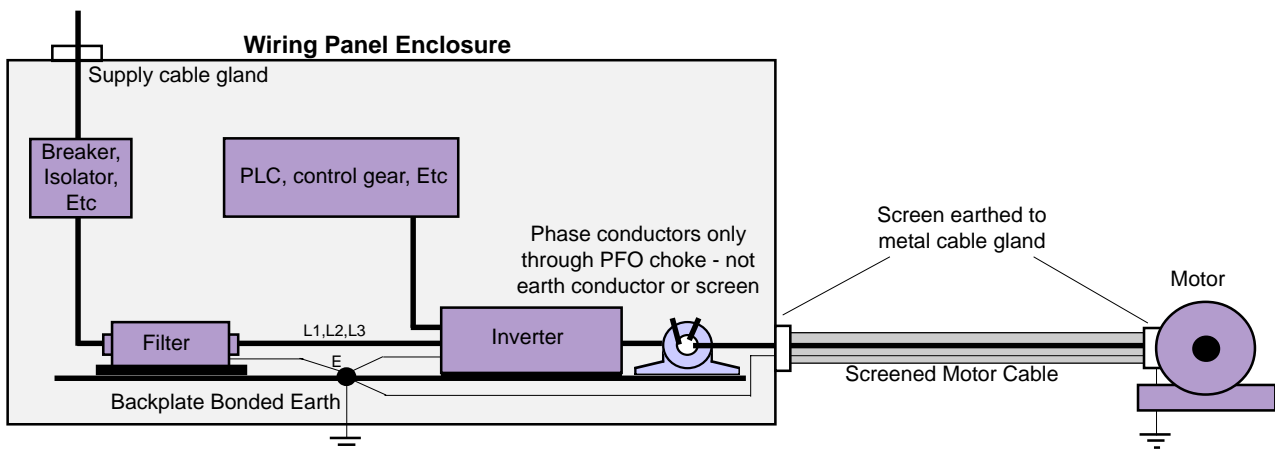

In the interest of product improvement, specifications are subject to change without notice.



Artisan Technology Group is your source for quality new and certified-used/pre-owned equipment

- FAST SHIPPING AND DELIVERY
- TENS OF THOUSANDS OF IN-STOCK ITEMS
- EQUIPMENT DEMOS
- HUNDREDS OF MANUFACTURERS SUPPORTED
- LEASING/MONTHLY RENTALS
- ITAR CERTIFIED SECURE ASSET SOLUTIONS

SERVICE CENTER REPAIRS

Experienced engineers and technicians on staff at our full-service, in-house repair center

*InstraView*SM REMOTE INSPECTION

Remotely inspect equipment before purchasing with our interactive website at www.instraview.com ↗

WE BUY USED EQUIPMENT

Sell your excess, underutilized, and idle used equipment. We also offer credit for buy-backs and trade-ins. www.artisanng.com/WeBuyEquipment ↗

LOOKING FOR MORE INFORMATION?

Visit us on the web at www.artisanng.com ↗ for more information on price quotations, drivers, technical specifications, manuals, and documentation

Contact us: (888) 88-SOURCE | sales@artisanng.com | www.artisanng.com