



Artisan Scientific

QUALITY INSTRUMENTATION ... GUARANTEED

Looking for more information?

Visit us on the web at <http://www.artisan-scientific.com> for more information:

- Price Quotations
- Drivers
- Technical Specifications, Manuals and Documentation

Artisan Scientific is Your Source for Quality New and Certified-Used/Pre-owned Equipment

- Tens of Thousands of In-Stock Items
- Hundreds of Manufacturers Supported
- Fast Shipping and Delivery
- Leasing / Monthly Rentals
- Equipment Demos
- Consignment

Service Center Repairs

Experienced Engineers and Technicians on staff in our State-of-the-art Full-Service In-House Service Center Facility

InstraView™ Remote Inspection

Remotely inspect equipment before purchasing with our Innovative InstraView™ website at <http://www.instraview.com>

We buy used equipment! We also offer credit for Buy-Backs and Trade-Ins

Sell your excess, underutilized, and idle used equipment. Contact one of our Customer Service Representatives today!

Talk to a live person: 888-88-SOURCE (888-887-6872) | Contact us by email: sales@artisan-scientific.com | Visit our website: <http://www.artisan-scientific.com>



Rasmi Electronics Ltd.
RFI and EMC Filters

Footprint and Block RFI filters for

YASKAWA

**V1000, J7, V7, G5, P5, F7, E7 motor inverters
and Sigma II servo drives**



Footprint and Block RFI filters for **YASKAWA** motor inverters and servo drives

Requirements

Recent European legislation on EMC imposes limits on RF emissions from electrical equipment. These power line filters have been specifically developed for use with Yaskawa motor drives, enabling systems incorporating them to meet the European RFI emissions standards for domestic or industrial use.

Ranges Covered

Inverters	200V Single Phase	200V Three Phase	400V Three Phase
J7	0.1 to 1.5kW - footprint type	0.1 to 4.0kW - footprint type	0.2 to 4.0kW - footprint type
V7	0.1 to 4.0kW - footprint type	0.1 to 7.5kW - footprint type	0.2 to 7.5kW - footprint type
V1000	0.1 to 4.0kW - footprint type	0.1 to 15kw - footprint type	0.2 to 15kW - footprint type
F7, E7		0.4 to 18.5kW - footprint type 22 to 110kW - block type	0.4 to 18.5kW - footprint type 22 to 300kW - block type
G5, P5			0.4 to 15.0kW - footprint type 18.5 to 300kW - block type

Servo Drives	200V Single Phase	200V Three Phase	400V Three Phase
Sigma II	0.03 to 1.5kW - footprint type		0.5 to 7.5kW - footprint type

Design and Test Criteria

Generally with motor drive systems, the emission levels are greatly affected by the length of the cable between the drive itself and the motor - longer cables will cause considerably higher emissions.

The inverter / filter combinations here have been designed and tested to achieve compliance to:-

EN 55022:1994, Class B for use in domestic / light industrial environments (Equivalent to the RF emissions tests of Power Drive Standard EN 61800-3:1996 for drives with <25A input current) when fitted with up to 25m motor output cable and to

EN 55011:1991 Group 1, Class A for use in industrial environments (Equivalent to the RF emissions tests of Power Drive Standard EN 61800-3:1996 for drives with >25A input current) when fitted with up to 50m motor output cable.

Earth Leakage Measurements

In single phase applications the earth leakage current is present all of the time.

For three phase applications under normal conditions with the three phases balanced, earth leakage currents are extremely small - the max values stated are worst possible values such as would occur momentarily during switch on or failure of one or two phases.

Use of Filters with 200V Three Phase Inverters

These filter ranges may also be used with 200V three phase inverters, but care should be taken in the filter selection. The equivalent 200V model of an inverter will require approximately twice the current of the 400V model. For example, the RS 3020-G5 filter is suitable for the CIMR-G5U1P5 drive, but not the CIMR-G5U2P2, even though the latter will fit. Running a filter on under-voltage is perfectly acceptable, but running at over-current for any extended period is not advisable.

Technical Information

For more technical data, a separate data sheet is available for each filter model. This gives detailed dimensions, circuit diagram and electrical ratings.

V1000

Dimensions

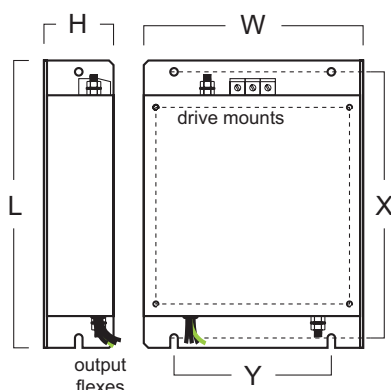

- The **V1K** range, especially for Yaskawa V1000 Series inverters.
- Help to ensure EMC compliance of machinery and installations using V1000 drives.
- Footprint filters mount between the inverter and the panel, saving valuable space inside wiring cabinets.
- All filters are designed and manufactured to UL requirements and are CE marked.

Applied Inverter	Filter Part No	Rated Current	Max Rated Voltage	Leakage current Nom / Max	External L x W x H (mm)	Mount Dims X x Y (mm)	Inverter Fixing
VZAB0P1 VZAB0P2 VZAB0P4	RF 1010-V1K	10A	1ph, 250V	7.0mA	169 x 71 x 45	156 x 51	M4
VZAB0P7 VZAB1P5	RF 1020-V1K	20A	1ph, 250V	7.0mA	169 x 111 x 50	156 x 91	M4
VZAB2P2	RF 1030-V1K	30A	1ph, 250V	3.5mA	174 x 144 x 50	161 x 120	M4
VZAB4P0	RF 1040-V1K	40A	1ph, 250V	3.5mA	174 x 174 x 50	161 x 150	M4
VZA20P1 VZA20P2 VZA20P4 VZA20P7	RF 2010-V1K	10A	3ph, 250V	0.3 / 26mA	194 x 82 x 50	181 x 62	M4
VZA21P5 VZA22P2	RF 2020-V1K	16A	3ph, 250V	0.3 / 16mA	169 x 111 x 50	156 x 91	M4
VZA24P0	RF2030-V1K	26A	3ph, 250V	0.3 / 17mA	174 x 144 x 50	161 x 120	M4
VZA25P5 VZA27P5	RF 2058-V1K	58A	3ph, 250V	0.3 / 27mA	320 x 150 x 52	290 x 122	M5
VZA2011	RF 2078-V1K	78A	3ph, 250V	0.3 / 27mA	362 x 188 x 62	330 x 160	M5
VZA2015	RF 2096-V1K	96A	3ph, 250V	0.3 / 27mA	415 x 220 x 62	380 x 192	M6
VZA40P2 VZA40P4 VZA40P7	RF 3005-V1K	5A	3ph, 480V	0.5 / 29mA	169 x 111 x 45	156 x 91	M4
VZA41P5 VZA42P2 VZA43P0	RF 3010-V1K	10A	3ph, 480V	0.5 / 29mA	169 x 111 x 45	156 x 91	M4
VZA44P0	RF 3020-V1K	15A	3ph, 480V	0.7 / 57mA	174 x 144 x 50	161 x 120	M4
VZA45P5 VZA47P5	RF 3029-V1K	29A	3ph, 480V	0.5 / 32mA	306 x 150 x 52	290 x 122	M5
VZA4011 VZA4015	RF 3048-V1K	48A	3ph, 480V	0.5 / 32mA	357 x 182 x 62	330 x 160	M5

Typical Circuit Schematics

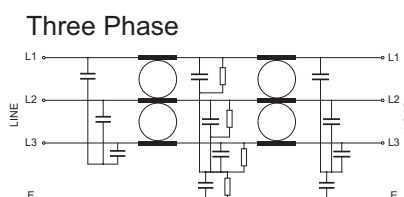
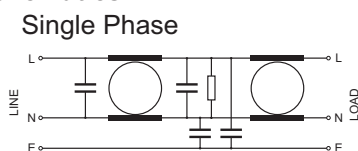

V1000(LL)

Dimensions

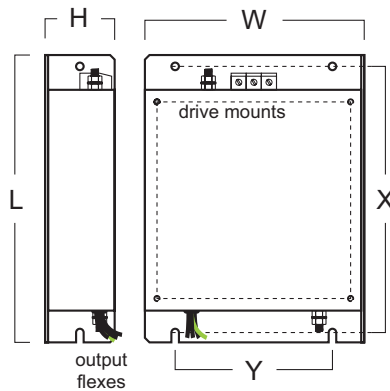

- The **V1K(LL)** range, especially for Yaskawa V1000 Series inverters.
- Low leakage current version.
- Help to ensure EMC compliance of machinery and installations using V1000 drives on short motor cables, if low leakage current is required.
- Footprint filters mount between the inverter and the panel, saving valuable space inside wiring cabinets.
- All filters are designed and manufactured to UL requirements and are CE marked.

Applied Inverter	Filter Part No	Rated Current	Max Rated Voltage	Leakage current Nom / Max	External L x W x H (mm)	Mount Dims X x Y (mm)	Inverter Fixing
VZAB0P1 VZAB0P2 VZAB0P4	RF 1010-V1K(LL)	10A	1ph, 250V	3.5mA	169 x 71 x 45	156 x 51	M4
VZAB0P7 VZAB1P5	RF 1020-V1K(LL)	20A	1ph, 250V	3.5mA	169 x 111 x 50	156 x 91	M4
VZAB2P2	RF 1030-V1K(LL)	30A	1ph, 250V	1.8mA	174 x 144 x 50	161 x 120	M4
VZAB4P0	RF 1040-V1K(LL)	40A	1ph, 250V	1.8mA	174 x 174 x 50	161 x 150	M4
VZA20P1 VZA20P2 VZA20P4 VZA20P7	RF 2010-V1K(LL)	10A	3ph, 250V	0.1 / 13mA	194 x 82 x 50	181 x 62	M4
VZA21P5 VZA22P2	RF 2020-V1K(LL)	16A	3ph, 250V	0.1 / 8mA	169 x 111 x 50	156 x 91	M4
VZA24P0	RF2030-V1K(LL)	26A	3ph, 250V	0.1 / 8mA	174 x 144 x 50	161 x 120	M4
VZA25P5 VZA27P5	RF 2058-V1K(LL)	58A	3ph, 250V	0.2 / 13mA	320 x 150 x 52	290 x 122	M5
VZA2011	RF 2078-V1K(LL)	78A	3ph, 250V	0.2 / 13mA	362 x 188 x 62	330 x 160	M5
VZA2015	RF 2096-V1K(LL)	96A	3ph, 250V	0.2 / 13mA	415 x 220 x 62	380 x 192	M6
VZA40P2 VZA40P4 VZA40P7	RF 3005-V1K(LL)	5A	3ph, 480V	0.3 / 15mA	169 x 111 x 45	156 x 91	M4
VZA41P5 VZA42P2 VZA43P0	RF 3010-V1K(LL)	10A	3ph, 480V	0.3 / 15mA	169 x 111 x 45	156 x 91	M4
VZA44P0	RF 3020-V1K(LL)	15A	3ph, 480V	0.4 / 29mA	174 x 144 x 50	161 x 120	M4
VZA45P5 VZA47P5	RF 3029-V1K(LL)	29A	3ph, 480V	0.3 / 16mA	306 x 150 x 52	290 x 122	M5
VZA4011 VZA4015	RF 3048-V1K(LL)	48A	3ph, 480V	0.3 / 16mA	357 x 182 x 62	330 x 160	M5

Typical Circuit Schematics

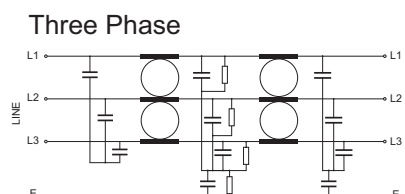
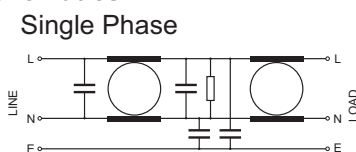

J7



- The **RS-J7** range, especially for Yaskawa J7 Series inverters.
- Help to ensure EMC compliance of machinery and installations using J7 drives.
- Footprint filters mount between the inverter and the panel, saving valuable space inside wiring cabinets.
- All filters are designed and manufactured to UL requirements and are CE marked.

Dimensions

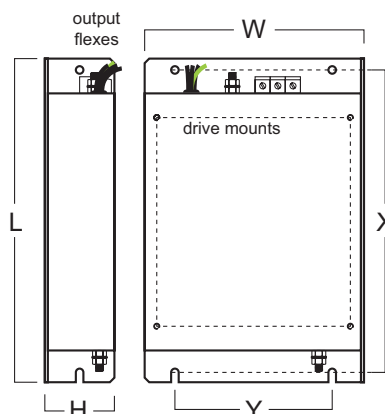

Applied Inverter	Filter Part No	Rated Current	Max Rated Voltage	Leakage current Nom / Max	External L x W x H (mm)	Mount Dims X x Y (mm)	Inverter Fixing	EMC Tested	UL
CIMR-J7AAB0P1 CIMR-J7AAB0P2 CIMR-J7AAB0P4	RS 1010-J7	10A	1ph, 250V	7.0mA	169 x 71 x 45	156 x 51	M4	✓	✓
CIMR-J7AAB0P7 CIMR-J7AAB1P5	RS 1020-J7	20A	1ph, 250V	7.0mA	169 x 111 x 50	156 x 91	M4	✓	✓
CIMR-J7AA20P1 CIMR-J7AA20P2 CIMR-J7AA20P4 CIMR-J7AA20P7	RS 2010-J7	10A	3ph, 250V	0.3 / 16mA	194 x 82 x 50	181 x 62	M4	✓	✓
CIMR-J7AA21P5 CIMR-J7AA22P2	RS 2020-J7	16A	3ph, 250V	0.3 / 16mA	169 x 111 x 50	156 x 91	M4	✓	✓
CIMR-J7AA23P7	RS 2030-J7	26A	3ph, 250V	0.4 / 30mA	174 x 144 x 50	161 x 120	M4	✓	✓
CIMR-J7AA40P2 CIMR-J7AA40P4	RS 3005-J7	5A	3ph, 440V	0.5 / 29mA	169 x 111 x 50	156 x 91	M4	✓	✓
CIMR-J7AA40P7 CIMR-J7AA41P5 CIMR-J7AA42P2	RS 3010-J7	10A	3ph, 440V	0.5 / 29mA	169 x 111 x 50	156 x 91	M4	✓	✓
CIMR-J7AA43P0 CIMR-J7AA43P7	RS 3020-J7	15A	3ph, 440V	0.5 / 29mA	174 x 144 x 50	161 x 120	M4	✓	✓

Typical Circuit Schematics

Single Phase

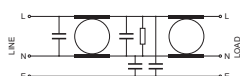

Three Phase

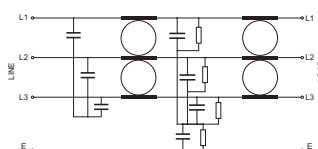

J7(LL)



- The **RS-J7(LL)** range, especially for Yaskawa J7 Series inverters.
- Low leakage current version.
- Help to ensure EMC compliance of machinery and installations using J7 drives on short motor cables, if low leakage current is required.
- Footprint filters mount between the inverter and the panel, saving valuable space inside wiring cabinets.
- All filters are CE marked.

Dimensions

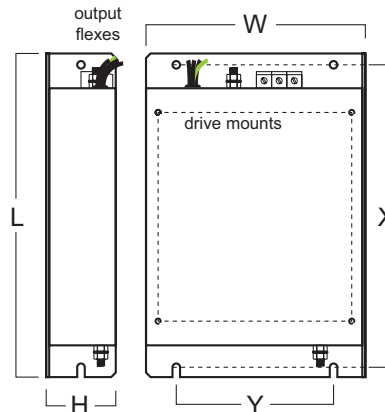

Applied Inverter	Filter Part No	Rated Current	Max Rated Voltage	Leakage current Nom / Max	External L x W x H (mm)	Mount Dims X x Y (mm)	Inverter Fixing
CIMR-J7AAB0P1 CIMR-J7AAB0P2 CIMR-J7AAB0P4	RS 1010-J7(LL)	10A	1ph, 250V	3.5mA	169 x 71 x 45	156 x 51	M4
CIMR-J7AAB0P7 CIMR-J7AAB1P5	RS 1020-J7(LL)	20A	1ph, 250V	3.5mA	169 x 111 x 50	156 x 91	M4
CIMR-J7AA20P1 CIMR-J7AA20P2 CIMR-J7AA20P4 CIMR-J7AA20P7	RS 2010-J7(LL)	10A	3ph, 250V	0.2 / 9mA	194 x 82 x 50	181 x 62	M4
CIMR-J7AA21P5 CIMR-J7AA22P2	RS 2020-J7(LL)	16A	3ph, 250V	0.2 / 9mA	169 x 111 x 50	156 x 91	M4
CIMR-J7AA23P7	RS 2030-J7(LL)	26A	3ph, 250V	0.2 / 14mA	174 x 144 x 50	161 x 120	M4
CIMR-J7AA40P2 CIMR-J7AA40P4	RS 3005-J7(LL)	5A	3ph, 480V	0.3 / 14mA	169 x 111 x 50	156 x 91	M4
CIMR-J7AA40P7 CIMR-J7AA41P5 CIMR-J7AA42P2	RS 3010-J7(LL)	10A	3ph, 480V	0.3 / 14mA	169 x 111 x 50	156 x 91	M4
CIMR-J7AA4030 CIMR-J7AA43P7	RS 3020-J7(LL)	15A	3ph, 480V	0.3 / 14mA	174 x 144 x 50	161 x 120	M4

Typical Circuit Schematics

Single Phase



Three Phase

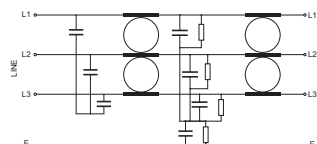

V7

- The **RS-V7** range, especially for Yaskawa V7 Series inverters.
- Help to ensure EMC compliance of machinery and installations using V7 drives.
- Footprint filters mount between the inverter and the panel, saving valuable space inside wiring cabinets.
- All filters are designed and manufactured to UL requirements and are CE marked.



Dimensions

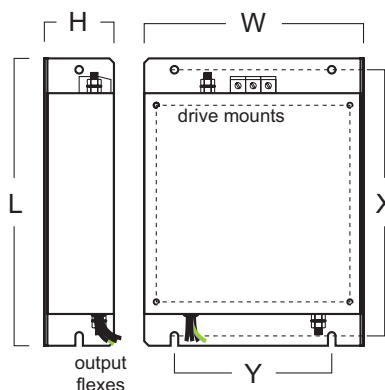

Applied Inverter	Filter Part No	Rated Current	Max Rated Voltage	Leakage current Nom / Max	External L x W x H (mm)	Mount Dims X x Y (mm)	Inverter Fixing	EMC Tested	UL
CIMR-V7AAB0P1 CIMR-V7AAB0P2 CIMR-V7AAB0P4	RS 1010-V7	10A	1ph, 250V	7.0mA	169 x 71 x 45	156 x 51	M4	✓	✓
CIMR-V7AAB0P7 CIMR-V7AAB1P5	RS 1020-V7	20A	1ph, 250V	7.0mA	169 x 111 x 50	156 x 91	M4	✓	✓
CIMR-V7AAB2P2	RS 1030-V7	30A	1ph, 250V	3.5mA	174 x 144 x 50	161 x 120	M4	✓	✓
CIMR-V7AAB4P0	RS 1040-V7	40A	1ph, 250V	3.5mA	174 x 174 x 50	161 x 150	M4	✓	✓
CIMR-V7AA20P1 CIMR-V7AA20P2 CIMR-V7AA20P4 CIMR-V7AA20P7	RS 2010-V7	10A	3ph, 250V	0.3 / 26mA	194 x 82 x 50	181 x 62	M4	✓	✓
CIMR-V7AA21P5 CIMR-V7AA22P2	RS 2020-V7	16A	3ph, 250V	0.3 / 16mA	169 x 111 x 50	156 x 91	M4	✓	✓
CIMR-V7AA23P7	RS 2030-V7	26A	3ph, 250V	0.3 / 17mA	174 x 144 x 50	161 x 120	M4	✓	✓
CIMR-V7AA25P5 CIMR-V7AA27P5	RS 2050-V7	50A	3ph, 250V	0.6 / 57mA	304 x 184 x 56	288 x 150	M5	✓	✓
CIMR-V7AA40P2 CIMR-V7AA40P4 CIMR-V7AA40P7	RS 3005-V7	5A	3ph, 480V	0.5 / 29mA	169 x 111 x 45	156 x 91	M4	✓	✓
CIMR-V7AA41P5 CIMR-V7AA42P2	RS 3010-V7	10A	3ph, 480V	0.5 / 29mA	169 x 111 x 45	156 x 91	M4	✓	✓
CIMR-V7AA43P0 CIMR-V7AA 43P7	RS 3020-V7	15A	3ph, 480V	0.5 / 29mA	174 x 144 x 50	161 x 120	M4	✓	✓
CIMR-V7AA45P5 CIMR-V7AA47P5	RS 3030-V7	30A	3ph, 480V	0.7 / 60mA	304 x 184 x 56	288 x 150	M5	✓	✓

Typical Circuit Schematics

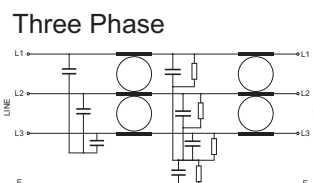
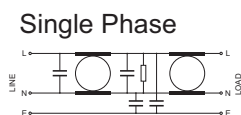

V7(LL)



- The **RS-V7(LL)** range, especially for Yaskawa V7 Series inverters.
- Low leakage current version.
- Help to ensure EMC compliance of machinery and installations using V7 drives on short motor cables, if low leakage current is required.
- Footprint filters mount between the inverter and the panel, saving valuable space inside wiring cabinets.
- All filters are CE marked.

Dimensions

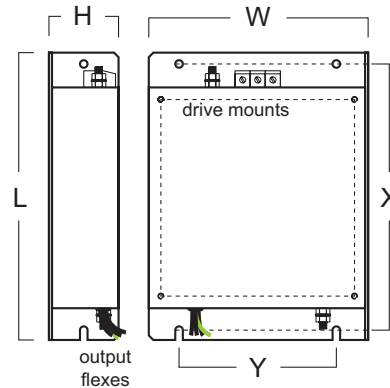

Applied Inverter	Filter Part No	Rated Current	Max Rated Voltage	Leakage current Nom / Max	External L x W x H (mm)	Mount Dims X x Y (mm)	Inverter Fixing
CIMR-V7AAB001 CIMR-V7AAB002 CIMR-V7AAB004	RS 1010-V7(LL)	10A	1ph, 250V	3.5mA	169 x 71 x 45	156 x 51	M5
CIMR-V7AAB007 CIMR-V7AAB015	RS 1020-V7(LL)	20A	1ph, 250V	3.5mA	169 x 111 x 50	156 x 91	M5
CIMR-V7AAB022	RS 1030-V7(LL)	30A	1ph, 250V	1.8mA	174 x 144 x 50	161 x 120	M5
CIMR-V7AAB040	RS 1040-V7(LL)	40A	1ph, 250V	1.8mA	174 x 174 x 50	161 x 150	M5
CIMR-V7AA2001 CIMR-V7AA2002 CIMR-V7AA2004 CIMR-V7AA2007	RS 2010-V7(LL)	10A	3ph, 250V	0.2 / 14mA	194 x 82 x 50	181 x 62	M5
CIMR-V7AA2015 CIMR-V7AA2022	RS 2020-V7(LL)	16A	3ph, 250V	0.2 / 9mA	169 x 111 x 50	156 x 91	M5
CIMR-V7AA2040	RS 2030-V7(LL)	26A	3ph, 250V	0.2 / 9mA	174 x 144 x 50	161 x 120	M5
CIMR-V7AA2055 CIMR-V7AA2075	RS 2050-V7(LL)	50A	3ph, 250V	0.4 / 29mA	304 x 184 x 56	288 x 150	M6
CIMR-V7AA4002 CIMR-V7AA4004 CIMR-V7AA4007	RS 3005-V7(LL)	5A	3ph, 480V	0.3 / 14mA	169 x 111 x 45	156 x 91	M5
CIMR-V7AA4015 CIMR-V7AA4022	RS 3010-V7(LL)	10A	3ph, 480V	0.3 / 14mA	169 x 111 x 45	156 x 91	M5
CIMR-V7AA4030 CIMR-V7AA4040	RS 3020-V7(LL)	15A	3ph, 480V	0.3 / 14mA	174 x 144 x 50	161 x 120	M5
CIMR-V7AA4055 CIMR-V7AA4075	RS 3030-V7(LL)	30A	3ph, 480V	0.5 / 29mA	304 x 184 x 56	288 x 150	M6

Typical Circuit Schematics

Single Phase

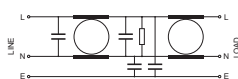

Three Phase

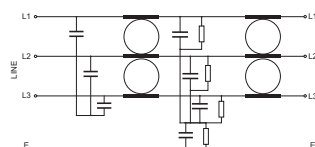

F7 200V



- The **F7 200V** range, especially for Yaskawa F7 and E7 200V Series inverters.
- Help to ensure EMC compliance of machinery and installations using F7 and E7 drives.
- Footprint filters mount between the inverter and the panel, saving valuable space inside wiring cabinets. Block type filters mount beside the inverter.
- All filters are designed and manufactured to UL requirements and are CE marked.

Footprint Dimensions

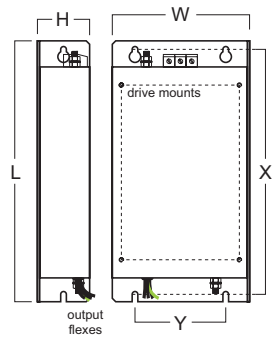

Book Type Dimensions

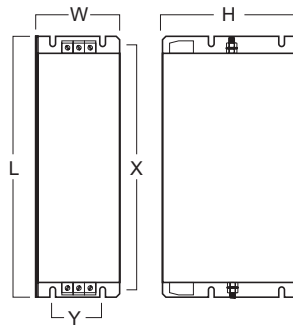

Block Type

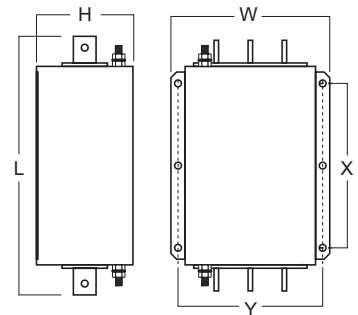

Three Phase 250Vac

Applied F7 Inverter	Applied E7 Inverter	Filter Part No	Rated Current	Leakage current Nom / Max	External L x W x H (mm)	Mount Dims X x Y (mm)	Filter Fixing
CIMR-F7C20P4 CIMR-F7C20P7 CIMR-F7C21P5	CIMR-E7C20P4 CIMR-E7C20P7 CIMR-E7C21P5	RS 3010-F7	10A	0.2mA / 22mA	330 x 143 x 46	313 x 115	M4
CIMR-F7C22P2	CIMR-E7C22P2	RS 3018-F7	18A	0.2mA / 22mA	330 x 143 x 46	313 x 115	M4
CIMR-F7C23P7 CIMR-F7C25P5	CIMR-E7C23P7 CIMR-E7C25P5	RS 2035-F7	35A	0.4mA / 45mA	330 x 143 x 46	313 x 115	M4
CIMR-F7C27P5 CIMR-F7C2011	CIMR-E7C27P5 CIMR-E7C2011	RS 2060-F7	60A	0.7mA / 80mA	355 x 213 x 60	336 x 175	M6
CIMR-F7C2015 CIMR-F7C2018	CIMR-E7C2015 CIMR-E7C2018	RS 2100-F7	100A	0.7mA / 80mA	408 x 238 x 80	390 x 205	M6
CIMR-F7C2022 CIMR-F7C2030	CIMR-E7C2022 CIMR-E7C2030	RS 2130-F7	130A	0.7mA / 80mA	310 x 90 x 180	295 x 65	M6
CIMR-F7C2037	CIMR-E7C2037	RS 2160-F7	160A	1.3mA / 140mA	380 x 120 x 170	365 x 102	M6
CIMR-F7C2045 CIMR-F7C2055	CIMR-E7C2045 CIMR-E7C2055	RS 2200-F7 RS 2250-F7	200A 250A	1.3mA / 140mA 1.3mA / 140mA	518 x 130 x 240 518 x 130 x 240	498 x 90 498 x 90	M8 M8
CIMR-F7C2075	CIMR-E7C2075	RS 3320-F7	320A	5mA / 250mA	518 x 130 x 240	498 x 90	M8
CIMR-F7C2090	CIMR-E7C2090	RS 3400-F7	400A	5mA / 250mA	518 x 130 x 240	498 x 90	M8
CIMR-F7C2110	CIMR-E7C2110	RS 3600-F7	600A	5mA / 250mA	518 x 130 x 240	498 x 90	M8

Typical Circuit Schematic

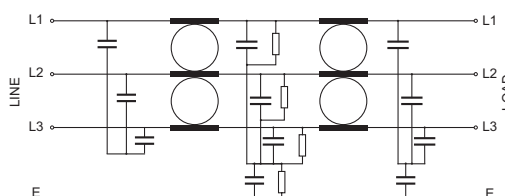

F7 400V



- The **F7 400V** range, especially for Yaskawa F7 and E7 400V Series inverters.
- 200V range also available for Yaskawa F7 and E7 200V Series inverters.
- Help to ensure EMC compliance of machinery and installations using F7 and E7 drives.
- Footprint filters mount between the inverter and the panel, saving valuable space inside wiring cabinets. Block type filters mount beside the inverter.
- All filters are designed and manufactured to UL requirements and are CE marked.

Footprint Dimensions

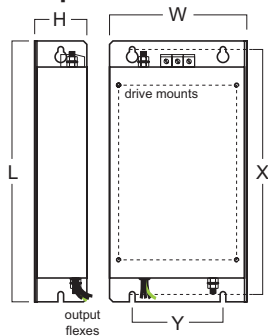

Book Type Dimensions

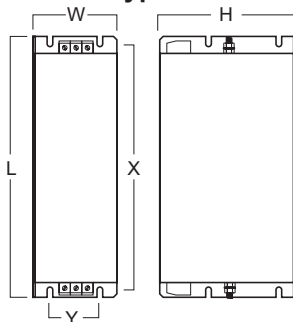

Block Type

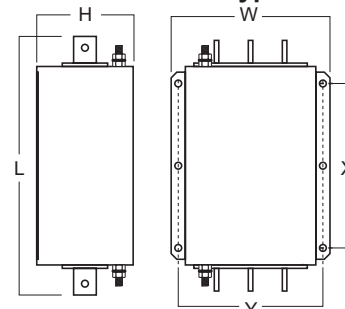

Three Phase 480Vac

Applied F7 Inverter	Applied E7 Inverter	Filter Part No	Rated Current	Leakage current Nom / Max	External L x W x H (mm)	Mount Dims X x Y (mm)	Filter Fixing
CIMR-F7C40P4 CIMR-F7C40P7 CIMR-F7C41P5 CIMR-F7C42P2	CIMR-E7C40P4 CIMR-E7C40P7 CIMR-E7C41P5 CIMR-E7C42P2	RS 3010-F7	10A	0.3mA / 40mA	330 x 143 x 46	313 x 115	M5
CIMR-F7C43P7 CIMR-F7C45P5	CIMR-E7C43P7 CIMR-E7C45P5	RS 3018-F7	18A	0.3mA / 40mA	330 x 143 x 46	313 x 115	M5
CIMR-F7C47P5 CIMR-F7C4011	CIMR-E7C47P5 CIMR-E7C4011	RS 3035-F7	35A	0.3mA / 40mA	355 x 213 x 51	336 x 175	M6
CIMR-F7C4015 CIMR-F7C4018	CIMR-E7C4015 CIMR-E7C4018	RS 3060-F7	60A	0.3mA / 40mA	408 x 238 x 60	390 x 205	M6
CIMR-F7C4022 CIMR-F7C4030	CIMR-E7C4022 CIMR-E7C4030	RS 3070-FP7	70A	0.3mA / 40mA	508 x 275 x 65	490 x 220	M6
CIMR-F7C4037 CIMR-F7C4045	CIMR-E7C4037 CIMR-E7C4045	RS 3100-FP7	100A	0.3mA / 40mA	631 x 330 x 65	609 x 260	M6
CIMR-F7C4055	CIMR-E7C4055	RS 3130-FP7	130A	3mA / 250mA	661 x 330 x 110	631 x 260	M6
CIMR-F7C4022 CIMR-F7C4030	CIMR-E7C4022 CIMR-E7C4030	RS 3070-F7	70A	0.6mA / 72mA	329 x 80 x 220	314 x 55	M6
CIMR-F7C4037 CIMR-F7C4045	CIMR-E7C4037 CIMR-E7C4045	RS 3100-F7	100A	1.3mA / 150mA	310 x 90 x 180	295 x 65	M6
CIMR-F7C4055	CIMR-E7C4055	RS 3130-F7	130A	1.3mA / 150mA	310 x 90 x 180	295 x 65	M6
CIMR-F7C4075	CIMR-E7C4075	RS 3170-F7	170A	2.5mA / 270mA	380 x 120 x 180	365 x 102	M6
CIMR-F7C4090	CIMR-E7C4090	RS 3200-F7	200A	2.5mA / 270mA	518 x 130 x 240	498 x 90	M8
CIMR-F7C4110	CIMR-E7C4110	RS 3250-F7	250A	2.5mA / 270mA	518 x 130 x 240	498 x 90	M8
CIMR-F7C4132	CIMR-E7C4132	RS 3320-F7	320A	10mA / 500mA	386 x 260 x 135	240 x 235	M10
CIMR-F7C4160	CIMR-E7C4160	RS 3400-F7	400A	10mA / 500mA	386 x 260 x 135	240 x 235	M10
CIMR-F7C4220	CIMR-E7C4220	RS 3600-F7	600A	10mA / 500mA	386 x 260 x 135	240 x 235	M10
CIMR-F7C4300	CIMR-E7C4300	RS 3800-F7	800A	10mA / 500mA	456 x 280 x 150	290 x 255	M10

Typical Circuit Schematic

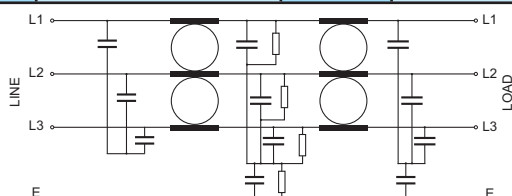

F7 400V (LL)



- The **F7 400V (LL)** range, especially for Yaskawa F7 and E7 400V Series inverters.
- 200V range also available for Yaskawa F7 and E7 200V Series inverters.
- Low leakage current version.
- Help to ensure EMC compliance of machinery and installations using F7 and E7 drives on short motor cables, if low leakage current is required.
- Footprint filters mount between the inverter and the panel, saving valuable space inside wiring cabinets. Block type filters mount beside the inverter.
- All filters are designed and manufactured to UL requirements and are CE

Footprint Dimensions

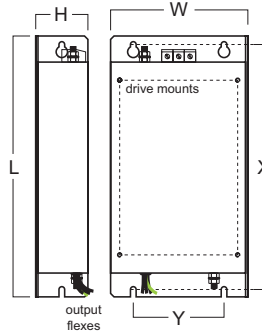

Book Type Dimensions

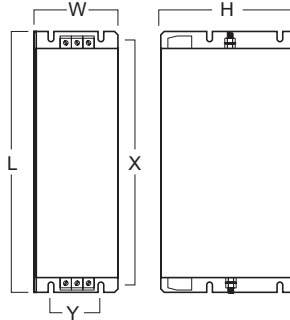

Block Type

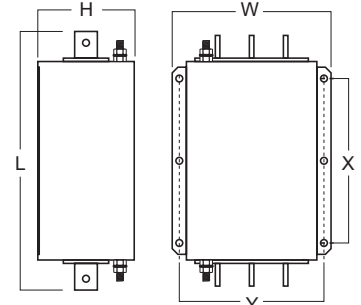

Three Phase 480Vac

Applied F7 Inverter	Applied E7 Inverter	Filter Part No	Rated Current	Leakage current Nom / Max	External L x W x H (mm)	Mount Dims X x Y (mm)	Filter Fixing
CIMR-F7C40P4 CIMR-F7C40P7 CIMR-F7C41P5 CIMR-F7C42P2	CIMR-E7C40P4 CIMR-E7C40P7 CIMR-E7C41P5 CIMR-E7C42P2	RS 3010-F7(LL)	10A	0.2mA / 20mA	330 x 143 x 46	313 x 115	M5
CIMR-F7C43P7 CIMR-F7C45P5	CIMR-E7C43P7 CIMR-E7C45P5	RS 3018-F7(LL)	18A	0.2mA / 20mA	330 x 143 x 46	313 x 115	M5
CIMR-F7C47P5 CIMR-F7C4011	CIMR-E7C47P5 CIMR-E7C4011	RS 3035-F7(LL)	35A	0.2mA / 20mA	355 x 213 x 51	336 x 175	M6
CIMR-F7C4015 CIMR-F7C4018	CIMR-E7C4015 CIMR-E7C4018	RS 3060-F7(LL)	60A	0.2mA / 20mA	408 x 238 x 60	390 x 205	M6
CIMR-F7C4022 CIMR-F7C4030	CIMR-E7C4022 CIMR-E7C4030	RS 3070-FP7(LL)	70A	0.2mA / 20mA	508 x 275 x 65	490 x 220	M6
CIMR-F7C4037 CIMR-F7C4045	CIMR-E7C4037 CIMR-E7C4045	RS 3100-FP7(LL)	100A	0.2mA / 20mA	631 x 330 x 65	609 x 260	M6
CIMR-F7C4055	CIMR-E7C4055	RS 3130-FP7(LL)	130A	2mA / 125mA	661 x 330 x 110	631 x 260	M6
CIMR-F7C4022 CIMR-F7C4030	CIMR-E7C4022 CIMR-E7C4030	RS 3070-F7(LL)	70A	0.3mA / 40mA	329 x 80 x 220	314 x 55	M6
CIMR-F7C4037 CIMR-F7C4045	CIMR-E7C4037 CIMR-E7C4045	RS 3100-F7(LL)	100A	0.8mA / 75mA	310 x 90 x 180	295 x 65	M6
CIMR-F7C4055	CIMR-E7C4055	RS 3130-F7(LL)	130A	0.8mA / 75mA	310 x 90 x 180	295 x 65	M6
CIMR-F7C4075	CIMR-E7C4075	RS 3170-F7(LL)	170A	1.3mA / 130mA	380 x 120 x 180	365 x 102	M6
CIMR-F7C4090	CIMR-E7C4090	RS 3200-F7(LL)	200A	1.3mA / 130mA	518 x 130 x 240	498 x 90	M8
CIMR-F7C4110	CIMR-E7C4110	RS 3250-F7(LL)	250A	1.3mA / 130mA	518 x 130 x 240	498 x 90	M8
CIMR-F7C4132	CIMR-E7C4132	RS 3320-F7(LL)	320A	5mA / 250mA	386 x 260 x 135	240 x 235	M10
CIMR-F7C4160	CIMR-E7C4160	RS 3400-F7(LL)	400A	5mA / 250mA	386 x 260 x 135	240 x 235	M10
CIMR-F7C4220	CIMR-E7C4220	RS 3600-F7(LL)	600A	5mA / 250mA	386 x 260 x 135	240 x 235	M10
CIMR-F7C4300	CIMR-E7C4300	RS 3800-F7(LL)	800A	5mA / 250mA	456 x 280 x 150	290 x 255	M10

Typical Circuit Schematic

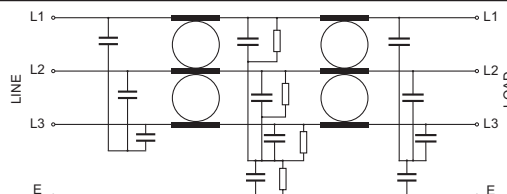

G5



- The **RS-G5** range, especially for Yaskawa G5 and P5 Series inverters.
- Help to ensure EMC compliance of machinery and installations using G5 and P5 drives.
- Footprint filters mount between the inverter and the panel, saving valuable space inside wiring cabinets. Block type filters mount beside the inverter.
- All filters are designed and manufactured to UL requirements and are CE marked.

Footprint Dimensions

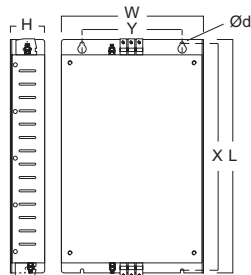

Block Type Dimensions

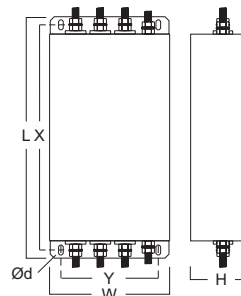

Three Phase 480Vac

Applied G5 Inverter	Applied P5 Inverter	Filter Part No	Rated Current	Leakage current Nom / Max	External L x W x H (mm)	Mount Dims X x Y (mm)	Filter Fixing	EMC Tested
CIMR-G5E40P4 CIMR-G5E40P7 CIMR-G5E41P5		RS 3008-G5	8A	0.5 / 40mA	320 x 143 x 46	309 x 90	M4	✓
CIMR-G5E42P2 CIMR-G5E43P7	CIMR-P5E43P7	RS 3020-G5	20A	0.5 / 40mA	320 x 143 x 46	309 x 90	M4	✓
CIMR-G5E45P5 CIMR-G5E47P5	CIMR-P5E45P5 CIMR-P5E47P5	RS 3030-G5	30A	0.5 / 40mA	350 x 213 x 51	332 x 150	M6	✓
CIMR-G5E4011 CIMR-G5E4015	CIMR-P5E4011 CIMR-P5E4015	RS 3060-G5	60A	0.5 / 40mA	435 x 268 x 56	415 x 200	M6	✓
CIMR-G5E4018 CIMR-G5E4022	CIMR-P5E4018 CIMR-P5E4022	RS 3080-G5	80A	0.5 / 40mA	365 x 180 x 90	338 x 146	M6	✓
CIMR-G5E4030	CIMR-P5E4030	RS 3100-G5	100A	1.3 / 150mA	435 x 200 x 130	408 x 166	M6	✓
CIMR-G5E4037	CIMR-P5E4037	RS 3150-G5	150A	1.3 / 150mA	495 x 200 x 160	338 x 146	M6	✓
CIMR-G5E4045	CIMR-P5E4045	RS 3160-G5	160A	1.3 / 150mA	495 x 200 x 160	408 x 166	M6	✓
CIMR-G5E4055	CIMR-P5E4055	RS 3180-G5	180A	1.3 / 150mA	495 x 200 x 160	408 x 166	M6	✓
CIMR-G5E4075 CIMR-G5E4110	CIMR-P5E4075 CIMR-P5E4110	RS 3300-G5	300A	1.3 / 150mA	587 x 250 x 205	468 x 166	M6	✓
CIMR-G5E4160	CIMR-P5E4160	RS 3400-G5	400A	1.3 / 150mA	587 x 250 x 205	468 x 166	M6	✓
CIMR-G5E4185 CIMR-G5E4220	CIMR-P5E4185 CIMR-P5E4220	RS 3600-G5	600A	3.0 / 250mA	688 x 364 x 180	560 x 170	M6	✓
CIMR-G5E4300	CIMR-P5E4300	RS 3900-G5	900A	3.0 / 250mA	688 x 364 x 180	648 x 300	M8	✓

Typical Circuit Schematic

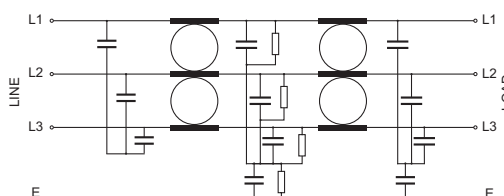

Sigma-II



- The **RS-SG** range, especially for Yaskawa Σ -II Series AC servo drives.
- Help to ensure EMC compliance of machinery and installations using Σ -II drives.
- Footprint filters mount between the servo drive and the panel, saving valuable space inside wiring cabinets.
- All filters are designed and manufactured to UL requirements and are CE marked.

Footprint Dimensions

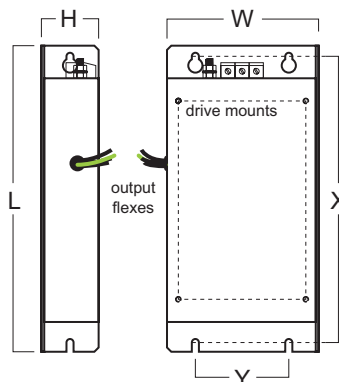

Applied Servo Drive	Filter Part No	Rated Current	Max Rated Voltage	Leakage current Nom / Max	External L x W x H (mm)	Mount Dims X x Y (mm)	Filter Fixing	UL
SGDH-A3E SGDH-A5E SGDH-01E SGDH-02E	RS 1004-SG	4A	1ph, 250V	3.5mA	202 x 55 x 32	192 x 33	M4	✓
SGDH-04E	RS 1007-SG	7A	1ph, 250V	3.5mA	202 x 75 x 32	192 x 50	M4	✓
SGDH-08E-S	RS 1015-SG	15A	1ph, 250V	3.5mA	202 x 90 x 32	192 x 60	M4	●
SGDH-15E-S	RS 1025-SG	25A	1ph, 250V	3.5mA	291 x 118 x 35	281 x 80	M4	●
SGDH05DE SGDH10DE SGDH-15DE	RS 3006-SG	6A	3ph, 480V	0.3mA / 33mA	202 x 118 x 32	192 x 80	M4	✓
SGDH-20DE SGDH-30DE	RS 3010-SG	10A	3ph, 480V	0.3mA / 33mA	291 x 118 x 35	281 x 80	M4	✓
SGDH-50DE	RS 3018-SG	18A	3ph, 480V	0.3mA / 40mA	291 x 143 x 45	281 x 105	M4	✓
SGDH-60DE SGDH-75DE	RS 3024-SG	24A	3ph, 480V	0.3mA / 40mA	400 x 230 x 52	390 x 160	M6	✓

UL Approval Status - ✓ Complete, ● Pending

Typical Circuit Schematics

Single Phase

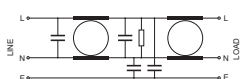

Three Phase

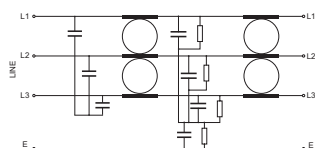

UL approval documentation and EMC Test Certificates from Independent Test House

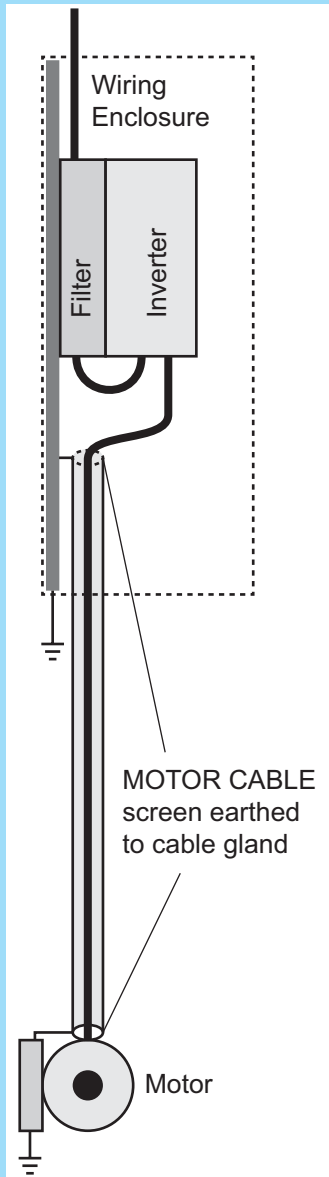

Filter Installation Notes

To conform to EMC directives, it is essential that good wiring practice is observed and that all installation recommendations are followed.

- ◆ The usual safety procedures when working with electrical equipment must be followed and all electrical connections to the filter, inverter & motor must be made by a qualified electrical technician.
- ◆ Filters should be fitted as closely as possible to the incoming mains supply of the wiring enclosure, usually directly after the enclosures circuit breaker or supply switch.
- ◆ Care should be taken to remove any paint etc. from filter and inverter mounting holes and face area of the panel to ensure the best possible earthing of the units.
- ◆ All lead lengths should be kept as short as possible and incoming mains, outgoing motor cables and control cables should be kept well separated. Cable earth screens should only be stripped back as far as necessary to make connections - screens should be securely earth bonded to the wiring panel.

DUE TO CONTINUAL PRODUCT DEVELOPMENT, SPECIFICATIONS SUBJECT TO CHANGE WITHOUT NOTICE



RASMI ELECTRONICS LTD.
Morrison Road, Annfield Plain, Stanley, Co. Durham DH9 7RX, England.
email: sales@rasmi.com Tel: +44 (0)1207 291300 Fax: +44 (0)1207 291304



Artisan Scientific

QUALITY INSTRUMENTATION ... GUARANTEED

Looking for more information?

Visit us on the web at <http://www.artisan-scientific.com> for more information:

- Price Quotations
- Drivers
- Technical Specifications, Manuals and Documentation

Artisan Scientific is Your Source for Quality New and Certified-Used/Pre-owned Equipment

- Tens of Thousands of In-Stock Items
- Hundreds of Manufacturers Supported
- Fast Shipping and Delivery
- Leasing / Monthly Rentals
- Equipment Demos
- Consignment

Service Center Repairs

Experienced Engineers and Technicians on staff in our State-of-the-art Full-Service In-House Service Center Facility

InstraView™ Remote Inspection

Remotely inspect equipment before purchasing with our Innovative InstraView™ website at <http://www.instraview.com>

We buy used equipment! We also offer credit for Buy-Backs and Trade-Ins

Sell your excess, underutilized, and idle used equipment. Contact one of our Customer Service Representatives today!

Talk to a live person: 888-88-SOURCE (888-887-6872) | Contact us by email: sales@artisan-scientific.com | Visit our website: <http://www.artisan-scientific.com>