



Artisan Technology Group is your source for quality new and certified-used/pre-owned equipment

- FAST SHIPPING AND DELIVERY
- TENS OF THOUSANDS OF IN-STOCK ITEMS
- EQUIPMENT DEMOS
- HUNDREDS OF MANUFACTURERS SUPPORTED
- LEASING/MONTHLY RENTALS
- ITAR CERTIFIED SECURE ASSET SOLUTIONS

SERVICE CENTER REPAIRS

Experienced engineers and technicians on staff at our full-service, in-house repair center

*InstraView*SM REMOTE INSPECTION

Remotely inspect equipment before purchasing with our interactive website at www.instraview.com ↗

WE BUY USED EQUIPMENT

Sell your excess, underutilized, and idle used equipment. We also offer credit for buy-backs and trade-ins. www.artisanng.com/WeBuyEquipment ↗

LOOKING FOR MORE INFORMATION?

Visit us on the web at www.artisanng.com ↗ for more information on price quotations, drivers, technical specifications, manuals, and documentation

Contact us: (888) 88-SOURCE | sales@artisanng.com | www.artisanng.com



6502B RF Distribution

User Guide

Revision B - April 2009

Part Number 15247-201

Table of Contents

About this User Guide.....	1
Purpose	1
Conventions	1
Special Notices	2
Customer Assistance	3
Notices	3
Symmetricom Limited Product Warranty	4
Introduction.....	5
Overview	5
Purpose of Equipment	5
Instrument Identification.....	5
Preparation for Shipment	5
Installation.....	7
Mounting.....	7
Power Connection/Fuses/Voltage	7
DC Power Connection	9
Signal Connectors.....	9
Daisy Chaining More Than One Module	9
Alarm Connections.....	10
Operation.....	11
Overview	11
Controls and Indicators	11
HI Z/50Ω.....	11
ALARM OVERRIDE.....	11
POWER.....	11
ALARM	12
INPUT FAULT.....	12
Specifications.....	13
Additive SSB Phase Noise (1 Hz BW).....	13
RF Outputs (10).....	13
RF Input	13
Power.....	14
Mechanical	14

Environment.....	14
Alarm Output	14
Controls and Indicators	14
Available Versions	15
Index	17

About this User Guide

Purpose

The 6502B User Guide describes the procedures for unpacking, installing, using, maintaining, and troubleshooting the 6502B.

Conventions

This guide uses the following conventions:

- **Acronyms and Abbreviations** – Terms are spelled out the first time they appear in text. Thereafter, only the acronym or abbreviation is used.
- **Revision Control** – The title page lists the printing date and versions of the product this guide describes.
- **Typographical Conventions** – This guide uses the typographical conventions described in the table below.

When text appears this way...	... it means:
<i>TimeProvider User's Guide</i>	The title of a document.
SSU CRITICAL	An operating mode, alarm state, status, or chassis label.
Select File , Open ...	Click the Open option on the File menu.
Press Enter Press ;	A named keyboard key. The key name is shown as it appears on the keyboard. An explanation of the key's acronym or function immediately follows the first reference to the key, if required.
6502 Username:	Text in a source file or a system prompt or other text that appears on a screen.
<i>A re-timing</i> application	A word or term being emphasized.
Symmetricom does not recommend...	A word or term given special emphasis.

Special Notices

Warnings, Cautions, Recommendations, and Notes attract attention to essential or critical information in this guide. The types of information included in each are explained in the following examples.



Warning: To avoid serious personal injury or death, *do not* disregard warnings. All warnings use this symbol. Warnings are installation, operation, or maintenance procedures, practices, or statements, that if not strictly observed, may result in serious personal injury or even death.



Caution: To avoid personal injury, *do not* disregard cautions. All cautions use this symbol. Cautions are installation, operation, or maintenance procedures, practices, conditions, or statements, that if not strictly observed, may result in damage to, or destruction of, the equipment. Cautions are also used to indicate a long-term health hazard.



ESD Caution: To avoid personal injury and electrostatic discharge (ESD) damage to equipment, *do not* disregard ESD cautions. All ESD cautions use this symbol. ESD cautions are installation, operation, or maintenance procedures, practices, conditions, or statements that if not strictly observed, may result in possible personal injury, electrostatic discharge damage to, or destruction of, static sensitive components of the equipment.



Electrical Shock Caution: To avoid electrical shock and possible personal injury, do not disregard electrical shock cautions. All electrical shock cautions use this symbol. Electrical shock cautions are practices, procedures, or statements, that if not strictly observed, may result in possible personal injury, electrical shock damage to, or destruction of components of the equipment.



Recommendation: All recommendations use this symbol. Recommendations indicate manufacturer-tested methods or known functionality. Recommendations contain installation, operation, or maintenance procedures, practices, conditions, or statements, that provide important information for optimum performance results.



Note: All notes use this symbol. Notes contain installation, operation, or maintenance procedures, practices, conditions, or statements, that alert you to important information, which may make your task easier or increase your understanding

Customer Assistance

For additional information about the products described in this guide, please contact your Symmetricom representative or your local sales office.

For Customer Assistance, please contact us by phone, e-mail, or on the web at www.symmetricom.com/support/.

Symmetricom - Timing, Test & Measurement Division
34 Tozer Road
Beverly, MA 01915-5510

US Toll Free: 1-888-367-7966
Phone: 1-978-927-8220
E-mail: support@symmetricom.com

Notices

Symmetricom, Inc.
Timing Test & Measurement
3750 Westwind Blvd.
Santa Rosa, CA 95403-1053
<http://www.symmetricom.com>

Copyright © 2004 Symmetricom, Inc.
All rights reserved. Printed in U.S.A.

All product names, service marks, trademarks, and registered trademarks used in this document are the property of their respective owners.

Symmetricom Limited Product Warranty

1. Hardware and embedded software - For a period of one (1) year from date of shipment by Symmetricom, Symmetricom warrants that all Products shall be free from defects in design, material, and workmanship; shall conform to and perform in accordance with Symmetricom's published specifications, if any; shall be free and clear of any liens and encumbrances; and shall have good and valid title. This warranty will survive inspection, acceptance, and payment by Buyer. Symmetricom does not warrant that the operation of such Products will be uninterrupted or error free. This warranty does not cover failures caused by acts of God, electrical or environmental conditions; abuse, negligence, accident, loss or damage in transit; or improper site preparation.

This warranty shall be null and void in the event (i) Buyer or any third party attempts repair of the goods without Symmetricom's advance written authorization, or (ii) defects are the result of improper or inadequate maintenance by Buyer or third party; (iii) of damage to said goods by Buyer or third party-supplied software, interfacing or supplies; (iv) of improper use (including termination of non-certified third party equipment on Symmetricom's proprietary interfaces and operation outside of the product's specifications) by Buyer or third party; or (v) the goods are shipped to any country other than that originally specified in the Buyer's purchase order.

Goods not meeting the foregoing warranty will be repaired or replaced, at Symmetricom's option, upon return to Symmetricom's factory freight prepaid; provided, however that Buyer has first obtained a return materials authorization number ("RMA Number") from Symmetricom authorizing such return. The RMA Number shall be placed on the exterior packaging of all returns. Symmetricom will pay shipping costs to return repaired or replacement goods to Buyer.

Symmetricom reserves the right to disallow a warranty claim following an inspection of returned product. When a warranty claim is questioned or disallowed, Symmetricom will contact Buyer by telephone or in writing to resolve the problem.

2. Software - Symmetricom warrants that for a period of ninety (90) days from date of shipment by Symmetricom the accompanying media will be free from defects in materials and workmanship under normal use. The physical media warranty does not apply to defects arising from misuse, theft, vandalism, fire, water, acts of God or other similar perils. Symmetricom will not be liable for any damages caused by the Buyer's failure to fulfill its responsibilities as stated above.

3. THE FOREGOING WARRANTY IS IN LIEU OF ALL OTHER WARRANTIES, EXPRESSED OR IMPLIED, INCLUDING, BUT NOT LIMITED TO, ANY IMPLIED WARRANTIES OF TITLE, MERCHANTABILITY, OR FITNESS FOR A PARTICULAR PURPOSE HOWSOEVER ARISING.

4. Limitation of Liability - The remedies provided herein are the Buyer's sole and exclusive remedies. In no event or circumstances will Symmetricom be liable to Buyer for indirect, special, incidental or consequential damages, including without limitation, loss of revenues or profits, business interruption costs, loss of data or software restoration, or damages relating to Buyer's procurement of substitute products or services. Except for liability for personal injury or property damage arising from Symmetricom's negligence or willful misconduct, in no event will Symmetricom's total cumulative liability in connection with any order hereunder or Symmetricom's Goods, from all causes of action of any kind, including tort, contract, negligence, strict liability and breach of warranty, exceed the total amount paid by Buyer hereunder. SOME JURISDICTIONS DO NOT ALLOW CERTAIN LIMITATIONS OR EXCLUSIONS OF LIABILITY, SO THE ABOVE LIMITATIONS OR EXCLUSIONS MAY NOT APPLY TO ALL BUYERS.

Introduction

Overview

This manual contains procedures and descriptive information for proper installation and operation of the Symmetricom 6502B RF Distribution Module.

The 6502B RF Distribution Module takes a single output signal of a frequency source, like a cesium frequency standard, and provides additional buffered outputs, ten per module. This manual contains the information needed to install, configure, and use the 6502B.

Purpose of Equipment

The Symmetricom 6502B RF Distribution Module uses Symmetricom's high performance distribution technology created for its line of cesium standards. The 1U (1.75" high) chassis houses a set of very low noise and high isolation RF amplifiers. Up to ten Symmetricom 6502B RF Distribution Modules may be daisy chained to provide up to 100 independently buffered outputs of the common input. The level of the input signal and all ten output signals are monitored, providing a visual indicator of signal presence as well as a summary fault (form-C relay) for each module.

A complete list of performance characteristics is provided in Chapter Four.

Instrument Identification

The model number 6502B may be followed by a slash (/) and a three-digit number to indicate an option that is supplied within the instrument.

Preparation for Shipment

To turn off the Symmetricom 6502B prior to shipment, remove the AC power from the plug on the rear panel. Package the instrument in its original packing if possible. If the original packing materials are not available, pack in a reinforced cardboard carton using foam to take up any space inside the carton. Do not use foam popcorn or crushed paper for packing.

If the instrument is being returned to Symmetricom, contact the Service Department at (978) 927-8220 to advise of the product return.

Installation

Mounting

The Symmetricom 6502B is designed to be mounted in a standard 19-inch equipment rack and takes up 1 U of vertical space (1.75"). The chassis depth is 12 inches.

Power Connection/Fuses/Voltage

The Symmetricom 6502B is powered from an AC source by a detachable power supply cord. The power cord is the disconnect device. Refer to Chapter Four for power supply requirements. The AC fuses are located inside the AC connector/filter. The hot and neutral lines are fused separately. To change fuses, refer to Figure 1. Open the cover on the AC connector/filter by applying a screwdriver to the cover slot. Once the cover is open, each fuse holder may be removed for inspection or replacement. Replace only with a 0.2A, 250V Slow Blow as specified in Chapter four.

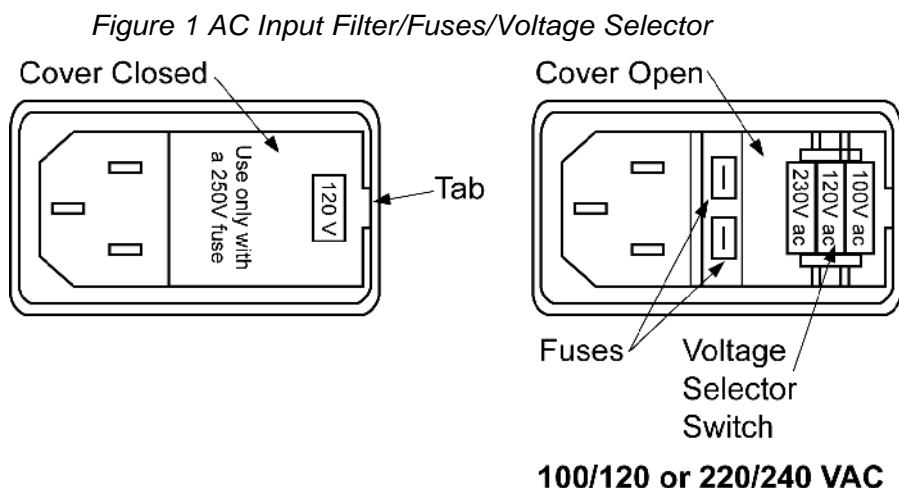

The Symmetricom 6502B may be powered from 100/120 or 220/240 VAC. To change the AC input between 100/120 and 220/240 V, refer to Figure 1. Open the cover on the AC input connector by applying a screwdriver to the cover slot. Once the cover is open, a selector switch may be rolled left or right to line up "120" or "240" with the small window in the connector cover. Replace the cover on the AC input connector by snapping it in place.



Caution 1: Do not use the voltages labeled "100" or "230", as they are not connected.



Caution 2: This instrument must be operated only as specified by the manufacturer. Use other than as specified may compromise the safety precautions of the system.

DC Power Connection

The Symmetricom 6502B (DC version) is powered from a DC source. The connections are made at TB1 as shown in Figure 2. The voltage input may be 20 V to 75 V.

Figure 2 DC Power Connection

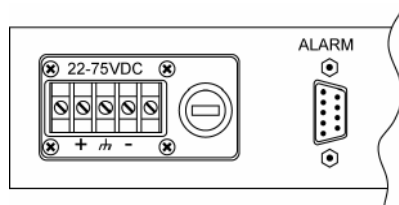

Signal Connectors

Connect the signal to be distributed to one of the two BNC connectors labeled INPUT. Set the impedance switch to 50 Ω (down) if only one 6502B module is to be used. If multiple 6502B modules are used to obtain more than ten outputs, see Figure 4.

Output cables may be connected in any order to the BNC connectors labeled 1 to 12. Refer to Figure 3.

Figure 3 Signal Connections

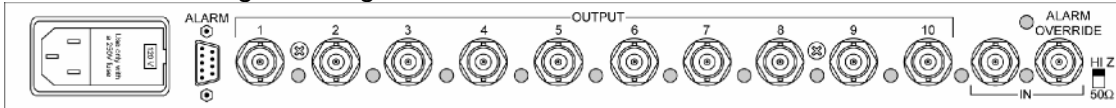

With the 6502B powered, the green power indicator on the front panel will illuminate. The impedance switch should be set to 50 Ω if there is only one module. The red indicator next to the input signal is off to show that there is a good input signal.

Daisy Chaining More Than One Module

If more than ten outputs are required, up to ten Symmetricom 6502B modules can be driven by a common input signal to produce up to 100 outputs. Figure 4 illustrates this connection.

Figure 4. Daisy Chaining Multiple Modules

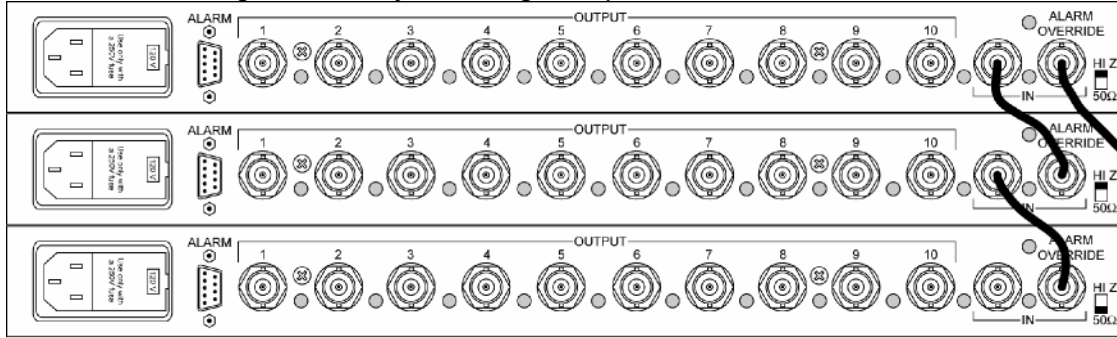

The example in Figure 4 shows three units. The original signal from the source is connected to the top IN connector on the right side of the first module. The lower IN connector on the first module is connected to the top IN connector on the second module. The second module is connected to the third module in the same fashion. The impedance switch for the first and second chassis is set to HI Z, while the impedance switch on the third (or last) chassis in the daisy chain is set to 50Ω.

Alarm Connections

The Symmetricom 6502B provides for an alarm to signal the failure of any signal output. One set of form-C relay contacts is provided on the 9-pin D connector labeled ALARMS. For normal operation, pins 1 to 2 are open and pins 1 to 3 are closed. The sense is reversed for a fault condition. Refer to Figure 5.

Figure 5. Alarm Contacts

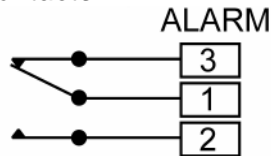

Relay shown in non-faulted condition

If the input signal or input buffer fails or falls below the factory-set low-level threshold, the red fault indicator next to the input connector will turn on. Likewise, if any output buffer fails or falls below the low-level threshold, a red fault indicator next to that output will turn on. The ALARM form-C relay is normally energized, indicating no signal failure. If either the input or any output signal fails, the relay is de-energized (short between pins 1 and 2), indicating a fault condition. This is a fail-safe design that will indicate a fault in the event of a power loss.

Operation

Overview

The Symmetricom 6502B RF Distribution controls and indicators are described in this chapter.

Figure 6: 6502B Distribution Front Panel

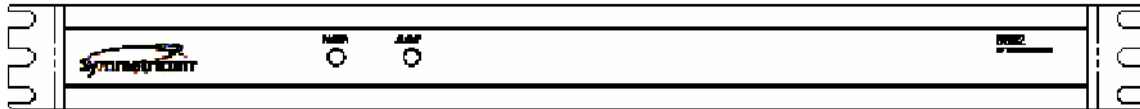
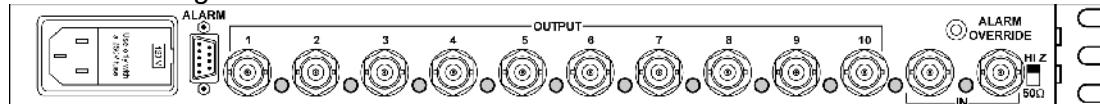

Figure 7: 6502B Distribution Rear Panel



Controls and Indicators

HI Z/50 Ω

This slide switch on the rear panel selects either the HI Z input impedance (unterminated) or the 50 Ω input impedance. A 6502 installation of two or more (ten maximum) units will set the switch to HI Z position on the module connected to the source of the signal, and on all subsequent modules except the last module, which is switched to the 50 Ω position, providing proper termination for the signal.

ALARM OVERRIDE

When provided, the optional ALARM OVERRIDE toggle switch enables or disables the ALARM relay output on the ALARM connector. This makes ALARM OVERRIDE useful for suppressing audible alarms.

With ALARM OVERRIDE in the UP position, the ALARM relay is enabled and changes states in the event of a signal failure. With ALARM OVERRIDE in the DOWN position, the ALARM relay is disabled, forcing it into a normal (no alarm) condition. ALARM OVERRIDE doesn't affect the LED indicators.

POWER

LED on the front panel to indicate that power is applied. There is no power switch on the 6502B. When power is connected, power is ON.

ALARM

LED on the front panel to indicate that an ALARM condition exists. An alarm condition exists when the input signal or any output signal fails or falls below the factory preset amplitude.

INPUT FAULT

This LED is located on the rear panel between the two INPUT connectors. If the input signal fails or falls below the factory preset amplitude, this LED will light and stay on until the cause of the fault is remedied.

OUTPUT FAULT

There are ten LED indicators, located to the right of each output connector. If any output signal fails or falls below the factory preset amplitude, the LED associated with the failed output will light and stay on until the cause of the fault is remedied.

Specifications



Note: All performance is at an ambient temperature of 25°C unless otherwise specified

Additive SSB Phase Noise (1 Hz BW)

(1 Hz Bandwidth) Offset from Carrier

1 Hz	-120 dB
10 Hz	-135 dB
100 Hz	-145 dB
1,000 Hz	-155 dB
10,000 Hz	-160 dB

RF Outputs (10)

Frequency	0.1 to 10 MHz
Level	1 V rms (nominal)
Harmonic Distortion	< -40 dB
Non-Harmonic Signals	< -80 dB
Load Impedance	50 Ω
Isolation	>100 dB*
Connectors	BNC

*Isolation between channel one to ten > 130 dB

RF Input

Frequency	0.1 to 10 MHz
Level	1 V rms (nominal), $\pm 10\%$

Power

Operating Voltage	100 – 120 / 180 - 240 VAC, $\pm 10\%$, 50/60 Hz., 0.1/0.05 A <10 W
DC Input (Optional)	22 to 56 VDC, 10 W
Fuse Type	Little fuse, slow blow, 2/10A, 250V, 5x20mm

Mechanical

Height	1.75" (1 U)
Width	19" (including rack mount ears)
Depth	12"

Environment

Operating Temperature	0 to 55°C
Relative Humidity	0 to 95%, non-condensing
Overvoltage	Category II
Pollution	Degree 2
Intended for INDOOR USE ONLY	
Altitude	Up to 2000 M

Alarm Output

Summary alarm indicates failure of any output signal.	
Each Output & Main	Red LED
Non-alarm Condition	Relay energized (fail safe) Form-C Contacts
Alarm O/P Disable	Optional rear panel switch
Connector	9 pin D-male

Controls and Indicators

POWER	Green LED indicates power is connected
ALARM	Red LED indicates a signal output failure
HI Z/50.	Slide switch: Unterminated or 50. Terminated
ALARM OVERRIDE (Optional)	Toggle switch: Alarm output enabled or disabled
INPUT FAULT	Red LED indicates fault with input signal
OUTPUT FAULT	Ten red LEDs indicate fault with output
See "Controls and Indicators" on page 11 for more information.	



Note: If the input signal level is less than 10 dBm, please specify the Low Alarm Threshold version (-509).

Available Versions

14364-101	Standard configuration, AC input
14364-102	Standard configuration, DC input
14364-109	OdBM Input threshold, DC input
14364-116	Standard configuration, AC input, rear-panel ALARM OVERRIDE switch

Index

A

Additive SSB Phase Noise 13
ALARM 12
Alarm Connections 9
Alarm Output 14
ALARM OVERRIDE 11

C

Caution 2
Controls 11.14
Copyright 2
Customer Assistance 3

D

Daisy Chaining 8
DC Power Connection 8

E

Electrical Shock Caution 2
Environment 14
ESD Caution 2

F

Fuses 7

H

HI Z/50 Ohm 11

I

Indicator 14
Indicators 11.14
INPUT FAULT 12.14
Installation 7
Instrument Identification 5
Introduction 5

M

Mechanical 14
Mounting 7

N

Note 3

O

Operation 11

OUTPUT FAULT 12

P

POWER 11

Power 14

Power Connection 7

Preparation for Shipment 5

Purpose of Equipment 5

R

Recommendation 2

RF Input 13

RF Outputs 13

S

Shipment 5

Signal Connectors 8

Special Notices 2

Specifications 13

V

Versions 15

Voltage 7

W

Warning 2



Artisan Technology Group is your source for quality new and certified-used/pre-owned equipment

- FAST SHIPPING AND DELIVERY
- TENS OF THOUSANDS OF IN-STOCK ITEMS
- EQUIPMENT DEMOS
- HUNDREDS OF MANUFACTURERS SUPPORTED
- LEASING/MONTHLY RENTALS
- ITAR CERTIFIED SECURE ASSET SOLUTIONS

SERVICE CENTER REPAIRS

Experienced engineers and technicians on staff at our full-service, in-house repair center

*InstraView*SM REMOTE INSPECTION

Remotely inspect equipment before purchasing with our interactive website at www.instraview.com ↗

WE BUY USED EQUIPMENT

Sell your excess, underutilized, and idle used equipment. We also offer credit for buy-backs and trade-ins. www.artisanng.com/WeBuyEquipment ↗

LOOKING FOR MORE INFORMATION?

Visit us on the web at www.artisanng.com ↗ for more information on price quotations, drivers, technical specifications, manuals, and documentation

Contact us: (888) 88-SOURCE | sales@artisanng.com | www.artisanng.com