



Artisan Technology Group is your source for quality new and certified-used/pre-owned equipment

- FAST SHIPPING AND DELIVERY
- TENS OF THOUSANDS OF IN-STOCK ITEMS
- EQUIPMENT DEMOS
- HUNDREDS OF MANUFACTURERS SUPPORTED
- LEASING/MONTHLY RENTALS
- ITAR CERTIFIED SECURE ASSET SOLUTIONS

SERVICE CENTER REPAIRS

Experienced engineers and technicians on staff at our full-service, in-house repair center

*InstraView*SM REMOTE INSPECTION

Remotely inspect equipment before purchasing with our interactive website at www.instraview.com ↗

WE BUY USED EQUIPMENT

Sell your excess, underutilized, and idle used equipment. We also offer credit for buy-backs and trade-ins. www.artisanng.com/WeBuyEquipment ↗

LOOKING FOR MORE INFORMATION?

Visit us on the web at www.artisanng.com ↗ for more information on price quotations, drivers, technical specifications, manuals, and documentation

Contact us: (888) 88-SOURCE | sales@artisanng.com | www.artisanng.com

User Manual

Tektronix

**DS1000 Series
Television Demodulators**

070-9858-01



Copyright © Tektronix, Inc. All rights reserved.

Tektronix products are covered by U.S. and foreign patents, issued and pending. Information in this publication supercedes that in all previously published material. Specifications and price change privileges reserved.

Printed in the U.S.A.

Tektronix, Inc., P.O. Box 1000, Wilsonville, OR 97070-1000

TEKTRONIX and TEK are registered trademarks of Tektronix, Inc.

WARRANTY

Tektronix warrants that the products that it manufactures and sells will be free from defects in materials and workmanship for a period of one (1) year from the date of shipment. If a product proves defective during this warranty period, Tektronix, at its option, either will repair the defective product without charge for parts and labor, or will provide a replacement in exchange for the defective product.

In order to obtain service under this warranty, Customer must notify Tektronix of the defect before the expiration of the warranty period and make suitable arrangements for the performance of service. Customer shall be responsible for packaging and shipping the defective product to the service center designated by Tektronix, with shipping charges prepaid. Tektronix shall pay for the return of the product to Customer if the shipment is to a location within the country in which the Tektronix service center is located. Customer shall be responsible for paying all shipping charges, duties, taxes, and any other charges for products returned to any other locations.

This warranty shall not apply to any defect, failure or damage caused by improper use or improper or inadequate maintenance and care. Tektronix shall not be obligated to furnish service under this warranty a) to repair damage resulting from attempts by personnel other than Tektronix representatives to install, repair or service the product; b) to repair damage resulting from improper use or connection to incompatible equipment; c) to repair any damage or malfunction caused by the use of non-Tektronix supplies; or d) to service a product that has been modified or integrated with other products when the effect of such modification or integration increases the time or difficulty of servicing the product.

THIS WARRANTY IS GIVEN BY TEKTRONIX IN LIEU OF ANY OTHER WARRANTIES, EXPRESS OR IMPLIED. TEKTRONIX AND ITS VENDORS DISCLAIM ANY IMPLIED WARRANTIES OF MERCHANTABILITY OR FITNESS FOR A PARTICULAR PURPOSE. TEKTRONIX' RESPONSIBILITY TO REPAIR OR REPLACE DEFECTIVE PRODUCTS IS THE SOLE AND EXCLUSIVE REMEDY PROVIDED TO THE CUSTOMER FOR BREACH OF THIS WARRANTY. TEKTRONIX AND ITS VENDORS WILL NOT BE LIABLE FOR ANY INDIRECT, SPECIAL, INCIDENTAL, OR CONSEQUENTIAL DAMAGES IRRESPECTIVE OF WHETHER TEKTRONIX OR THE VENDOR HAS ADVANCE NOTICE OF THE POSSIBILITY OF SUCH DAMAGES.



Table of Contents

General Safety Summary	vii
Preface	ix
Contacting Tektronix	x

Getting Started

Product Description	1-1
Physical Dimensions	1-2
Options	1-2
Standard Accessories	1-3
Optional Accessories	1-3
Electrical Installation	1-4
AC Power Source	1-4
Changing the Mains Voltage	1-4
Power On Procedure	1-4
Mechanical Installation	1-6
Custom Installation	1-7
Rackmount Information	1-7
Functional Check	1-8

Operating Basics

Functional Overview	2-1
Front Panel Features	2-1
Rear Panel Connectors	2-3
Operating Procedures	2-4
Applying Power	2-4
Selecting Display Modes	2-5
Selecting a Program	2-8
Adjusting the Current Program	2-9

Reference

Configuring Operation	3-1
Quick Guide	3-2
Program Configuration	3-3
Serial Configuration	3-8

Frequency Response Configuration	3-10
Contrast Adjustment	3-12
User Defined Channel Table	3-13

Appendices

Appendix A: Performance Specifications	A-1
Appendix B: Remote Control	B-1
Serial Port Connection	B-1
Programming Model	B-3
Addresses	B-3
Remote Operation Flag	B-4
Command Types	B-5
Sending and Receiving Data	B-5
Send Address Phase	B-5
Send Data Phase	B-6
Receive Address Phase	B-7
Polling for Status Messages	B-8
Getting a Message	B-9
Command Syntax	B-11
Data Types	B-11
Data Offset	B-12
Remote Command Descriptions	B-13
AFC	B-13
AUD_OUT	B-14
AUD_PREF	B-15
BTSC	B-16
CHANNEL	B-17
DISC	B-18
FREQ	B-19
IDN	B-20
LOG? (Query only)	B-21
MSG	B-21
MSG_C	B-22
PATH	B-23
PRESET	B-24
PWD	B-24
RECPRT	B-25
REPORT? (Query only)	B-26
SETT	B-26
STRAP	B-28

TUNING	B-29
ZCP	B-30
Appendix C: Service	C-1
Packaging for Shipment	C-1
Replacing the Fuse	C-2
Cleaning the Exterior	C-2
Appendix D: Channel Tables	D-1
Appendix E: Factory Default Settings	E-1

Glossary

Index

List of Figures

Figure 1–1: Rear panel connectors	1–5
Figure 1–2: Typical system configuration	1–6
Figure 2–1: DS1000 series front panel	2–1
Figure 2–2: Rear-panel connectors for NTSC and PAL models	2–3
Figure B–1: Pin assignments for the SERIAL connector ..	B–2

List of Tables

Table 1–1: Power cord identification	1–2
Table 3–1: Configure menu hierarchy	3–1
Table 3–2: Frequency response adjustment bands	3–11
Table A–1: Video specifications	A–2
Table A–2: Audio specifications	A–3
Table A–3: Electrical specifications – power requirements	A–4
Table A–4: Environmental characteristics	A–4
Table A–5: Physical characteristics	A–4
Table A–6: Certifications and compliances	A–5
Table A–7: Safety certification and compliance	A–6
Table A–8: Safety standards	A–7
Table B–1: Rear-panel SERIAL port connections	B–2
Table B–2: Special byte codes	B–3
Table B–3: Data types used in remote communication	B–11
Table D–1: CATV HRC channel table	D–2
Table D–2: CATV IRC channel table	D–3
Table D–3: CATV standard channel table	D–5
Table D–4: Standard channel table	D–7
Table D–5: IRC channel table	D–9
Table D–6: HRC channel table	D–10
Table D–7: Broadcast channel table	D–12
Table D–8: UHF Europa channel table	D–13
Table D–9: UHF China channel table	D–14
Table D–10: VHF Europa channel table	D–15

Table D-11: VHF France channel table	D-16
Table D-12: VHF Italy channel table	D-16
Table D-13: VHF Australia channel table	D-16
Table D-14: VHF China channel table	D-17
Table D-15: VHF Ireland channel table	D-17
Table D-16: VHF New Zealand channel table	D-17
Table D-17: VHF South Africa channel table	D-18
Table D-18: VHF OIRT channel table	D-18
Table D-19: VHF CCIR channel table	D-18
Table E-1: Program default settings	E-1
Table E-2: System default settings	E-2

General Safety Summary

Review the following safety precautions to avoid injury and prevent damage to this product or any products connected to it. To avoid potential hazards, use this product only as specified.

Only qualified personnel should perform service procedures.

While using this product, you may need to access other parts of the system. Read the *General Safety Summary* in other system manuals for warnings and cautions related to operating the system.

To Avoid Fire or Personal Injury

Use Proper Power Cord. Use only the power cord specified for this product and certified for the country of use.

Connect and Disconnect Properly. Do not connect or disconnect probes or test leads while they are connected to a voltage source.

Ground the Product. This product is grounded through the grounding conductor of the power cord. To avoid electric shock, the grounding conductor must be connected to earth ground. Before making connections to the input or output terminals of the product, ensure that the product is properly grounded.

Observe All Terminal Ratings. To avoid fire or shock hazard, observe all ratings and markings on the product. Consult the product manual for further ratings information before making connections to the product.

Do Not Operate Without Covers. Do not operate this product with covers or panels removed.

Use Proper Fuse. Use only the fuse type and rating specified for this product.

Avoid Exposed Circuitry. Do not touch exposed connections and components when power is present.

Do Not Operate in Wet/Damp Conditions.

Do Not Operate in an Explosive Atmosphere.

Keep Product Surfaces Clean and Dry.

Provide Proper Ventilation. Refer to the manual's installation instructions for details on installing the product so it has proper ventilation.

Safety Terms and Symbols

Terms in This Manual. These terms may appear in this manual:



WARNING. *Warning statements identify conditions or practices that could result in injury or loss of life.*



CAUTION. *Caution statements identify conditions or practices that could result in damage to this product or other property.*

Terms on the Product. These terms may appear on the product:

DANGER indicates an injury hazard immediately accessible as you read the marking.

WARNING indicates an injury hazard not immediately accessible as you read the marking.

CAUTION indicates a hazard to property including the product.

Symbols on the Product. These symbols may appear on the product:



WARNING
High Voltage



Protective Ground
(Earth) Terminal



CAUTION
Refer to Manual



Double
Insulated



Preface

This is the user manual for the DS1000 Series Television Demodulators. It contains information about the DS1000 Series of products which includes: DS1001 (NTSC), DS1002 (PAL B/G), and DS1003 (PAL I).

Manual Overview

Topics covered in this manual are as follows:

- *Getting Started* includes a product description as well as installation and first-time power-on procedures.
- *Operating Basics* contains a functional overview, describing the front- and rear-panel controls and connectors and a tutorial, guiding the user through basic instrument operation.
- *Reference* contains details on setting up unit presets and descriptions of each preset item and its function.
- *Appendix A* provides instrument specifications, both electrical and mechanical.

Appendix B describes remote control interfaces, techniques, and the command set.

Appendix C describes changing fuses and cleaning the product.

Appendix D contains channel tables.

Appendix E details the factory default settings.

Contacting Tektronix

Product Support	<p>For application-oriented questions about a Tektronix measurement product, call toll free in North America: 1-800-TEK-WIDE (1-800-835-9433 ext. 2400) 6:00 a.m. – 5:00 p.m. Pacific time</p> <p>Or contact us by e-mail: tm_app_supp@tek.com</p> <p>For product support outside of North America, contact your local Tektronix distributor or sales office.</p>
Service Support	<p>Contact your local Tektronix distributor or sales office. Or visit our web site for a listing of worldwide service locations.</p> <p>http://www.tek.com</p>
For other information	<p>In North America: 1-800-TEK-WIDE (1-800-835-9433) An operator will direct your call.</p>
To write us	<p>Tektronix, Inc. P.O. Box 1000 Wilsonville, OR 97070-1000</p>



Getting Started

Getting Started

This section provides the information you need to use the television demodulator for the first time. Refer to the following sections to prepare the instrument for operation:

- *Product Description*
- *Options*
- *Electrical Installation*
- *Mechanical Installation*
- *Functional Check*

Product Description

The television demodulator can demodulate standard television RF signals to baseband video and audio. Different models cover the range of 55.25 to 801.25 MHz for NTSC M/N and 45.25 to 860.25 MHz for PAL B/G, and I. The high performance of the conversion guarantees a measurement-quality signal after demodulation.

Television demodulator	Television system
DS1001	NTSC
DS1002	PAL B/G
DS1003	PAL I

To find the nomenclature and serial number of your instrument, check either of the following places:

- Before you have mounted the television demodulator, look at the identification tag on the bottom panel.
- After you have installed and powered on the television demodulator, push the Display button three times.

By applying an RF signal to the antenna input, the television demodulator provides baseband video and audio outputs and IF output signals.

You can set tuning conditions for stored programs, which are held in non-volatile memory. Tune the signal by channel, frequency, or preset program. Twenty presets can be stored and recalled with different configurations.

Most instrument functions are controllable through the remote serial interface. Connection is through the SERIAL connector (9 pin) on the rear panel. The interface type, RS232C or RS485, is configured through the Serial Config menu. With the RS485 protocol, you can set unique addresses for multiple units and control them all remotely.

Physical Dimensions

The dimensions of the television demodulator are length 1.8 inches (46 mm), width 8.1 inches (206 mm), and depth 17.3 inches (440 mm). In a 19 inch (483 mm) rack, it is a half rack wide by one rack unit high.

Options

You can purchase the television demodulator with several options and accessories. Table 1-1 lists the power cord options.

Table 1-1: Power cord identification

Plug configuration	Normal usage	Option number
	North America 125V/15A Plug NEMA 5-15P	Standard
	Europe 230 V	A1

Table 1–1: Power cord identification (cont.)

Plug configuration	Normal usage	Option number
	United Kingdom 230 V	A2
	Australia 230 V	A3

Standard Accessories

Your television demodulator includes the standard accessories listed below:

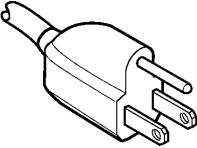
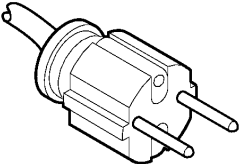
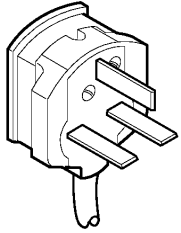
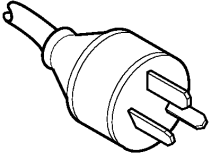
- Standard North American Power Cord (161-0066-00)
- Two, 250 V, 1.6 A (1.6AT) replacement fuses (159-0366-00)
- User Manual (070-9858-XX), this manual

Optional Accessories

You can order the following rackmounting kits from Tektronix:

- TVGF11A adapter mounts a single instrument in a standard 19-inch rack.
- TVGF13 adapter mounts two half-rack width instruments side-by-side in a standard 19-inch rack. Use this adapter to mount DS1000 and VM100 series instruments side by side.
- TVGF14 adapter mounts two half-rack width instruments vertically in a standard 19-inch rack. Use this adapter to mount DS1000 and VM100 series instruments with a 1700 series monitor.

Electrical Installation

Before proceeding with product installation, please read the *Safety Summary* at the front of this manual.

NOTE. *Save the shipping carton and packing materials in case it becomes necessary to ship the television demodulator to a Tektronix Service Center for service or repair. Packaging instructions are on page C-1.*

AC Power Source

The television demodulator operates from an AC source with a line voltage in the range 95 to 240 VAC and with a line frequency of 50 or 60 Hz.

The television demodulator is designed to operate from a single-phase power source having one of its current-carrying conductors at or near earth ground (the neutral conductor). Only the line conductor is fused for over-current protection.

Systems that have both current-carrying conductors live with respect to ground (such as phase-to-phase on multiphase systems) are not recommended as power sources. A protective ground connection by way of the grounding conductor in the power cord is essential for safe operation.

Changing the Mains Voltage

The unit is designed to operate over the specified range (95 to 240 VAC) without the need for adjustment.

Power On Procedure

To power on the television demodulator, connect it to the AC power source. There is no power switch. See Figure 1-1. The power on sequence completes in about 10 seconds.

The television demodulator tests major circuits during power on and displays the following status messages:

ROM test

RAM test

I²C test

System Initialization

When testing completes, the television demodulator displays the current RF setting.

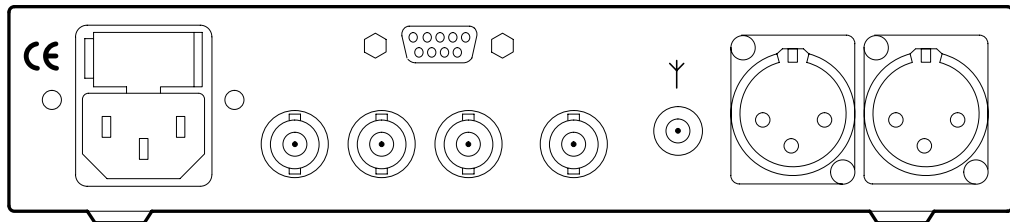

Figure 1-1: Rear panel connectors

Mechanical Installation

The television demodulator requires no assembly. Please read the following sections before installing the television demodulator into a console or equipment rack. Figure 1-2 shows a sample connection in a system including a video monitor and an audio monitor.

NOTE. All qualification testing was performed with the factory-shipped cabinet installed. To guarantee compliance with specifications, operate the instrument only in the original cabinet.

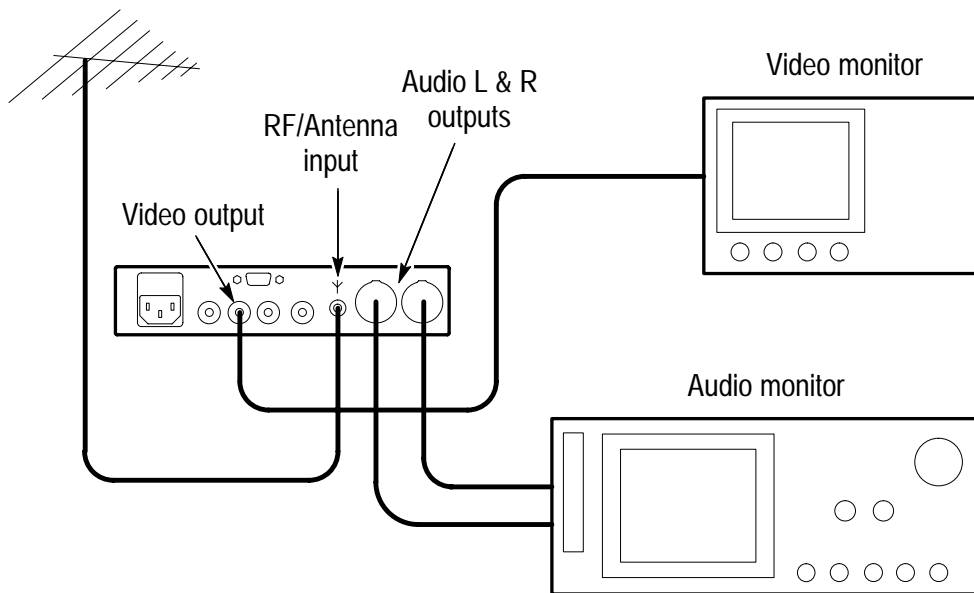

Figure 1-2: Typical system configuration

Custom Installation



CAUTION. To avoid damage to the television demodulator, attach it to a shelf that is strong enough to hold its weight (4.8 lbs/2.2 kg).

For applications that require installation into consoles, the television demodulator can be mounted with the front moulding flush or protruding from the console. Always allow approximately 3 inches (7.6 cm) of rear panel clearance for cable and power cord connections.

Rackmount Information

The television demodulator is one half-rack wide and one rack unit high. It requires approximately 3 inches (7.6 cm) of rear panel clearance for the power cord and cable connections and 20 inches (50.8 cm) in front of the rack for installation and removal.

You can order the following rackmounting kits from Tektronix:

- TVGF11A adapter mounts a single instrument in a standard 19-inch rack.
- TVGF13 adapter mounts two half-rack width instruments side-by-side in a standard 19-inch rack. Use this adapter to mount DS1000 and VM100 series instruments side by side.
- TVGF14 adapter mounts two half-rack width instruments vertically in a standard 19-inch rack. Use this adapter to mount DS1000 and VM100 series instruments with a 1700 series monitor.

Functional Check

To check that the television demodulator is operating correctly, perform the following procedures:

1. Connect the television demodulator to power and wait a few seconds for the power-on tests and initialization. If these tests pass, the display will show the current frequency/channel setting.
2. Apply an RF signal feed from an appropriate television standard for your model of television demodulator to the RF input. Use a 75 Ω coaxial cable. The RF source should match the current frequency/channel setting. If not, refer to the *Operating Basics* section for information on selecting a new frequency/channel.
3. Connect the video output (VIDEO O/P) either to a picture monitor, waveform monitor, or other monitoring equipment. Ensure that this connection is terminated in 75 Ω .
4. Check for a valid video display and, if possible, a nominal 1 Vpp signal level.
5. Connect the audio outputs (AUDIO OUT R and AUDIO OUT L) to a suitable audio monitoring device. For example, use the Lindos LA102 Audio Measuring Set. Check for a nominal 0 dBm level.
6. Connect the IF output (45.75 IF on the DS1001 model or 38.9 MHz on the DS1002 and DS1003 models) to a 100 MHz oscilloscope terminated in 75 Ω .
7. Check for a modulated RF signal at 45.75 MHz.
8. Connect the 4.5 IF output (DS1001 model only) to a 100 MHz oscilloscope terminated in 75 Ω .
9. Check for a nominal 700 mVpp (+48 dBmV) signal.

This concludes the functional check. If your television demodulator failed any check in this procedure, review your connections, terminations, and instrument settings. A continued failure may indicate the need for repair. Contact your service person or a Tektronix, Inc field office for assistance.



Operating Basics

Operating Basics

The DS1000 Series Television Demodulators are typically used as part of a system that includes video and audio measurement equipment, such as the Tektronix VM100 Series Automated Measurement Set. Typical equipment connections are described in the *Functional Check* procedure on page 1–8 and are shown in Figure 1–2 on page 1–6.

The television demodulator configuration system allows the store and recall of system settings through the use of programs (presets). All program settings are saved in the television demodulator non-volatile memory when the unit is turned off.

The following procedures use factory settings for the illustrations; your display will vary if you have changed the settings.

Functional Overview

This section describes the front-panel and rear-panel features and connectors.

Front Panel Features

This section describes the front panel controls, which are illustrated in Figure 2–1. All models have the same display and controls.

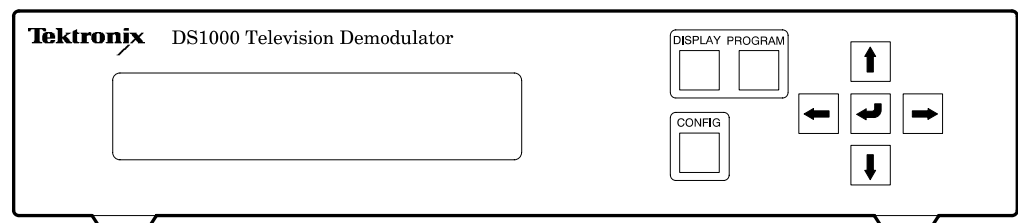

Figure 2–1: DS1000 series front panel

- **Front Panel Display.** The 2 line by 20 character liquid crystal display (LCD) is used to present unit configuration and status information.

The LCD uses “supertwist” technology allowing a wide viewing angle.

The LCD is illuminated with an LED back light, which enables its use in areas with low light levels.

The display contrast is adjustable in the Configure menu, as described on page 3–12 in the *Reference* section.

- **DISPLAY button.** Use the display button to step through the several display modes. Each press of the button steps to the next display mode. When the last display mode is reached, the next press of the display button returns to the first display mode.
- **PROGRAM button.** Use the program button to enter the program selection mode.
- **CONFIG button.** Use the configuration button to modify unit settings.
- **UP and DOWN buttons (↑ and ↓).** Use the up and down buttons to scroll through the program set-up and program configuration items. When the unit status display is active, the up and down buttons can be used to temporarily change the current channel number.
- **LEFT and RIGHT buttons (← and →).** Use the left and right buttons to make changes to program configuration items. When the unit status display is active, the left and right buttons can be used to temporarily change the current frequency.
- **ENTER button (↵).** Use the enter button to enter the required configuration mode and to accept configuration changes.

Rear Panel Connectors

This section describes the rear panel connectors, which are illustrated in Figure 2–2.

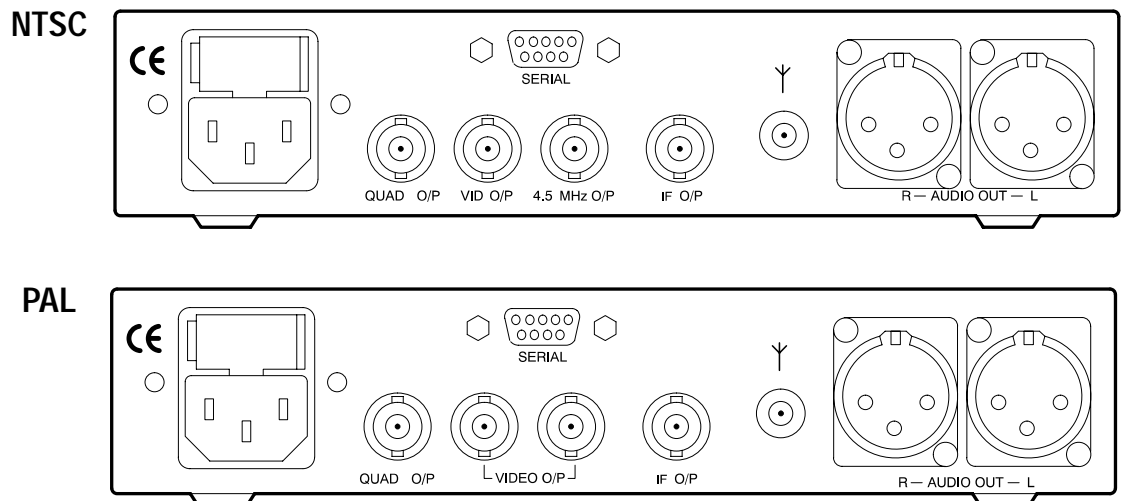

Figure 2–2: Rear-panel connectors for NTSC and PAL models

- **Power Input Connector.** Accepts the AC power cord assembly that is shipped with the product.
- **Fuse Holder.** Provides a safety fuse for the AC mains input (95–240 V operation). The fuse holder is located just above the AC power connector. Refer to *Appendix C* for fuse replacement instructions.
- **Serial Connector.** Provides a bidirectional serial connection for remote control by a PC. The connector is a 9-pin, subminiature D-type. Serial communication using this connector complies with RS232 and RS485 standards. For instructions on selecting the RS232 or the RS485 interface, refer to *Serial Configuration* on page 3–8. For remote control commands and techniques, refer to *Appendix B*.
- **QUAD O/P.** Provides a quadrature video output with nominal 75 Ω impedance.

- VIDEO O/P. Provides a standard 1 volt video output with nominal 75 Ω impedance. The NTSC model has one output and the PAL models have two identical VIDEO O/P outputs. See Figure 2–2.
- 4.5 MHz O/P. (NTSC only) Provides a buffered 4.5 MHz audio subcarrier output with nominal 75 Ω impedance.
- IF O/P. Provides a buffered IF output of the full video vestigial side band with all sound carriers (NTSC: 45.75 MHz, PAL: 38.9 MHz). The nominal impedance is 75 Ω . This output is available for re-modulation or monitoring (75 Ω terminated).
- RF Input (Υ). Provides RF signal input with a sensitivity of -20 to $+30$ dBmV and a nominal 75 Ω impedance.
- AUDIO OUT (L). Provides a BTSC stereo left channel or mono channel output for NTSC systems. For PAL systems, it provides a NICAM/FM audio output, left channel or language 1 dual mode.
- AUDIO OUT (R). Provides a BTSC stereo right channel or second audio program (SAP) output for NTSC systems. For PAL systems, it provides a NICAM/FM audio output, right channel or language 2 dual mode.

Operating Procedures

This section describes how to correctly apply power to the television demodulator and how to operate the instrument.

Applying Power

1. Apply an appropriate mains power source to the television demodulator through the supplied power cord. There is no power switch.
2. The front panel LCD briefly displays the starting self-test message before starting the self-tests. Each of the self-tests displays a different test message. If any of the tests fail, a test failure message appears and the unit waits for you to press a button before it continues with the remaining tests.

Once the self-tests complete, the unit initializes itself, which takes about 1 second to perform if the internal non-volatile memory is valid.

If the memory has been corrupted or damaged, then the television demodulator will attempt to load factory default settings. This process takes 5 to 10 seconds. When the initialization sequence completes, the unit displays the current channel/frequency selection along with the RF signal strength.

Selecting Display Modes

To access the display modes for the television demodulator, press the DISPLAY button on the front panel. Each press of the display button accesses the next display mode. When you reach the last display mode, the next press of the display button returns the display to the first display mode. The following list describes the display modes in their order of appearance:

1. System Status.

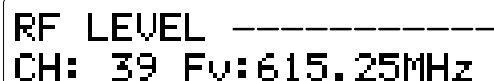

```
RF LEVEL -----  
CH: 39 Fv:615.25MHz
```

After power on sequence completes, the display shows the current channel and frequency selection and the RF signal strength for the channel and frequency.

The channel number is taken from the frequency table you select. It may be either numeric or alphanumeric depending on its definition in the frequency table.

If the frequency does not correspond to a channel frequency in the current frequency table, then the channel number is replaced by asterisks.

The RF signal strength is displayed in the form of a bar graph and represents the signal strength for the current channel frequency. A weak signal (RF amplitude $< 100 \mu\text{V}$) is represented by 10 dashes ‘—’ on the bar graph. As the signal strength increases in amplitude,

the dashes are replaced by blocks '■' from the left, until all dashes have been replaced (RF amplitude > 1 mV).

2. Audio Output Status.

```
AUDIO OUTPUT STATUS
AL:STEREO AR:STEREO
```

The audio output display shows the current status of the audio signals on the XLR connectors located on the rear panel.

3. Program Set-up.

```
PROGRAM SET UP: 01
CH: 39 Fv:615.25MHz↓
```

The program set-up display allows you to view the configuration of the current program (preset). The top line shows the active program number and the bottom lines shows the program items. Use the up and down buttons (↑ and ↓) to view the entire configuration by scrolling through the various program items. Refer to page 3-3 for a description of each item in the Program set up.

To change a Program, select the Program number here, then press the CONFIG button. Refer to *Program Configuration* on page 3-3 for further instructions.

4. NICAM Error Count (PAL systems only).

```
NICAM ERROR COUNT
Av: 0 Pk: 0 Ph: 0
```

The error count gives the number of NICAM errors per 128 ms period. Three versions of the error count are displayed:

Av – Average error count shows the average number of errors over the last ten readings.

Pk – Peak error count shows peak errors and delays while the error count is less than the displayed peak error count.

Ph – Peak hold error count shows the maximum error count. It is updated if the latest error count exceeds the current peak hold error count.

All three error counts can be cleared by pressing the enter (↵) button when in the Nicam error count display mode.

5. Product title.

```
PRODUCT: DS1001 (MN)  
SERIAL No.: 00001234
```

The product title display shows the product number, transmission standard and unit serial number.

6. Firmware revision.

```
FIRMWARE: FW0507  
REVISION: 01
```

The firmware revision display shows the firmware number and the revision number of firmware in the television demodulator. You will need this revision number when reporting problems in operation to Tektronix representatives.

7. Temperature status.

```
UNIT TEMPERATURE  
STATUS: NORMAL
```

The temperature status display shows when the internal SAW filter reaches its normal operating temperature. The status is one of the following readouts:

- **LOW.** The television demodulator has not reached its normal operating temperature.
- **NORMAL.** The television demodulator has reached its normal operating temperature.
- **HIGH.** The television demodulator has exceeded its recommended operating temperature range.

Selecting a Program

The television demodulator can store and recall 20 different programs (presets) from non-volatile memory. Only one of the programs is active at a time. Use the PROGRAM button to select a program.

Pressing the PROGRAM button brings up the program selection display. The first line displays the current active program number and the second line displays the program channel and frequency.

```
PROGRAM SELECT: 04 ↑  
CH: 39 Fv:615.25MHz↓
```

Use the up and down buttons (↑ and ↓) to select from the 20 stored programs.

As each program number appears, its program configuration becomes active. When you reach the required program number, pressing the display button exits the program selection mode. The selected

program becomes the active program and will be recalled the next time you power on the unit.

Adjusting the Current Program

You can temporarily adjust the channel number and frequency while in the system status display. Use the up and down buttons (↑ and ↓) to change the channel and the left and right buttons to change the frequency. The changes you make are temporary and will be lost when you select another display mode or remove the AC power.



Reference

Reference

This section describes how to configure the television demodulator to fit your application.

Configuring Operation

The television demodulator has many configurable parameters which it stores in non-volatile memory. Use the Configuration menu to select items. Table 3–1 lists the configurable items in the sequence that they appear.

Changes to program items immediately change the operation of the television demodulator. This active control allows you to see the affects of a change without exiting the program configuration mode. If selected changes do not give the desired result, you can discard the changes by exiting the configuration mode using the ‘NO’ save option.

Refer to *Appendix E* for a list of factory default settings for all configurable items.

Table 3–1: Configure menu hierarchy

	Configure menu	Selections	Range
1	Program	Frequency Table	UHF, VHF, user defined
		Channel	Various
		Frequency	NTSC: 55.25 to 801.25 MHz PAL: 45.25 to 860.25 MHz
		ZCP Status	On, Off
		ZCP Line Number	NTSC: 10-20 (F1 & F2) PAL: 6-16, 319-329
		ZCP Position	0 to 4

Table 3-1: Configure menu hierarchy (cont.)

	Configure menu	Selections	Range
		Audio Preference	NTSC: BTSC PAL: NICAM, FM
		Audio Input Select	NTSC: Mono, Mono-SAP, Stereo, SAP PAL: Mono1, Mono2, Mono1-Mono2, Stereo
		AFC Status	On, Off
		Sound Trap	On, Off
		Stereo Noise	NTSC: 1-16
		SAP Noise	NTSC: 1-16
2	Frequency Response	Manual Frequency Response Adjust	-10 to +10
3	Contrast Adjust	Display Contrast Adjust	Dark to Max brightness
4	User Channel Table	Channel (1-50)	NTSC: 55.25 to 801.25 MHz PAL: 45.25 to 860.25 MHz
5	Serial Set-up	Serial Mode	RS232, RS485
		Unit Address	32 to 63
		RTS/CTS	Disabled, Enabled
		RS485 Termination	Unterminated, Terminated

Quick Guide

To configure the television demodulator, follow these procedures:

1. Press the front panel CONFIG button to access the Configuration menu.
2. Use the up and down buttons (↑ and ↓) to select a configuration mode.
3. Press the enter button (↵) to enter the selected configuration mode.

4. Use the up and down buttons (\uparrow and \downarrow) to select a configuration item. Use the left and right buttons (\leftarrow and \rightarrow) to change the selected configuration item.
5. Press the CONFIG button after making the desired changes. If you have made no changes, then the Configuration menu returns. If you have made changes, then you are asked if you want to save the changes. Use the left and right buttons (\leftarrow and \rightarrow) to select either yes or no, then press the enter button (\downarrow).
6. To exit the configuration mode, press the DISPLAY button.

Program Configuration

The Program selection in the Configure menu allows you to modify a Program. Before entering the Configure menu, you must select the Program number you wish to modify.



To modify a Program, press the Program button and use the up and down buttons (\uparrow and \downarrow) to choose the program number you wish to modify. Then press the CONFIG button to access the Configuration menu. The top level selection is Program. Press the enter button (\downarrow) to enter the Program Config menu. Use the up and down buttons (\uparrow and \downarrow) to choose and change any of the following selections:

1. Frequency tables.



The television demodulator contains a wide variety of frequency tables that list the channel assignments used in many countries. The channel assignments cover the standard television frequency spectrum.

You can select a frequency table using the FT item. Only one frequency table can be active for an individual program, but different programs can use different frequency tables. *Appendix D* includes a complete list of the frequency tables.

2. Channel.



Use the channel item (CH) to select a channel from the chosen frequency table. The channel frequency appears in brackets after the channel number. This channel selection and the following frequency selection interact. Changing either one will change the other.

3. Frequencies.



If the required frequency is not contained in any frequency table, you can manually set the frequency using the frequency item (Fv). The frequency range is 45.25 MHz to 860.25 MHz in 0.25 MHz steps.

If the selected frequency corresponds to a standard channel, then that channel number appears in parentheses. Otherwise, asterisks appear in place of the channel number. This frequency selection

and the previous channel selection interact. Changing either one will change the other.

4. ZCP.

The zero carrier pulse (ZCP) is a special feature of the television demodulator. You configure the ZCP feature using the ZCP status, ZCP line, and ZCP position items.

The ZCP status item determines whether the ZCP signal is on or off.



The ZCP line setting determines on which video line the ZCP is active. For PAL systems the line number range is 6 to 16 and 319 – 329. For NTSC systems the line number range is 10 to 20 (F1) and 10 to 20 (F2).



The ZCP position item determines the start position of the ZCP on the chosen video line. The five position choices are 0 to 4.



5. Audio Preference.

```

CONFIG PROGRAM: 01 ↑
AUDIO PREF: BTSC ↓
    
```

For NTSC systems, the audio preference is set to BTSC with no other options.

For PAL systems, the audio preference item determines which audio system has primary control. The choices are NICAM and FM. If the primary choice signal is not present, then the secondary choice takes control.

6. Audio Input Selection.

```

CONFIG PROGRAM: 01 ↑
AL:STEREO AR:STEREO↓
    
```



The audio input selection item allows control of the audio outputs on the rear panel. For PAL systems, the available choices are MONO1, MONO2, DUAL MONO and STEREO. For NTSC systems, the available choices are MONO, MONO/SAP, STEREO and SAP.

7. AFC.

```

CONFIG PROGRAM: 01 ↑
AFC: OFF ↓
    
```



OFF ON

The AFC selection, when enabled, sets the tuning system of the television demodulator to locate and lock to a frequency that drifts

or to a frequency that is between the standard 0.25MHz frequency steps. The AFC function is not normally required for broadcast signals and should be used with caution because of its limited range of ± 1 MHz about the video carrier frequency.

The options for the AFC item are either on or off.

8. Sound Trap.

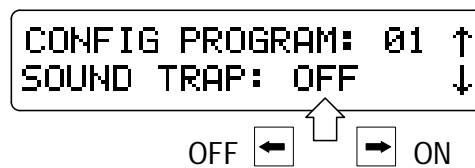

The sound trap status item, when enabled, adds extra filtering to remove any sound element from the video signal. The options for the sound trap item are either on or off.

9. BTSC Stereo/SAP Noise Thresholds.



The BTSC Stereo and SAP noise threshold items are only present on NTSC systems and are used to switch stereo and SAP outputs off when the thresholds are reached. The range for both items is 1 to 16.



Serial Configuration

The Serial Set-up selection in the Configure menu, allows you to set the communications parameters of the serial port on the rear-panel.

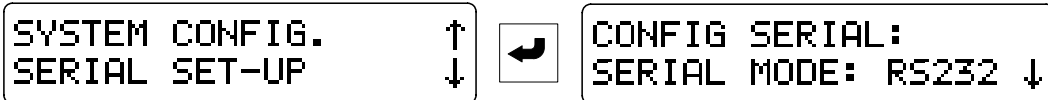

To modify the serial port setup, press the CONFIG button to access the Configure menu. Use the up and down buttons (↑ and ↓) to select SERIAL SET-UP. Press the enter button (↵) to enter the Config Serial menu. Use the up and down buttons (↑ and ↓) to choose and change any of the following selections:

1. Serial Mode.



Sets the mode of the serial port to either RS232 or RS485. Refer to *Serial Port Connection* on page B-1 for connection information.

2. Unit Address.

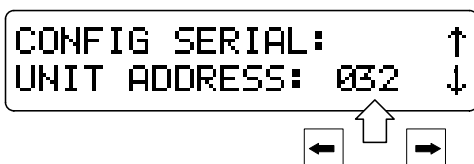

Sets the RS485 serial mode address. A controlling terminal or PC uses this address to identify and control a particular instrument.

The RS485 communications protocol allows connection of multiple units to one host. Each device connected to the host must have a unique address. The range for the unit address is 32 to 63.

3. RS232 RTS/CTS status.

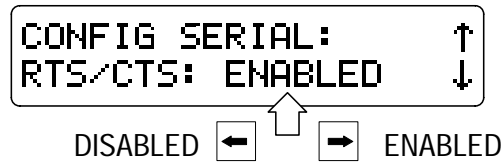

Enables or disables hardware handshaking on the serial port when in the RS232 serial mode.

4. RS485 termination.

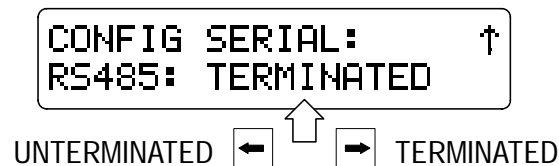

Enables or disables termination at the television demodulator in the RS485 serial mode. Enable termination when the television demodulator is the last device in a multi-drop system. Select unterminated when it is not the last device.

Frequency Response Configuration

In the television demodulator system there are two levels of frequency response adjustment. The first is factory set and cannot be adjusted from the front panel. The second is the manual frequency response item which allows minor adjustments to the frequency response.

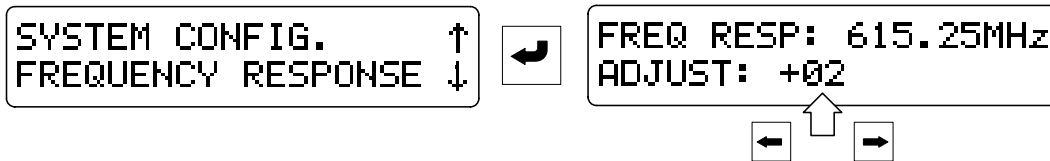

Use caution when changing the manual frequency response and do so only when connected to equipment that can measure the changes to frequency response.

The changes to frequency response affect only the current active frequency, which is shown on the top line of the frequency response configuration display. You can adjust several frequencies which are stored in the television demodulator non-volatile memory.

Due to memory limitations within the television demodulator, it is impractical to store frequency response adjustments for every possible frequency, so the adjustments are possible only for the range of frequencies listed in Table 3-2.

Table 3–2: Frequency response adjustment bands

Low band	Mid band	High band
40.00 – 47.75 MHz	170.00 – 179.75 MHz	454.25 – 469.75 MHz
48.00 – 55.75 MHz	180.00 – 189.75 MHz	470.00 – 489.75 MHz
56.00 – 63.75 MHz	190.00 – 199.75 MHz	490.00 – 509.75 MHz
64.00 – 71.75 MHz	200.00 – 209.75 MHz	510.00 – 529.75 MHz
72.00 – 79.75 MHz	210.00 – 219.75 MHz	530.00 – 549.75 MHz
80.00 – 87.75 MHz	220.00 – 229.75 MHz	550.00 – 569.75 MHz
88.00 – 95.75 MHz	230.00 – 239.75 MHz	570.00 – 589.75 MHz
96.00 – 103.75 MHz	240.00 – 249.75 MHz	590.00 – 609.75 MHz
104.00 – 111.75 MHz	250.00 – 259.75 MHz	610.00 – 629.75 MHz
112.00 – 119.75 MHz	260.00 – 269.75 MHz	630.00 – 649.75 MHz
120.00 – 127.75 MHz	270.00 – 279.75 MHz	650.00 – 669.75 MHz
128.00 – 135.75 MHz	280.00 – 289.75 MHz	670.00 – 689.75 MHz
136.00 – 143.75 MHz	290.00 – 299.75 MHz	690.00 – 709.75 MHz
144.00 – 151.75 MHz	300.00 – 309.75 MHz	710.00 – 729.75 MHz
152.00 – 159.75 MHz	310.00 – 319.75 MHz	730.00 – 749.75 MHz
160.00 – 162.75 MHz	320.00 – 329.75 MHz	750.00 – 769.75 MHz
163.00 – 167.75 MHz	330.00 – 339.75 MHz	770.00 – 789.75 MHz
168.00 – 169.75 MHz	340.00 – 349.75 MHz	790.00 – 809.75 MHz
	350.00 – 359.75 MHz	810.00 – 829.75 MHz
	360.00 – 369.75 MHz	830.00 – 849.75 MHz
	370.00 – 379.75 MHz	850.00 – 860.25 MHz
	380.00 – 389.75 MHz	
	390.00 – 399.75 MHz	
	400.00 – 409.75 MHz	

Table 3-2: Frequency response adjustment bands (cont.)

Low band	Mid band	High band
	410.00 – 419.75 MHz	
	420.00 – 429.75 MHz	
	430.00 – 439.75 MHz	
	440.00 – 454.00 MHz	

Contrast Adjustment

The Contrast Adjust selection in the Configure menu, allows you to set the contrast of the front-panel LCD display.

To modify the contrast, press the CONFIG button to access the Configure menu. Use the up and down buttons (↑ and ↓) to select Contrast Adjust. Press the enter button (↵) to enter the Contrast Adjustment menu.

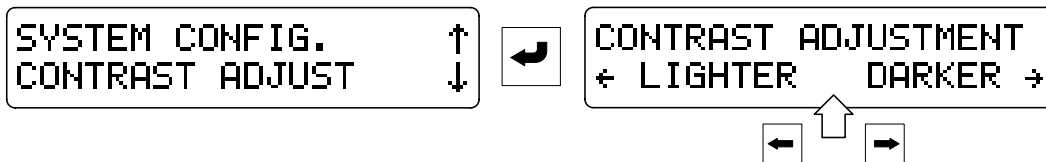

Use the left and right buttons (← and →) to set the contrast lower or higher as appropriate for the ambient light level. Press the enter button (↵) when you have finished.

User Defined Channel Table

The User Channel Table selection in the Configure menu, allows you to store several custom channel and frequency combinations in the User Channel Table.

To create or modify the User Channel Table, press the CONFIG button to access the Configure menu. Use the up and down buttons (↑ and ↓) to select the User Channel Table. Press the enter button (↵) to enter the User Channel Table menu.

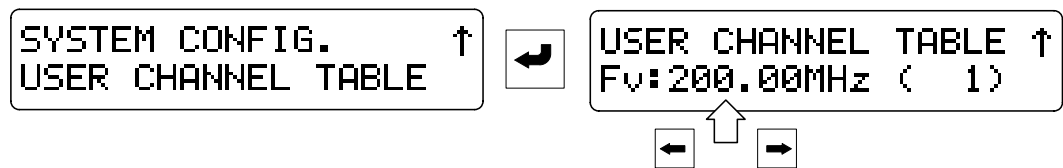

The television demodulator can store several custom channels and frequencies. You can select from channels 1 to 50 using the up and down arrow keys. Use the left and right arrow keys to set the new frequency for the channel. The channel frequency is saved when you either press the Config button or select another channel.

You select the User Defined channel table as you do other frequency and channel tables. Refer to *Program Configuration* on page 3–3 for instructions on selecting a frequency table.



Appendices

Appendix A: Performance Specifications

The instrument specifications listed in this section are either performance requirements or reference information.

Performance requirements are valid over an ambient temperature range of 5°C to 35°C, unless otherwise noted. Ensure that test equipment used to verify performance requirements is calibrated and working within its specified limits.

Reference information, marked RI, amplifies a performance requirement or provides useful information on other operating parameters.

This section contains the following specifications:

- Table A–1 Video specifications
- Table A–2 Audio specifications
- Table A–3 Electrical specifications – power requirements
- Table A–4 Environmental characteristics
- Table A–5 Physical characteristics
- Table A–6 Certifications and compliances
- Table A–7 Safety certification compliance
- Table A–8 Safety standards

Table A-1: Video specifications

Category	Product	Description
RF Tuning Range	DS1001 DS1002/3	55.25 – 801.25 MHz 48.25 – 860.25 MHz (under range to 45.25 MHz)
IF Frequency		
Visual	DS1001 DS1002/3	45.75 MHz 38.9 MHz
Aural	DS1001 DS1002 DS1003	41.25 MHz 33.40 MHz, 33.16 MHz, 33.05 MHz (NICAM) 32.90 MHz, 32.35 MHz (NICAM)
IF Output	All	+51 dBmV/+111 dB μ V (typical), BNC
RF Sensitivity ¹	All	0 to +30 dBmV +60 to +90 dB μ V
Return Loss	All	> 6 dB
Input Impedance	All	75 Ω , female F type connector
Frequency stability	All	\pm 50 kHz
Video signal to noise	DS1001 DS1002/3	> 50 dB (NTC7-weighted) > 50 dB (unified-weighted)
Video outputs	DS1001 DS1002/3	One BNC connector Two BNC connectors
Quadrature output	All	1 Vpp, 90° phase of video signal on BNC connector
4.5 MHz Inter-carrier output	DS1001 DS1002/3	One BNC connector None
Differential Gain	All	< 1.5%
Differential Phase	All	\pm 1.5°
Chroma/Luma Delay	All	< 40 ns

¹ Video signal to noise tested at +19 dBmV/+79 dB μ V.

Table A-1: Video specifications (cont.)

Category	Product	Description
Frequency response	DS1001	± 0.7 dB, 100 kHz to 3.58 MHz (18 °C to 26 °C) ± 1.0 dB, 100 kHz to 3.58 MHz (5 °C to 35 °C) ± 2 dB, 3.58 MHz to 4.1 MHz (typical)
	DS1002/3	± 0.7 dB, 100 kHz to 4.43 MHz (18 °C to 26 °C) ± 1.0 dB, 100 kHz to 4.43 MHz (5 °C to 35 °C) ± 2 dB, 4.43 MHz to 5.0 MHz (typical)
Group Delay (Sound trap off)	DS1001	± 50 ns, 100 kHz to 3.58 MHz (Referenced to system M/N)
	DS1002	± 60 ns, 100 kHz to 4.43 MHz (Referenced to system B/G General)
	DS1003	± 60 ns, 100 kHz to 4.43 MHz (Referenced to system I Flat)
Luminance Bar Amp	All	< 2% typical
Luminance Bar Tilt	All	< 3% typical
2T K Factor	All	< 2.5% typical
Line Time Distortion	All	< 3% typical

Table A-2: Audio specifications

Category	Product	Description
Audio Outputs	DS1001	2 XLR configurable (left/right, mono/SAP, mono/mono)
	DS1002/3	2 XLR configurable (auto switching FM or NICAM, auto switching for mono, dual sound, and stereo)
Frequency Response	All	± 0.5 dB, 50 Hz to 12 kHz typical
Total Harmonic Distortion ¹	All	< 1% at 1 kHz
Level	All	0 dBm across 600 Ω

¹ Audio THD tested with a blackburst video signal.

Table A-3: Electrical specifications – power requirements

Category	Description
Line Voltage Ranges	95 to 240 VAC \pm 10%
Power Consumption	30 VA Maximum
Line Frequency	50/60 Hz
Fuse	1.6AT, 250 V (20 mm ceramic)

Table A-4: Environmental characteristics

Category	Description
Operating Temperature	5° C to 35° C
Storing Temperature	-20° C to 75° C
Operating Altitude	6500 ft maximum (2,000 m)
Non-operating Altitude	50,000 ft maximum (15,000 m)
Relative Humidity (maximum operating)	80% for temperatures up to 31° C, decreasing linearly to 50% at 40° C

Table A-5: Physical characteristics

Category	Description
Dimensions	Height: 1.8 in (46 mm) Width: 8.1 in (206 mm) Depth: 17.3 in (440 mm)
Weight	Net Weight: 4.8 lbs (2.2 kg)

Table A-6: Certifications and compliances

Category	Description
EC Declaration of Conformity – EMC	<p>Meets intent of Directive 89/336/EEC for Electromagnetic Compatibility. Compliance was demonstrated to the following specifications as listed in the Official Journal of the European Communities:</p> <p>EN 50081-1 Emissions:²</p> <p>EN 55022 Class B Radiated and Conducted Emissions</p> <p>EN 60555-2 AC Power Line Harmonic Emissions</p> <p>EN 50082-1 Immunity:²</p> <p>IEC 801-2 Electrostatic Discharge Immunity</p> <p>IEC 801-3 RF Electromagnetic Field Immunity</p> <p>IEC 801-4 Electrical Fast Transient/Burst Immunity</p> <p>IEC 801-5 Power Line Surge Immunity</p> <p>² High-quality shielded cables must be used to ensure compliance.</p>
Australia/New Zealand Declaration of Conformity – EMC	<p>Complies with EMC provision of Radiocommunications Act per the following standard(s):</p> <p>AN/NZS 2064.1/2 Industrial, Scientific, and Medical Equipment: 1992</p>
FCC Compliance	<p>Emissions comply with FCC Code of Federal Regulations 47, Part 15, Subpart B, Class A Limits³</p> <p>³ High-quality shielded cables must be used to ensure compliance.</p>
EC Declaration of Conformity – Low Voltage	<p>Compliance was demonstrated to the following specification as listed in the Official Journal of the European Communities:</p> <p>Low Voltage Directive 73/23/EEC, Amended by 93/68/EEC</p> <p>EN 61010-1:1993 Safety requirements for electrical equipment for measurement, control, and laboratory use</p>
Approvals	<p>ANSI/ISA S82.01 – Safety standard for electrical and electronic test, measuring, controlling, and related equipment, 1994</p>

Table A-6: Certifications and compliances (cont.)

Category	Description
	<p>UL3111-1 – Standard for electrical measuring and test equipment</p> <p>CAN/CSA C22.2 No. 1010.1 – Safety requirements for electrical equipment for measurement, control and laboratory use</p>
Installation Category Descriptions	<p>Terminals on this product may have different installation category designations. The installation categories are:</p> <p>CAT III Distribution-level mains (usually permanently connected). Equipment at this level is typically in a fixed industrial location</p> <p>CAT II Local-level mains (wall sockets). Equipment at this level includes appliances, portable tools, and similar products. Equipment is usually cord-connected</p> <p>CAT I Secondary (signal level) or battery operated circuits of electronic equipment</p>

Table A-7: Safety certification and compliance

Category	Description
Temperature (operating)	+5° C to +40° C
Altitude (maximum operating)	6500 feet (2000 meters)
Relative Humidity (maximum operating)	80% for temperatures up to 31° C, decreasing linearly to 50% at 40° C
Equipment Type	Test and Measuring
Safety Class	Class I (as defined in IEC 1010-1, Annex H) – grounded product
Installation Category	Installation category II (as defined in IEC 1010-1, Annex J)
Pollution Degree	Pollution Degree 2 (as defined in IEC 1010-1) Note: Rated for indoor use only.

Table A-8: Safety standards

Category	Description
U.S. Nationally Recognized Testing Laboratory Listing	ANSI/ISA S82.01 – Safety Standard for Electrical and Electronic Test, Measuring, Controlling, and Related Equipment, 1994 UL3111-1 - Standard for Electrical Measuring and Test Equipment
Canadian Certification	CAN/CSA C22.2 No. 1010.1 - Safety Requirements for Electrical Equipment for Measurement, Control, and Laboratory Use.
European Union Compliance	Low Voltage Directive 73/23/EEC, Amended by 93/68/EEC EN61010-1 - Safety Requirements for Electrical Equipment for Measurement, Control, and Laboratory Use.
Additional Compliance	IEC1010-1 - Safety Requirements for Electrical Equipment for Measurement, Control, and Laboratory Use.

Appendix B: Remote Control

This appendix describes how to remotely control the television demodulator. This appendix provides the following information:

- Serial port connection
- Programming model
- Command syntax descriptions
- Alphabetical list of commands

Serial Port Connection



CAUTION. *Connecting or disconnecting cables while the television demodulator is powered on can result in damage to its input circuits.*

The rear panel SERIAL connector allows remote control of the television demodulator using a PC controller. The connector is a 9-pin, subminiature D-type with female contacts. Table B-1 and Figure B-1 give the pin configuration for the SERIAL connector.

The SERIAL connector provides a configurable serial communications port. You can configure the serial port as either RS232 or RS485 using the Serial Configuration menu. Refer to page 3-8.

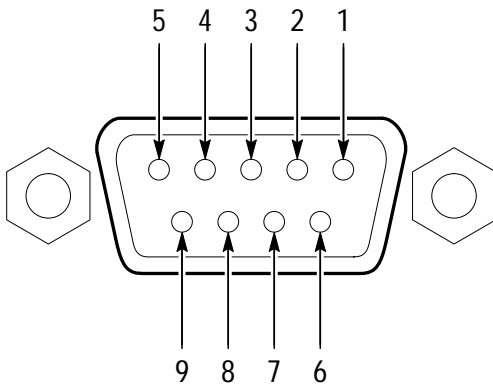

Figure B-1: Pin assignments for the SERIAL connector

Table B-1: Rear-panel SERIAL port connections

Pin	Function	Pin	Function
1	RS485 B	6	Not Used
2	RS232 TxD	7	RS232 CTS
3	RS232 RxD	8	RS232 RTS
4	Not Used	9	RS485 A
5	Signal Ground		

Before initiating remote control of the television demodulator, set the PC serial port as follows:

PC Serial Port Settings	
Speed	9600 bps
Protocol	1 start bit, 8 data bits, no parity, 1 stop bit
Interface	RS485 or RS232 (match the television demodulator setting)
Handshaking	RS232 only, use RTS/CTS hardware handshaking (match the television demodulator setting)

Programming Model

The television demodulator uses the BCP Simplified Communication Link protocol (SCL). With the SCL Protocol, you program a PC to send and receive data using standard I/O functions found in most programming languages, such as C, PASCAL, and BASIC.

The SCL protocol supports asynchronous binary communication, not text or ASCII based. Communication is based on 8-bit bytes ranging from 0 to 255. Table B–2 lists special byte codes used to coordinate data transfers between the PC and the television demodulator. For information on how to use these special byte codes, refer to *Sending and Receiving Data* on page B–5.

Table B–2: Special byte codes

Code mnemonic	ASCII	Description	Control characters
STX	02 hex	Start of data	^B
ETX	03 hex	End of data	^C
ENQ	05 hex	Enquiry	^E
DLE	10 hex	Data link escape	^P
ACKO	11 hex	Device is ready	^Q
WACK	3B hex	Device is not ready	;
Ad	0F hex	Device address	^O
Ar	*	User-defined remote address	
Ars	Ar x 2	Send remote address	
Arr	Ar x 2 + 1	Receive remote address	

* You assign the remote address. For more information, refer to *Addresses* on page B–3.

Addresses

The television demodulator has four addresses that are necessary for communication using the SCL protocol. Table B–2 lists the four addresses: Ad, Ar, Ars, and Arr. For information on using these

addresses, refer to page B-5. The addresses perform the following functions:

- Device address (Ad) is set to 0F hex in all television demodulators. The PC uses the device address to initiate communication with a television demodulator.
- Remote address (Ar) is unique for each television demodulator. You set this unique address as a decimal number. To set the address, use the SERIAL SET-UP item in the configuration menu. The remote address is the base address used to determine the Ars and Arr addresses.
- Send remote address (Ars) is used to send data to the television demodulator. Calculate Ars using the following equation:

$$Ars = Ar \times 2$$

- Receive remote address (Arr) is used to receive data from the television demodulator. Calculate Arr using the following equation:

$$Arr = Ar \times 2 + 1$$

For example, if you set the remote address (Ar) to 50 decimal (32 hex), its SCL protocol addresses are as follows:

$$Ad \text{ (from Table B-2)} = 0F \text{ hex}$$

$$Ars = (32 \text{ hex}) \times 2 = 64 \text{ hex}$$

$$Arr = (32 \text{ hex}) \times 2 + 1 = 65 \text{ hex}$$

Remote Operation Flag

Some commands can be used only when the television demodulator is in the remote controlled state. When in remote control state, you cannot control the television demodulator from the front panel. The front panel display indicates the remote control state with the message “REMOTE CONTROLLED”

Two commands control the state of the remote flag. Use the command PWD= to enter the remote control state and set the remote flag to true (1). Use the DISC= command to resume front panel control and set the remote flag to false (0). Use the LOG? query to get the current state of the remote flag.

Command Types

There are two types of commands.

- Select commands end with an equal sign (=), such as “PRESET=”. Select commands set the television demodulator to operate in any mode allowed from the front panel.
- Query commands end with a question mark (?), such as “PRESET?”. Query commands tell the television demodulator to prepare to send a particular type of data to the PC.

Commands may be followed by one or more parameters specific to the command. Parameters are in binary format. Query commands often do not require parameters. The response data from a query command may contain several parameters.

For information on the syntax used for command definitions, refer to page B–11. The alphabetical list of commands and their parameters begins on page B–13.

Sending and Receiving Data

The PC must send commands and addresses in a certain order when writing data to and reading data from the television demodulator. The main steps in the communications process are as follows:

1. Send the identifying addresses.
2. Detect readiness of the television demodulator.
3. Send command and parameters.
4. Receive response/data.

Several types of communications are possible. Each type has a pattern of commands or phases that must be used. The following discussions introduce these communication phases: send address, send data, receive address, poll for messages, and get messages.

Send Address Phase

The PC uses Ad and Ars to address a particular television demodulator. The television demodulator configured with a matching address answers with either a ready response or a not ready response. Sending

this address data aborts all other communication on the bus. The following three cases show variations of the send address phase.

The PC addresses a television demodulator that is not ready to receive data:

PC > [DLE] [ENQ] [Ad] [Ars] *Addressing phase*

DS1000 > [DLE] [WACK] *Not ready response*

The PC addresses a television demodulator that is ready, and the PC sends data:

PC > [DLE] [ENQ] [Ad] [Ars] *Addressing phase*

DS1000 > [DLE] [ACK0] [Ad] [Ars] *Ready response*

PC > [DLE] [STX] [Data] [DLE] [ETX] *Data phase*

The PC addresses a television demodulator that is not ready, ignores the not ready response, and sends data:

PC > [DLE] [ENQ] [Ad] [Ars] *Addressing phase*

DS1000 > [DLE] *Aborted ready response*

PC > [DLE] [STX] [Data] [DLE] [ETX] *Data phase*

The PC can ignore the not-ready response and transmit the addressing phase and data phase sequentially. In this case, the television demodulator aborts the not ready response after receiving the first byte of the data phase. The PC receives only a DLE character.

When sending data, Ad and Ars can be replaced by FF hex, a broadcast address. When the television demodulator sends a ready response, it will send its real address. You can use this broadcast address to determine the address of a television demodulator. The wild card remote address is always a send address phase.

Send Data Phase

The send data phase begins with a command and may be followed by one or more parameters specific to the command. Two techniques for sending data are possible.

The PC addresses a television demodulator that is ready and sends data:

PC > [DLE] [ENQ] [Ad] [Ars] *Addressing phase*

DS1000 > [DLE] [ACK0] [Ad] [Ars] *Ready response*

PC > [DLE] [STX] [Data] [DLE] [ETX] *Data phase*

The PC addresses a television demodulator that is not ready, ignores the not ready response, and sends data:

PC > [DLE] [ENQ] [Ad] [Ars] *Addressing phase*

DS1000 > [DLE] *Aborted ready response*

PC > [DLE] [STX] [Data] [DLE] [ETX] *Data phase*

The PC can ignore the not-ready response and transmit the addressing phase and data phase sequentially. In this case, the television demodulator aborts the not ready response after receiving the first byte of the data phase. The PC receives only a DLE character.

If the byte 10 hex is part of the data, this byte is sent twice so that it is not confused with DLE ETX (10 hex), which ends the data phase.

Receive Address Phase

To acquire data from the television demodulator, the PC first sends the Ad and Arr addresses to identify the television demodulator. This address phase aborts other communication on the same bus. The television demodulator responds with a not ready phase if it does not have the requested data. It responds with a ready phase followed by a data phase when it has data. The receive data phase contains the Ad and Arr addresses to identify the responding television demodulator.

Examples of receive communication between the PC and the television demodulator follows with descriptions in italics.

The PC addresses a television demodulator that has no data available:

PC > [DLE] [ENQ] [Ad] [Arr] *Addressing phase*

DS1000 > [DLE] [WACK] *Not Ready response*

The PC addresses a television demodulator that has data available, and the television demodulator returns the data:

PC > [DLE] [ENQ] [Ad] [Arr] *Addressing phase*

DS1000 > [DLE] [STX] [Ad] [Arr] [Data] [DLE] [ETX]
 Ready response and data phase

If the byte 10 hex is part of the data, this byte is sent twice so that it is not confused with DLE ETX (10 hex), which ends the data phase.

Polling for Status Messages

If a television demodulator has a message, it does not send it to the PC, because more than one television demodulator can be connected to the same remote interface bus. To avoid data contention, the PC uses polling to check for messages.

Polling is done with the PATH? command. PATH? returns an empty string if the television demodulator has no message, and returns the path if a message is available. The path contains the addresses Ad and Ars (see *Addresses* on page B-3).

The following example is one continuous polling communication between the PC and the television demodulator. The values for Ad, Ars, and Arr can be calculated according to instructions on page B-3.

The PC addresses a television demodulator that is busy, repeats the addressing phase until the television demodulator returns a ready phase, then the PC sends the “PATH?” command.

```
PC > [DLE] [ENQ] [Ad] [Ars]      Send Addressing phase
DS1000 >[DLE] [WACK]             Not Ready response
PC > [DLE] [ENQ] [Ad] [Ars]      Send Addressing phase
DS1000 > [DLE] [ACK0] [Ad] [Ars]  Ready response
PC > [DLE] [STX] ['PATH?'] [DLE] [ETX]  Data phase
```

After receiving the PATH? command, the television demodulator places its answer in its transmit buffer. The PC tries to retrieve the message with a receive cycle, but the television demodulator has not processed the answer yet.

```
PC > [DLE] [ENQ] [Ad] [Arr]      Receive Addressing phase
DS1000 > [DLE] [WACK]           Not Ready phase
```

The PC repeats the addressing phase until the television demodulator is ready and transmits its data phase. There is no data included, because the television demodulator has no message.

```
PC > [DLE] [ENQ] [Ad] [Arr]      Receive Addressing phase
```

DS1000 > [DLE] [STX] [Ad] [Arr] [DLE] [ETX]
Data phase

The PC continuously polls the television demodulator.

PC > [DLE] [ENQ] [Ad] [Ars] *Send Addressing phase*

DS1000 > [DLE] [ACK0] [Ad] [Ars] *Ready phase*

PC > [DLE] [STX] ['PATH?'] [DLE] [ETX] *Data phase*

PC > [DLE] [ENQ] [Ad] [Arr] *Receive Addressing phase*

The television demodulator responds with data when it has a message. The [data] is the path, Ad Ars, which indicates that a message is available from the responding television demodulator.

DS1000 > [DLE] [STX] [Ad] [Arr] [data] [DLE] [ETX]
Data phase

Getting a Message

Polling a television demodulator only tells the PC if a message is available. To receive the message, you must use the MSG? command.

The following example shows how to use the MSG? command to retrieve a status message from a television demodulator.

The PC addresses a television demodulator that is busy and repeats the addressing phase until the television demodulator returns a ready phase. The PC then sends the “MSG?” command.

PC > [DLE] [ENQ] [Ad] [Ars] *Send Addressing phase*

DS1000 > [DLE] [ACK0] [Ad] [Ars] *Ready phase*

PC > [DLE] [STX] ['MSG?'] [DLE] [ETX] *Data phase*

After receiving the MSG? command, the television demodulator places its answer in its transmit buffer, and the PC retrieves the message with a receive phase. The data in this example (20h) is the test message. Other bit patterns are listed with the MSG? command.

PC > [DLE] [ENQ] [Ad] [Arr] *Receiving addressing phase*

DS1000 > [DLE] [STX] [Ad] [Arr] [20h] [DLE] [ETX]
Data phase

The PC acknowledges the data by sending the MSG= command followed by the data bit pattern. The PC resumes polling, but clears the message data as it reads the message.

PC > [DLE] [ENQ] [Ad] [Ars] *Send addressing phase*

DS1000 > [DLE] [ACK0] [Ad] [Ars] *Ready phase*

PC > [DLE] [STX] ['MSG='] [20h] [DLE] [ETX] *Data phase*

Command Syntax

The command descriptions follow a consistent format. The elements of that format are discussed here.

Description. Gives the function of the command, conditions of its use, and its interactions with other commands.

Syntax. Gives the valid select and query command forms. The required arguments are listed in their proper order.

For example, in the syntax definition

```
PATH= <Ad><Ars>
```

the arguments <Ad> and <Ars> are required in the order indicated.

Arguments. The arguments to a command are defined along with their range of values.

Returns. Defines the data returned in response to a command query.

Data Types

Data sent with a command or received from a query may be of the types listed in Table B–3.

Table B–3: Data types used in remote communication

Data type	Description
byte	8 bits, ordered highest to lowest (b7, b6, b5, b4, b3, b2, b1, b0).
word	16 bits, sent as 2 bytes, with the MSB first.
character (char)	Transferred as a single byte, representing an ASCII character. Char(10) would indicate a string containing 10 characters, such as 'ABCDEFGHIJ'.
Boolean	0 or 1, representing an off or on state.
bitmap	A string of bits with a definite length, where each bit represents the state of a parameter.

Data Offset

The offset is the relative position of a data item in the transmitted or received data. The first bit in a data transfer is number 1, so the first byte has an offset of 1.

Remote Command Descriptions

The following remote commands appear in alphabetical order.

AFC

Sets or requests the current AFC status. The television demodulator must be in the remote state to use this command.

Syntax

AFC=
AFC?

Arguments

<afc_state> Either 0 for off or 1 for on.

Examples

Command	Result
'AFC=' 1	AFC control is set to on.

AUD_OUT

Selects or requests the audio output mode. The television demodulator must be in the remote state to use this command.

Syntax

AUD_OUT= <aud_val>
 AUD_OUT? <aud_status>

Arguments

Argument	Format	Description
<aud_val>	byte	Left/Right (PAL) Left/Right (NTSC) 0: Mono1/Mono1 Mono/Mono 1: Mono2/Mono2 Mono/SAP 2: Mono1/Mono2 Stereo/Stereo 3: Stereo/Stereo SAP/SAP
<aud_status>	byte	0: Mute 1: FM/Nicam Mono1 2: FM/Nicam Mono2 3: FM/Nicam Mono1/Mono2 4: Stereo 5: BTSC SAP 6: BTSC Mono 7: BTSC Mono/SAP 8: BTSC Mono/Mute

Examples

Command	Result
'AUD_OUT=' 2	Audio output mode set to dual mono for PAL systems, or stereo for NTSC systems.

AUD_PREF

Sets or requests the current audio control preference if both FM and NICAM signals are present. The television demodulator must be in the remote state to use this command.

Syntax

AUD_PREF= <ap_state>
AUD_PREF?

Arguments

<ap_state> is either 0 for FM or 1 for NICAM.

Examples

Command	Result
'AUD_PREF=' 1	Audio preference is set to NICAM.

BTSC

Sets or requests the stereo and SAP noise threshold for the BTSC controller. The television demodulator must be in the remote state to use this command.

Syntax

BTSC= <stnt_val><sapnt_val>
BTSC?

Arguments

Byte offset	Argument	Format	Description
1	<stnt_val>	byte	Sets the stereo noise threshold in the BTSC controller. Range is 0 to 15.
2	<sapnt_val>	byte	Sets the SAP noise threshold in the BTSC controller. Range is 0 to 15

Examples

Command	Result
'BTSC=' 10 7	BTSC stereo noise threshold set to level 10. BTSC SAP noise threshold set to level 7.

CHANNEL

Sets or requests the selected channel record number and frequency table of the television demodulator. Sending the CHANNEL= command automatically sets the tuning mode to CHANNEL. The television demodulator must be in the remote state to use this command. For the query command, set TUNING to mode 0.

Syntax

CHANNEL=<table><channel_rec>
CHANNEL?

Arguments

Byte offset	Argument	Description		
1	<table>	Selects the table of channels from one of the following: <table border="0" style="width: 100%; border-collapse: collapse;"> <tr> <td style="vertical-align: top; width: 50%; border-right: 1px solid black;"> NTSC: 0: User defined table 1: CATV HRC 2: CATV IRC 3: CATV STD 4: STDOFST 5: IRC 6: HRC 7: B'CAST </td> <td style="vertical-align: top; width: 50%;"> PAL: 0: User defined table 1: UHF EUROPA 2: UHF CHINA 3: VHF EUROPA 4: VHF FRANCE 5: VHF ITALY 6: VHF AUSTRALIA 7: VHF CHINA 8: VHF IRELAND 9: VHF N. ZEALAND 10: VHF S. AFRICA 11: VHF OIRT 12: VHF CCIR </td> </tr> </table>	NTSC: 0: User defined table 1: CATV HRC 2: CATV IRC 3: CATV STD 4: STDOFST 5: IRC 6: HRC 7: B'CAST	PAL: 0: User defined table 1: UHF EUROPA 2: UHF CHINA 3: VHF EUROPA 4: VHF FRANCE 5: VHF ITALY 6: VHF AUSTRALIA 7: VHF CHINA 8: VHF IRELAND 9: VHF N. ZEALAND 10: VHF S. AFRICA 11: VHF OIRT 12: VHF CCIR
NTSC: 0: User defined table 1: CATV HRC 2: CATV IRC 3: CATV STD 4: STDOFST 5: IRC 6: HRC 7: B'CAST	PAL: 0: User defined table 1: UHF EUROPA 2: UHF CHINA 3: VHF EUROPA 4: VHF FRANCE 5: VHF ITALY 6: VHF AUSTRALIA 7: VHF CHINA 8: VHF IRELAND 9: VHF N. ZEALAND 10: VHF S. AFRICA 11: VHF OIRT 12: VHF CCIR			
2	<channel_rec>	Selects the record number in the selected table. The table record number corresponds to a particular channel number. Refer to <i>Appendix D</i> for the record number associated with each channel number in the selected table.		

Examples

Command	Result
'CHANNEL=' 1 18	NTSC: Table 1, CATV HRC frequency table is selected. Channel record 18 selected = channel number 19 PAL: UHF EUROPA frequency table selected. Channel record 18 selected = channel number 39

DISC

Puts the television demodulator in the local state, which enables the front panel controls and clears the remote flag. Use the command PWD to enter the remote state and set the remote flag.

Syntax

DISC=

Arguments

none

FREQ

Sets or requests the demodulation frequency. Setting the frequency automatically sets the tuning mode to FREQ TUNE. See the command description for TUNING. The television demodulator must be in the remote state to use this command.

Syntax

FREQ= <freqH_val><freqL_val>

FREQ?

Arguments

Byte offset	Argument	Format	Description
1	<freqH_val>	word: [x yyy]	Sets the integer part of the frequency in MHz. X = frequency in MHz/256. YYY = frequency in MHz – (x * 256). The range is 45 to 860.
3	<freqL_val>	word: [x yyy]	Sets the fractional part of the frequency in kHz. X = frequency in kHz/256. YYY = frequency in kHz – (x * 256). The range is 0 to 999.

Examples

Command	Result
'FREQ=' [1 100 0 250]	freqH: [1 100] = 1x256+100 = 356 MHz freqL: [0 250] = 250 kHz The frequency set is 356.25 MHz.

IDN

Sets or requests the television demodulator identification. The query returns the device name ('DS1001') followed by the software version number ('V01.00'), and a defined name <unit_loc>. You can assign a device name with IDN= <unit_loc>. The television demodulator must be in the remote state to use this command.

Syntax

```
IDN= <unit_loc>
IDN?<device> <version><unit_loc>
```

Arguments

<unit_loc> up to 20 characters
 <device> <version><unit_loc>

Returns

Byte offset	Argument	Format	Description
1	<device>	Char(10)	Model ('DS1001')
11	<version>	Char(6)	Software version ('V01.00')
17	<unit_loc>	Char(20)	Custom name ('DEM0D2')

Examples

Command	Result
'IDN?'	'DS1001 V01.00' 'DEM0D2' The model is DS1001, the software is version 1.00 and the custom name is DEM0D2.

LOG? (Query only)

Requests the remote state of the television demodulator. Use the command PWD to start remote operation and DISC to return to local operation.

Syntax

LOG?

Arguments

<remote flag> 0 for local control, 1 for remote

Returns

<remote flag>

Examples

```
'LOG?'
```

```
0
```

The television demodulator is in the local state.

MSG

Clears or requests the status of the television demodulator. The MSG? command causes the television demodulator to place any messages in its transmit buffer. Use a receive phase to return the message. The television demodulator can be polled continuously; see page B-8.

MSG= clears the message bit(s) matching the true bits in the message byte <state>. The television demodulator must be in the remote state to use the MSG= command.

Syntax

MSG=<state>

MSG?

Arguments

<state> is 1h to FFh. FFh clears all message bits.

Returns

Bitmap of <state>	Description of True state (1)
b7: Invalid remote command	Television demodulator received an invalid command
b6: Wrong remote parameter	Television demodulator received the wrong parameter
b0 – b5: Not used	

Examples

'MSG?'
128 decimal
which equals 80h or 10000000b. This message indicates an invalid command.

MSG_C

Enables or disables message generation in the television demodulator. Setting MSG_C from 1 to 0 clears all pending messages. The television demodulator must be in the remote state to use this command.

Syntax

MSG_C= <msg_state>
MSG_C?

Arguments

<msg_state> one byte, either 1 to enable messages or 0 to disable them.

Examples

Command	Result
'MSG_C=' 1	The television demodulator may now generate messages.

PATH

Polls the television demodulator to check for status messages. The television demodulator returns its <Ad><Ars> addresses when there is a message and a null string when there are no messages. Use the MSG? command to get the actual status message. If the messages are disabled with the MSG_C command, the television demodulator will not have a message.

For more information on using the PATH command for polling, refer to page B-8.

Syntax

```
PATH= <Ad><Ars>
PATH?
```

Returns

Device address	Description
<Ad>	Device address, always [0F hex] for the television demodulator.
<Ars>	Remote address, calculated on page B-3.

Examples

Command	Result
'PATH?'	<Ad><Ars> The television demodulator has a message and is ready to send it. The <Ad><Ars> addresses are contained in the <data> returned.

PRESET

Sets or requests the settings for one of the 20 programs without affecting the present operation of the television demodulator. Use the RECPRT command to activate a preset program number. The television demodulator must be in the remote state to use this command.

Syntax

PRESET=<pres_nr><settings_data>
PRESET?

Arguments

<pres_nr> is the program number to set or query. Range 1–20.
<settings_data> Refer to the SETT command for a definition of these parameters.

Examples

Command	Result
'PRESET?' 10	<settings_data> Returns the program data for number 10.

PWD

Puts the television demodulator in the remote state and sets the remote flag. The front panel is disabled when in the remote state. Use the command DISC to enter the local state and clear the remote flag.

Syntax

PWD=

Arguments

none

RECPRT

Selects and makes active the current program (preset) or requests the current number. The data in <prog_nr> becomes the current setting of the television demodulator. This command sets the tuning mode to PROGRAM. This command is allowed only when the remote flag is true and when TUNING = 4, indicating the PROGRAM mode.

Syntax

```
RECPRT= <prog_nr>  
RECPRT?
```

Arguments

<prog_nr> one byte in the range 1 to 20 to indicate the program number.

Examples

Command	Result
'RECPRT?'	12 The program number 12 is the current active program.

REPORT? (Query only)

Requests the operating state of the television demodulator. The response is 0 when an active input signal is detected and 2 when no signal is detected. The television demodulator must be in the remote state to use this command.

Syntax

REPORT? <tic_state>

Arguments

<tic_state> one byte, either 0 to indicate an active signal, or 2 to indicate no input signal.

Examples

Command	Result
'REPORT?'	2 The television demodulator does not detect a signal.

SETT

Sets or requests several operating parameters of the television demodulator. With the SETT command, you can set several parameters at once instead of using several different commands. SETT can replace the following commands: **FREQ**, **AFC**, **AUD_PREF**, **STRAP**, **ZCP**, **BTSC** and **AUD_OUT**. The new settings are effective immediately. The television demodulator must be in the remote state to use this command.

Syntax

SETT=<settings_data>
SETT?

Arguments

<setting_data>

Byte offset	Setting	Range	Command/desc																				
1-2	freqH_val	45 to 860	FREQ																				
3-4	freqL_val	0 to 999	FREQ																				
5	status_flags	bitmap status byte	Set the bit true (1) to enable the associated function: b7: x b6: ZCP control b5: audio mode selection bit 1 b4: audio mode selection bit 0 b3: audio preference NICAM b2: Sound trap control b1: AFC control b0: off-channel frequency																				
Audio mode, bits b4 & b5:																							
<table border="0"> <tr> <td>B4</td> <td>B5</td> <td>PAL mode</td> <td>NTSC mode</td> </tr> <tr> <td>0</td> <td>0</td> <td>mono1</td> <td>mono</td> </tr> <tr> <td>1</td> <td>0</td> <td>mono2</td> <td>mono/SAP</td> </tr> <tr> <td>0</td> <td>1</td> <td>mono1/mono2</td> <td>stereo</td> </tr> <tr> <td>1</td> <td>1</td> <td>stereo</td> <td>SAP</td> </tr> </table>				B4	B5	PAL mode	NTSC mode	0	0	mono1	mono	1	0	mono2	mono/SAP	0	1	mono1/mono2	stereo	1	1	stereo	SAP
B4	B5	PAL mode	NTSC mode																				
0	0	mono1	mono																				
1	0	mono2	mono/SAP																				
0	1	mono1/mono2	stereo																				
1	1	stereo	SAP																				
6-7	ZCP line number	0 to 21	ZCP																				
8	ZCP position	0 to 4	ZCP																				
9	BTSC stereo noise	0 to 15	BTSC																				
10	BTSC SAP noise	0 to 15	BTSC																				

Examples

Command	Result
'SETT?'	Returns the current settings of the television demodulator.

STRAP

Sets or requests the status of the sound trap. The television demodulator must be in the remote state to use this command.

Syntax

STRAP= <strap_state>
STRAP?

Arguments

<strap_state> Either 1 for On or 0 for Off.

Examples

Command	Result
'STRAP=' 1	Sound trap is on.

TUNING

Sets or requests the tuning mode. The tuning mode can be by channel, frequency, or from a programmed (preset) setting. The television demodulator must be in the remote state to use this command.

Syntax

```
TUNING=<tune_mode>  
TUNING?
```

Arguments

<tune_mode> may be set to any of three modes:

- 0, Channel tuning, allows tuning by channel number.
- 3, Frequency tuning, allows tuning by frequency in network standard increments.
- 4, Programmed tuning, allows tuning by loading a stored preset.

Examples

Command	Result
'TUNING?'	4: Returned data of [4] means television demodulator is in program (preset) mode.

ZCP

Sets or requests the status of the zero carrier pulse (ZCP). The television demodulator must be in the remote state to use this command.

Syntax

ZCP= <zcp_state><zcp_line_no><zcp_position>
ZCP?

Arguments

Byte offset	Arguments	Range									
1	<zcp_state>	0 for Off, 1 for On									
2-3	<zcp_line_no>	<p>Sets the line number on which the ZCP is activated. The range is 0 to 20. The <zcp_line_no> translates to an actual video line number as follows:</p> <table border="1"> <thead> <tr> <th>Line No.</th> <th>PAL</th> <th>NTSC</th> </tr> </thead> <tbody> <tr> <td>0-10:</td> <td>6-16</td> <td>10-20 (Field 1)</td> </tr> <tr> <td>11-21:</td> <td>319-329</td> <td>10-20 (Field 2)</td> </tr> </tbody> </table>	Line No.	PAL	NTSC	0-10:	6-16	10-20 (Field 1)	11-21:	319-329	10-20 (Field 2)
Line No.	PAL	NTSC									
0-10:	6-16	10-20 (Field 1)									
11-21:	319-329	10-20 (Field 2)									
4	<zcp_position>	ZCP position on the selected line. Range is 0 to 4.									

Examples

Command	Result
'ZCP=' 1 13 1	<p>NTSC: ZCP is active on line 12 (field 2) in position 1.</p> <p>PAL: ZCP is activate on line 321 in position 1.</p>

Appendix C: Service



WARNING. To avoid personal injury or damage to the unit, be sure that the power is **not** supplied to the television demodulator while performing the procedures in this section.

This section contains instructions for user service and preventative maintenance. The only serviceable part is the fuse, which is available on the rear panel.

There are no user serviceable parts within the unit. Please return it to a Tektronix Service Center for service and calibration.

Packaging for Shipment

If it becomes necessary to ship the television demodulator to a Tektronix Service Center, follow these instructions:

1. Write the following on a tag attached to the product: the product owner, complete address and phone number of someone at your firm who can be contacted, the product serial number, and a description of the required service.
2. Package the product in the original packaging materials. If they are not available, follow these directions:
 - a. Obtain a carton of corrugated cardboard having inside dimensions at least 6 in (150 mm) greater than the dimensions of the instrument.
 - b. Surround the product with a protective bag (anti-static preferred).
 - c. Pack dunnage or urethane foam between the product and the carton. If you use Styrofoam kernels, overfill the box and compress by closing the lid. There should be 3 inches (75 mm) of tightly packed cushioning on all sides of the instrument.
3. Seal the carton with shipping tape, an industrial stapler, or both.

Replacing the Fuse

1. Disconnect the power cable from the television demodulator rear panel.
2. Remove the fuse holder by inserting a suitable instrument on either side of the holder and pulling straight out.
3. Remove the old fuse and replace it with a new fuse of the same type. Use only 250 V, 1.6 A time-delayed fuses.
4. Replace the fuse holder ensuring that the holder clicks back into its socket.

Cleaning the Exterior

The instrument should be cleaned often enough to prevent dust and dirt from accumulating. Dirt acts as a thermal insulator, preventing effective heat dissipation and providing high-resistance electrical leakage paths between conductors or components in a humid environment.



CAUTION. *To avoid damaging the unit, do not allow water to get inside any enclosed assembly or component. Do not clean any plastic materials with benzene, toluene, xylene, acetone, or similar solvents, because they may damage the plastic.*

Clean the dust from the outside of the instrument with a soft, dry cloth or small brush. A brush is especially useful for removing dust from around the buttons and connectors.

Appendix D: Channel Tables

This section contains the frequency and channel tables used by the television demodulator system. When manually selecting a channel, the television demodulator displays the channel name and number. When selecting a channel using the remote serial commands, the channel record number provides access to the channels.

Table	Name	Standard	Channels	Page
D-1	CATV HRC channel table	NTSC	99	D-2
D-2	CATV IRC channel table	NTSC	98	D-3
D-3	CATV Standard channel table	NTSC	124	D-5
D-4	Standard channel table	NTSC	124	D-7
D-5	IRC channel table	NTSC	99	D-9
D-6	HRC channel table	NTSC	99	D-10
D-7	Broadcast channel table	NTSC	68	D-12
D-8	UHF Europa channel table	PAL	49	D-13
D-9	UHF China channel table	PAL	44	D-14
D-10	VHF Europa channel table	PAL	55	D-15
D-11	VHF France channel table	PAL	10	D-16
D-12	VHF Italy channel table	PAL	10	D-16
D-13	VHF Australia channel table	PAL	13	D-16
D-14	VHF China channel table	PAL	12	D-17
D-15	VHF Ireland channel table	PAL	9	D-17
D-16	VHF New Zealand channel table	PAL	11	D-17
D-17	VHF South Africa channel table	PAL	9	D-18
D-18	VHF OIRT channel table	PAL	12	D-18
D-19	VHF CCIR channel table	PAL	11	D-18

Table D-1: CATV HRC channel table

Rec No.	Chan No.	Freq (MHz)	Rec No.	Chan No.	Freq (MHz)	Rec No.	Chan No.	Freq (MHz)
0	1	72.00	25	26	234.00	50	51	384.00
1	2	54.00	26	27	240.00	51	52	390.00
2	3	60.00	27	28	246.00	52	53	396.00
3	4	66.00	28	29	252.00	53	54	402.00
4	5	78.00	29	30	258.00	54	55	408.00
5	6	84.00	30	31	264.00	55	56	414.00
6	7	174.00	31	32	270.00	56	57	420.00
7	8	180.00	32	33	276.00	57	58	426.00
8	9	186.00	33	34	282.00	58	59	432.00
9	10	192.00	34	35	288.00	59	60	438.00
10	11	198.00	35	36	294.00	60	61	444.00
11	12	204.00	36	37	300.00	61	62	450.00
12	13	210.00	37	38	306.00	62	63	456.00
13	14	120.00	38	39	312.00	63	64	462.00
14	15	126.00	39	40	318.00	64	65	468.00
15	16	132.00	40	41	324.00	65	66	474.00
16	17	138.00	41	42	330.00	66	67	480.00
17	18	144.00	42	43	336.00	67	68	486.00
18	19	150.00	43	44	342.00	68	69	492.00
19	20	156.00	44	45	348.00	69	70	498.00
20	21	162.00	45	46	354.00	70	71	504.00
21	22	168.00	46	47	360.00	71	72	510.00
22	23	216.00	47	48	366.00	72	73	516.00
23	24	222.00	48	49	372.00	73	74	522.00
24	25	228.00	49	50	378.00	74	75	528.00

Table D-1: CATV HRC channel table (cont.)

Rec No.	Chan No.	Freq (MHz)	Rec No.	Chan No.	Freq (MHz)	Rec No.	Chan No.	Freq (MHz)
75	76	534.00	83	84	582.00	91	92	630.00
76	77	540.00	84	85	588.00	92	93	636.00
77	78	546.00	85	86	594.00	93	94	642.00
78	79	552.00	86	87	600.00	94	95	90.00
79	80	558.00	87	88	606.00	95	96	96.00
80	81	564.00	88	89	612.00	96	97	102.00
81	82	570.00	89	90	618.00	97	98	108.00
82	83	576.00	90	91	624.00	98	99	114.00

Table D-2: CATV IRC channel table

Rec No.	Chan No.	Freq (MHz)	Rec No.	Chan No.	Freq (MHz)	Rec No.	Chan No.	Freq (MHz)
0	2	55.25	12	14	121.25	24	26	235.25
1	3	61.25	13	15	127.25	25	27	241.25
2	4	67.25	14	16	133.25	26	28	247.25
3	5	79.25	15	17	139.25	27	29	253.25
4	6	85.25	16	18	145.25	28	30	259.25
5	7	175.25	17	19	151.25	29	31	265.25
6	8	181.25	18	20	157.25	30	32	271.25
7	9	187.25	19	21	163.25	31	33	277.25
8	10	193.25	20	22	169.25	32	34	283.25
9	11	199.25	21	23	217.25	33	35	289.25
10	12	205.25	22	24	223.25	34	36	295.25
11	13	211.25	23	25	229.25	35	37	301.25

Table D-2: CATV IRC channel table (cont.)

Rec No.	Chan No.	Freq (MHz)	Rec No.	Chan No.	Freq (MHz)	Rec No.	Chan No.	Freq (MHz)
36	38	307.25	57	59	433.25	78	80	559.25
37	39	313.25	58	60	439.25	79	81	565.25
38	40	319.25	59	61	445.25	80	82	571.25
39	41	325.25	60	62	451.25	81	83	577.25
40	42	331.25	61	63	457.25	82	84	583.25
41	43	337.25	62	64	463.25	83	85	589.25
42	44	343.25	63	65	469.25	84	86	595.25
43	45	349.25	64	66	475.25	85	87	601.25
44	46	355.25	65	67	481.25	86	88	607.25
45	47	361.25	66	68	487.25	87	89	613.25
46	48	367.25	67	69	493.25	88	90	619.25
47	49	373.25	68	70	499.25	89	91	625.25
48	50	379.25	69	71	505.25	90	92	631.25
49	51	385.25	70	72	511.25	91	93	637.25
50	52	391.25	71	73	517.25	92	94	643.25
51	53	397.25	72	74	523.25	93	95	91.25
52	54	403.25	73	75	529.25	94	96	97.25
53	55	409.25	74	76	535.25	95	97	103.25
54	56	415.25	75	77	541.25	96	98	109.25
55	57	421.25	76	78	547.25	97	99	115.25
56	58	427.25	77	79	553.25			

Table D-3: CATV standard channel table

Rec No.	Chan No.	Freq (MHz)	Rec No.	Chan No.	Freq (MHz)	Rec No.	Chan No.	Freq (MHz)
0	2	55.25	25	27	241.25	50	52	391.25
1	3	61.25	26	28	247.25	51	53	397.25
2	4	67.25	27	29	253.25	52	54	403.25
3	5	77.25	28	30	259.25	53	55	409.25
4	6	83.25	29	31	265.25	54	56	415.25
5	7	175.25	30	32	271.25	55	57	421.25
6	8	181.25	31	33	277.25	56	58	427.25
7	9	187.25	32	34	283.25	57	59	433.25
8	10	193.25	33	35	289.25	58	60	439.25
9	11	199.25	34	36	295.25	59	61	445.25
10	12	205.25	35	37	301.25	60	62	451.25
11	13	211.25	36	38	307.25	61	63	457.25
12	14	121.25	37	39	313.25	62	64	463.25
13	15	127.25	38	40	319.25	63	65	469.25
14	16	133.25	39	41	325.25	64	66	475.25
15	17	139.25	40	42	331.25	65	67	481.25
16	18	145.25	41	43	337.25	66	68	487.25
17	19	151.25	42	44	343.25	67	69	493.25
18	20	157.25	43	45	349.25	68	70	499.25
19	21	163.25	44	46	355.25	69	71	505.25
20	22	169.25	45	47	361.25	70	72	511.25
21	23	217.25	46	48	367.25	71	73	517.25
22	24	223.25	47	49	373.25	72	74	523.25
23	25	229.25	48	50	379.25	73	75	529.25
24	26	235.25	49	51	385.25	74	76	535.25

Table D-3: CATV standard channel table (cont.)

Rec No.	Chan No.	Freq (MHz)	Rec No.	Chan No.	Freq (MHz)	Rec No.	Chan No.	Freq (MHz)
75	77	541.25	92	94	643.25	109	111	715.25
76	78	547.25	93	95	91.25	110	112	721.25
77	79	553.25	94	96	97.25	111	113	727.25
78	80	559.25	95	97	103.25	112	114	733.25
79	81	565.25	96	98	109.25	113	115	739.25
80	82	571.25	97	99	115.25	114	116	745.25
81	83	577.25	98	100	649.25	115	117	751.25
82	84	583.25	99	101	655.25	116	118	757.25
83	85	589.25	100	102	661.25	117	119	763.25
84	86	595.25	101	103	667.25	118	120	769.25
85	87	601.25	102	104	673.25	119	121	775.25
86	88	607.25	103	105	679.25	120	122	781.25
87	89	613.25	104	106	685.25	121	123	787.25
88	90	619.25	105	107	691.25	122	124	793.25
89	91	625.25	106	108	697.25	123	125	799.25
90	92	631.25	107	109	703.25			
91	93	637.25	108	110	709.25			

Table D-4: Standard channel table

Rec No.	Chan No.	Freq (MHz)	Rec No.	Chan No.	Freq (MHz)	Rec No.	Chan No.	Freq (MHz)
0	2	55.25	25	13	211.25	50	47	361.26
1	3	61.25	26	23	217.25	51	48	367.26
2	4	67.25	27	24	223.25	52	49	373.26
3	5	77.25	28	25	229.26	53	50	379.26
4	6	83.25	29	26	235.26	54	51	385.26
5	95	91.25	30	27	241.26	55	52	391.26
6	96	97.25	31	28	247.26	56	53	397.26
7	97	103.25	32	29	253.26	57	54	403.25
8	98	109.25	33	30	259.26	58	55	409.25
9	99	115.25	34	31	265.26	59	56	415.25
10	14	121.26	35	32	271.26	60	57	421.25
11	15	127.26	36	33	277.26	61	58	427.25
12	16	133.26	37	34	283.26	62	59	433.25
13	17	139.25	38	35	289.26	63	60	439.25
14	18	145.25	39	36	295.26	64	61	445.25
15	19	151.25	40	37	301.26	65	62	451.25
16	20	157.25	41	38	307.26	66	63	457.25
17	21	163.25	42	39	313.26	67	64	463.25
18	22	169.25	43	40	319.26	68	65	469.25
19	7	175.25	44	41	325.26	69	66	475.25
20	8	181.25	45	42	331.27	70	67	481.25
21	9	187.25	46	43	337.26	71	68	487.25
22	10	193.25	47	44	343.26	72	69	493.25
23	11	199.25	48	45	349.26	73	70	499.25
24	12	205.25	49	46	355.26	74	71	505.25

Table D-4: Standard channel table (cont.)

Rec No.	Chan No.	Freq (MHz)	Rec No.	Chan No.	Freq (MHz)	Rec No.	Chan No.	Freq (MHz)
75	72	511.25	92	89	613.25	109	111	715.25
76	73	517.25	93	90	619.25	110	112	721.25
77	74	523.25	94	91	625.25	111	113	727.25
78	75	529.25	95	92	631.25	112	114	733.25
79	76	535.25	96	93	637.25	113	115	739.25
80	77	541.25	97	94	643.25	114	116	745.25
81	78	547.25	98	100	649.25	115	117	751.25
82	79	553.25	99	101	655.25	116	118	757.25
83	80	559.25	100	102	661.25	117	119	763.25
84	81	565.25	101	103	667.25	118	120	769.25
85	82	571.25	102	104	673.25	119	121	755.25
86	83	577.25	103	105	679.25	120	122	781.25
87	84	583.25	104	106	685.25	121	123	787.25
88	85	589.25	105	107	691.25	122	124	793.25
89	86	595.25	106	108	697.25	123	125	799.25
90	87	601.25	107	109	703.25			
91	88	607.25	108	110	709.25			

Table D-5: IRC channel table

Rec No.	Chan No.	Freq (MHz)	Rec No.	Chan No.	Freq (MHz)	Rec No.	Chan No.	Freq (MHz)
0	2	55.25	25	12	205.25	50	46	355.25
1	3	61.25	26	13	211.25	51	47	361.25
2	4	67.25	27	23	217.25	52	48	367.25
3	1	73.25	28	24	223.26	53	49	373.25
4	5	79.25	29	25	229.26	54	50	379.25
5	6	85.25	30	26	235.26	55	51	385.25
6	95	91.25	31	27	241.26	56	52	391.25
7	96	97.25	32	28	247.26	57	53	397.25
8	97	103.25	33	29	253.26	58	54	403.25
9	98	109.25	34	30	259.25	59	55	409.25
10	99	115.26	35	31	265.25	60	56	415.25
11	14	121.26	36	32	271.25	61	57	421.25
12	15	127.26	37	33	277.25	62	58	427.25
13	16	133.25	38	34	283.25	63	69	433.25
14	17	139.25	39	35	289.25	64	60	439.25
15	18	145.25	40	36	295.25	65	61	445.25
16	19	151.25	41	37	301.25	66	62	451.25
17	20	157.25	42	38	307.25	67	63	457.25
18	21	163.25	43	39	313.25	68	64	463.25
19	22	169.25	44	40	319.25	69	65	469.25
20	7	175.25	45	41	325.25	70	66	475.25
21	8	181.25	46	42	331.25	71	67	481.25
22	9	187.25	47	43	337.25	72	68	487.25
23	10	193.25	48	44	343.25	73	69	493.25
24	11	199.25	49	45	349.25	74	70	499.25

Table D-5: IRC channel table (cont.)

Rec No.	Chan No.	Freq (MHz)	Rec No.	Chan No.	Freq (MHz)	Rec No.	Chan No.	Freq (MHz)
75	71	505.25	83	79	553.25	91	87	601.25
76	72	511.25	84	80	559.25	92	88	607.25
77	73	517.25	85	81	565.25	93	89	613.25
78	74	523.25	86	82	571.25	94	90	619.25
79	75	529.25	87	83	577.25	95	92	625.25
80	76	535.25	88	84	583.25	96	92	631.25
81	77	541.25	89	85	589.25	97	93	637.25
82	78	547.25	90	86	595.25	98	94	643.25

Table D-6: HRC channel table

Rec No.	Chan No.	Freq (MHz)	Rec No.	Chan No.	Freq (MHz)	Rec No.	Chan No.	Freq (MHz)
0	2	54.00	13	16	132.00	26	13	210.00
1	3	60.00	14	17	138.00	27	23	216.00
2	4	66.00	15	18	144.00	28	24	222.00
3	1	72.00	16	19	150.00	29	25	228.00
4	5	78.00	17	20	156.00	30	26	234.00
5	6	84.00	18	21	162.00	31	27	240.00
6	95	90.00	19	22	168.00	32	28	246.00
7	96	96.00	20	7	174.00	33	29	252.00
8	97	102.00	21	8	180.00	34	30	258.00
9	98	108.00	22	9	186.00	35	31	264.00
10	99	114.00	23	10	192.00	36	32	270.00
11	14	120.00	24	11	198.00	37	33	276.00
12	15	126.00	25	12	204.00	38	34	282.00

Table D-6: HRC channel table (cont.)

Rec No.	Chan No.	Freq (MHz)	Rec No.	Chan No.	Freq (MHz)	Rec No.	Chan No.	Freq (MHz)
39	35	288.00	61	57	420.00	80	76	534.00
40	36	294.00	62	58	426.00	81	77	540.00
41	37	300.00	63	59	432.00	82	78	546.00
42	38	306.00	64	60	438.00	83	79	552.00
43	39	312.00	65	61	444.00	84	80	558.00
44	40	318.00	66	62	450.00	85	81	564.00
45	41	324.00	67	63	456.00	86	82	570.00
46	42	330.00	68	64	462.00	87	83	576.00
47	43	336.00	69	65	468.00	88	84	582.00
48	44	342.00	70	66	474.00	89	85	588.00
49	45	348.00	71	67	480.00	90	86	594.00
50	46	354.00	72	68	486.00	91	87	600.00
51	47	360.00	73	69	492.00	92	88	606.00
52	48	366.00	74	70	498.00	93	89	612.00
53	49	372.00	75	71	504.00	94	90	618.00
54	50	378.00	76	72	510.00	95	91	624.00
55	51	384.00	77	73	516.00	96	92	630.00
56	52	390.00	78	74	522.00	97	93	636.00
57	53	396.00	79	75	528.00	98	94	642.00

Table D-7: Broadcast channel table

Rec No.	Chan No.	Freq (MHz)	Rec No.	Chan No.	Freq (MHz)	Rec No.	Chan No.	Freq (MHz)
0	2	55.25	23	25	537.25	46	48	675.25
1	3	61.25	24	26	543.25	47	49	681.25
2	4	67.25	25	27	549.25	48	50	687.25
3	5	77.25	26	28	555.25	49	51	693.25
4	6	83.25	27	29	561.25	50	52	699.25
5	7	175.25	28	30	567.25	51	53	705.25
6	8	181.25	29	31	573.25	52	54	711.25
7	9	187.25	30	32	579.25	53	55	717.25
8	10	193.25	31	33	585.25	54	56	723.25
9	11	199.25	32	34	591.25	55	57	729.25
10	12	205.25	33	35	597.25	56	58	735.25
11	13	211.25	34	36	603.25	57	59	741.25
12	14	471.25	35	37	609.25	58	60	747.25
13	15	477.25	36	38	615.25	59	61	753.25
14	16	483.25	37	39	621.25	60	62	759.25
15	17	489.25	38	40	627.25	61	63	765.25
16	18	495.25	39	41	633.25	62	64	771.25
17	19	501.25	40	42	639.25	63	65	777.25
18	20	507.25	41	43	645.25	64	66	783.25
19	21	513.25	42	44	651.25	65	67	789.25
20	22	519.25	43	45	657.25	66	68	795.25
21	23	525.25	44	46	663.25	67	69	801.25
22	24	531.25	45	47	669.25			

Table D-8: UHF Europa channel table

Rec No.	Chan No.	Freq (MHz)	Rec No.	Chan No.	Freq (MHz)	Rec No.	Chan No.	Freq (MHz)
0	21	471.25	17	38	607.25	34	55	743.25
1	22	479.25	18	39	615.25	35	56	751.25
2	23	487.25	19	40	623.25	36	57	759.25
3	24	495.25	20	41	631.25	37	58	767.25
4	25	503.25	21	42	639.25	38	59	775.25
5	26	511.25	22	43	647.25	39	60	783.25
6	27	519.25	23	44	655.25	40	61	791.25
7	28	527.25	24	45	663.25	41	62	799.25
8	29	535.25	25	46	671.25	42	63	807.25
9	30	543.25	26	47	679.25	43	64	815.25
10	31	551.25	27	48	687.25	44	65	823.25
11	32	559.25	28	49	695.25	45	66	831.25
12	33	567.25	29	50	703.25	46	67	839.25
13	34	575.25	30	51	711.25	47	68	847.25
14	35	583.25	31	52	719.25	48	69	855.25
15	36	591.25	32	53	727.25			
16	37	599.25	33	54	735.25			

Table D-9: UHF China channel table

Rec No.	Chan No.	Freq (MHz)	Rec No.	Chan No.	Freq (MHz)	Rec No.	Chan No.	Freq (MHz)
0	13	471.25	15	28	631.25	30	43	751.25
1	14	479.25	16	29	639.25	31	44	759.25
2	15	487.25	17	30	647.25	32	45	767.25
3	16	495.25	18	31	655.25	33	46	775.25
4	17	503.25	19	32	663.25	34	47	783.25
5	18	511.25	20	33	671.25	35	48	791.25
6	19	519.25	21	34	679.25	36	49	799.25
7	20	527.25	22	35	687.25	37	50	807.25
8	21	535.25	23	36	695.25	38	51	815.25
9	22	543.25	24	37	703.25	39	52	823.25
10	23	551.25	25	38	711.25	40	53	831.25
11	24	559.25	26	39	719.25	41	54	839.25
12	25	607.25	27	40	727.25	42	55	847.25
13	26	615.25	28	41	735.25	43	56	855.25
14	27	623.25	29	42	743.25			

Table D-10: VHF Europa channel table

Rec No.	Chan No.	Freq (MHz)	Rec No.	Chan No.	Freq (MHz)	Rec No.	Chan No.	Freq (MHz)
0	E2	48.25	19	E8	196.25	38	S25	335.25
1	E3	55.25	20	E9	203.25	39	S26	343.25
2	E4	62.25	21	E10	210.25	40	S27	351.25
3	S01	69.25	22	E11	217.25	41	S28	359.25
4	S02	76.25	23	E12	224.25	42	S29	367.25
5	S03	83.25	24	S11	231.25	43	S30	375.25
6	S1	105.25	25	S12	238.25	44	S31	383.25
7	S2	112.25	26	S13	245.25	45	S32	391.25
8	S3	119.25	27	S14	252.25	46	S33	399.25
9	S4	126.25	28	S15	259.25	47	S34	407.25
10	S5	133.25	29	S16	266.25	48	S35	415.25
11	S6	140.25	30	S17	273.25	49	S36	423.25
12	S7	147.25	31	S18	280.25	50	S37	431.25
13	S8	154.25	32	S19	287.25	51	S38	439.25
14	S9	161.25	33	S20	294.25	52	S39	447.25
15	S10	168.25	34	S21	303.25	53	S40	455.25
16	E5	175.25	35	S22	311.25	54	S41	463.25
17	E6	182.25	36	S23	319.25			
18	E7	189.25	37	S24	327.25			

Table D-11: VHF France channel table

Rec No.	Chan No.	Freq (MHz)	Rec No.	Chan No.	Freq (MHz)	Rec No.	Chan No.	Freq (MHz)
0	A	47.75	4	1	176.00	8	5	208.00
1	B	55.75	5	2	184.00	9	6	216.00
2	C1	60.50	6	3	192.00			
3	C	63.55	7	4	200.00			

Table D-12: VHF Italy channel table

Rec No.	Chan No.	Freq (MHz)	Rec No.	Chan No.	Freq (MHz)	Rec No.	Chan No.	Freq (MHz)
0	A	53.75	4	E	183.75	8	H1	217.25
1	B	62.25	5	F	192.25	9	H2	224.25
2	C	82.25	6	G	201.25			
3	D	175.25	7	H	210.25			

Table D-13: VHF Australia channel table

Rec No.	Chan No.	Freq (MHz)	Rec No.	Chan No.	Freq (MHz)	Rec No.	Chan No.	Freq (MHz)
0	0	46.25	5	5	102.25	10	9	196.25
1	1	57.25	6	6A	138.25	11	10	209.25
2	2	64.25	7	6	175.25	12	11	216.25
3	3	86.25	8	7	182.25			
4	4	95.25	9	8	189.25			

Table D-14: VHF China channel table

Rec No.	Chan No.	Freq (MHz)	Rec No.	Chan No.	Freq (MHz)	Rec No.	Chan No.	Freq (MHz)
0	1	47.75	4	5	85.25	8	9	192.25
1	2	57.75	5	6	168.25	9	10	200.25
2	3	65.75	6	7A	176.25	10	11	208.25
3	4	77.25	7	8	184.25	11	112	216.25

Table D-15: VHF Ireland channel table

Rec No.	Chan No.	Freq (MHz)	Rec No.	Chan No.	Freq (MHz)	Rec No.	Chan No.	Freq (MHz)
0	A	45.75	3	D	175.25	6	G	199.25
1	B	53.75	4	E	183.25	7	H	207.25
2	C	61.75	5	F	191.25	8	J	215.25

Table D-16: VHF New Zealand channel table

Rec No.	Chan No.	Freq (MHz)	Rec No.	Chan No.	Freq (MHz)	Rec No.	Chan No.	Freq (MHz)
0	1	45.25	4	5	182.25	8	9	210.25
1	2	55.25	5	6	189.25	9	10	217.25
2	3	62.25	6	7A	196.25	10	11	224.25
3	4	175.25	7	8	203.25			

Table D-17: VHF South Africa channel table

Rec No.	Chan No.	Freq (MHz)	Rec No.	Chan No.	Freq (MHz)	Rec No.	Chan No.	Freq (MHz)
0	4	175.25	3	7	199.25	6	10	223.25
1	5	183.25	4	8	207.25	7	11	231.25
2	6	191.25	5	9	215.25	8	13	247.43

Table D-18: VHF OIRT channel table

Rec No.	Chan No.	Freq (MHz)	Rec No.	Chan No.	Freq (MHz)	Rec No.	Chan No.	Freq (MHz)
0	1	49.75	4	5	93.25	8	9	199.25
1	2	59.25	5	6	175.25	9	10	207.25
2	3	77.25	6	7A	183.25	10	11	215.25
3	4	85.25	7	8	191.25	11	112	223.25

Table D-19: VHF CCIR channel table

Rec No.	Chan No.	Freq (MHz)	Rec No.	Chan No.	Freq (MHz)	Rec No.	Chan No.	Freq (MHz)
0	2	48.25	4	6	182.25	8	10	210.25
1	3	55.25	5	7	189.25	9	11	217.25
2	4	62.25	6	8A	196.25	10	12	224.25
3	5	175.25	7	9	203.25			

Appendix E: Factory Default Settings

This section lists the factory default settings for user definable settings. All programs (presets) are set the same, so only the default setting for one program is shown.

Table E-1: Program default settings

Program item	NTSC system	PAL system
Frequency Table	Broadcast	UHF Europa
Channel Number	38	39
Frequency	615.25 MHz	615.25 MHz
ZCP State	Off	Off
ZCP Line Number	16 (F1)	13
ZCP Position	1	1
Audio Preference	BTSC	NICAM
AFC State	Off	Off
Sound Trap State	On	On
Audio Output Mode	Stereo	Stereo
BTSC Stereo Noise	8	-
BTSC SAP Noise	8	-

Table E-2: System default settings

Item	Default setting
Active Program	1
Position Message (IDN command)	Set to ASCII space character
Manual Frequency Response (All frequency steps)	0
User Defined Channel Table (All channels)	200.00 MHz
Serial Mode	RS232
Unit Address	32
RS232 Handshake Status	Enabled
RS485 Termination	Terminated



Glossary

Glossary

Bandwidth

The range of frequencies over which signal amplitude remains constant (within some limit) as it is passed through a system.

Baseband

The composite video signal before it modulates the picture carrier. Composite video that is distributed throughout a studio and is used for recording is at baseband.

Broad Pulses

The vertical synchronizing pulses in the center of the vertical interval. These pulses are long enough to be distinguished from all others and are the part of the signal actually detected by vertical sync separators.

Burst

A small reference packet of the subcarrier sine wave sent on every line of video. Since the carrier is suppressed, this phase and frequency reference is required for synchronous demodulation of the color difference signals in the receiver.

B-Y

One of the color difference signals used in the NTSC and PAL systems. It is obtained by subtracting luminance (Y) from the blue camera signal (B).

Chrominance

The color information in a television picture.

Chrominance Signal

The high-frequency portion of the video signal, that is obtained by quadrature amplitude modulation of a 4.43 MHz (PAL) or 3.58 MHz (NTSC) subcarrier with R-Y and B-Y information.

Composite Video

A single video signal containing all of the necessary information to reproduce a color picture.

CW

Continuous Wave. A separate subcarrier sine wave used for synchronization of chrominance information.

dB (Decibel)

A logarithmic unit used to describe signal ratios. For voltages,
 $dB = 20 \text{ Log}_{10} (V_1/V_2)$.

Demodulator

In general, any device that recovers the original signal after it has modulated a high frequency carrier. In television, it refers to one of the following descriptions:

1. An instrument, such as the Tektronix DS1001, which takes video in its transmitted form (modulated onto the picture carrier) and converts it to baseband.
2. The circuits that recover R-Y and B-Y from the composite signal.

Field

Half of the video lines required to produce a full video frame. In interlaced scan systems, such as NTSC and PAL, the information for one video frame is divided into two fields. Two vertical scans overlay the two fields to produce the complete frame. In the complete frame, adjacent video lines in the picture are from alternate fields.

FM

Frequency Modulation. The process by which the frequency of a carrier signal is varied in proportion to the modulating signal, such as an audio signal. In the NTSC and PAL television systems, audio information is transmitted using FM.

Frame

Contains all the information required for a complete picture. For interlaced scan systems, there are two fields in a frame.

Harmonic Distortion

Signal distortion caused by non-linearities in a system. System non-linearities produce multiples of a single frequency signal applied to the the system. Harmonic distortion is evident when a pure sine wave applied to a system produces harmonic content at multiples of the sine wave frequency at the output.

Hum

The undesirable coupling of the 50 Hz (PAL) or 60 Hz (NTSC) power sine wave into other electrical circuits.

Intercarrier Sound

A method used to recover audio information. Sound is separated from video by beating the sound carrier against the video carrier, producing a 4.5 MHz (NTSC) or 5.5 MHz (PAL) IF that contains the sound information.

IRE

A unit equal to 1/140 of the peak-to-peak amplitude of the video signal, which is typically one volt. The 0 IRE point is at the blanking level, with the sync tip at -40 IRE and the white extending to +100 IRE. IRE stands for Institute of Radio Engineers, the organization that defined the unit.

Linear Distortion

Distortions that are independent of signal amplitude.

Luminance

The signal (Y) that represents brightness, or the amount of light in the picture. This is the only signal required for black and white pictures. For color systems, it is obtained as a weighted sum ($Y = 0.3R + 0.59G + 0.11B$) of the R, G, and B signals.

Modulated

When referring to television test signals, this term implies that chrominance information is present. (For example, a modulated ramp has subcarrier on each step.)

Modulation

A process that moves information around in the frequency domain in order to facilitate transmission or frequency-domain multiplexing.

Non-Linear Distortion

Signal distortion that does not increase at the same rate as the signal amplitude.

NTSC

National Television System Committee. The organization that developed the television standard currently in use in the United

States, Canada, and Japan. Now, NTSC is generally used to refer to that standard.

PAL

Phase Alternate Line. One of the television systems used in Europe and many other parts of the world. The phase of one of the color difference signals alternates from line to line to help cancel out phase errors.

Quadrature AM

A process that allows two signals to modulate a single carrier frequency. Two signals amplitude modulate carrier signals with the same frequency but with a phase difference of 90 degrees (hence the term Quadrature). The two resultant signals are added together before transmission. Both signals are recovered at the receiver by demodulating them 90 degrees apart.

Quadrature Distortion

Distortion resulting from the asymmetry of sidebands used in vestigial sideband television transmission. Quadrature distortion appears when using envelope detection but can be eliminated by using a synchronous demodulator.

RF

Radio Frequency. In television applications, the television signal after the picture carrier modulation process.

RGB

Red, Green and Blue. The three primary colors used in color television's additive color reproduction system. These are the three color components generated by the camera and used by the picture monitor to produce a picture.

Subcarrier

The high-frequency signal used for quadrature amplitude modulation of the color difference signals. The subcarrier frequency is 3,579,545 Hz (NTSC) or 4,433,618.75 Hz (PAL).

Synchronous Detection

A demodulation process in which the original signal is recovered by multiplying the modulated signal with the output of a synchronous oscillator locked to the carrier.

Termination

An impedance at the end of a transmission line that matches the impedance of the source and of the line itself. Proper termination prevents amplitude errors and reflections. Video systems use 75 Ω transmission lines, so a 75 Ω terminator must be at the end of any signal path. A receiving device connected to the transmission line may provide the necessary termination.

Vertical Interval

The synchronizing information that appears between fields and tells the picture monitor to go back to the top of the screen to begin another vertical scan.

Y

Abbreviation for luminance.

Zero Carrier Reference Pulse (ZCP)

A pulse in the vertical interval which is produced by the demodulator to provide a reference for evaluating the depth of modulation.



Index

Index

A

- Accessories
 - optional, 1–3
 - standard, 1–3
- Address
 - RS485 addresses, B–3
 - setting for RS485 serial communication, 3–8
- Adjust, frequency response, 3–10
- AFC
 - remote command, B–13
 - selecting mode in program, 3–6
- Applying power, 1–4, 2–4
- AUD_OUT, remote command, B–14
- AUD_PREF, remote command, B–15
- Audio
 - AUD_OUT remote command, B–14
 - AUD_PREF remote command, B–15
 - BTSC remote command, B–16
 - CHANNEL remote command, B–17
 - input selection, 3–6
 - selecting mode in program, 3–6
 - setting noise threshold, 3–7
 - specifications, A–3
- Audio outputs
 - description, 2–4
 - left, 2–4
 - status display, 2–6

B

- Baud rate, B–2

BTSC

- audio selection for NTSC, 3–6
- remote command, B–16

Buttons

- arrow, 2–2
- CONFIG, 2–2
- DISPLAY, 2–2
- enter, 2–2
- left and right, 2–2
- PROGRAM, 2–2
- up and down, 2–2
- use in Configure menu, 3–2

C

- Certifications and compliances, A–5
- CHANNEL, remote command, B–17
- Channel
 - adjusting current program, 2–9
 - assignments in frequency tables, 3–4
 - list of frequency tables, D–1
 - selecting in program, 3–4
- Channel table, configuring, 3–13
- Channel tables, D–1
 - broadcast, D–12
 - CATV HRC, D–2
 - CATV IRC, D–3
 - CATV standard, D–5
 - HRC, D–10
 - IRC, D–9
 - standard, D–7
 - UHF China, D–14
 - UHF Europa, D–13
 - VHF Australia, D–16
 - VHF CCIR, D–18

- VHF China, D-17
- VHF Europa, D-15
- VHF France, D-16
- VHF Ireland, D-17
- VHF Italy, D-16
- VHF New Zealand, D-17
- VHF OIRT, D-18
- VHF South Africa, D-18
- Cleaning, the exterior surface, C-2
- Commands, B-13
 - AFC, B-13
 - AUD_OUT, B-14
 - AUD_PREF, B-15
 - BTSC, B-16
 - CHANNEL, B-17
 - DISC, B-18
 - FREQ, B-19
 - IDN, B-20
 - LOG, B-21
 - MSG, B-21
 - MSG_C, B-22
 - PATH, B-23
 - PRESET, B-24
 - PWD, B-24
 - RECPRT, B-25
 - REPORT, B-26
 - SETT, B-26
 - STRAP, B-28
 - syntax defined, B-11
 - TUNING, B-29
 - ZCP, B-30
- Communication
 - serial port, 2-3
 - serial port pin out, B-1
 - serial port protocol, B-1
- Composite output, description, 2-4
- Configure
 - AFC mode, 3-6
 - audio noise threshold, 3-7
 - BTSC stereo and SAP noise thresholds, 3-7

- channel table, 3-13
- display contrast, 3-12
- frequency response, 3-10
- frequency table, 3-3
- menu hierarchy, 3-1
- operation, 3-1
- overview of Configure menu, 3-1
- programs, 3-3
- quick guide, 3-2
- RS232 handshaking, 3-9
- RS485 address, 3-8
- RS485 termination, 3-9
- selecting a channel, 3-4
- selecting Audio mode, 3-6
- selecting display modes, 2-5
- selecting frequency, 3-4
- selecting from menu, 3-2
- selecting ZCP, 3-5
- serial mode, 3-8
- serial port, 3-8
- sound trap, 3-7
- user defined channel table, 3-13
- Connection
 - serial port pin assignments, B-2
 - to AC power, 1-4
- Connectors, rear panel, 2-3
- Contrast, adjustment, 3-12
- Controls, front panel, 2-1
- Custom channel table, 3-13
- Custom installation, 1-7

D

- Default settings, E-1
- Description, of product, 1-1
- Device address, for RS485 protocol, B-4
- DISC, remote command, B-18
- Display
 - adjusting contrast, 3-12

description, 2–2

Display modes

- audio output status, 2–6
- firmware revision, 2–7
- instrument identification, 2–7
- NICAM error count, 2–6
- program set up, 2–6
- selecting, 2–5
- system status, 2–5
- temperature status, 2–8

E

Electrical installation, 1–4

Electrical specifications, A–4

Environmental characteristics, A–4

F

Factory settings, E–1

Features

- front panel, 2–1
- rear panel, 2–3

Firmware, revision display, 2–7

4.5 MHz output, description, 2–4

FREQ, remote command, B–19

Frequency

- adjusting current program, 2–9
- configuring response, 3–10
- FREQ remote command, B–19
- list of tables, D–1
- selecting a table, 3–3
- selecting in program, 3–4

Front panel

- arrow buttons, 2–2
- CONFIG button, 2–2
- description of features, 2–1
- DISPLAY button, 2–2

- enter button, 2–2
- LCD display, 2–2
- left and right buttons, 2–2
- PROGRAM button, 2–2
- up and down buttons, 2–2

Functional check, 1–8

Fuse

- AC fuse location, 2–3
- replacing, C–2

G

Getting started, 1–1

- electrical installation, 1–4
- functional check, 1–8
- mechanical installation, 1–6
- options, 1–2
- product description, 1–1
- standard accessories, 1–3

I

Identification

- IDN remote command, B–20
- of instrument, 2–7

IDN, remote command, B–20

IF output, description, 2–4

Initialization, at power on, 1–5

Inputs, RF, 2–4

Installation

- custom, 1–7
- electrical, 1–4
- functional check, 1–8
- in a system, 1–6
- mechanical, 1–6
- rackmount information, 1–7
- typical configuration, 1–6

Instrument, firmware revision, 2–7

L

- Local state, DISC remote command, B-18
- LOG, remote command, B-21

M

- Mains source, 1-4
- Maintenance
 - cleaning, C-2
 - replacing the fuse, C-2
- Manual, organization, ix
- Measurements
 - NICAM error count, 2-6
 - RF signal strength, 2-5
- Mechanical installation, 1-6
- MSG, remote command, B-21
- MSG_C, remote command, B-22

N

- NICAM errors, status display, 2-6
- Noise threshold
 - remote command BTSC, B-16
 - selecting mode in program, 3-7
- Nomenclature, location, 1-1

O

- Operating basics, 2-1
- Operating procedures, 2-4
- Optional accessories, rackmount kits, 1-3
- Options, 1-2
- Organization, of manual, ix
- Outputs
 - 4.5 MHz O/P, 2-4
 - audio, 2-4
 - composite, 2-4
 - IF O/P, 2-4
 - Quad O/P, 2-3

P

- Packaging for shipment, C-1
- PATH, remote command, B-23
- Performance requirements, specifications, A-1
- Physical characteristics, A-4
- Pin out, of serial port, B-2
- Polling
 - for system status, B-8
 - PATH remote command, B-23
- Post correction. *See* Sound trap
- Power
 - AC connector, 2-3
 - AC source type, 1-4
 - applying, 2-4
 - cord options, 1-2
 - fuse holder, 2-3
 - power on procedure, 1-4
 - replacing the fuse, C-2
 - self tests at power on, 1-5
 - setting for AC mains, 1-4
- Power cord, optional types, 1-2
- Power requirements, specifications, A-4
- PRESET, remote command, B-24
- Product, description, ix
- Program
 - adjusting current channel, 2-9
 - configuration of programs, 3-3
 - how to select, 2-8
 - navigating in menu, 2-8
 - PRESET remote command, B-24
 - RECPRT remote command, B-25
 - selecting a channel, 3-4
 - selecting a frequency table, 3-3
 - selecting the frequency, 3-4
 - setting the AFC mode, 3-6

- setting the audio mode, 3–6
- setting the noise threshold, 3–7
- setting the sound trap, 3–7
- setting ZCP, 3–5
- status display, 2–6
- Programming
 - command syntax, B–11
 - command types, B–5
 - remote flag, B–4
- Programming model, B–3
- PWD, remote command, B–24

Q

- QUAD output, description, 2–3

R

- Rackmounting, 1–7
 - available kits, 1–7
- Rear panel, description of features, 2–3
- RECPRT, remote command, B–25
- Reference section, 3–1
- Remote address, for RS485 protocol, B–4
- Remote control, B–1
 - command descriptions, B–13
 - command syntax, B–11
 - command types, B–5
 - programming model, B–3
 - remote flag, B–4
 - sending and receiving data, B–5
- Remote flag
 - DISC remote command, B–18
 - RS485 protocol, B–4
- Remote operation flag, RS485 protocol, B–4
- Replacing the fuse, C–2
- REPORT, remote command, B–26

- RF input
 - description, 2–4
 - signal strength, 2–5
- RS232
 - configuring, 3–8
 - handshaking, 3–9
 - protocol settings, B–2
- RS485
 - configuring, 3–8
 - device address, B–4
 - remote address, B–4
 - setting address, 3–8
 - special byte codes, B–3
 - termination, 3–9

S

- Safety certification and compliance, A–6
- Safety standards, A–7
- SCL protocol, B–3
- Self tests, at power on, 1–5
- Sending and receiving data, B–5
- Serial
 - addresses for RS485, B–3
 - baud rate, B–2
 - command descriptions, B–13
 - command syntax, B–11
 - command types, B–5
 - configuring the port, 3–8
 - pin assignments for port, B–2
 - port connections, B–1
 - port protocol, B–2
 - programming model, B–3
 - rear panel connector, 2–3
 - remote flag for RS485, B–4
 - RS232 handshaking, 3–9
 - RS485 special byte codes, B–3
 - RTS/CTS handshaking, 3–9
 - selecting the mode, 3–8

- selecting the port protocol, 3–8
- sending and receiving data, B–5
- setting the port address for RS485, 3–8
- setting unit address for RS485, 3–8
- termination for RS485, 3–9
- Serial number, location, 1–1
- Set up. *See* Installation
- SETT, remote command, B–26
- Settings, default, E–1
- Shipping information, C–1
- Signal strength, measuring, 2–5
- Sound trap, selecting mode in program, 3–7
- Specifications, A–1
 - audio, A–3
 - certifications and compliances, A–5
 - environmental characteristics, A–4
- System status, displaying, 2–5

T

- Temperature, operational status, 2–8

- Termination, for RS485 serial communication, 3–9
- TUNING, remote command, B–29

V

- Version number, location, 1–1
- Video, specifications, A–2
- Video outputs
 - 4.5 MHz O/P, 2–4
 - composite, 2–4
 - IF O/P, 2–4
 - quadrature, 2–3

Z

- ZCP
 - remote command, B–30
 - selecting in program, 3–5
- Zero carrier pulse, setting in program, 3–5



Artisan Technology Group is your source for quality new and certified-used/pre-owned equipment

- FAST SHIPPING AND DELIVERY
- TENS OF THOUSANDS OF IN-STOCK ITEMS
- EQUIPMENT DEMOS
- HUNDREDS OF MANUFACTURERS SUPPORTED
- LEASING/MONTHLY RENTALS
- ITAR CERTIFIED SECURE ASSET SOLUTIONS

SERVICE CENTER REPAIRS

Experienced engineers and technicians on staff at our full-service, in-house repair center

*InstraView*SM REMOTE INSPECTION

Remotely inspect equipment before purchasing with our interactive website at www.instraview.com ↗

WE BUY USED EQUIPMENT

Sell your excess, underutilized, and idle used equipment. We also offer credit for buy-backs and trade-ins. www.artisanng.com/WeBuyEquipment ↗

LOOKING FOR MORE INFORMATION?

Visit us on the web at www.artisanng.com ↗ for more information on price quotations, drivers, technical specifications, manuals, and documentation

Contact us: (888) 88-SOURCE | sales@artisanng.com | www.artisanng.com