



## Artisan Technology Group is your source for quality new and certified-used/pre-owned equipment

- FAST SHIPPING AND DELIVERY
- TENS OF THOUSANDS OF IN-STOCK ITEMS
- EQUIPMENT DEMOS
- HUNDREDS OF MANUFACTURERS SUPPORTED
- LEASING/MONTHLY RENTALS
- ITAR CERTIFIED SECURE ASSET SOLUTIONS

### SERVICE CENTER REPAIRS

Experienced engineers and technicians on staff at our full-service, in-house repair center

### *InstraView*<sup>SM</sup> REMOTE INSPECTION

Remotely inspect equipment before purchasing with our interactive website at [www.instraview.com](http://www.instraview.com) ↗

### WE BUY USED EQUIPMENT

Sell your excess, underutilized, and idle used equipment. We also offer credit for buy-backs and trade-ins. [www.artisanng.com/WeBuyEquipment](http://www.artisanng.com/WeBuyEquipment) ↗

### LOOKING FOR MORE INFORMATION?

Visit us on the web at [www.artisanng.com](http://www.artisanng.com) ↗ for more information on price quotations, drivers, technical specifications, manuals, and documentation

**Contact us:** (888) 88-SOURCE | [sales@artisanng.com](mailto:sales@artisanng.com) | [www.artisanng.com](http://www.artisanng.com)



## **ALTIVAR™ 16 AC Drive Catalog**



Introduction	2-3
Specifications	
Environment	4
Electrical Characteristics	4-5
Torque Characteristics	6
Motor Thermal Overload Protection	6
Special Applications	6
Drive Selection	7
Accessories and Options	
Dynamic Braking	8
RFI Filters	9
Inductors	9
Display Options	10-11
Option Cards for Specific Applications	11
Dimensions	12
Wiring Diagrams	13
Option Selection Guide	14-15
Configuration and Adjustment of Parameters	16-18
Description of Option Cards	19
Option Card Functions	
Analog Input Parameters	20
Logic Input Assignment	21-25
Logic Output Assignment	26-27
Specific Functions	28-29
Catalog Numbers	30-31



---

## Introduction

---

The Altivar 16 AC drive for three-phase asynchronous squirrel cage motors incorporates the latest technology:

- Surface mount technology
- 16-bit microprocessor
- ASIC circuit
- IPM power module

With its compact design and conformity to international standards, the Altivar 16 is a global product. A complete offering of options and accessories allows the Altivar 16 to meet all types of applications.

---

## Factory setting of base drive

---

The Altivar 16 is factory-set to provide:

- Transient overtorque necessary for starting
  - Maximum available torque at low speeds with no adjustment required (from 5 to 50/60 Hz)
  - Automatic adjustment of acceleration and deceleration ramp times when the torque capabilities are exceeded
- 

## Reduction of motor noise

---

In the Altivar 16, a high switching frequency (5 kHz, or 10 kHz for certain applications) produces a waveform with few harmonics.

This switching frequency is randomly modulated to  $\pm 1$  kHz, reducing motor noise and limiting losses in the drive.

---

## Use in industrial applications

---

### RFI filters

The use of RFI filters (1) prevents radio frequency emissions from interfering with nearby antennas or conductors such as radios or televisions.

Each RFI filter kit contains in a single package:

- One filter module for the input of the drive allowing the Altivar 16 to conform to VDE871, CISPR11 and EN50011 regarding the limitation of radio frequency interference in the conduction mode
  - One filter module for the output of the drive to limit interference from motor cables, ground leakage current and overvoltage at motor connections
- 

### Inductors

The use of inductors on the input allows the Altivar 16 to run when supplied by lines with very low impedance or lines subject to interference from other input loads.

The use of inductors between drive and motor is recommended under certain conditions, such as when connections between drive and motor are very long, or when running several motors in parallel.

---

## Dynamic braking

---

The dissipation of excess braking energy in an exterior resistor allows the Altivar 16 to function in quadrants 2 and 4 of the speed/torque curve.

### Applications:

- Machines with high inertia
  - Overhauling loads
  - Machines with fast cycles
-

---

## Configuring the Altivar 16 for the application

---

Three option cards are available for customizing the Altivar 16 to the following applications (2):

- Material handling or general use
- Pumps and fans
- Textile or wood industry (high speed motors)

Each option card provides parameters specific to its application as well as additional inputs and outputs.

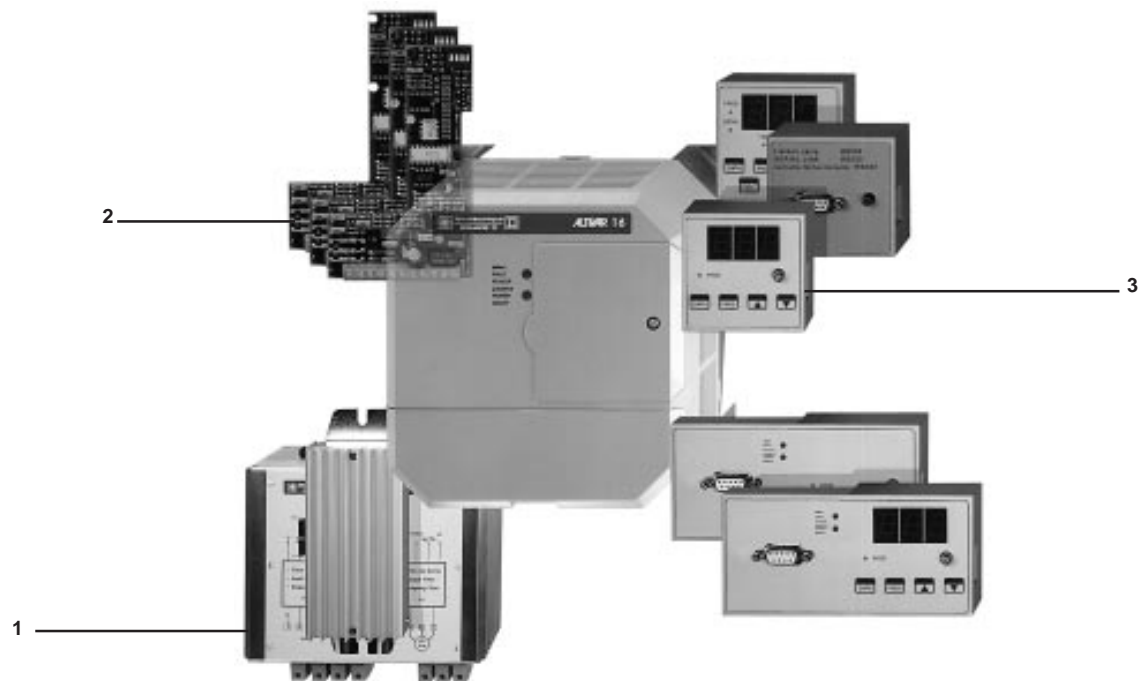

- 1 RFI filters
- 2 Option cards
- 3 Display/adjustment options

---

## Dialog and communication

---

Three display/adjustment options (3) are available for monitoring and changing Altivar 16 parameters. These allow local or remote dialog, or connection to a personal computer.

The display/adjustment options allow the parameters of the Altivar 16 to be changed so that its configuration is suited to the application.

The options also aid in troubleshooting in the event of a fault by displaying the fault code.

The PC connection option allows parameter settings to be saved on a diskette or hard disk for downloading into other drives.

# Altivar 16 AC Drive Specifications



## Environment

<b>Standards</b>		UL, CSA, IEC, VDE, CE
<b>Degree of protection</b>		NEMA 1, IP30 IP30 without the top plate mounted
<b>Resistance to vibration and shocks</b>		Conforming to IEC 68-2-6: - 2 mm peak to peak from 5 to 16 Hz - 1 g peak up to 150 Hz
<b>Maximum ambient pollution</b>		Pollution degree 2 according to IEC 664
<b>Maximum relative humidity</b>		93 % non-condensing without dripping
<b>Temperature</b>	Storage	°F (°C) - 13 to +158 (-25 to +70)
	Operation	°F (°C) +32 to +104 (0 to +40) with NEMA 1
		°F (°C) +32 to +122 (0 to +50) with IP30
<b>Maximum altitude</b>	<b>ft (m)</b>	3300 (1000) without derating
		Derate by 3 % for each additional 3300 ft (1000 m)

## Electrical characteristics

Altivar ATV16		U09M2	U18M2	U29M2	U41M2	U18N4	U29N4	U41N4	U54N4	U72N4
<b>Total dissipated power at rated load</b>	<b>W</b>	22	35	55	65	35	50	70	100	135
<b>Input</b>	Voltage	<b>V</b> 208 - 10 % to 240 + 10 %				400 - 15 % to 460 + 15 %				
	Frequency	<b>Hz</b> 50/60 ± 2				50/60 ± 2				
<b>Output voltage</b>		Maximum voltage equal to input voltage								
<b>Output frequency range</b>	<b>Hz</b>	0.1 to 50/60								
	<b>Hz</b>	0.1 to 200/400 with option								
<b>Transient overtorque</b>		150 % of rated motor torque (typical value)								
<b>Starting torque</b>		200 % of rated motor torque for 0.2 s								
<b>Braking torque</b>		30 % of nominal motor torque (typical value) Up to 150 % with option								





## Electrical characteristics (continued)

<b>Available control voltage</b>	0 V common + 10 V for manual speed potentiometer (1k $\Omega$ to 10 k $\Omega$ ); maximum output current = 10 mA + 24 V for control inputs, maximum output current = 60 mA	
<b>Reference speed</b>	- 1 voltage analog input: 0-10 V, impedance = 30 k $\Omega$ - 1 current analog input: 0-20 mA or 4-20 mA, impedance = 250 $\Omega$ - With option, 1 additional voltage analog input: $\pm$ 10 V	
<b>Frequency resolution</b>	- Analog reference: 0.05 Hz for 50 Hz, 0.06 Hz for 60 Hz - Digital reference with option: 0.015 Hz for 50 Hz, 0.018 Hz for 60 Hz	
<b>Reference response time</b>	5 to 10 ms	
<b>Rotation direction command</b>	2 logic inputs, impedance = 1.5 k $\Omega$ Supply +24 V (maximum 30 V), 0 state if < 5 V, 1 state if > 11 V	
<b>Acceleration and deceleration ramps</b>	Factory set to 3 s, individually adjustable from 0.1 s to 600 s with option Ramp times automatically adjusted in the case of overtorque Deceleration ramp adaptation can be disabled with option	
<b>Low speed/high speed limits</b>	Factory set at 0 and 50/60 Hz Adjustable up to 200/400 Hz with option	
<b>Voltage/frequency ratio</b>	Factory set for the majority of constant torque applications Adjustable with option: specific laws for machines requiring high torque at low speed, pumps and fans, or high speed applications	
<b>Frequency loop gain</b>	Factory set for the majority of applications Adjustable with options for machines with high resistant torque or inertia, or for machines with fast cycles	
<b>Slip compensation</b>	Automatic Can be disabled or adjusted with option	
<b>Braking to standstill</b>	Automatic by DC injection for 0.5 s when frequency drops below 0.1 Hz (0.7 times the permanent output current of the drive) Adjustable with option	
<b>Drive protection</b>	Protection against short circuits: - Internal power supplies - Between output phases U/T1, V/T2, W/T3 - Between output phase and ground	Thermal protection against input line supply Protection against input line supply under/overvoltage Protection against phase loss: ATV16U••N4 only
<b>Motor protection</b>	Incorporated electronic thermal protection by I <sup>2</sup> t calculation (see page 6)	
<b>Fault relay</b> (fault information output)	1 N.O. contact Minimum: 10 mA at 24 Vdc Maximum resistive load: 5 A at 250 VAC or 30 Vdc Maximum inductive load: 1.5 A at 250 VAC or 2.5 A at 30 Vdc	
<b>Display</b>	2 LEDs on front of drive: - Red LED indicates fault - Green LED indicates drive supply on  Display of codes with three 7-segment display possible with option	



### Torque Characteristics (typical curves)

The curves below show the continuous torque and transient overtorque capabilities both with a self-ventilated motor and with a force-ventilated motor. The difference is in the ability of the force-ventilated motor to supply torque below half speed without danger of motor overheating.

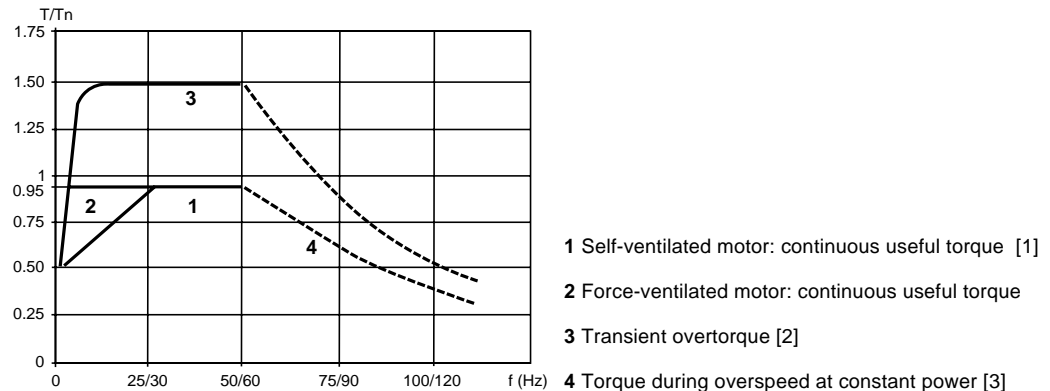

- [1] For fractional powers  $\leq 1/3$  hp (250 W), the derating is less (20 % instead of 50 % at the lowest frequency).  
 [2] Overtorque is limited to 110% Tn with the variable torque or high speed motor option cards.  
 [3] With one of the display/adjustment options, the nominal motor frequency and the maximum output frequency can be adjusted from 40 to 200 Hz (see page 16).

**Caution:** consult motor manufacturer before operating motor above rated speed.

**Note:** The maximum output frequency can be adjusted up to 400 Hz for use with a special motor by using the high speed motor option card and one of the display/adjustment options.

### Motor Thermal Overload Protection

By continuously calculating  $I^2t$  (I being the current to the motor), thermal overload protection of the motor is insured in the following conditions:

- Ambient motor temperature  $\leq +104$  °F (+40°C)
- Frequency range is between 25/30 Hz and 50/60 Hz with a self-ventilated motor
- Nominal motor current = 0.9 times the continuous output current of the drive (factory preset). If the nominal motor current is different, use one of the display/adjustment options.

If the ambient motor temperature exceeds 104°F (40° C), or if a self-ventilated motor is run at low speed, external thermal overload protection should be provided.

### Special Applications

- When motor power is different from drive rated power, it is permissible for motor power to be less than or equal to drive rated power. When motor power is slightly higher than drive rated power, insure that the motor current is not higher than the continuous drive output current.
- Motors in parallel:  
Drive rated power must be greater than or equal to the sum of the powers of the motors connected to the drive. In this case, it is necessary to provide separate overload protection by thermal sensor or relay. If there are three or more motors in parallel, installation of a three-phase inductor between the drive controller and the motor is recommended.
- Connection of an additional motor downstream from the drive:  
Motor can be connected downstream while drive is running if the power of the motor is less than that of the drive, and if the overload is acceptable (peak current is less than or equal to the maximum transient drive current).
- Use with special motors:
  - Brake motor or tapered rotor motor: may be used.
  - Synchronous reluctance motor: slip compensation must be overridden with one of the display/adjustment options.
  - Motor with a nominal frequency other than 50/60 Hz: use the display/adjustment option to adjust the nominal motor frequency.





ATV16U09M2



ATV16U18N4



ATV16U72N4

Drives with frequency range from 0.1 Hz to 50/60 Hz (200/400 Hz with option)

Supply Input Voltage V	Line current [1]		Motor Rated Power kW hp		Altivar 16 Continuous Output Current A			Power kVA	Catalog Numbers	Weight lbs (kg)
	Single Phase A	Three Phase A				Maximum Transient Current [2] A				
208/240 50/60 Hz Single-phase	4	–	0.37	0.5	2.1	3.2	0.9	<b>ATV16U09M2</b> [3]	3.97 (1.80)	
	7	–	0.75	1	4	5.4	1.8	<b>ATV16U18M2</b> [3]	4.08 (1.85)	
208/240 50/60 Hz Single or Three-phase	14	10	1.5	2	7.1	10	2.9	<b>ATV16U29M2</b> [3]	7.28 (3.30)	
	18	14	2.2	3	10.0	14	4.1	<b>ATV16U41M2</b> [3]	9.48 (4.30)	
400/460 50/60 Hz Three-phase	–	3.3	0.75	1	2.3	3.1	1.8	<b>ATV16U18N4</b> [3]	7.50 (3.40)	
	–	6	1.5	2	4.1	5.5	2.9	<b>ATV16U29N4</b> [3]	7.50 (3.40)	
	–	9	2.2	3	5.8	7.9	4.1	<b>ATV16U41N4</b> [3]	9.70 (4.40)	
	–	12	3	4	7.8	11	5.4	<b>ATV16U54N4</b> [3]	9.70 (4.40)	
	–	16	4	5	10.5	14.2	7.2	<b>ATV16U72N4</b> [3]	11.02 (5.00)	

[1] Typical value without additional inductance

[2] For 60 seconds

[3] This number indicates a drive without a user's manual. Add a letter at the end of the part number to obtain a user's manual in the following languages:

- U = English (United States)
- E = English (United Kingdom)
- F = French
- G = German
- S = Spanish

**Note:** In the reference column, the two numbers following the first U correspond to drive power, not to motor power.



## Dynamic braking

Dynamic braking allows the Altivar 16 to function in quadrants 2 and 4 of the speed/torque curve and dissipates excess braking energy in an external resistor.

**Applications:** machines with high inertia, overhauling loads and machines with fast cycles.

The braking module is integrated in the Altivar 16 except for ATV16U09M2 and ATV16U18M2.



VW3A16601

Description	Resistance Value $\Omega$	Continuous Power Rating per Resistor [1] W	For Drives	Catalog Numbers	Weight lbs (kg)
Braking Module	–	–	ATV16U09M2 ATV16U18M2	<b>VW3A16601</b>	0.55 (0.25)
Braking Resistors (R)	100	50	ATV16U09M2 ATV16U18M2	<b>VW3A16705</b>	1.50 (0.68)
	100	50	ATV16U29M2 ATV16U18N4 ATV16U29N4 ATV16U41N4	<b>VW3A16705</b>	1.50 (0.68)
	50	50	ATV16U41M2	<b>VW3A16705</b>	1.50 (0.68)
	100	50	ATV16U54N4 ATV16U72N4	<b>VW3A16705</b>	1.50 (0.68)

[1] Power rating per resistor is calculated based on fuse current. Actual power rating is 135 W.

### Dynamic braking torque

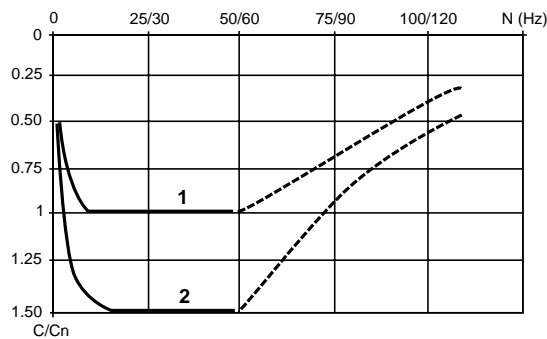

- 1 Continuous braking torque (overhauling load)
- 2 Maximum transient braking torque

Whenever the frequency goes below 5 Hz, braking torque decreases rapidly. Slip compensation is disabled when the motor is regenerating.

For demanding applications (overhauling loads, hoisting) it is necessary to calculate the value of the resistor. Consult your local sales office.

The minimum resistance value is 50  $\Omega$  (no matter what the rating of the Altivar 16).

**Description:** The braking resistor kit contains two 50  $\Omega$  type PX1 resistors and is supplied with a 1A fuse which is a Gould Shawmut TRSIR. The kit does not include an enclosure.



VW3A16406



ATV16U18N4  
+  
VW3A16406  
+  
VW3A16409

## Radio frequency interference (RFI) filters

The use of RFI filters prevents radio frequency emissions from interfering with nearby antennas or conductors such as radios or televisions.

For Drives	Characteristics [1]	Catalog Numbers	Weight lbs (kg)
ATV16U09M2, 16U18M2	208/240 V: 8 and 4 A	<b>VW3A16401</b>	6.17 (2.80)
ATV16U29M2 (single-phase input)	208/240 V: 14 and 7.1 A	<b>VW3A16402</b>	7.72 (3.50)
ATV16U29M2 (three-phase input) ATV16U41N4, 16U54N4	400/460 V: 11.7 and 7.8 A	<b>VW3A16403</b>	11.24 (5.10)
ATV16U41M2 (single-phase input)	208/240 V: 20 and 10 A	<b>VW3A16404</b>	8.82 (4.00)
ATV16U41M2 (three-phase input)	208/240 V: 15 and 10 A	<b>VW3A16405</b>	13.01 (5.90)
ATV16U18N4, 16U29N4	400/460 V: 6.2 and 4.1 A	<b>VW3A16406</b>	10.14 (4.60)
ATV16U72N4	400/460 V: 15.8 and 10.5 A	<b>VW3A16407</b>	13.01 (5.90)

[1] Voltage and current for input and output filters.

**Description:** RFI filter kits are IP20. The package consists of:

- One filter module for the input of the drive allowing the Altivar to conform to VDE 871, CISPR11 and EN 50011 regarding the limitation of radio frequency interference in conduction mode.
- One filter module for the output of the drive to limit interference from motor cables, ground leakage currents, and overvoltages at the motor connections if the cables are very long.

## Inductors

Inductors protect against input line overvoltage and reduce the current absorbed by the drive. When used between the drive and the motor, inductors limit ground leakage interference currents.

For Drives	Characteristics	Catalog Numbers	Weight lbs (kg)
ATV16U09M2, 16U18M2	5 mH - 6 A single-phase	<b>VW3A16501</b>	4.41 (2.00)
ATV16U29M2, 16U41M2 (single-phase)	2 mH - 16 A single-phase	<b>VW3A16502</b>	6.39 (2.90)
ATV16U29M2, 16U41M2 (three-phase) ATV16U54N4, 16U72N4	1.7 mH - 11 A three-phase	<b>VW3A16503</b>	9.92 (4.50)
ATV16U18N4, 16U29N4, 16U41N4	5 mH - 6 A three-phase	<b>VW3A16504</b>	6.83 (3.10)

**Description:** Inductor kits are IP20.

**Recommendations for use:**

- Recommendations for use of line inductors:
  - Input lines subject to interference from other loads
  - Drive controller supplied by a line with very low impedance
  - Large number of drive controllers installed on the same line
- Recommendations for use of inductors between drive & motor:
  - Wire connecting drive and motor is very long
  - 3 or more motors are controlled in parallel
  - Motor has more than 6 poles and a high power factor with low stator inductance

## Mounting kit for Altivar 16 with filters

Description	For Drives	Catalog Numbers	Weight lbs (kg)
2 mounting rails AM1ED041 with AF1CG5 nuts	ATV16U09M2, 16U18M2	<b>VW3A16408</b>	1.87 (0.85)
2 mounting rails AM1ED051 with AF1CG5 nuts	ATV16U29M2 to 16U72N4	<b>VW3A16409</b>	2.21 (1.00)



# Altivar 16 AC Drive

## Display and adjustment of parameters



VW3A16101



VW3A16102



VW3A16104



ATV16U09M2  
+  
VW3A16101



ATV16U09M2  
+  
VW3A16104

### Display Options

Three display /adjustment options are available for monitoring and changing Altivar 16 parameters. These allow local or remote dialog, or connection to a personal computer.

Description	For Drive	Catalog Numbers	Weight lbs (kg)
Display/adjustment [1]	ATV16 all ranges	<b>VW3A16101</b> [4]	0.55 (0.25)
Display/adjustment/ local control [1]	ATV16 all ranges	<b>VW3A16102</b> [4]	0.55 (0.25)
Kit for remote mounting of the display/adjustment options [2]	ATV16 all ranges	<b>VW3A16103</b>	1.10 (0.50)
Connection to PC [3]	ATV16 all ranges	<b>VW3A16104</b>	1.10 (0.50)

[1] Keypad mounts on front of drive. To mount remotely, order kit **VW3A16103** also.

[2] Kit is comprised of an interface box which mounts to front of drive, a 3 meter cable and a plastic keypad cover.

[3] Kit is comprised of an interface box which mounts to the front of the drive, a 3-1/2" software disk, a 3 meter 9-pin to 9-pin cable, and a 9-pin to 25-pin adaptor.

[4] This number indicates an option without a user's manual. Add a letter at the end of the part number to obtain a user's manual in the following languages: **U**= English (United States), **E**= English (U K), **F**=French, **G**=German, **S**=(Spanish).

### Description of the display option [5]

The **VW3A16101** has 4 keys, 1 LED and three 7-segment displays. A switch on the back allows selection of the adjustment mode or operation mode (indicated by the LED). In the operation mode, adjustment of parameters is not possible, only display of electrical quantities, fault codes and parameter values.

### Configuration parameters (not displayed during operation)

<i>U n S</i>	Nominal motor voltage (V)
<i>F r S</i>	Nominal motor frequency (Hz)
<i>t F r</i>	Maximum output frequency of drive (Hz)
<i>U F t</i>	Voltage/frequency ratio (L, n or P; factory set to n)
<i>b r A</i>	Deceleration ramp adaptation (yes or no; factory set to yes)
<i>S L P</i>	Slip compensation (yes or no; factory set to yes)

### Adjustment parameters

<i>A c c</i>	Acceleration ramp time (s)
<i>d E c</i>	Deceleration ramp time (s)
<i>L S P</i>	Low speed (Hz)
<i>H S P</i>	High speed (Hz)
<i>U F r</i>	Voltage/frequency ratio adjustment (from 00 to 100, factory set to 20)
<i>F L G</i>	Frequency loop gain (from 00 to 99, factory set to 33)
<i>I t H</i>	Motor thermal protection (A)

### Display of electrical quantities

<i>F r H</i>	Reference frequency (Hz)
<i>L c r</i>	Motor current (A)
<i>U L n</i>	Supply input voltage (V)

[5] See detailed description of functions, pages 16 to 18.





**Fault codes:**

<i>U S F</i>	Undervoltage	<i>O L F</i>	Motor overload
<i>O S F</i>	Overvoltage	<i>d r F</i>	Transient overcurrent, drive overheating
<i>O b F</i>	Overbraking	<i>I n F</i>	Internal fault

**Description of the display/adjustment/local command option**

Similar to the **VW3A16101** option, the **VW3A16102** option allows local control (Start/Stop) and adds:

- 2 keys: Start and Stop/Reset
- 3 LEDs: Local, Forward (FW) and Reverse (RV)

Switch located on the back allows selection of local control.

To start the drive locally with the start push button, a direction command (FW/RV) and a reference signal must be present.

**Description of the connection to PC option**

The **VW3A16104** allows the drive to be connected to a personal computer via RS 232C. The software gives the following advantages:

- Prepare a job in the design office without connecting the drive to the computer
- Save configurations and adjustments on floppy or hard disk and download them into the drive
- Provide a printout of documents for future reference

The software allows access to all the adjustments of the **VW3A16101** display options as well as the supplementary functions of the option card. It also allows the reassignment of the inputs and outputs of the option cards. [1]



**VW3-A16201**

**Option cards for specific applications [1]**

By installing an option card, the Altivar 16 can be adapted to a particular application.

Description	For Drives	Catalog Numbers	Weight lbs (kg)
General use/material handling card	ATV16 all ranges	<b>VW3A16201</b> [2]	0.44 (.20)
Variable torque card (pumps, fans)	ATV16 all ranges	<b>VW3A16202</b> [2]	0.44 (.20)
High speed motor card (textile, wood industry)	ATV16 all ranges	<b>VW3A16203</b> [2]	0.44 (.20)

When first installed, the option card automatically configures the following:

- Output voltage, switching frequency and configuration of the voltage/frequency ratio
- Functions specific to the application
- Associated inputs and outputs

Modification of the configuration and adjustment parameters, especially the specific functions, requires the addition of one of the display/adjustment options.

**Note:** with the **VW3A16102** option, the specific control functions take priority over local control.

[1] See detailed description, pages 14 and 15, and 19-29.

[2] This number indicates an option without a user's manual. Add a letter at the end of the part number to obtain a user's manual in the following languages: **U**=English (United States), **E**= English (United Kingdom), **F**=French, **G** =German, **S** =Spanish.



# Altivar 16 AC Drive Dimensions



## ATV16U●●●●

## Mounting precautions

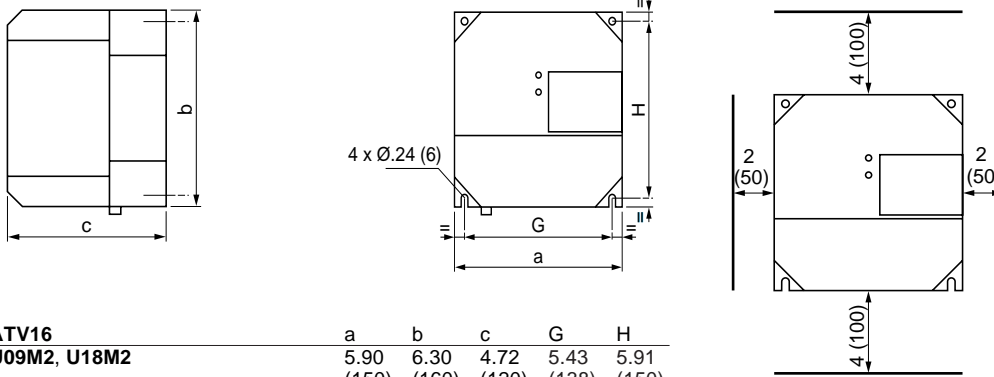

ATV16	a	b	c	G	H
<b>U09M2, U18M2</b>	5.90 (150)	6.30 (160)	4.72 (120)	5.43 (138)	5.91 (150)
<b>U29M2, U18N4, U29N4</b>	7.09 (180)	7.87 (200)	5.67 (144)	6.61 (168)	7.48 (190)
<b>U41M2, U41N4, U54N4, U72N4</b>	7.87 (200)	9.06 (230)	5.98 (152)	7.40 (188)	8.66 (220)

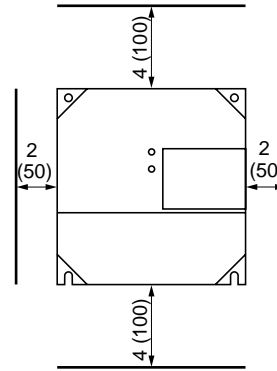

- For ATV16, all drives:
- Leave space around the drive as shown.
  - Mount drive vertically.
  - Avoid placing drive near or above heating elements.

## Brake module VW3A16601 (Mounted on AM1-ED mounting rail)

## Brake resistor VW3A16705

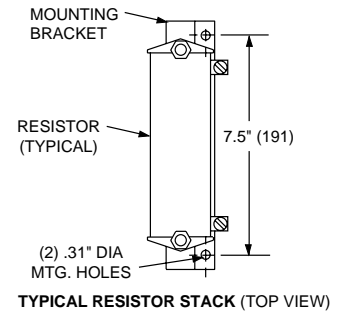
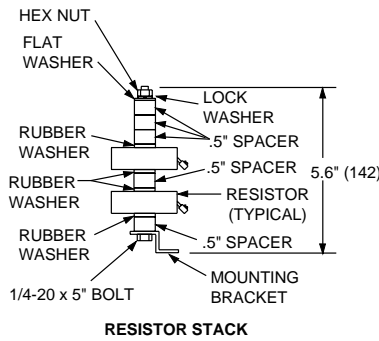
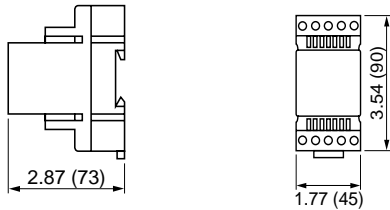

## RFI filters VW3A16401 to VW3A16407

## Inductors VW3A16501 to VW3A16504

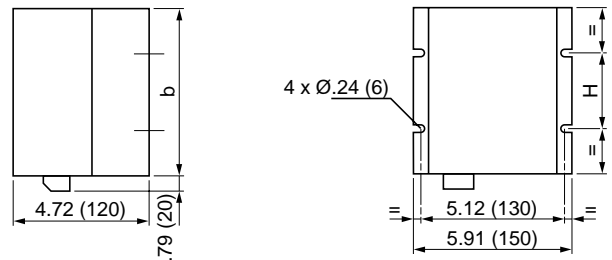
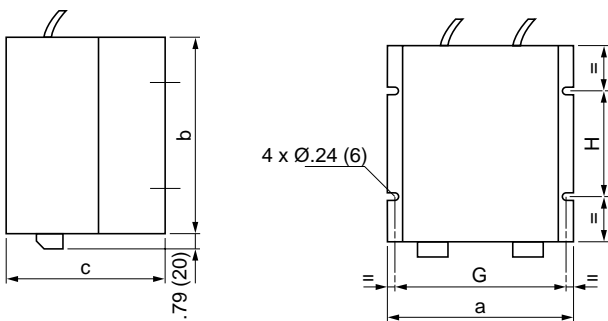

VW3	a	b	c	G	H
<b>A16401</b>	5.90 (150)	4.84 (123)	4.72 (120)	5.12 (130)	3.15 (80)
<b>A16402, A16403, A16406</b>	7.48 (190)	5.63 (143)	5.75 (146)	6.69 (170)	3.94 (100)
<b>A16404, A16405, A16407</b>	7.48 (190)	7.21 (183)	5.75 (146)	6.69 (170)	5.51 (140)

VW3	b	H
<b>A16501, A16502</b>	4.84 (123)	3.15 (80)
<b>A16503, A16504</b>	5.63 (143)	3.15 (80)

Dimensions are given in inches (millimeters).





## ATV16U09M2 and 16U18M2 Wiring of 208/240 V single-phase

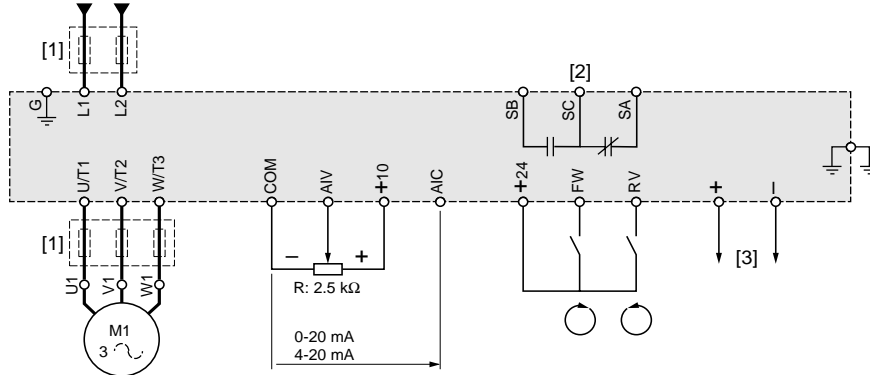

External power supply

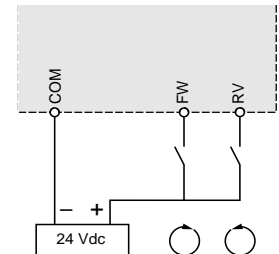

- [1] Possibility of filters and/or inductors.
- [2] Fault relay contacts: use to remotely indicate state of drive.
- [3] Possibility of option **VW3A16601** and brake resistance.

## ATV16U29M2 and 16U41M2 Wiring of 208/240 V single or three-phase

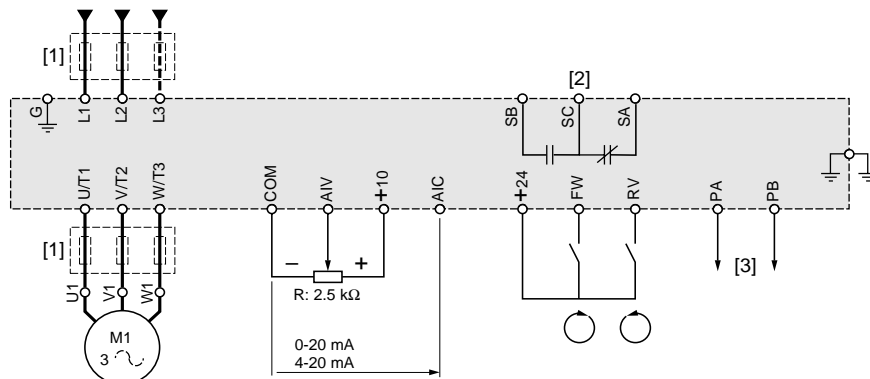

External power supply

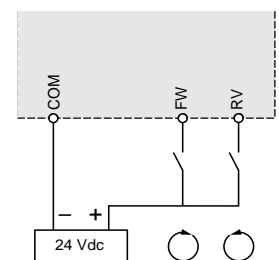

- [1] Possibility of filters and/or inductors.
- [2] Fault relay contacts: use to remotely indicate state of drive.
- [3] Optional brake resistance.

## ATV16U18N4 to 16U72N4 Wiring of 400/460 V three-phase

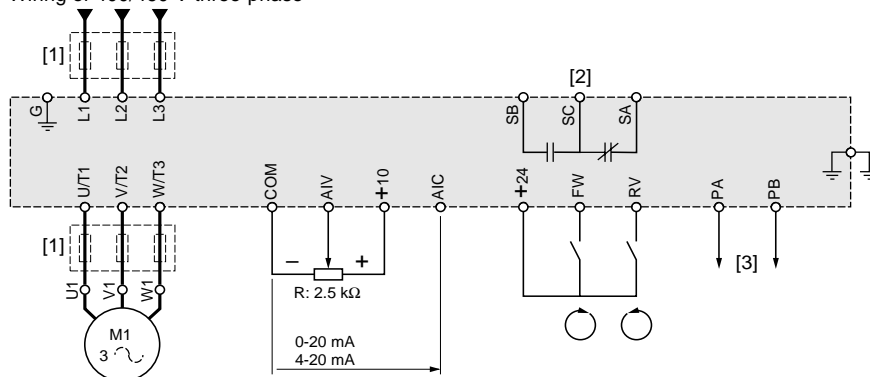

External power supply

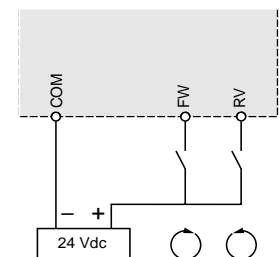

- [1] Possibility of filters and/or inductors.
- [2] Fault relay contacts: use to remotely indicate state of drive.
- [3] Optional brake resistance.









## Materials handling



## Pumps, fans



## High speed motors: textiles, wood



■ 50/60 Hz [1] ● L ● yes ● 5 kHz ● 1.5 In no	▲ 40...200 Hz ■ n-L ■ yes/no ● 5 kHz ● 1.5 In no	▲ 40...200 Hz ■ n-P-L ■ yes/no ● 5 kHz ● 1.5 In ■ yes/no	■ 50/60 Hz [1] ● P no ● 10 kHz ● 1.2 In no	▲ 40..70/80 Hz ● P no ● 10 kHz ● 1.2 In no	▲ 40...70/80 Hz ● P no ■ 5/10 kHz ● 1.2 In no	■ 50/60 Hz [1] ● L no ● 5 kHz ● 1.2 In ● yes	▲ 40...400 Hz ■ n-L no ● 5 kHz ● 1.2 In ▲ yes	▲ 40...400 Hz ■ n-P-L no ● 5 kHz ● 1.2 In ■ yes/no
---	---	---	---	---	--	---	--	---

●	●	■	●	●	■	●	●	●
		■			■			
		■			■			
●	▲	■			■			
		■			■			
		■			■			
		■			■			
●	●	■			■			
●	▲	▲			■			
		■			■			
●	●	■	●	●	●	●	●	●
		■			■			
●	●	■			■			
		■			■			
●	●	■	●	●	●	●	●	■
		■			■			■

●	▲	■			■			
	■	■			■			
			●	▲	■			■
			●	■	■			■
					■			■
					■			■

ATV16 7 + VW3A16201 11	ATV16 7 + VW3A16201 11 + VW3A16101 10 or VW3A16102 10	ATV16 7 + VW3A16201 11 + VW3A16104 10	ATV16 7 + VW3A16202 11	ATV16 7 + VW3A16202 11 + VW3A16101 10 or VW3A16102 10	ATV16 7 + VW3A16202 11 + VW3A16104 10	ATV16 7 + VW3A16203 11	ATV16 7 + VW3A16203 11 + VW3A16101 10 or VW3A16102 10	ATV16 7 + VW3A16203 11 + VW3A16104 10
------------------------------------	--	--	------------------------------------	--	--	------------------------------------	--	--



## Volts/frequency ratio to the motor

### Function

Adjustment of volts/frequency ratio, a function of the input power, the motor and the application.

### Applications

All constant and variable torque applications with or without overspeeding.

### Adjustment parameters

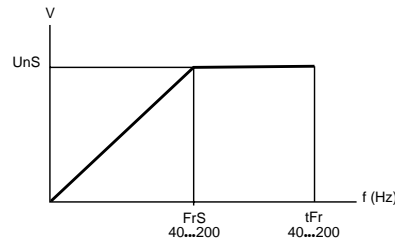

UnS: Nominal motor voltage (V)  
 FrS: Nominal motor frequency (Hz)  
 tFr: Maximum drive output frequency (Hz)

### Adjustments

UnS: - **ATV16U●●M2** drives: 208-220-230-240, preset to 230,  
 - **ATV16U●●N4** drives: 380-400-415-460, preset to 400 if FrS = 50, or 460 if FrS = 60.

FrS: 40 to 200, preset to 50 (or 60 using switch on the Altivar 16).  
 Adjustment of FrS overrides selection made with switch.

tFr : 40 to 200, preset to 50 if FrS = 50, or 60 if FrS = 60.

**Note:** The maximum value of FrS and tFr (200 Hz) varies in the following cases:  
 - Drive with variable torque card **VW3-A16202**: maximum value is 70/80 Hz  
 - Drive with high speed motor card **VW3-A16203**: maximum value is 400 Hz.

## Type of volts/frequency ratio

### Function

The volts/frequency ratio is adapted to suit the application in order to optimize performance.

### Applications

Standard applications at constant torque (machines requiring normal torque at low speed): ratio **n**  
 Variable torque applications (pumps, fans): ratio **P**  
 Machines requiring high torque at low speed, machines with fast cycles, special motors: ratio **L**

### Adjustment parameters

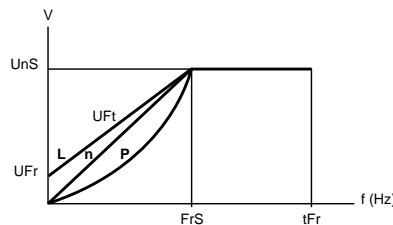

UFt : Type of volts/frequency ratio  
 UFr : Correction to the volts/frequency ratio  
 by modification of the IR compensation

### Adjustments

UFt: n, L or P, preset to **n**  
 UFr: 0 to 100, preset to 20  
 From 20 to 0: decrease of available torque at low speed  
 From 20 to 100: increase of available torque at low speed

## Speed range

### Function

The two frequency limits, HSP and LSP, define the speed range permitted under operating conditions.

### Applications

All applications.

### Adjustments

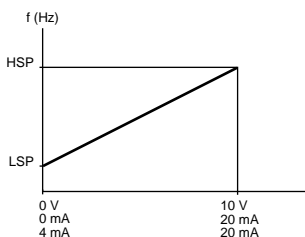

Reference

LSP : 0 to HSP, preset to 0  
HSP : LSP to tFr,  
preset to 50 if FrS = 50, or 60 if FrS = 60

## Frequency loop gain

### Function

Drive compensates for variances in machine load to improve performance during transient phases.

### Applications

All applications, from machines with fast cycles and low inertia to high inertia applications.

### Adjustments

FLG: 0 to 99, preset to 33  
From 33 to 0: reduction of gain (machine with high resistive torque or high inertia)  
From 33 to 99: increase of gain (machine with fast cycles and low inertia)  
Code nFL: no frequency loop  
Example 1

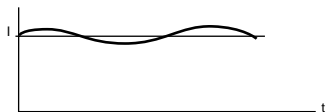

Instability of motor current  
In each case, reduce the gain.

Example 2

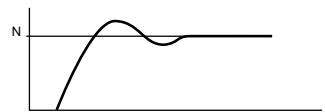

Overspeed during a transient phase

## Slip compensation

### Function

Maintain a constant speed to the motor for a given reference as the load changes, automatically correcting the frequency.

### Applications

All applications which require a broad speed range with wide variations in resistive torque.

### Adjustment

SLP: yes or no, preset to yes.

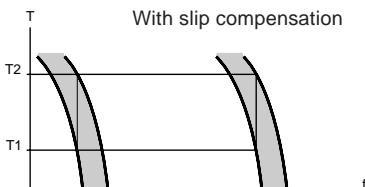

Slip compensation must be inhibited in the following cases:

- High inertia machines
- Synchronous reluctance motor
- Variable torque applications (pumps and fans)

With the VW3A1604 option, adjustment is possible from 0 to 5 Hz.



## Automatic deceleration ramp adaptation

### Function

Automatic adaptation of deceleration ramp time if initial setting was too low taking into account the load inertia. This function prevents the possibility of tripping due to an **overbraking fault**.

### Applications

All applications not requiring a controlled stop on the deceleration ramp.

### Adjustment

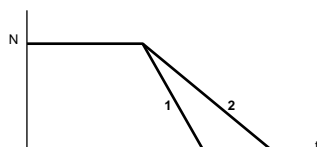

- 1 Initial adjustment
- 2 Automatic adjustment

brA: yes or no, preset to yes.

Automatic adaptation must be overridden in the case of a machine with stop positioning following the ramp.

## Motor thermal overload protection

### Function

Indirect protection of the motor by continuously calculating  $I^2t$ . This function insures motor thermal protection in the following cases:  
 - Ambient motor temperature  $\leq 40^\circ\text{C}$   
 - Prolonged running between 25/30 Hz and 50/60 Hz with a self-ventilated motor.

### Adjustments

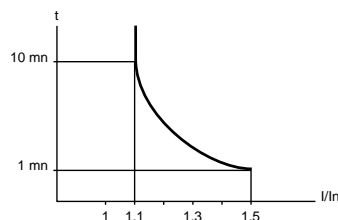

$I_{tH}$  : 0.5 to 1.05 times the continuous drive output current, preset to 0.9.

Adjust to the motor nameplate full load current.

To override thermal protection, increase value to the maximum.

## Switching frequency

### Function

A high switching frequency allows the drive to supply the motor with a current waveform with low harmonics. The switching frequency is modulated to reduce noise generated by the motor.  
 Value: 5 kHz with  $\pm 1$  kHz modulation.

### Applications

Applications: Pumps, fans, or constant torque applications requiring a low level of motor noise at low speed.

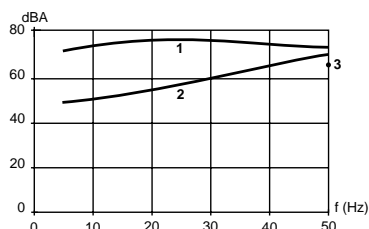

- 1 Switching at 5 kHz
- 2 Switching at 10 kHz
- 3 Motor connected directly to input supply

With option **VW3A16104**, switching frequency can be set to 10 kHz with a modulation of  $\pm 1$  kHz.

With the variable torque card, **VW3A16202**, switching frequency is fixed at 10 kHz.

Curves above generated with a 3 hp (2.2 kW), 4-pole motor

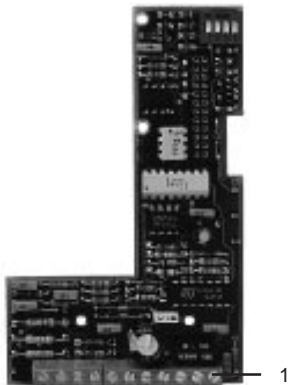

1

## Option cards: description

The option cards have the following terminals [1].

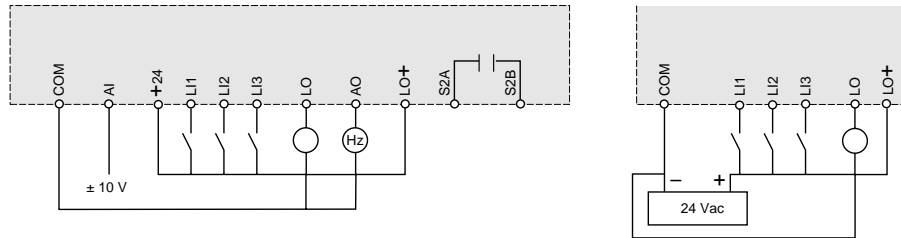

## Terminal descriptions

COM	Two 0 V outputs, common to internal drive supplies
+ 24	+24 V internal to drive, 60 mA maximum
AI	Analog input, $\pm 10$ V, impedance 30 k $\Omega$ , resolution 2.5 mV
LI1-LI2-LI3	3 logic inputs, impedance 1.5 k $\Omega$ +24 V (maximum 30 V), 0 state if < 5 V, 1 state if > 11 V
LO	Programmable logic output (open collector transistor) Maximum 24 Vdc, 200 mA (20 mA maximum current if connected to +24 V internal supply)
LO+	Logic output supply, 24 Vdc, 20 mA with internal supply or 200 mA with external supply
AO	Analog output, 0-20 mA, recommended load impedance 500 $\Omega$
S2A-S2B	Normally open relay contact Minimum switching power: 10 mA for 1 Vdc Maximum switching power on inductive load: 1 A for 250 VAC or 30 Vdc

## Factory settings for inputs/outputs (without adjustment option)

The I/O are set for various functions depending on which option card is used.

Inputs/outputs	Functions			
	Material handling	General use	Variable torque	High speed motors
Input AI	Reference summing	Reference summing	Manual reference	Reference summing
Input LI1	Reset after fault	Reset after fault	Freewheel stop	Jog
Input LI2	Preset speeds	Freewheel stop	Auto/manual reference switching	Switch to ramp 2
Input LI3	Preset speeds	Jog	DC injection braking	Freewheel stop
Output LO	Current limit reached	100% thermal state reached	Reference attained	1.1 In overload attained
Output AO	Motor frequency	Motor frequency	Motor frequency	Motor frequency
Output S2A-S2B	Brake control	Reference attained	High speed attained	Reference attained



**SQUARE D**

## Speed reference summing

Available on: **VW3A16201, VW3A16202, VW3A16203.**  
Analog input AI

### Function

$\pm 10$  V reference input summed with the AIV or AIC inputs.

### Applications

Machines for which the speed is controlled by an external parameter.



**Note:** manual reference is not summed; see **auto/manual function** on page 24.

## Speed regulation

Available on: **VW3A16201 + VW3A16104.**  
Analog input AI

### Function

Speed regulation with feedback by tachogenerator. Precision:  $\pm 0.1$  % of the maximum speed for a torque variation of  $0.2 T_n$  to  $T_n$  and a speed range of 1 to 50 Hz or 1.2 to 60 Hz.

### Applications

Machines requiring constant speed as motor load varies from 20% to 100% of full load.

### Wiring schematic

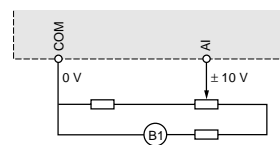

Customer must provide an external resistor network to divide the voltage for adaptation of the drive to the tachogenerator voltage.

**Note:** The drive insures that the input supply and the tachogenerator are galvanically isolated.

## PI feedback

Available on: **VW3A16202 + VW3A16104.**  
Analog input AI

### Function

Simple regulation of flow or pressure or other process variable.

### Applications

Pumps and fans.

### Wiring schematic

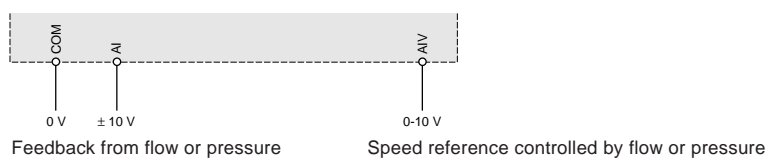

### Switch to ramp 2

Available on:

- VW3A16201 + VW3A16104
  - VW3A16202 + VW3A16104
  - VW3A16203 with or without VW3A16101, VW3A16102 or VW3A16104
- 1 logic input, either LI1, LI2 or LI3.

#### Function

Switching to a second acceleration and deceleration ramp time, individually adjustable.

#### Applications

Material handling applications which require smooth starting and stopping.  
High speed spindles with acceleration and deceleration limits above certain speeds.

Example:

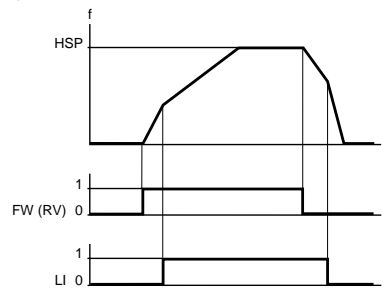

Factory settings:

Acc1 and dEc1: 3 s

Acc2 and dEc2: 12 s

### Preset speeds

Available on:

- VW3A16201 with or without VW3A16101, VW3A16102 or VW3A16104
- VW3A16203 + VW3A16104

Logic input LI2 or both LI2 and LI3.

#### Function

Use of preset speeds.

#### Applications

Material handling applications and machines which function at up to 4 speeds.

Example with 4 speeds:

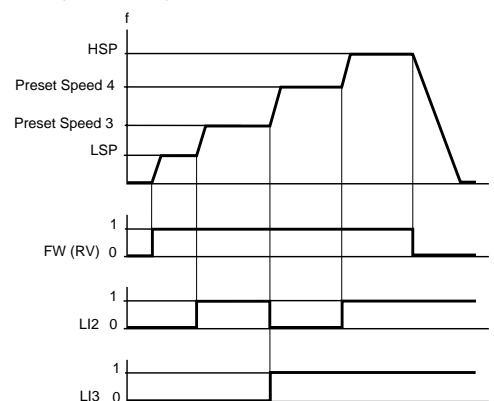

Factory settings:

Preset speed 1: LSP = 0

Preset speed 2: HSP = 50 Hz

Preset speed 3: 5 Hz

Preset speed 4: 25 Hz

**Note:** If there is a reference speed at AIV, AIC or AI, preset speed 1 is that reference speed instead of LSP.



## Reduce current limit

Available on: **VW3A16201 + VW3A16104**. 1 logic input, either LI1, LI2 or LI3.

### Function

Reduction of maximum current on the Altivar 16.

### Adjustment

0.5 to 1.5 times the continuous drive output current.

### Applications

Machines which may frequently jam such as conveyors, grinders and extruders.  
Torque regulation or simple tension-controlled applications.  
Use with a motor that has a power less than that of the drive.

## +Speed/- speed

Available on: **VW3A16201 + VW3A16104**. Logic inputs LI1 and LI2.

### Function

Increase and decrease speed by using two logic inputs, with or without storing last reference (similar to a motorized potentiometer).

### Applications

Command for a multi-drive system.

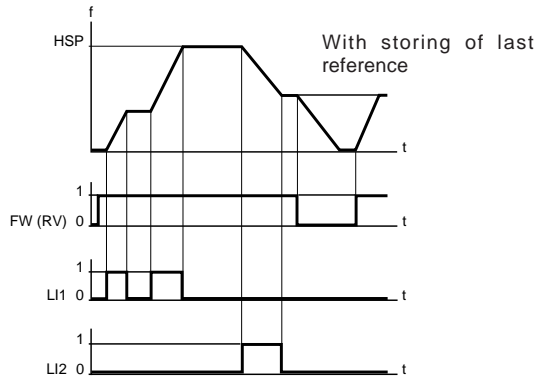

## Jog

Available on: **VW3A16201** and **VW3A16203**, with or without **VW3A16101**, **VW3A16102** or **VW3A16104**.  
1 logic input LI1, LI2 or LI3.

### Function

Jog function with a minimum ramp of 0.1 s and a reference speed up to 10 Hz (factory preset to 5 Hz). Minimum time between two jog pulses is 0.5 s.

### Applications

Machines which run in manual.  
Used to move slightly forward when performing maintenance.

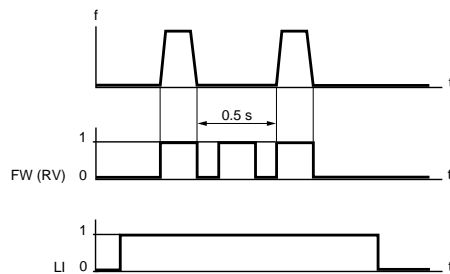



## Fast stop

Available on: **VW3A16201 + VW3A16104.**  
1 logic input LI1, LI2 or LI3.

### Function

Braking to standstill with minimum deceleration time acceptable to the drive/motor combination without tripping on **overbraking**.

### Applications

Conveyors with electric brake (optimization of the braking time depending on the load).

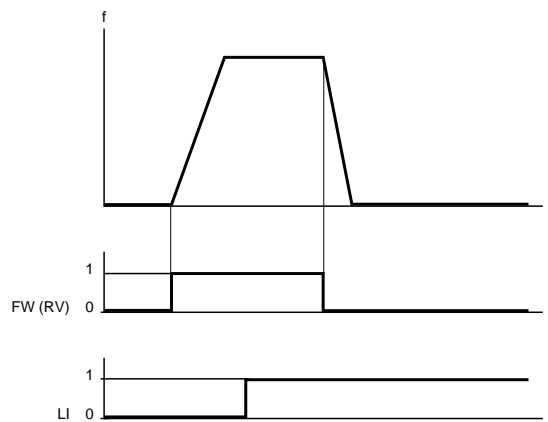

## Freewheel stop

Available on: **VW3A16201, VW3A16202, VW3A16203.**  
1 logic input LI1, LI2 or LI3.

### Function

Motor coasts to a stop. Motor and load deceleration time depends on motor speed, machine inertia and resistive torque.

### Applications

Stopping with a mechanical brake or for positioning.  
When bypassing the drive (pumps).

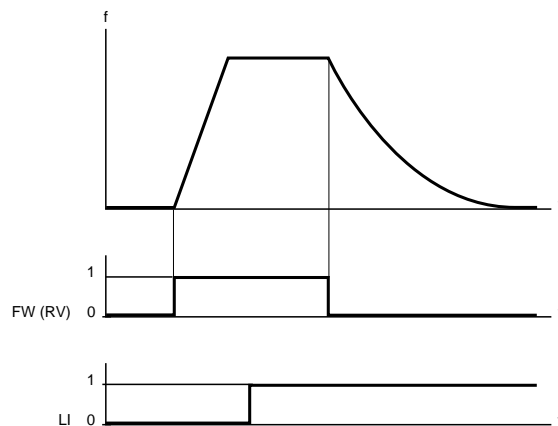

## DC injection braking

Available on: **VW3A16202** with or without **VW3A16101**, **VW3A16102** or **VW3A16104**.  
Logic input LI3.

### Function

DC injected when logic input is validated.

### Applications

Braking at low speed for fans with high inertia.

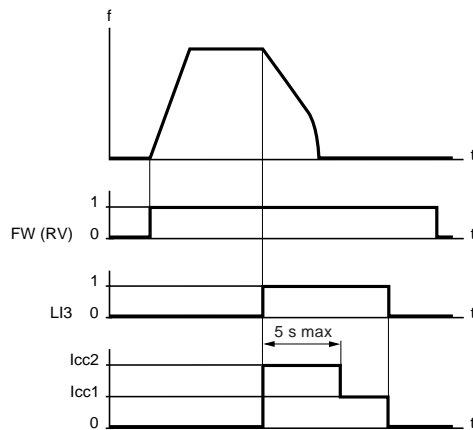

Programmed values:

- Icc1: 0.5 times ItH
- Icc2: 1.5 times ItH
- injection time at Icc2: 5 s

Programmable values with **VW3A16104** option:

- Icc2: between 0.5 and 1.5 times ItH
- Injection time at Icc2: between 0 and 5 s

## Automatic/manual

Available: **VW3A16202** with or without **VW3A16101**, **VW3A16102** or **VW3A16104**.  
Logic input LI2.

### Function

Switching between two analog references.

### Applications

Pumps and fans with automatic/manual operation.

Automatic control with 0-20 mA or 4-20 mA at AIC.  
Manual control by potentiometer at AI (local control).

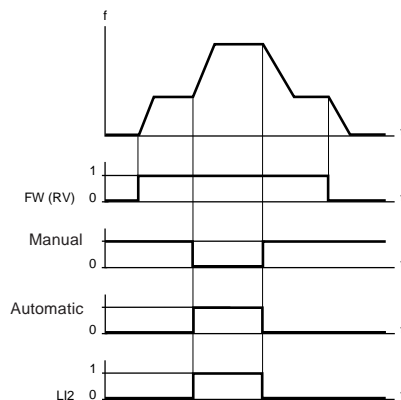

Wiring schematic

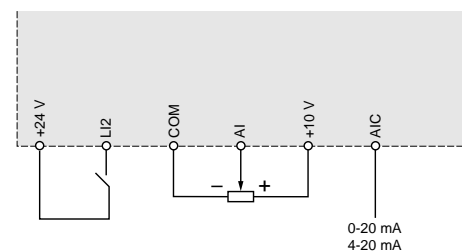

### Run/stop

Available on: **VW3A16201 + VW3A16104**.  
Logic input LI2.

#### Function

Run/stop with a single command.

#### Applications

Simplified sequences, remote control.

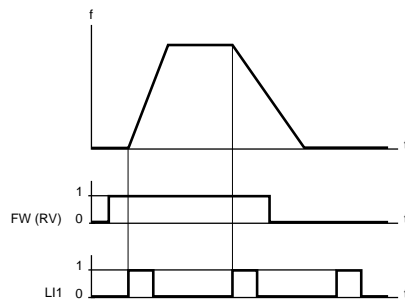

### Reset after fault

Available on: **VW3A16201** with or without **VW3A16101**, **VW3A16102** or **VW3A16104**.  
1 logic input LI1, LI2 or LI3.

#### Function

Erase fault and reset the drive (if the cause of the fault has been corrected).  
Applicable faults: overvoltage (OSF), motor overload (OLF), overbraking (ObF).

#### Applications

Remote reset.  
Simplified control sequence without line contactor.

### Motor power change

Available on: **VW3A16201 + VW3A16104**.  
1 logic input LI1, LI2 or LI3.

#### Function

Use of one drive on either of two motors with different ratings. Switching between motors is performed by an appropriate drive output sequence. The switching must be made with the drive disabled. This function allows optimization of both motors.

The following parameters are automatically changed by the logic command:

- Volts/frequency ratio (UFr)
- Slip compensation
- Ith (thermal protection inhibited)
- Current threshold of brake control logic
- Automatic DC injection

Adjustments with option VW3A16104 are possible for a power ratio of 1 to 5.

#### Applications

Material handling with several movements, 2 of which are not simultaneous.  
Machines with several sections, 2 of which do not operate simultaneously.



## Brake control logic

Available on **VW3A16201** with or without **VW3A16101**, **VW3A16102** or **VW3A16104**.  
Function programmed to adjustable values, assigned to the S2A-S2B output.

### Function

Brake control logic is generated by the drive with the material handling card, taking into account the current threshold, the brake release time delay, the brake release threshold and the brake engage threshold.

### Applications

Material handling machines equipped with failsafe brakes, such as hoisting machines.  
Machines which need a holding brake, such as an unbalanced machine.

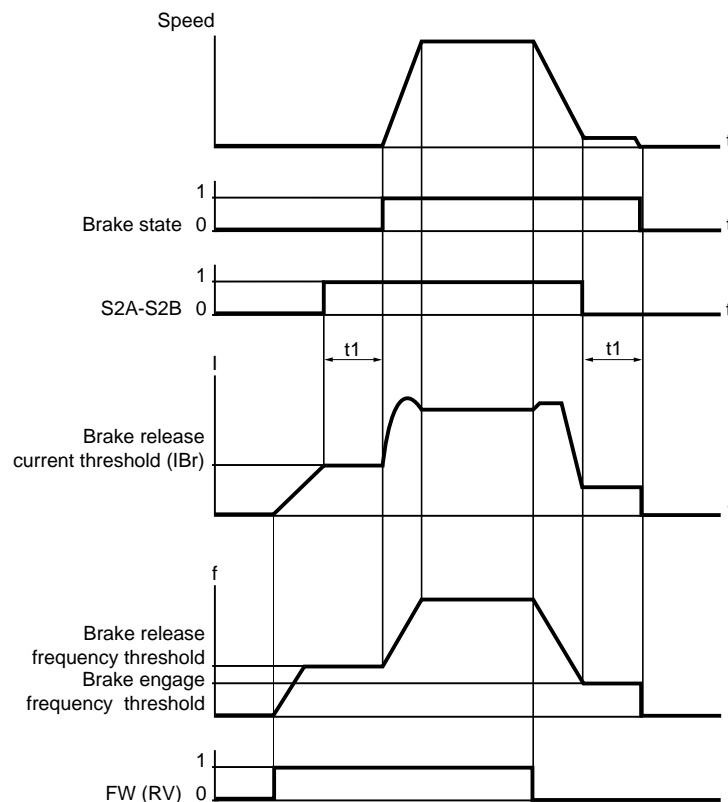

Programmable and adjustable values:

- Current threshold ( $I_{br}$ ) = 0, adjustable between 0 and 1.05 times  $I_n$  by use of option **VW3A16101**, **VW3A16102** or **VW3A16104**
- brake release time delay  $t_1$  = 0, adjustable between 0 and 5 s on option **VW3A16104**
- brake release threshold = brake engage threshold = value of LSP. With option **VW3A16104** the two levels are individually adjustable.



### Detection of speed attained

Available on: **VW3A16201**, **VW3A16202**, **VW3A16203**.  
Outputs LO and S2A-S2B.

#### Function

Detection of a set level of speed attained by the motor.  
3 levels of frequency can be programmed:

- Reference speed attained, with **VW3A16201**, **VW3A16202** or **VW3A16203**
- Low speed (LSP) attained, with **VW3A16201 + VW3A16104**
- High speed (HSP) attained, with **VW3A16202**, or **VW3A16201 + VW3A16104**

#### Use

Detection of speed attained is used for a prealarm or alarm.

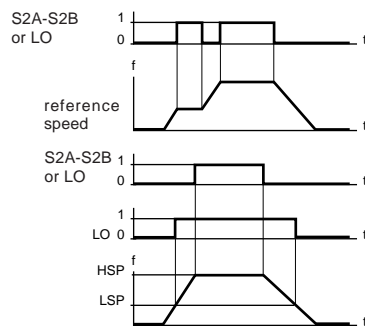

### Detection of a current level attained

Available on: **VW3A16201** and **VW3A16203**.  
Output LO.

#### Function

Detection of a current level absorbed by the motor. Two values can be programmed:

- Current limit attained, with **VW3A16201** option
- Overload of 1.1 In attained (In = value of Ith), with options **VW3A16201 + VW3A16104** or **VW3A16203**.

#### Use

Detection of a current level attained can be used for a prealarm or alarm.

### Detection of 100% thermal state attained

Available on: **VW3A16201** with or without **VW3A16104**.  
Preset to output LO, can be set to output S2A-S2B.

#### Function

Detection of 100% thermal state attained.

#### Use

Detection of 100% thermal state attained can be used for a prealarm or alarm.

### Analog output

Available on: **VW3A16201**, **VW3A16202**, **VW3A16203**.  
Output AO.

#### Function

0 to 20 mA output signal. Can be set for:

- Motor frequency (20 mA = HSP)
- Motor current with **VW3A16104** (20 mA = 1.82 times the continuous drive output current).



## S ramps

Available on: **VW3A16104, VW3A16201** with or without **VW3A16101, VW3A16102** or **VW3A16104**.

### Function

Progressive ramping of the output frequency, following the reference speed.

### Applications

Material handling: Use of S ramp prevents jolts in the event of mechanical play, and reduces the possibility of not following the speed during rapid transient phases.

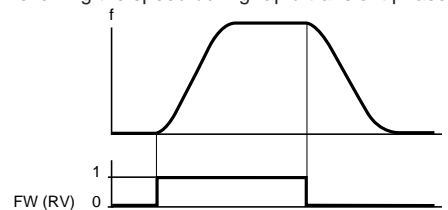

## Skip frequencies

Available on: **VW3A16202 + VW3A16101, VW3A16102** or **VW3A16104**.

### Function

Suppression of critical speeds caused by mechanical resonance. It is possible to cause the motor to skip 1 or 2 preset frequencies with a bandwidth of 2 Hz.

### Applications

Pump, fans, machines with light structure.

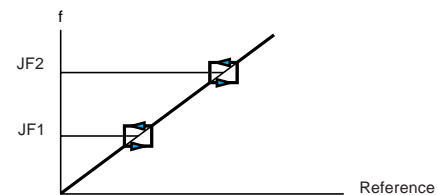

Factory settings:

JF1 = 0 (inactive)  
JF2 = 0 (inactive)

## Controlled stop on loss of input power [1]

Available on:

- **VW3A16104**
- **VW3A16201 + VW3A16101, VW3A16102** or **VW3A16104**
- **VW3A16202 + VW3A16101, VW3A16102** or **VW3A16104**
- **VW3A16203 + VW3A16104**

### Function

Controlled stop of the motor on loss of input supply power, following a self-adjusting ramp which is a function of the regenerated energy.

### Applications

Material handling  
Machines with high inertia  
Continuous process machines

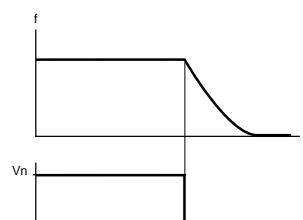

[1] ATV-16U●●N4 only.

---

## Catching a spinning load

---

Available on:

- **VW3A16104**
- **VW3A16201 + VW3A16101, VW3A16102 or VW3A16104**
- **VW3A16202 and VW3A16203, with or without VW3A16101, VW3A16102 or VW3A16104**

---

### Function

Smooth restarting of the motor after a short input line undervoltage. When restarted, the output frequency is immediately equal to the reference frequency. The acceleration ramp does not begin at zero. Supply voltage, reference frequency and a direction command (FW or RV) must be maintained for this function to operate.

---

### Applications

Machines for which the loss of motor speed is slight during the input line undervoltage (machines with high inertia, process control machines).

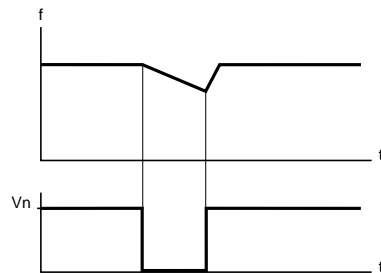

---

## Automatic restart

---

Available on:

- **VW3A16104**
- **VW3A16201 + VW3A16101, VW3A16102 or VW3A16104**
- **VW3A16202 with or without VW3A16101, VW3A16102 or VW3A16104**

---

### Function

Automatic restart after the drive trips on one of the faults below if the cause of the fault has been corrected.

Faults:

- Overvoltage (OSF)
- Overbraking (ObF)
- Overload (OLF)

In the case of overvoltage or overbraking, the drive remains disabled for 1 minute and automatically restarts if the fault has disappeared and if the other operating conditions allow. If the fault remains, the above sequence is repeated 4 times (a maximum of 5 sequences) before the drive faults and has to be reset.

In case of motor overload, the drive remains disabled for as long as the thermal state stays above 100%. Restarting is possible if the other operating conditions allow.

In each of these three cases, the drive fault relay (SA-SB) remains closed.

Supply voltage, reference frequency and a direction command (FW or RV) must be maintained for this function to operate.

---

### Applications

Machines or installations which run continually or without monitoring, where the restarting does not present any danger for personnel or product (pumps, fans).





ATV-16U09M2



VW3A16101



VW3A16104



VW3A16201

## Drive controllers with frequency range 0.1 Hz to 50/60 Hz

50/60 Hz mains supply Supply voltage V	Line Current		Motor		Altivar 16 Catalog Numbers
	1Ø	3Ø	Rating kW	hp	
208...240 single-phase	4	—	0.37	0.5	<a href="#">ATV16U09M2</a> [1]
	7	—	0.75	1	<a href="#">ATV16U18M2</a> [1]
208...240 single-phase or three-phase	14	10	1.5	2	<a href="#">ATV16U29M2</a> [1]
	18	14	2.2	3	<a href="#">ATV16U41M2</a> [1]
400...460 three-phase	—	3.3	0.75	1	<a href="#">ATV16U18N4</a> [1]
	—	6	1.5	2.2	<a href="#">ATV16U29N4</a> [1]
	—	9	2.2	3	<a href="#">ATV16U41N4</a> [1]
	—	12	3	4	<a href="#">ATV16U54N4</a> [1]
	—	16	4	5	<a href="#">ATV16U72N4</a> [1]

## Accessories and options

Item	For drives	Catalog Numbers
Display/adjustment option	ATV16 all models	<a href="#">VW3A16101</a> [1]
Display/adjustment/ local control option	ATV16 all models	<a href="#">VW3A16102</a> [1]
Remote mounting kit for display/adjustment options	ATV16 all models	<a href="#">VW3A16103</a>
PC connection option	ATV16 all models	<a href="#">VW3A16104</a>
General use/material handling option card	ATV16 all models	<a href="#">VW3A16201</a> [1]
Variable torque option card (pumps, fans)	ATV16 all models	<a href="#">VW3A16202</a> [1]
High speed motor option card (textile, wood machines)	ATV16 all models	<a href="#">VW3A16203</a> [1]

[1] To receive a user guide with the product, add the letter specifying the required language (U, E, F, G or S).





## Accessories and options (continued)

Item	For drives	Catalog Numbers
RFI filters	ATV16U09M2, 16U18M2	<b>VW3A16401</b>
	ATV16U29M2 (single-phase supply)	<b>VW3A16402</b>
	ATV16U29M2 (three-phase supply) ATV-16U41N4, 16U54N4	<b>VW3A16403</b>
	ATV16U41M2 (single-phase supply)	<b>VW3A16404</b>
	ATV16U41M2 (three-phase supply)	<b>VW3A16405</b>
	ATV16U18N4, 16U29N4	<b>VW3A16406</b>
	ATV16U72N4	<b>VW3A16407</b>
Mounting kits for Altivar 16 and filters	ATV16U09M2, 16U18M2	<b>VW3A16408</b>
	ATV16U29M2, 16U41M2 ATV16U18N4, 16U29N4 ATV16U41N4, 16U54N4 ATV16U72N4	<b>VW3A16409</b>
	Inductors	<b>VW3A16501</b>
Inductors	ATV16U09M2, 16U18M2	<b>VW3A16501</b>
	ATV16U29M2, 16U41M2 (single-phase supply)	<b>VW3A16502</b>
	ATV16U29M2, 16U41M2 (three-phase supply) ATV16U54N4, 16U72N4	<b>VW3A16503</b>
	ATV16U18N4, 16U29N4 ATV16U41N4	<b>VW3A16504</b>
Braking module	ATV16U09M2, 16U18M2	<b>VW3A16601</b>
Braking resistor	ATV 16 all models	<b>VW3A16705</b>



VW3A16406



VW3A16601





# From single products to complete systems, look to Square D.

Square D Company is a leading manufacturer and supplier of electrical distribution, automatic and industrial control products. The full line of Square D and Telemecanique brand products are available from an extensive network of Square D distributors located throughout North America.

Square D Company is part of Groupe Schneider, a global manufacturer of electrical distribution, automation and industrial equipment.

Square D has been serving industrial and construction markets, as well as public utilities, individual consumers and government agencies for over 90 years. We offer unsurpassed quality, innovative design and a committed staff of trained sales representatives and service technicians willing to stand behind every product we sell.

For further information on how we can help fill your electrical needs, call your local Square D field representative or authorized Square D distributor.

Square D Company  
P.O. Box 27446  
Raleigh, N.C. 27611, USA

Schneider Canada  
6675 Rexwood Road  
Mississauga, Ontario L4V 1V1

Schneider Mexico, SA de C.V.  
Calz. Javier Rojo Gomez No. 1121  
Col. Guadalupe del Moral, Iztapalapa  
09300 Mexico D.F., Mexico

ALTIVAR™ is a trademark of Telemecanique S.A. or its successor-in-interest, Schneider S.A.





## Artisan Technology Group is your source for quality new and certified-used/pre-owned equipment

- FAST SHIPPING AND DELIVERY
- TENS OF THOUSANDS OF IN-STOCK ITEMS
- EQUIPMENT DEMOS
- HUNDREDS OF MANUFACTURERS SUPPORTED
- LEASING/MONTHLY RENTALS
- ITAR CERTIFIED SECURE ASSET SOLUTIONS

### SERVICE CENTER REPAIRS

Experienced engineers and technicians on staff at our full-service, in-house repair center

### *InstraView*<sup>SM</sup> REMOTE INSPECTION

Remotely inspect equipment before purchasing with our interactive website at [www.instraview.com](http://www.instraview.com) ↗

### WE BUY USED EQUIPMENT

Sell your excess, underutilized, and idle used equipment. We also offer credit for buy-backs and trade-ins. [www.artisanng.com/WeBuyEquipment](http://www.artisanng.com/WeBuyEquipment) ↗

### LOOKING FOR MORE INFORMATION?

Visit us on the web at [www.artisanng.com](http://www.artisanng.com) ↗ for more information on price quotations, drivers, technical specifications, manuals, and documentation

**Contact us:** (888) 88-SOURCE | [sales@artisanng.com](mailto:sales@artisanng.com) | [www.artisanng.com](http://www.artisanng.com)