



## Artisan Technology Group is your source for quality new and certified-used/pre-owned equipment

- FAST SHIPPING AND DELIVERY
- TENS OF THOUSANDS OF IN-STOCK ITEMS
- EQUIPMENT DEMOS
- HUNDREDS OF MANUFACTURERS SUPPORTED
- LEASING/MONTHLY RENTALS
- ITAR CERTIFIED SECURE ASSET SOLUTIONS

### SERVICE CENTER REPAIRS

Experienced engineers and technicians on staff at our full-service, in-house repair center

### *InstraView*<sup>SM</sup> REMOTE INSPECTION

Remotely inspect equipment before purchasing with our interactive website at [www.instraview.com](http://www.instraview.com) ↗

### WE BUY USED EQUIPMENT

Sell your excess, underutilized, and idle used equipment. We also offer credit for buy-backs and trade-ins. [www.artisanng.com/WeBuyEquipment](http://www.artisanng.com/WeBuyEquipment) ↗

### LOOKING FOR MORE INFORMATION?

Visit us on the web at [www.artisanng.com](http://www.artisanng.com) ↗ for more information on price quotations, drivers, technical specifications, manuals, and documentation

**Contact us:** (888) 88-SOURCE | [sales@artisanng.com](mailto:sales@artisanng.com) | [www.artisanng.com](http://www.artisanng.com)

# TSX 17 micro-PLCs

## TSX 17-10/20 micro-PLCs

Characteristics :  
 Pages 41101/7 to 41101/9  
 References, dimensions :  
 Pages 41101/10 and 41101/11  
 Connections :  
 Pages 41101/12 to 41101/15

## TSX 17-10 selection, description

TSX 17-10 and TSX 17-20 micro-PLCs comprise a compact 20 to 40 I/O base, compact modular extensions to increase the number of I/O to 160, and intelligent analogue, timer and communication modules. These micro-PLCs are suitable for both simple, small scale control systems and more complex systems which use analogue processing and communication.

### Selection

<b>Discrete I/O</b>				
<b>Maximum number</b>	88	102	100	120
<b>Discrete I/O</b>				
<b>Basic number</b>	20	34	20	40
<b>No. of extensions (1)</b>	2	2	2	2
<b>Power supply</b>	~110/240 V	~110/240 V	≡ 24 V	≡ 24 V
<b>Inputs</b>	≡ 24 V isolated	≡ 24 V isolated	≡ 24 V	≡ 24 V
<b>Outputs</b>	Relay	Relay	Transistor 1 and 2 A	Transistor 1 and 2 A
<b>Maximum memory size</b>	8 Kb	8 Kb	8 Kb	8 Kb
<b>FIPIO bus/ FIPWAY network</b>	No	No	No	No
<b>UNI-TELWAY link</b>	No	No	No	No
<b>TSX 17-10 micro-PLCs</b>	<b>TSX 171 2028E</b>	<b>TSX 171 3428E</b>	<b>TSX 171 2002E</b>	<b>TSX 171 4002E</b>

(1) No intelligent modules.

### Description

TSX 17-10 micro-PLCs are programmed in PL7-1 Boolean language and have a single task software structure. Each TSX 17-10 micro-PLC base consists of a processor with an 8 K byte internal RAM memory.

The front panel comprises :

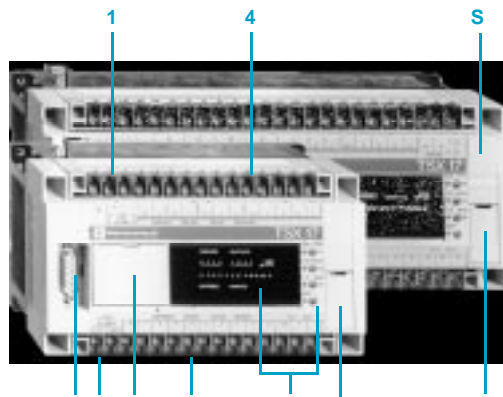

- 1 A ~110/240 V, 50/60 Hz or ≡ 24 V power supply
- 2 An RS 485 port for connection to the programming terminal
- 3 A slot for EEPROM or EPROM cartridge
- 4 20, 34 or 40 discrete I/O with screw terminals on removable terminal blocks (≡ 24 V inputs, relay or 1 and 2 A non-protected transistor outputs)
- 5 A ≡ 24 V sensor power supply (with the basic ~110/240 V - 50/60 Hz PLC)
- 6 A PLC and I/O status display panel
- 7 An I/O bus extension connector

### Separate parts

- S A backup battery for program and data memory
- 3 An 8 K byte EPROM or EEPROM memory cartridge for program backup

Backup system	Backup time for application program	Backup time for data
Internal memory	1 hour	1 hour
Battery	2 years	2 years
EEPROM/EPROM cartridge	Permanent	1 hour
EEPROM/EPROM cartridge and battery	Permanent	2 years

# TSX 17 micro-PLCs

## TSX 17-10/20 micro-PLCs

### TSX 17-20 selection, description

Characteristics :  
 Pages 41101/7 to 41101/9  
 References, dimensions :  
 Pages 41101/10 and 41101/11  
 Connections :  
 Pages 41101/12 to 41101/15

### Selection

<b>PL7-1 discrete I/O</b>						
<b>Maximum number</b>	88	88	102	102	100	120
<b>PL7-2 discrete I/O</b>						
<b>Maximum number</b>	122	122	136	136	140	160
<b>Discrete I/O</b>						
<b>Basic number (1)</b>	20	20	34	34	20	40
<b>PL7-1 extensions</b>						
<b>Maximum number</b>	2	2	2	2	2	2
<b>PL7-2 extensions (2)</b>	3	3	3	3	3	3
<b>of which intelligent modules</b>	3	3	3	3	3	3
<b>Power supply</b>	~110/240 V	~110/240 V	~110/240 V	~110/240 V	== 24 V	== 24 V
<b>Isolated inputs</b>	== 24 V	~ 110 V	== 24 V	~ 110 V	== 24 V	== 24 V
<b>Outputs</b>	Relay	Relay	Relay	Relay	Transistor 0.35 A	Transistor 0.35 A
<b>Maximum memory size</b>	24 Kb	24 Kb	24 Kb	24 Kb	24 Kb	24 Kb
<b>FIPIO bus/ FIPWAY network (3)</b>	Yes	Yes	Yes	Yes	Yes	Yes
<b>UNI-TELWAY link (3)</b>	Yes	Yes	Yes	Yes	Yes	Yes
<b>TSX 17-20 micro-PLCs</b>	<b>TSX 172 2028E</b>	<b>TSX 172 2044E</b>	<b>TSX 172 3428E</b>	<b>TSX 172 3444E</b>	<b>TSX 172 2012E</b>	<b>TSX 172 4012E</b>

(1) Not including 2 event-triggered inputs and 1 fast counter.

(2) Intelligent modules included, except for UNI-TELWAY bus slave adaptor or FIPIO/FIPWAY module.

(3) Only with PL7-2 language.

### Description

The TSX 17-20 micro-PLC is programmed in PL7-1 Boolean language (operations on bits). PL7-2 programs can be processed by adding the TSX P17 20 E● as standard language cartridge (on bits and on 16-bit words). There are two types of language cartridge (with or without real-time clock). Each micro-PLC base consists of a processor with a 24 K byte internal RAM memory.

The front panel comprises :

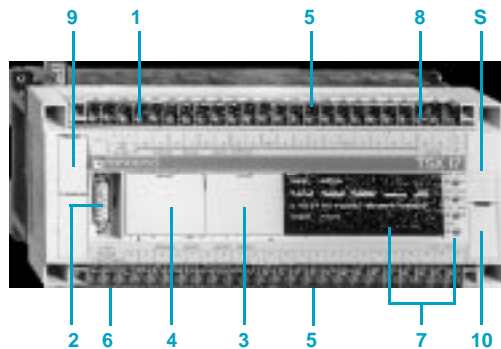

- 1 A ~110/240 V, 50/60 Hz or == 24 V power supply
- 2 An RS 485 port for connection to programming terminal, UNI-TELWAY multidrop bus or communication peripheral
- 3 A slot for an EEPROM or EPROM memory cartridge
- 4 A slot for a PL7-2 language cartridge
- 5 20, 34 or 40 discrete I/O with screw terminals on removable terminal blocks (== 24 V or ~ 110 V isolated inputs, relay or 0.35 A protected transistor outputs)
- 6 A == 24 V sensor power supply (with the basic ~110/240 V, 50/60 Hz PLC)
- 7 A PLC and I/O status display panel
- 8 Two == 24 V event-triggered inputs
- 9 A 2 kHz, ~ 5/24 V fast counter
- 10 An I/O bus extension connector

### Separate parts

**S** A backup battery for program and data memory

**3** An 8 or 24 K byte EPROM or EEPROM memory cartridge for program backup

Backup system	Backup time for application program	Backup time for data
Internal memory	1 hour	1 hour
Battery	2 years	2 years
EEPROM/EPROM cartridge	Permanent	1 hour
EEPROM/EPROM cartridge and battery	Permanent	2 years

# TSX 17 micro-PLCs

## TSX 17-10/20 micro-PLCs

Characteristics :  
 Pages 41101/7 to 41101/9  
 References, dimensions :  
 Pages 41101/10 and 41101/11  
 Connections :  
 Pages 41101/12 to 41101/15

## Functions

### Special I/O

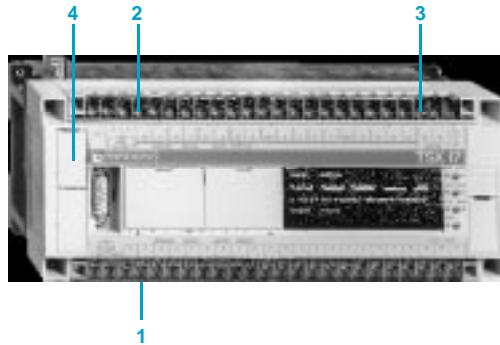

#### 1 Input for RUN/STOP control

Input I0,00 on the TSX 17-10/20 PLC base can be used for the PLC RUN/STOP control, if it is configured for this.

#### 2 Alarm output

Output O0,00 on the TSX 17-10/20 PLC base can be used as an alarm output for external safety circuits, if it is configured for this.

#### 3 Event-triggered inputs

The event-triggered inputs available on the TSX 17-20 PLC can be used with either PL7-1 or PL7-2 language. They consist of 2  $\pm$  24 V dedicated inputs, I0,24 and I0,25, with short filter times (< 1 ms).

The use of these inputs permits the immediate processing of events without waiting for the updating of the I/O associated with the Master task (total response time < 2 ms).

A change of state of either of these 2 inputs initiates the execution of the fast task cycle.

#### 4 Fast counter/timer

The TSX 17-20 PLC has a fast counting function which can be used with either PL7-1 or PL7-2 language. A 10000 point counter receives the pulses from the counting input (at a maximum frequency of 2 kHz). When the preset value is reached, the counter activates the fast task, thus permitting the control of the actions within a short, guaranteed response time.

Two inputs are associated with this function :

- a counting input which can receive pulses from a sensor (incremental encoder, proximity sensor, etc)
- a reset input which resets the counter to zero

These  $\pm$  24 V or  $\pm$  5 V inputs are available on a 9-way connector on the front panel. They are connected to an incremental encoder or a sensor by a TSX CCB 020 cable or a TSX CAC 04 solder connector.

### Real-time clock

Real-time clock parameters	
Nature	: second, minute, hour, day, month and year
Type	: current value and last PLC stop (STOP or power break)
Drift	: < 4 seconds per day
Backup	: on a power break, by lithium battery TSX 17 ACC 1 installed in the PLC base

When an application controlled by a TSX 17-20 PLC requires time-related data, the PLC must be equipped with PL7-2 language cartridges : TSX P17 20FB/FD1. In addition to PL7-2 software, these also include a real-time clock which is protected in the event of a power failure (backup time : 1 hour without battery, 2 years with battery).

This real-time clock continually provides the following functions :

- Timed and dated programming
- Event logging
- Elapsed time measurement

The real-time clock continually provides the following time parameters : second, minute, hour, day, month and year.

### Numerical display

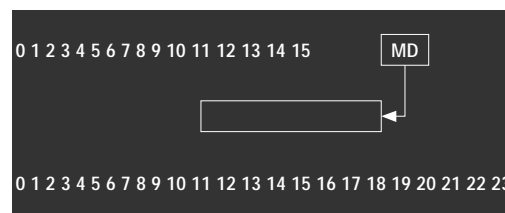

The TSX 17 ACC 2 numerical module can be fitted instead of the I/O display for TSX 17-20 PLCs running PL7-2 language.

The I/O are displayed on a 4-digit display (height 3.5 mm). This display corresponds to the contents of system word SW16 which can be programmed in BCD by the user program.

# TSX 17 micro-PLCs

## TSX 17-10/20 micro-PLCs

Characteristics :  
 Pages 41101/7 to 41101/9  
 References, dimensions :  
 Pages 41101/10 and 41101/11  
 Connections :  
 Pages 41101/12 to 41101/15

### Descriptions

#### Description of discrete I/O extensions

PLC bases and extensions have different types of discrete I/O :

- $\pm$  24 V isolated or non-isolated inputs, and  $\sim$  110 V isolated inputs
  - 0.35 A protected or 1 and 2 A non protected relay, triac, or transistor outputs
- Exchanges between the processor and the I/O interface are systematically performed on each PLC scan.

#### Operating safety

Fault bits and system bits for controlling the I/O are available to the user. Processing these bits in the user program permits downgraded operation and thus contributes to the analysis of first level application maintenance.

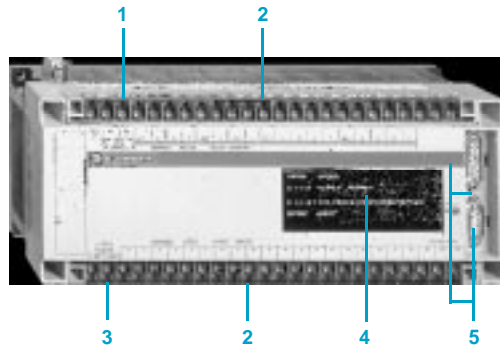

TSX DMF discrete extension blocks comprise :

- 1 A  $\sim$  110/240 V, 50/60 Hz or  $\pm$  24 V power supply
- 2 34 or 40 discrete I/O with screw terminals on removable terminal blocks ( $\pm$  24 V or  $\sim$  110 V isolated inputs, relay or transistor outputs)
- 3 A  $\pm$  24 V sensor power supply (with  $\sim$  110/240 V, 50/60 Hz unit)
- 4 An I/O status display panel
- 5 I/O bus extension connecting cable

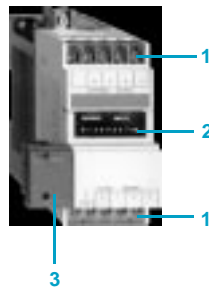

TSX DEF and TSX DSF discrete extension modules comprise :

- 1 Eight inputs or six outputs connected to screw terminals ( $\pm$  24 V or  $\sim$  110 V inputs, relay, triac or 0.35 A protected transistor outputs)
- 2 An I/O status display panel
- 3 An I/O bus extension connector

#### Description of analogue timer module

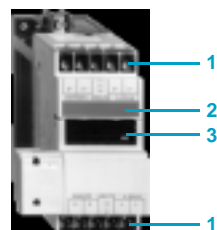

This module provides, on each of its 4 channels, the latch delay for a TSX 17-10/20 bit variable. Each channel can be adjusted using an internal or external potentiometer in accordance with 4 time ranges.

Potentiometer	Range 1	Range 2	Range 3	Range 4
Internal	0.1 to 1 s	0.15 to 1.5 s	1 to 10 s	10 to 100 s
External (1 M $\Omega$ )	0.1 to 6 s	0.15 to 9 s	1 to 60 s	10 to 600 s

The TSX DTF 400 analogue timer module comprises :

- 1 Two terminals for connecting external potentiometers or jumpers (supplied) if internal potentiometers are used
- 2 Four internal potentiometers
- 3 Four status indicator lamps :
  - blinking : time delay in progress
  - steady : time delay elapsed
 and a fault indicator lamp

# TSX 17 micro-PLCs

## TSX 17-10/20 micro-PLCs

### Compatibility and layout

Characteristics :  
pages 41101/7 to 41101/9  
References, dimensions :  
pages 41101/10 and 41101/11  
Connections :  
pages 41101/12 to 41101/15

### Compatibility

Configurations must conform to the table below :

- TSX 17-10 and TSX 17-20 micro-PLCs used with PL7-1 language can be extended by 2 discrete extension blocks or modules (it is possible to mix different blocks and modules).
- TSX 17-20 micro-PLCs used with PL7-2 language can be extended by 3 discrete extension or analogue communication extension blocks or modules and 1 UNI-TELWAY adaptor module (it is possible to mix different blocks and modules).  
The table below has been defined using a discrete I/O load rate of 60 %.

PLC base	Language	Max no. of extensions (1)	Discrete I/O extension blocks			Extension modules					UNI-TELWAY module	FIPIO/FIPWAY module	
			TSX DMF 242A 342A 344A	400	401	TSX DTF 400 TSX DEF 804/812	TSX DSF 604/612	635	TSX SCG 11●1 TSX AEG 411●	TSX ASG 200●			TSX 17 ACC5
TSX 171 2028 TSX 171 3428	PL7-1	2											
TSX 171 2002	PL7-1	2											
TSX 171 4002	PL7-1	2											
TSX 172 2028 TSX 172 2044	PL7-1	2											
	PL7-2	3								(2)	(3)	(3) (6)	
TSX 172 2012	PL7-1	2											
	PL7-2	3									(3)	(3) (6)	
TSX 172 3428 TSX 172 3444	PL7-1	2											
TSX 17B 1428 (5)	PL7-2	3						(4)		(2)	(3)	(3) (6) (7)	
TSX 172 4012	PL7-1	2											
	PL7-2	3									(3)	(3) (6) (7)	

- Combination possible
- Combination not possible

- (1) Excluding TSX 17 ACC5 UNI-TELWAY adaptor module and TSX FPG 10 FIPIO bus/FIPWAY network module.
- (2) The  $\pm$  24 V sensor power supply provided by the PLC base or an extension block can only supply one extension module. An external  $\pm$  24 V power supply must be provided when several extension modules are used.
- (3) For a language cartridge version < 5.1, one TSX 17 ACC 5 or TSX FPG 10 module is permitted per TSX 17-20 configuration is authorised.
- (4) The maximum number of TSX DSF 635 modules is limited to 2.
- (5) The TSX 17B 1428 micro-PLC is used with PL7-2 language.
- (6) The TSX FPG 10 FIPWAY network module must always be the last extension module.
- (7) With a maximum of a 34 or 40 I/O block or a TSX SCG 11●1 module and two 6 or 8 I/O modules.

### Layout

Starting from the PLC base (address 0), discrete or analogue modules and blocks can be added in any order. The last extension block or module must be fitted with a **TSX 17 ACC10** end of line adaptor.

#### Extension blocks

A block with address n is connected to a block or module with address n-1 using a 0.32, 0.90 or 1.6 m cable depending on location. The total length of the cable should not exceed 2.20 m).

#### Discrete, analogue and communication extension modules

A block with address n is connected to a block or module with address n-1 using a cable which is incorporated in the module. Module with address n is therefore always located to the right of the block or module whose address is n-1.

#### TSX 17-20 micro-PLC layout examples (in PL7-2 language)

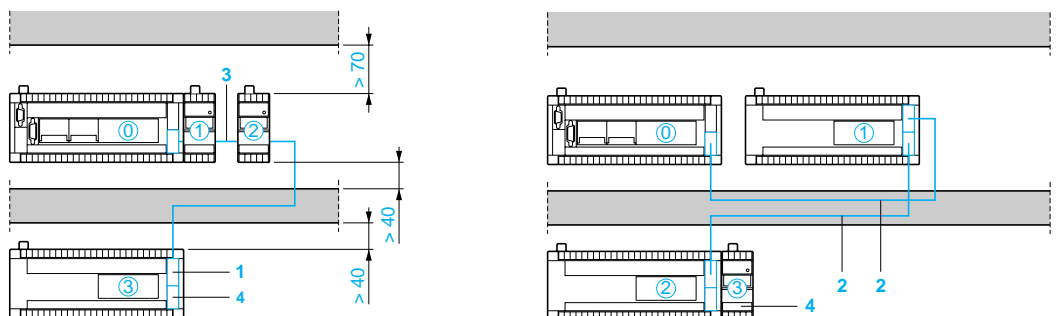

- 1 TSX CBB 003 connecting cable, length 0.32 m.
- 2 TSX CBB 009 connecting cable, length 0.90 m.
- 3 Cable built into extension module.
- 4 TSX 17 ACC 10 end of line adaptor.

# TSX 17 micro-PLCs

## TSX 17-10/20 micro-PLCs

Composition :  
 Pages 41101/2 and 41101/3  
 References, dimensions :  
 Pages 41101/10 and 41101/11  
 Connections :  
 Pages 41101/12 to 41101/15

### Characteristics

#### Environment

<b>Temperature</b>	Operating + 5...+ 55 °C, storage - 25...+ 70 °C
<b>Altitude</b>	0...2000 m
<b>Degree of protection</b>	IP 20 conforming to IEC 664 and NF C 20040

#### Power supply characteristics

		~ 110...240 V TSX 171●●/172●● TSX DMF 242A/3●●A	≡ 24 V TSX 171●● TSX DMF 400	≡ 24 V TSX 172●● TSX DMF 401
<b>PLC bases</b>				
<b>Extension blocks and modules</b>				
<b>Supply voltage</b>	Nominal	~ 110...240 V	≡ 24 V	≡ 24 V
	Limit	~ 90...264 V	≡ 19.2...30 V (1)	≡ 19.2...30 V (1)
<b>Frequency</b>	Nominal	50/60 Hz	–	–
	Limit	47...63 Hz	–	–
<b>Power required</b>	PLC	42 VA	21 W	28 W
	Extension	31 VA	5 W	3 W
<b>Protected sensor power supply</b>		≡ 24 V/0.25 A	–	–
<b>Primary/earth isolation</b>		1500 V rms, 50 Hz	None	1500 V rms, 50 Hz
<b>Conforms to standard IEC 65A</b>		Yes	Yes	Yes

#### Input characteristics (2)

		Isolated inputs ≡ 24 V TSX 171●●/172●● TSX DMF 242A/342A/401	Non-isolated inputs ≡ 24 V TSX 171●● TSX DMF 400	Inputs ~ 110 V TSX 172●● TSX DMF 344A/DEF 804	Isolated inputs ≡ 24 V TSX DEF 812	
<b>PLC bases</b>						
<b>Extension blocks and modules</b>						
<b>Type of inputs</b>		Isolated	Non-isolated	Isolated	Isolated	
<b>Nominal input values</b>	Voltage	≡ 24 V	≡ 24 V	~ 110 V (47...63 Hz)	≡ 24 V	
	Current	7 mA	7 mA	15 mA	15 mA	
<b>Sensor power supply</b>		≡ 19.2...30 V (1)	≡ 19.2...30 V (1)	~ 88...132 V	≡ 19.2...30 V (1)	
<b>Logic</b>		Positive	Positive	–	Positive	
<b>Display of each input</b>		On PLC	On PLC	On PLC	On PLC	
<b>Sensors commoned</b>		To + 24 V of sensor power supply (3)	To + 24 V of power supply	–	To + 24 V of power supply	
<b>Input limit values</b>	At state 1	Voltage	11 V	11 V	74 V	
		Current	2.5 mA for U = 11 V	2.5 mA for U = 11 V	6 mA for U = 74 V	6 mA
	At state 0	Voltage	5 V	5 V	20 V	5 V
		Current	1.4 mA	1.4 mA	4 mA	3 mA
<b>Input impedance</b>		3.2...3.7 k	3.2...3.7 k	5.8...9.5 k	1.5...1.7 k	
<b>Response times</b>	From state 0 to 1	4.5...12 ms	4.5...12 ms	5...33 ms	6...18 ms	
	From state 1 to 0	4.5...12 ms	4.5...12 ms	11...50 ms	4...13 ms	
<b>Power dissipation per point at 1</b>		0.17 W	0.17 W	0.2 W	0.35 W	
<b>External line</b>	Line resistance	500	500	1k	500	
	Leakage resistance	30 k	30 k	30 k	30 k	
<b>Isolation</b>	Between inputs and bus	10 M at ≡ 500 V	None	1500 V rms, 50/60 Hz	10 M at ≡ 500 V	
	Type	Opto-coupler	–	Opto-coupler	Opto-coupler	
<b>Conforms to standard IEC 1131</b>		Type 1	Type 1	Type 2	Type 2	
<b>Compatible with Telemecanique 2 and 3-wire sensors</b>		Yes	Yes	2 wire ~ 110 V	Yes	

#### Characteristics of event-triggered and fast counter inputs (2)

		Event-triggered	Fast counter	
<b>Inputs</b>				
<b>Nominal values</b>	Voltage	≡ 24 V	≡ 24 V	≡ 5 V
	Current	15 mA	15 mA	38 mA
<b>Input limit values</b>	At state 1	Voltage	11 V	2 V
		Current	6 mA for U = 11 V	6 mA for U = 11 V
	At state 0	Voltage	5 V	1 V
		Current	3 mA	3 mA
<b>Immunity</b>	From state 0 to 1	0.15...1 ms	Maximum frequency permitted	
	From state 1 to 0	0.3...1 ms	2 kHz	
<b>Isolation</b>	Between inputs and bus	10 M at ≡ 500 V	–	–
	Type	Opto-coupler	–	–
<b>Conforms to standard IEC 65A</b>		Class 2	Class 2	–
<b>Compatible with Telemecanique 2 and 3-wire sensors</b>		Yes	Yes	–

(1) Ripple included.

(2) Input characteristics are given for a load rate of 60 % (number of inputs simultaneously at state 1 in relation to total number of inputs).

(3) Except **TSX DMF 401** : sensors commoned to + 24 V of power supply.

# TSX 17 micro-PLCs

## TSX 17-10/20 micro-PLCs

Composition :  
 Pages 41101/2 and 41101/3  
 References, dimensions :  
 Pages 41101/10 and 41101/11  
 Connections :  
 Pages 41101/12 to 41101/15

### Characteristics

#### Characteristics of relay outputs (1)

<b>PLC bases</b>	<b>TSX 171 2028, TSX 171 2028/3428, TSX 172 2028/2044/3428/3444</b>	
<b>Extension blocks and modules</b>	<b>TSX DMF 242A/342A/344A, TSX DSF 635</b>	
<b>Type of outputs</b>	Relay, 1 N/O contact per channel	
<b>A.c. loads</b>	Voltage	~ 24...240 V
	Permitted power for AC-11 operation	9 VA with 48 V U 240 V for 10 x 10 <sup>6</sup> operating cycles 25 VA with 24 V U 48 V for 2 x 10 <sup>6</sup> operating cycles 50 VA with 110 V U 240 V for 1 x 10 <sup>6</sup> operating cycles
<b>D.c. loads</b>	Voltage	24 V
	Permitted power for DC-11 operation	10 W with U = 24 V for 1 x 10 <sup>6</sup> operating cycles
<b>Display of each output</b>	On PLC	
<b>Thermal current</b>	3 A	
<b>Leakage current at state 0</b>	1 mA at 220 V, 50 Hz	
<b>Response times</b>	Change from state 0 to 1	10 ms
	Change from state 1 to 0	20 ms
<b>Isolation</b>	Between outputs	1500 V rms, 50/60 Hz
	Between outputs and bus	1500 V rms, 50/60 Hz
	Type	Relay
<b>Built-in protection</b>	Against ~ inductive overvoltages	MOV (ZNO) peak limiter on each output
<b>Recommended external protection</b>	Against short-circuits and overloads	1 quick blow fuse of less than 3 A on each output
	Against --- inductive overvoltages	Flywheel diode across load
<b>Compatible with TSX 17 PLC inputs, --- 24 V</b>	Yes	

#### Characteristics of transistor outputs (1)

<b>PLC bases</b>	<b>TSX 171 2002, TSX 171 2002, TSX 171 4002</b>	<b>TSX 172 2012, TSX 172 4012</b>
<b>Extension blocks and modules</b>	<b>TSX DMF 400</b>	<b>TSX DMF 401, TSX DSF 612</b>
<b>Type of outputs</b>	Transistor, non protected	Transistor, protected
<b>D.c. loads</b>	Nominal voltage	--- 24 V
	Nominal current	0.35 A at 55 °C ; 0.5 A at 25 °C
	Nominal current with 2 outputs in parallel	0.63 A at 55 °C ; 0.9 A at 25 °C
	Tungsten filament lamp	10 W
<b>Logic</b>	Positive	Positive
<b>Display of each output</b>	On PLC	On PLC
<b>Loads commoned</b>	To "—" of power supply	To "—" of power supply
<b>Limit values</b>	Voltage	--- 19.2...30 V (4)
<b>Leakage current at state 0</b>	1 mA	
<b>Residual voltage at state 1 for nominal current</b>	0.5 V	1.3 V
<b>Response times</b>	Change from state 0 to 1	100 µs
	Change from state 1 to 0	200 µs
<b>Isolation</b>	Between outputs and bus	10 M at --- 500 V
	Type	Opto-coupler
<b>Built-in protection</b>	Against short-circuits and overloads	Thermal protection (reset automatically or by switching off the actuator voltage)
	Against inductive overvoltages	Yes
<b>Compatible with TSX 17 PLC inputs, --- 24 V</b>	Yes	Yes
<b>Conforms to standard IEC 65</b>	Yes	Yes
<b>Fast outputs equipped with Zener diode discharge circuit</b>	All	Outputs 00 and 01

- (1) Output characteristics are given for a load rate of 60 % (number of outputs simultaneously at state 1 in relation to total number of outputs).  
 (2) Outputs : 0 to 3 on TSX 171 4002 and TSX DMF 400 ; 0 and 1 on TSX 171 2002 and TSX 171 2002.  
 (3) Outputs : 4 to 15 on TSX 171 4002 and TSX DMF 400 ; 2 to 7 on TSX 171 2002 and TSX 171 2002.  
 (4) Ripple included.



# TSX 17 micro-PLCs

## TSX 17-10/20 micro-PLCs

Composition :  
 Pages 41101/2 and 41101/3  
 References, dimensions :  
 Pages 41101/10 and 41101/11  
 Connections :  
 Pages 41101/12 to 41101/15

### Characteristics

#### Characteristics of triac outputs (1)

<b>Extension module</b>	<b>TSX DSF 604</b>	
<b>Type of outputs</b>	Triac	
<b>A.C. loads</b>	Type	Inductive
	Nominal voltage	110 V-120 V
	Nominal current/output	1 A (2)
	Nominal frequency	50/60 Hz
<b>Display of each output</b>	On PLC	
<b>Limit values</b>	Voltage	93.5...132 V
	Peak current when switched on	10 A on 2 repetitive cycles once per second
	Total load in module	3 A max (2)
	Frequency	47...63 Hz
<b>Response times</b>	Change from state 0 to 1	1/2 period + 0.5 ms
	Change from state 1 to 0	1/2 period
<b>Leakage current at state 0</b>	3 mA	
<b>Residual voltage at state 1</b>	I nominal > 50 mA	3 V
	25 mA < I nominal < 50 mA	13 V
<b>Built-in protection</b>	Against inductive overvoltages	MOV (ZNO) peak limiter and RC suppressor
<b>External protection recommended</b>	Against short-circuits and overloads	1 quick blow fuse : rating 3.15 A on each output
<b>Compatible with</b>	~ 110 V Series 7 PLC inputs	Yes
<b>Conforms to standards</b>	IEC 65A-NF C 63850-UL-CSA	
<b>Isolation</b>	Between groups of outputs	1500 V rms, 50/60 Hz
	Between outputs and bus	1500 V rms, 50/60 Hz
	Type	Opto-coupler

#### Characteristics of analogue timer module

<b>Analogue timer module</b>	<b>TSX DTF 400</b>		
<b>Values</b>	<b>Minimum</b>	<b>Maximum</b>	
<b>Delay time with internal potentiometer</b>	Range 1	0.1 s	1 s
	Range 2	0.15 s	1.5 s
	Range 3	1 s	10 s
	Range 4	10 s	100 s
<b>Delay time with external 1 M potentiometer</b>	Range 1 (3)	0.1 s	6 s
	Range 2 (3)	0.15 s	9 s
	Range 3 (3)	1 s	60 s
	Range 4 (3)	10 s	600 s
<b>Internal potentiometer</b>	0	220 k	
<b>External potentiometer</b>	Value	0	1 M
<b>Power</b>	0.5 W	-	
<b>Connecting cable</b>	-	5 m screened	
<b>Temperature drift (with internal potentiometer)</b>	-	3 %	

(1) Output characteristics are given for a load rate of 60 % (number of outputs simultaneously at state 1 in relation to total number of outputs).

(2) Temperature derating if  $\theta_A > 40$  °C:

- per output:  $0.017 \text{ A/}^\circ\text{C}$  ; in module:  $0.07 \text{ A/}^\circ\text{C}$ ,
- I/output =  $1 - 0.017 \times (\theta_A - 40)$  ; I/module =  $3 - 0.07 \times (\theta_A - 40)$ .

(3) Minimum values with internal potentiometer at 0. Maximum values with internal potentiometer at 220 k .

(4) With linear variation.

# TSX 17 micro-PLCs

## TSX 17-10/20 micro-PLCs

Composition :  
 Pages 41101/2 and 41101/3  
 Characteristics :  
 Pages 41101/7 to 41101/9  
 Connections :  
 Pages 41101/12 to 41101/15

## References

### TSX 17-10 micro-PLCs (1)

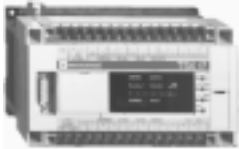

TSX 171 2028E

Power supply	No. of I/O	No. of inputs = 24 V	No. of outputs	Reference (2)	Weight kg
~ 110...240 V	20	12 isolated	8 relay	<b>TSX 171 2028E</b>	1.590
	34	22 isolated	12 relay	<b>TSX 171 3428E</b>	1.690
= 24 V	20	12 non-isolated	8 transistor (3)	<b>TSX 171 2002E</b>	1.610
	40	24 non-isolated	16 transistor (3)	<b>TSX 171 4002E</b>	2.080

### TSX 17-20 micro-PLCs (1) (4)



TSX 172 4012E

Power supply	No. of I/O (5)	No. of inputs isolated	No. of outputs	Reference (2)	Weight kg
~ 110...240 V	20	12 = 24 V	8 relay	<b>TSX 172 2028E</b>	1.620
		12 ~ 110 V	8 relay	<b>TSX 172 2044E</b>	1.620
	34	22 = 24 V	12 relay	<b>TSX 172 3428E</b>	1.690
		22 ~ 110 V	12 relay	<b>TSX 172 3444E</b>	1.690
= 24 V	20	12 = 24 V	8 transistor (6)	<b>TSX 172 2012E</b>	1.610
	40	24 = 24 V	16 transistor (6)	<b>TSX 172 4012E</b>	2.080

### PL7-2 language cartridges for TSX 17-20



TSX MC70 E

Extension module management	Discrete I/O	Intelligent I/O	Comm.	Communi- cation via terminal port	Real-time clock	Reference	Weight kg
TSX DMF/DSF	TSX AEG/ASG	TSX SCG					
TSX DEF/DTF	TSX 17 ACC 5	TSX FPG					
Yes	No	No	No	No	No	<b>TSX P17 20F</b>	0.040
	Yes	No	Yes	No	No	<b>TSX P17 20FA</b>	0.040
		Yes	Yes	Yes	Yes	<b>TSX P17 20FB</b>	0.030
				No	No	<b>TSX P17 20FC2</b>	0.040
				Yes	Yes	<b>TSX P17 20FD2</b>	0.040

### Memory cartridges



TSX DTF 400

Description	Type	Capacity	Reference	Weight kg
<b>Program memory backup</b>	EEPROM	8 K bytes	<b>TSX MC70 E38</b>	0.040
		24 K bytes	<b>TSX MC70 E324</b>	0.040
	EPROM	8 K bytes	<b>TSX MC70 E48 (7)</b>	0.040
		24 K bytes	<b>TSX MC70 E424 (7)</b>	0.040

### Analogue timer module



TSX DMF 401

Description	Potentiometer	Time/channel ranges (in seconds)				Reference	Weight kg
		Range 1	Range 2	Range 3	Range 4		
<b>Analogue timer</b>	Internal	0.1...1	0.15...1.5	1...10	10...100	<b>TSX DTF 400</b>	0.490
	External	0.1...6	0.15...9	1...60	10...600		

### Discrete I/O extensions



TSX DEF 800

Description	Power supply	No. of inputs	No. of outputs	Reference	Weight kg
<b>Extension block</b>	~ 110...240 V	8 = 24 V isolated	16 relay	<b>TSX DMF 242A</b>	1.500
		22 = 24 V isolated	12 relay	<b>TSX DMF 342A</b>	1.440
		22 ~ 110 V isolated	12 relay	<b>TSX DMF 344A</b>	1.440
	= 24 V	24 = 24 V non-isolated	16 transistor (3)	<b>TSX DMF 400</b>	1.680
		24 = 24 V isolated	16 transistor (6)	<b>TSX DMF 401</b>	1.680
<b>Extension module</b>	PLC base	8 = 24 V isolated	–	<b>TSX DEF 812</b>	0.440
		8 ~ 110 V isolated	–	<b>TSX DEF 804</b>	0.300
		–	6 relay	<b>TSX DSF 635</b>	0.500
		–	6 transistor (6)	<b>TSX DSF 612</b>	0.500
		–	6 triac	<b>TSX DSF 604</b>	0.500

(1) PL7-1 application development software and diagnostic, see pages 46502/5 and 46200/2.

(2) The letter **E** at end of a reference indicates that the product includes documentation in English.

(3) Outputs not isolated or protected against short-circuits (only use block TSX DMF 400 with TSX 171 2002 or TSX 171 4002 PLCs).

(4) PL7-2 application development software and diagnostic, see pages 46503/5 and 46200/2.

(5) Not including 2 event-triggered inputs and 1 fast counter.

(6) Outputs isolated and protected against short-circuits.

(7) Cannot be programmed with TSX T407 V < 3.4 terminal and with TSX TPE 030 1 V < 3.0 cartridge programmer.

# TSX 17 micro-PLCs

## TSX 17-10/20 micro-PLCs

### References, dimensions, mounting

#### Separate parts

Description	Use	Reference	Weight kg	
<b>Lithium battery</b>	For RAM memory backup (program and data)	<b>TSX 17 ACC 1</b>	0.020	
<b>PL7-2 numerical display</b>	For TSX 17-20	<b>TSX 17 ACC 2</b>	0.100	
<b>Adaptor</b>	For end of line (must be fitted to last extension block/module or intelligent module)	<b>TSX 17 ACC 10</b>	0.020	
<b>Connecting cables</b>	For extension block	length 0.32 m	<b>TSX CBB 003</b>	0.110
		length 0.90 m	<b>TSX CBB 009</b>	0.180
		length 1.60 m	<b>TSX CBB 016</b>	0.250
<b>Connecting cable</b>	For fast counting	length 2 m	<b>TSX CCB 020</b>	0.220
<b>Simulator blocks</b>	15 terminals for 12 inputs (1)	<b>TSX 17 ACC 3</b>	0.290	
	24 terminals for 22 inputs	<b>TSX 17 ACC 4</b>	0.350	

#### Documentation (in English)

Description	Manual format	Included in product	Reference	Weight kg
<b>TSX 17 micro-PLC installation</b>	A5 bound	TSX 171●●●● TSX 172●●●●	<b>TSX D11 000E</b>	0.090
<b>BatiBUS protocol installation</b>	A5 bound	TSX 17 B1428E	<b>TSX DM 17 BTB E</b>	0.120
<b>Timer and analogue I/O module installation</b>	A5 bound	TSX L PL7●V5E TXT CD PL7 22 V6E	<b>TSX D12 0005E</b>	0.060
<b>Character string module installation</b>	A5 bound	TSX SCG 1131	<b>TSX D24 010E</b>	0.110
<b>UNI-TELWAY bus installation</b>	-	-	See page 42702/7	-
<b>TSX technical manual</b>	CD-ROM	To be ordered separately	<b>TSX CD D MTE 01E</b>	0.120



TSX CD D MTE 01E

(1) Terminal not compatible with TSX 17-20 micro-PLCs with 20 I/O (TSX 172 2012/2028/2044).

#### Dimensions, mounting

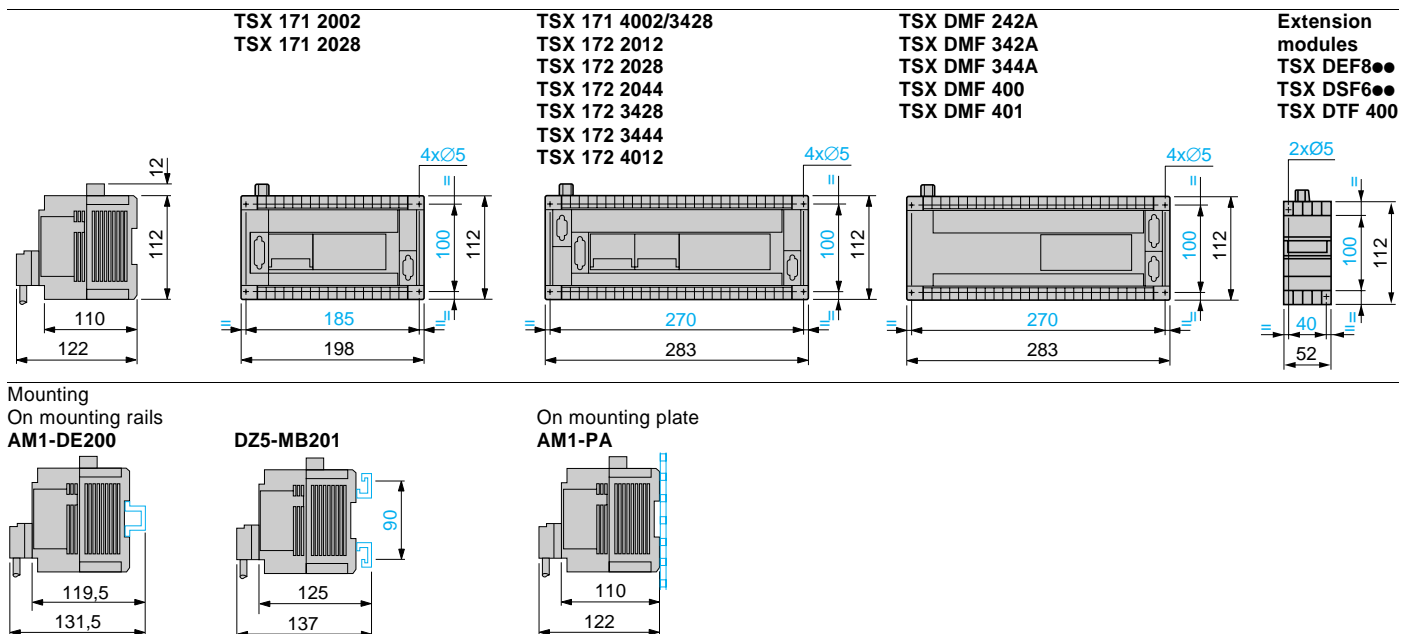

# TSX 17 micro-PLCs

## TSX 17-10/20 micro-PLCs

Composition :  
 Pages 41101/2 and 41101/3  
 Characteristics :  
 Pages 41101/7 to 41101/9  
 References, dimensions :  
 Pages 41101/10 and 41101/11

### Connections

#### TSX 171 2028 PLC

~ 110...240 V power supply  
 12 isolated inputs = 24 V  
 8 relay outputs

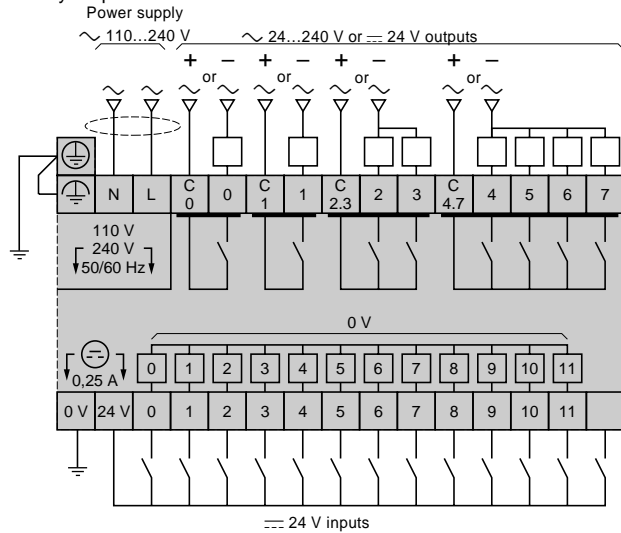

#### TSX 171 2002 PLC

= 24 V power supply  
 12 non isolated inputs = 24 V  
 8 non isolated, non protected transistor outputs (1)

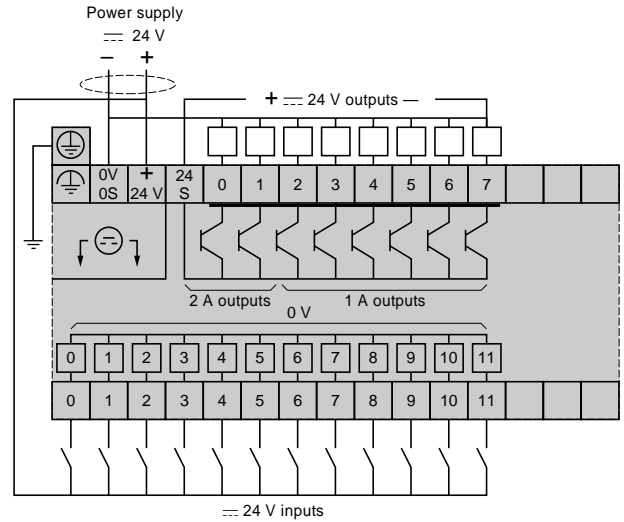

#### TSX 172 2028/172 3428 PLCs

~ 110...240 V power supply, 12 (or 22) = 24 V isolated inputs, 8 (or 12) relay outputs

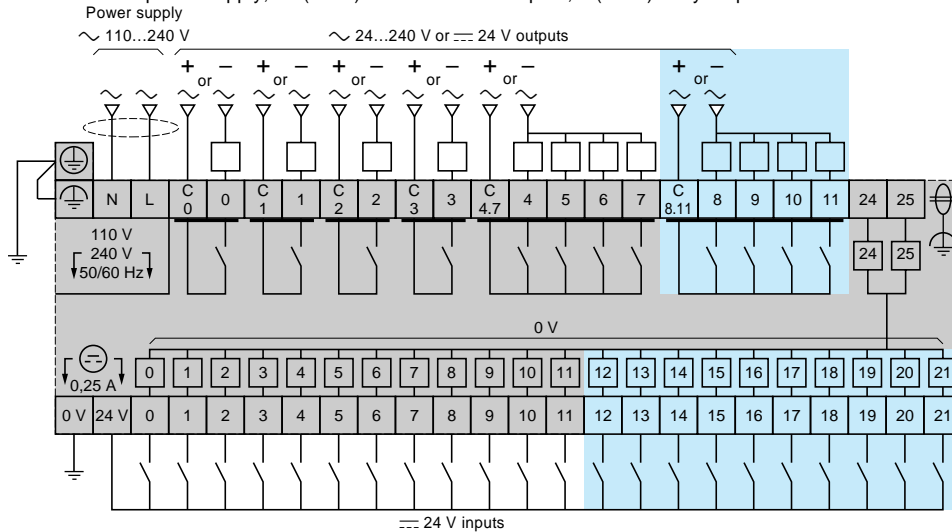

#### TSX 171 4002 PLC and TSX DMF 400 extension block

= 24 V power supply, 24 = 24 V non isolated inputs, 16 non isolated, non protected transistor outputs (1)

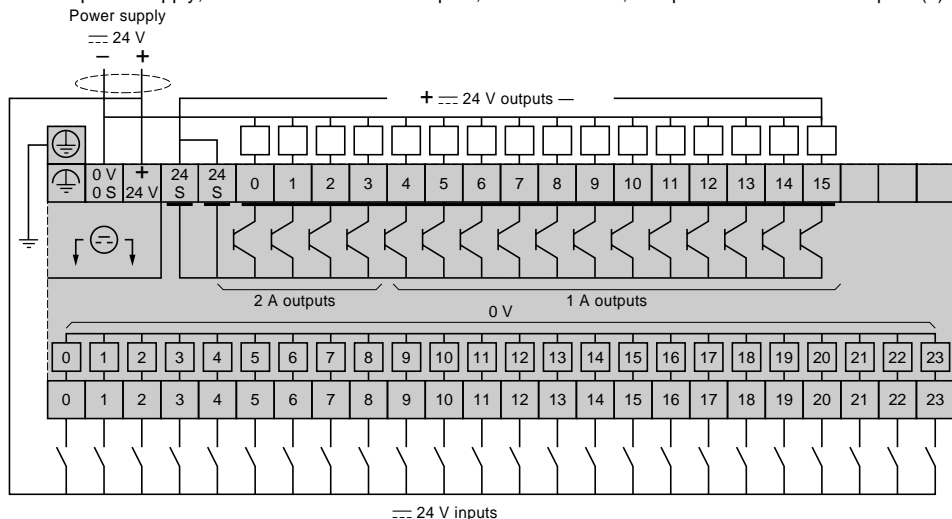

(1) For outputs not protected against short-circuits, fit a fuse in series with each load.

# TSX 17 micro-PLCs

## TSX 17-10/20 micro-PLCs

Composition :  
 Pages 41101/2 and 41101/3  
 Characteristics :  
 Pages 41101/7 to 41101/9  
 References, dimensions :  
 Pages 41101/10 and 41101/11

### Connections

#### TSX DMF 401 extension block

--- 24 V power supply, 24 isolated inputs --- 24 V, 16 isolated and protected transistor outputs

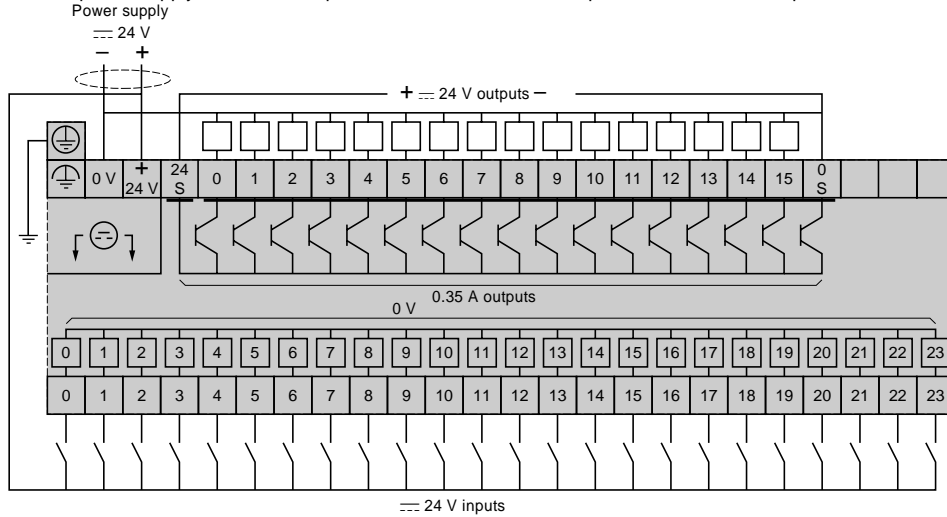

#### TSX 172 2044 PLC

~ 110...240 V power supply, 12 isolated inputs ~ 110 V, 8 relay outputs

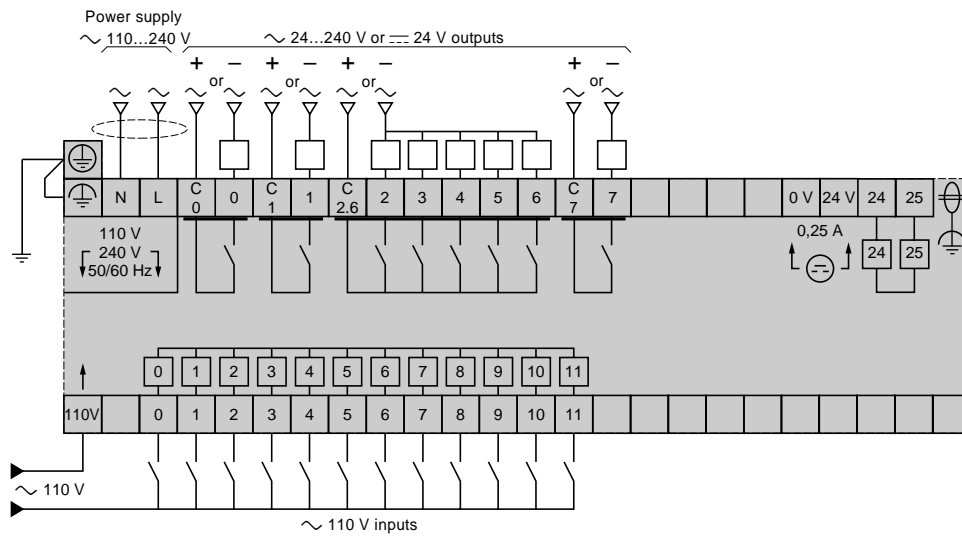

#### TSX 172 3444 PLC

~ 110...240 V power supply, 22 isolated inputs ~ 110 V, 12 relay outputs

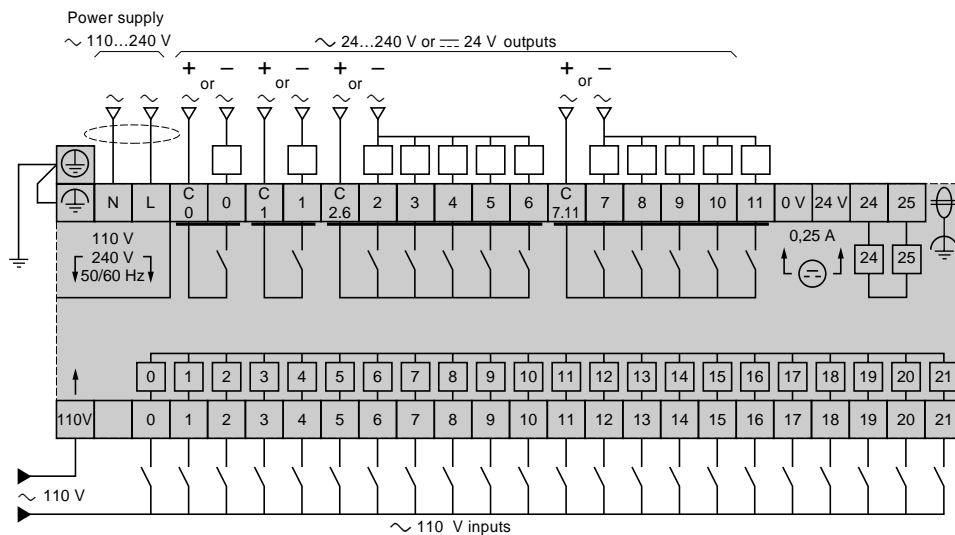



## Artisan Technology Group is your source for quality new and certified-used/pre-owned equipment

- FAST SHIPPING AND DELIVERY
- TENS OF THOUSANDS OF IN-STOCK ITEMS
- EQUIPMENT DEMOS
- HUNDREDS OF MANUFACTURERS SUPPORTED
- LEASING/MONTHLY RENTALS
- ITAR CERTIFIED SECURE ASSET SOLUTIONS

### SERVICE CENTER REPAIRS

Experienced engineers and technicians on staff at our full-service, in-house repair center

### *InstraView*<sup>SM</sup> REMOTE INSPECTION

Remotely inspect equipment before purchasing with our interactive website at [www.instraview.com](http://www.instraview.com) ↗

### WE BUY USED EQUIPMENT

Sell your excess, underutilized, and idle used equipment. We also offer credit for buy-backs and trade-ins. [www.artisanng.com/WeBuyEquipment](http://www.artisanng.com/WeBuyEquipment) ↗

### LOOKING FOR MORE INFORMATION?

Visit us on the web at [www.artisanng.com](http://www.artisanng.com) ↗ for more information on price quotations, drivers, technical specifications, manuals, and documentation

**Contact us:** (888) 88-SOURCE | [sales@artisanng.com](mailto:sales@artisanng.com) | [www.artisanng.com](http://www.artisanng.com)