



Artisan Technology Group is your source for quality new and certified-used/pre-owned equipment

- FAST SHIPPING AND DELIVERY
- TENS OF THOUSANDS OF IN-STOCK ITEMS
- EQUIPMENT DEMOS
- HUNDREDS OF MANUFACTURERS SUPPORTED
- LEASING/MONTHLY RENTALS
- ITAR CERTIFIED SECURE ASSET SOLUTIONS

SERVICE CENTER REPAIRS

Experienced engineers and technicians on staff at our full-service, in-house repair center

*InstraView*SM REMOTE INSPECTION

Remotely inspect equipment before purchasing with our interactive website at www.instraview.com ↗

WE BUY USED EQUIPMENT

Sell your excess, underutilized, and idle used equipment. We also offer credit for buy-backs and trade-ins. www.artisanng.com/WeBuyEquipment ↗

LOOKING FOR MORE INFORMATION?

Visit us on the web at www.artisanng.com ↗ for more information on price quotations, drivers, technical specifications, manuals, and documentation

Contact us: (888) 88-SOURCE | sales@artisanng.com | www.artisanng.com

Thermo Scientific NESLAB HX Series Recirculating Chiller

Thermo Scientific Manual P/N U00506 Rev. 03/26/08

Installation Operation Basic Maintenance



Visit our Web site at:

<http://www.thermofisher.com/tc>

Product Service Information, Applications
Notes, MSDS Forms, e-mail.

Voice Info: (800) 258-0830

Thermo Fisher Scientific

25 Nimble Hill Road
Newington, NH 03801
Tel : (800) 258-0830 or
(603) 436-9444
Fax : (603) 436-8411
www.thermofisher.com/tc

Sales, Service, and Customer Support

25 Nimble Hill Road
Newington, NH 03801
Tel: (800) 258-0830
Sales: 8:00 am to 5:00 pm
Service and Support: 8:00 am to 6:00 pm
Monday through Friday (Eastern Time)
Fax: (603) 436-8411
service.tc.us@thermofisher.com

Dieselstrasse 4
D-76227 Karlsruhe, Germany
Tel : +49 (0) 721 4094 444
Fax : +49 (0) 721 4094 300

Building 6, No. 27
Xin Jinqiao Rd., Shanghai 201206
Tel : +86(21) 68654588
Fax : +86(21) 64457830
info.china@thermofisher.com

Statement of Copyright

Copyright © 2008 Thermo Fisher Scientific. All rights reserved.

This manual is copyrighted by Thermo Fisher Scientific.

Users are forbidden to reproduce, republish, redistribute, or resell any materials from this manual in either machine-readable form or any other form.

HX Series Recirculating Chiller Installation and Operation Manual

Table of Contents

PREFACE	
	Compliance 5
	WEEE/RoHS 5
	After-sale Support 6
	Unpacking 7
	Warranty 7
	Feedback 7
SECTION I	
Safety	
	Warnings 8
SECTION II	
General Information	
	Description 9
	Specifications 10
	Cooling Capacity 11
	Pump Capacity 12
SECTION III	
Installation	
	Site (Air-cooled Units) 15
	Site (Water-cooled Units) 17
	Electrical Requirements 19
	Plumbing Requirements 21
	Auto Refill 22
	Fluids 23
	Water Quality Standards and Recommendations 24
	Filling Requirements 25
SECTION IV	
Operation	
	Start Up/Shut Down 27
	Digital Controller 28
	Setpoint 28
	Setup Loop 29
	15-Pin Interface 31
	Flow Control 32
	Pressure Gauge 32

**SECTION VI
Optional Features**

External Pressure Regulator 33
Particulate Filters 34

**SECTION VII
Maintenance**

Service Contracts 35
Condenser Cleaning 35
Hoses 35
Algae 35

**SECTION VIII
Service**

Configuration 37
Reservoir Cleaning 38
Pump Strainer 39
Error Codes 40
Pump Motor Lubrication 41
Phase Rotation 41
High/Low Pressure Cutouts 42
Pump Motor Overload Protector 42
Pressure Relief Valve 43
Refrigeration Data 43

**SECTION IX
Troubleshooting**

Displaying Software Version 45
Checklist 45
Service Assistance 46

**SECTION X
Diagrams**

Refrigeration Flow (HX-75 and HX-150) 47
Refrigeration Flow (HX-300 through HX-750) 47
Pump Flow (CP Pumps) 48
Pump Flow (PD and TU Pumps) 48
Dimensions 49

**SECTION XI
Wetted Materials**

WARRANTY

Quick Start Procedures Air-Cooled Models

Installation

Position the unit so the intake and discharge are not impeded. Inadequate ventilation will cause a reduction in cooling capacity and, in extreme cases, compressor failure.

Avoid excessively dusty areas and institute a periodic cleaning schedule. For proper operation, the unit needs to pull substantial amounts of air through a condenser. A build up of dust or debris on the fins of the condenser will lead to a loss of cooling capacity.

The unit will retain its full rated capacity in ambient temperatures up to approximately +24°C.

Ensure the voltage of the power source meets the specified voltage, $\pm 10\%$.

The plumbing connections are located on the right side of the unit and are labelled SUPPLY and RETURN. These connections are $\frac{3}{4}$ inch FPT, 1 inch FPT for units with a CP-75 or TU-9 pump. Remove the plastic protective plugs from both plumbing connections. Connect the SUPPLY fitting to the inlet of your application. Connect the RETURN fitting to the outlet of your application.

To fill the reservoir open the access panel on the left rear corner of the case top and remove the reservoir cover by unscrewing the thumbscrews. Fill the reservoir to within one inch of the top. If the fluid capacity of your application and recirculation lines is significant, have extra fluid on hand.

Thermo Fisher recommends using distilled/deionized water with a 0.05 to 0.1 MOhmcm reading. If you do not have access to distilled/deionized water we recommend using filtered facility water.

Operation

Before starting the unit, double-check all electrical and plumbing connections. Make sure the circulating system has been filled with cooling fluid.

On models HX 300 through HX 750, the unit must be connected to the power source for at least 12 hours to allow the compressor oil to heat and separated from the refrigerant.

To start the unit first connect it to main power. On units equipped with a circuit breaker, place it to the ON position. The MAIN POWER LED will illuminate. Place the ON/OFF switch to the ON position. The COOL and IDLE LEDs on the front panel indicate the status of the refrigeration system. COOL is on when the unit is removing heat from the cooling fluid, IDLE is on when heat is being added to the fluid reservoir. As the operating temperature approaches the setpoint, the LEDs cycle.

When the unit is shut off, wait five minutes before restarting to allow time for the refrigeration pressures to equalize. If the pressures are not allowed to equalize, the compressor will short-cycle and no cooling will occur.

Temperature Adjustment

To display the temperature setpoint, while displaying the reservoir temperature press the NEXT ENTER key. To adjust the temperature setpoint use the YES/NO keys as described in this manual.

Flow Control

The RECIRCULATING FLOW CONTROL handle controls the flow rate to your application. In the full vertical position you receive full flow, the full horizontal position is no flow.

Periodic Maintenance

Periodically inspect the reservoir fluid. If cleaning is necessary, flush the reservoir with a cleaning fluid compatible with the circulating system and the cooling fluid.

The cooling fluid should be replaced periodically. When operating at low temperatures, the concentration of water in the cooling fluid will increase over time, leading to a loss of cooling capacity.

Periodic vacuuming of the condenser fins is necessary. The frequency of cleaning depends on the operating environment. We recommend making a monthly visual inspection of the condenser after initial installation. After several months, the cleaning frequency will be established.

Units with PD and TU pumps have a strainer. If debris is in the system, the strainer will prevent the material from being drawn into the pump and damaging the pump vanes.

After initial installation, the strainer may become clogged. The strainer must be cleaned after the first week of installation. After this first cleaning, a monthly visual inspection is recommended. After several months, the frequency of cleaning will be established.

Before cleaning the strainer, disconnect the power cord from the power source and drain the reservoir.

Quick Start Procedures Water-Cooled Models

Installation

Position the unit in a clean environment with easy access to facility cooling water and a drain. The facility water requirements must meet those specified in the instruction or unit performance will be reduced.

Ensure the voltage of the power source meets the specified voltage, $\pm 10\%$.

The plumbing connections are located on the rear and right side of the unit and are labelled FACILITY WATER INLET and FACILITY WATER OUTLET, SUPPLY and RETURN. Remove the plastic protective plugs from all the plumbing connections. Connect the FACILITY WATER INLET fitting to the facility cooling water and the FACILITY WATER OUTLET fitting to a drain. Connect the SUPPLY fitting to the inlet of your application and the RETURN fitting to the outlet of your application. On HX 75s through HX 300s, the FACILITY fittings are $\frac{1}{2}$ inch FPT. On HX 500s and HX 750s, these fittings are 1 inch FPT. The SUPPLY and RETURN connections are $\frac{3}{4}$ inch FPT, 1 inch FPT for units with a CP-75 or TU-9 pump.

To fill the reservoir open the access panel on the left rear corner of the case top and remove the reservoir cover by unscrewing the thumbscrews. Fill the reservoir to within one inch of the top. If the fluid capacity of your application and recirculation lines is significant, have extra fluid on hand.

Thermo Fisher recommends using distilled/deionized water with a 0.05 to 0.1 MOhmcm reading. If you do not have access to distilled/deionized water we recommend using filtered facility water.

Operation

Before starting the unit, double-check all electrical and plumbing connections. Make sure the circulating system has been filled with cooling fluid.

Ensure the facility water is turned on.

On models HX 300 through HX 750, the unit must be connected to the power source for at least 12 hours to allow the compressor oil to heat and separated from the refrigerant.

To start the unit first connect it to main power. On units equipped with a circuit breaker, place it to the on position. The MAIN POWER LED will illuminate. Place the ON/OFF switch to the ON position. The COOL and IDLE LEDs on the front panel indicate the status of the refrigeration system. COOL is on when the unit is removing heat from the cooling fluid, IDLE is on when heat is being added to the fluid reservoir. As the operating temperature approaches the setpoint, the LEDs cycle.

When the unit is shut off, wait five minutes before restarting to allow time for the refrigeration pressures to equalize. If the pressures are not allowed to equalize, the compressor will short-cycle and no cooling will occur.

Temperature Adjustment

To display the temperature setpoint, while displaying the reservoir temperature press the NEXT ENTER key. To adjust the temperature setpoint use the YES/NO keys as described in this manual.

Flow Control

The RECIRCULATING FLOW CONTROL handle controls the flow rate to your application. In the full vertical position you receive full flow, the full horizontal position is no flow.

Periodic Maintenance

Periodically inspect the reservoir fluid. If cleaning is necessary, flush the reservoir with a cleaning fluid compatible with the circulating system and the cooling fluid.

The cooling fluid should be replaced periodically. When operating at low temperatures, the concentration of water in the cooling fluid will increase over time, leading to a loss of cooling capacity.

Units with PD and TU pumps have a strainer. If debris is in the system, the strainer will prevent the material from being drawn into the pump and damaging the pump vanes.

After initial installation, the strainer may become clogged. The strainer must be cleaned after the first week of installation. After this first cleaning, a monthly visual inspection is recommended. After several months, the frequency of cleaning will be established.

Before cleaning the strainer, disconnect the power cord from the power source and drain the reservoir.

Preface

Compliance

Products tested and found to be in compliance with the requirements defined in the EMC standards defined by 89/336/EEC as well as Low Voltage Directive (LVD) 73/23/EEC can be identified by the CE Mark on the rear of the unit. The testing has demonstrated compliance with the following directives:

LVD, 73/23/EEC

Complies with IEC/EN61010-1

EMC, 89/336/EEC

IEC/EN61326-1

For any additional information, refer to the Declaration of Conformity that shipped with the unit.

WEEE/RoHS

This product is required to comply with the European Union's Waste Electrical & Electronic Equipment (WEEE) Directive 2002/96/EC. It is marked with the following symbol:



Thermo Fisher Scientific has contracted with one or more recycling/disposal companies in each EU Member State, and this product should be disposed of or recycled through them. Further information on Thermo Fisher Scientific's compliance with these Directives, the recyclers in your country, and information on Thermo Scientific products which may assist the detection of substances subject to the RoHS Directive are available at:

www.thermo.com/WEEERoHS

After-sale Support

Thermo Fisher Scientific is committed to customer service both during and after the sale. If you have questions concerning the operation of your unit or the information in this manual, contact our Sales Department. If your unit fails to operate properly or if you have questions concerning spare parts or Service Contracts, contact our Service Department. See inside front cover for contact information.

Before calling, please refer to the unit's name plate label on the rear of the case top to obtain the following information:

- BOM number
- *Serial number*
- *Software version (see page 45)* _____

Thermo Fisher Scientific			
Newington, NH 03801 U.S.A.			
(800)258-0830 / (603)436-9444			
BOM#: XXXXXXXXXXXX			
S/N: XXXXXXXXXX			
MODEL: HX XXX		PUMP TYPE: XXX	
VOLTS: XX	HZ: XX	PH: X	
MCA: XX	MAX FUSE: XX		
COMPR:	RLA: XX	LRA: XX	
HI: XXX	LO: XX		
CHARGE	X LBS	RXXX	
MOTORS PUMP	XEA	X.XFLA	XHP
FAN	XEA	X.XFLA	
STIRRER	XEA	X.XFLA	

Label (typical)

Unpacking

Retain all cartons and packing material until the unit is operated and found to be in good condition. If the unit shows external or internal damage contact the transportation company and file a damage claim. Under ICC regulations, this is your responsibility.

Out of Box Failure

An Out of Box Failure is defined as any product that fails to operate in conformance with sellers published specifications at initial power up. The unit must be installed in accordance with manufacturer's recommended operating conditions within 30 days of shipment from the seller.

Except for HX 300s, HX 500s, and HX 750s, any Temperature Control product meeting the definition of an Out of Box Failure must be packed and shipped back in the original packaging to Thermo Fisher Scientific for replacement with a new unit; Seller to pay the cost of shipping. Customer must receive a Return Material Authorization (RMA) from Thermo Fisher prior to shipping the unit.

Out of Box Failures for HX 300s, HX 500s, and HX 750s will be repaired at the customer's site; all component parts and labor necessary to perform the repair, as well as travel labor and travel expenses, are the responsibility of the Seller.

Warranty

Units have a warranty against defective parts and workmanship for one full year from date of shipment. See back page for more details.

Feedback

We appreciate any feedback you can give us on this manual. Please e-mail us at neslabmanuals@thermofisher.com. Be sure to include the manual part number and the revision date listed on the front cover.

Section I Safety

Warnings

Make sure you read and understand all instructions and safety precautions listed in this manual before installing or operating your unit. If you have any questions concerning the operation of your unit or the information in this manual, contact our Sales Department for assistance (see Preface, After-sale Support).

Performance of installation, operation, or maintenance procedures other than those described in this manual may result in a hazardous situation and may void the manufacturer's warranty.

Transport the unit with care. Sudden jolts or drops can damage the unit's components.

Do not attempt to defeat any of the interlock switches or safety features built into the unit.

Observe all warning labels.

Never remove warning label.

Never operate damaged or leaking equipment.

Never operate the unit without cooling fluid in the fluid reservoir.

Make sure the unit is off before connecting or disconnecting the power cord or other cables.

Always turn off the unit and, if applicable, disconnect the power cord from the power source before performing any service or maintenance procedures, or before moving the unit.

Always empty the fluid reservoir before moving the unit.

Never operate equipment with damaged power cords.

Refer service and repairs to a qualified Thermo Fisher technician.

In addition to the safety warnings listed above, warnings are posted throughout the manual. These warnings are designated by an exclamation mark inside an equilateral triangle with text highlighted in bold. Read and follow these important instructions. Failure to observe these instructions can result in permanent damage to the unit, significant property damage, or personal injury or death.



The lightning flash with arrow symbol, within an equilateral triangle, is intended to alert the user to the presence of non-insulated "dangerous voltage" within the unit's enclosure. The voltage may be of significant enough magnitude to constitute a risk of electrical shock.



Section II General Information

Description

The Thermo Scientific NESLAB HX Series Recirculating Chillers are designed to provide a continuous flow of cooling fluid at a constant temperature and volume.

Overvoltage Category	II
Pollution Degree	2

The unit consists of an air-cooled or water-cooled refrigeration system, a fluid reservoir, a fluid recirculation pump, and a digital temperature controller. Optional remote temperature controllers and remote probes are also available.

HX units are available with a large number of options. This manual explains how to install, operate, and maintain a “standard” HX unit. This manual also explains some of the available options. Supplemental manuals are supplied with units equipped with options not covered in this manual.

Throughout the manual, you will be asked to consult the unit’s name plate label for specific information. The label is located on the rear or side of the case top.

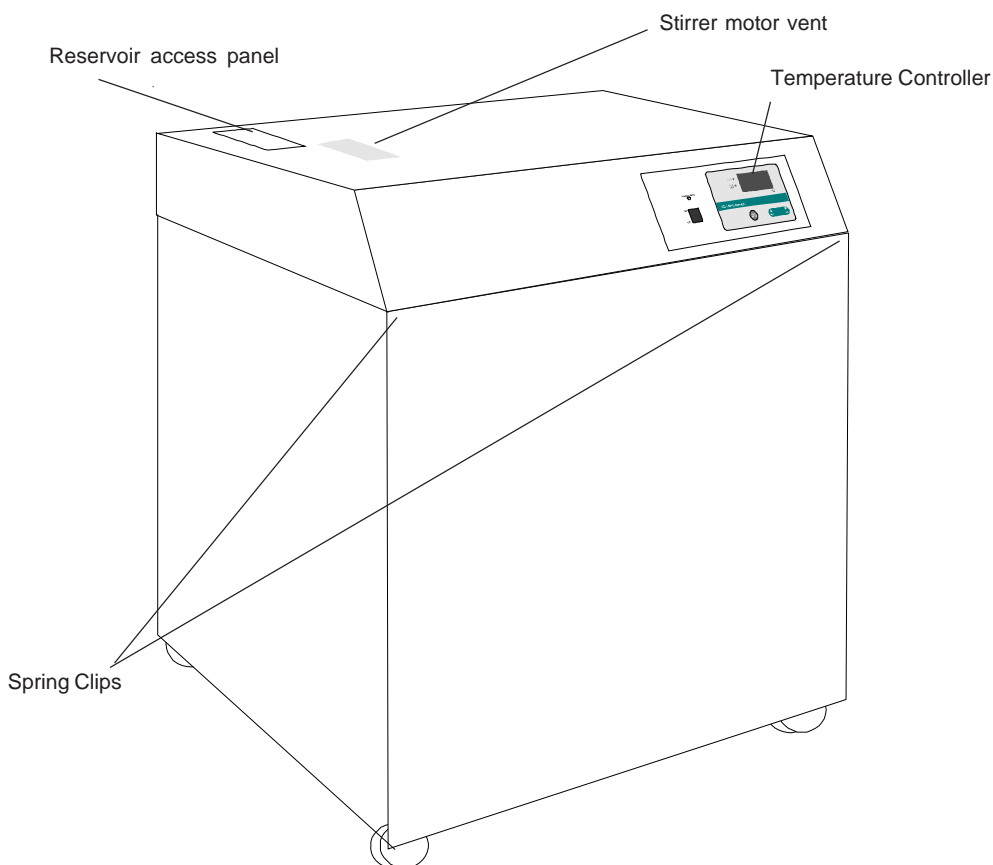

Specifications

	HX 75	HX 150	HX 300
Process Fluid			
Temperature Range¹	+5°C to +35°C		
Temperature Stability	±0.1°C		
Unit Dimensions			
(H x W x D)			
<i>Inches</i>	36 ³ / ₄ x 23 ¹ / ₄ x 18 ³ / ₄	40 ⁵ / ₈ x 26 ¹ / ₄ x 21 ¹ / ₈	46 ⁷ / ₈ x 33 ³ / ₄ x 25 ¹ / ₄
<i>Centimeters</i>	93.3 x 59.0 x 47.6	103.2 x 66.7 x 53.6	119.1 x 85.7 x 64.1
Reservoir Volume			
<i>Gallons</i>	5.0	8.0	15.0
<i>Liters</i>	18.9	30.3	56.8
Refrigerant			
<i>60 Hz</i>	R22	R22	R22
<i>50 Hz</i>	R134A	R134A	R134A
Shipping Weight			
<i>Pounds</i>	261	320	477
<i>Kilograms</i>	118	145	216
	HX 500	HX 750	
Process Fluid			
Temperature Range¹	+5°C to +35°C		
Temperature Stability	±0.1°C		
Unit Dimensions²			
(H x W x D)			
<i>Inches</i>	51 ⁵ / ₈ x 46 x 28 ³ / ₄	64 ³ / ₄ x 46 x 29	
<i>Centimeters</i>	131.1 x 116.8 x 73.0	163.2 x 116.8 x 73.7	
Reservoir Volume			
<i>Gallons</i>	28.0	40.0	
<i>Liters</i>	106.0	151.4	
Refrigerant			
<i>60 Hz</i>	R22	R404A	
<i>50 Hz</i>	R134A	R404A	
Shipping Weight			
<i>Pounds</i>	746	971	
<i>Kilograms</i>	338	440	

1. Modified temperature ranges to -15°C are available.

2. Model HX 750 with a water-cooled refrigeration system has the same dimensions as the HX 500. For additional dimensions see page 49.

3. Thermo Fisher Scientific reserves the right to change specifications without notice.

Cooling Capacity

Cooling capacity will vary depending on fluid temperature, ambient temperature, and cooling fluid.

Cooling capacities were obtained under the following conditions:

1. air-cooled unit operating at +20°C (+68°F) ambient temperature.
2. cooling fluid with specific heat of 1.0 was used for fluid temperatures from +5°C to +35°C.

HX 75 & HX 150

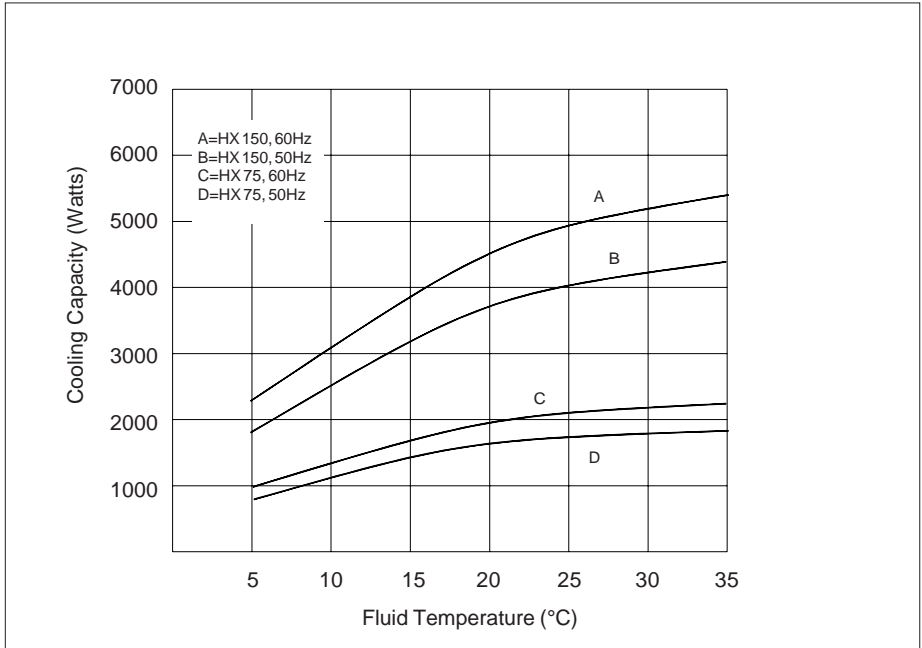

HX 300 & HX 500

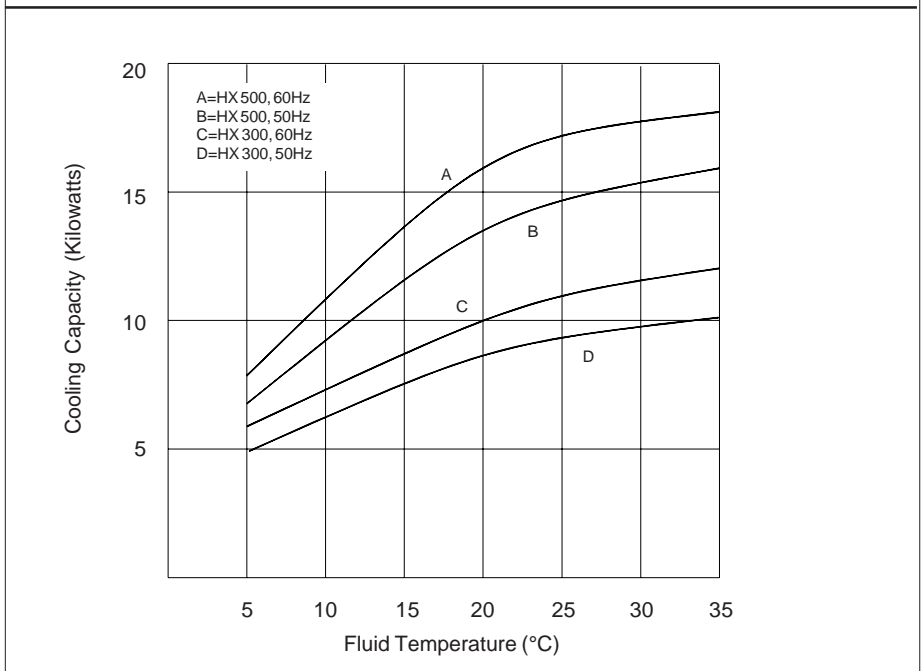

HX 750

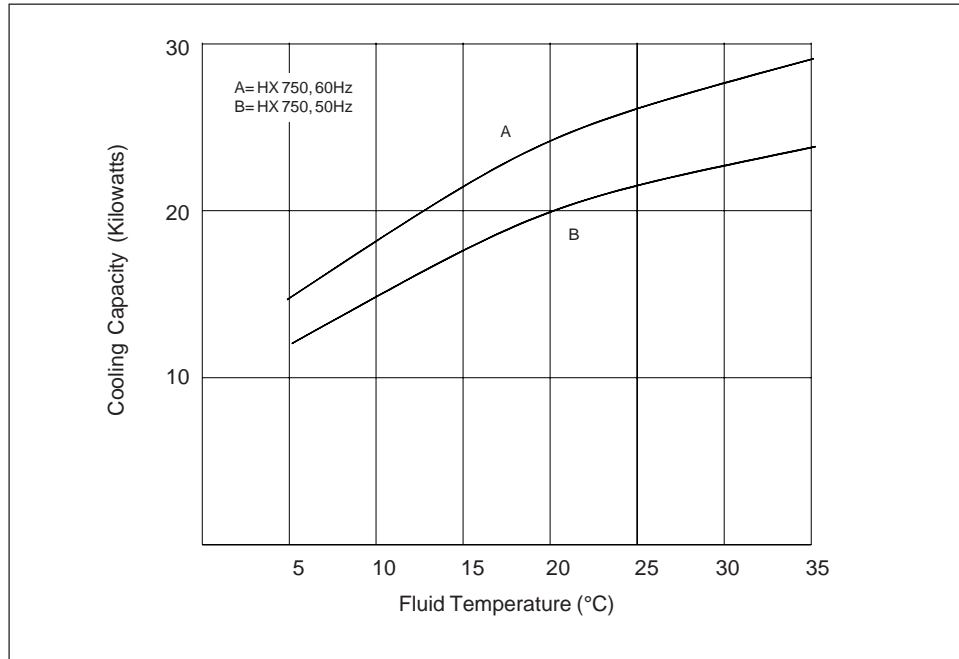

Pump Capacity

HX units are available with one of three standard pump types: positive displacement (PD), centrifugal (CP), and turbine (TU). Refer to the name plate label on the rear of the case top to identify the specific pump in your unit.

PD2 & TU1

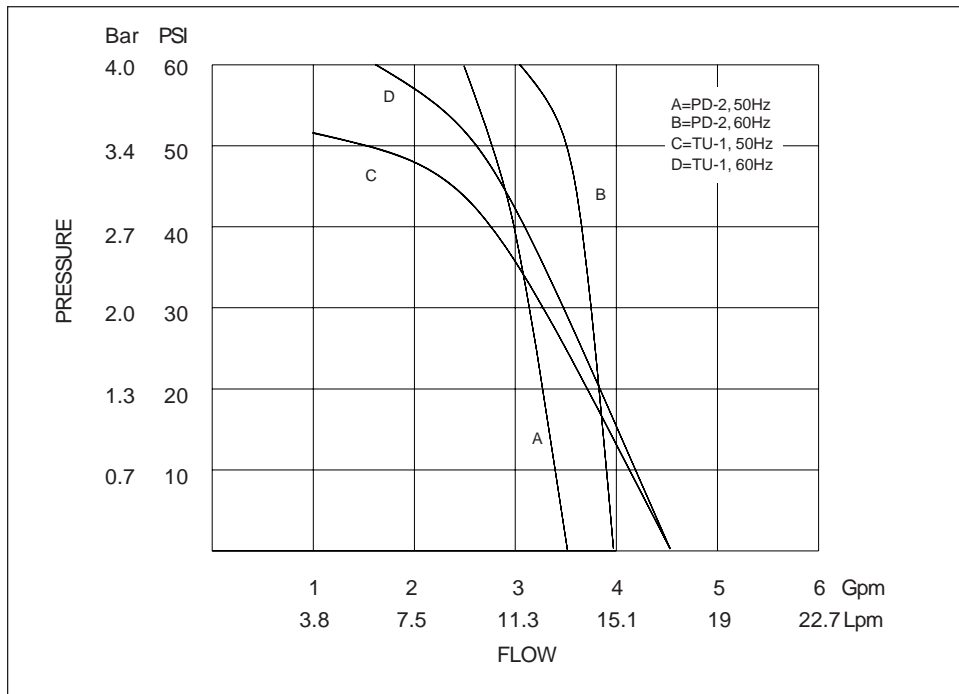

CP

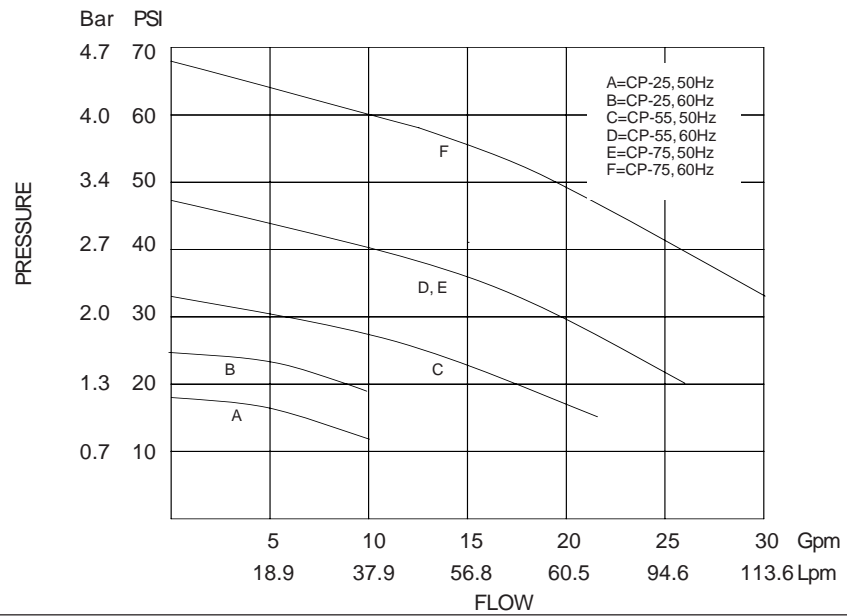

TU-3, 5 & 6

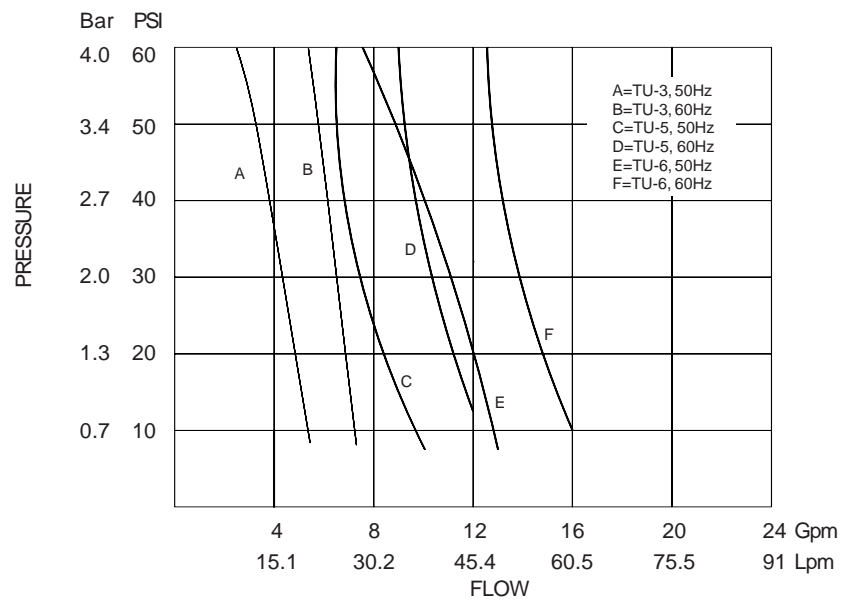

TU-7, 8 & 9

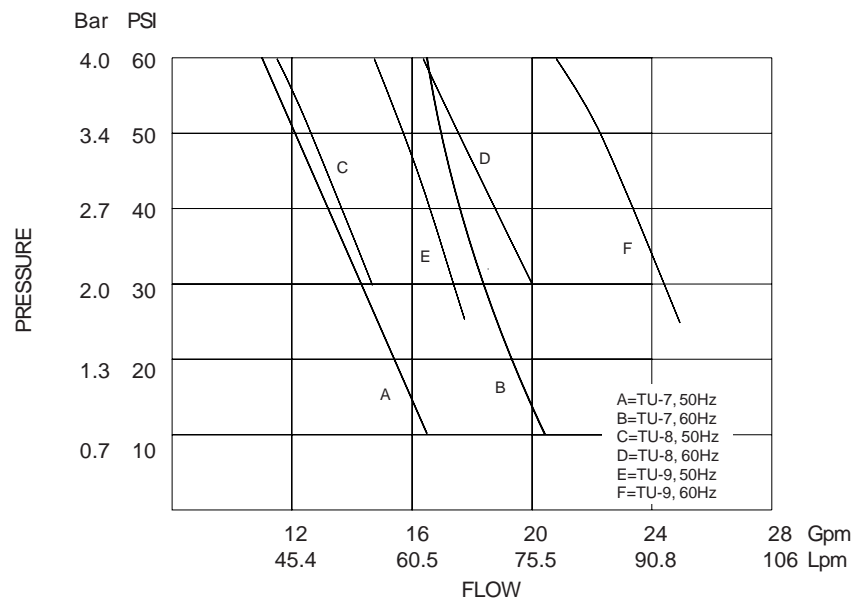

Blank page.

Section III Installation

Site (Air-cooled units)

The unit should be located in a laboratory or clean industrial environment where ambient temperatures are inside the range of +55°F to +95°F (+13°C to +35°C).

The unit will retain its full rated capacity in ambient temperatures to approximately +75°F (+24°C). Reduce the cooling capacity 1% or every 1°F above +75°F, to a maximum ambient temperature of +95°F. In °C, reduce the cooling capacity 1% for every 0.5°C above +24°C, to a maximum ambient temperature of +35°C.



Never place the unit in a location where excessive heat, moisture, or corrosive materials are present.

The unit has an air-cooled refrigeration system. It must be positioned so the air intake and discharge are not impeded.

On models HX 75 and HX 150, air is drawn through the left side of the unit and discharged through the right and rear. A minimum clearance of 2 feet (0.6 meter) on these three sides is necessary for adequate ventilation.

On models HX 300 through HX 750, air is drawn through the front of the unit and discharged through the side and rear panels. A minimum of 5 feet (1.5 meters) on all four sides of the unit is necessary for ventilation.

On models with a three-phase condenser fan motor, it is possible to connect the main power and have the motor turn in the wrong direction resulting in incorrect airflow over the condenser. Proper airflow is achieved by exchanging any two main power connectors so air is drawn into the fan. See page 20.

In some applications where space is at a premium, the minimum ventilation clearance can be compromised. However, consult our Sales Department before positioning the unit in a location with less minimum clearance than listed above. Inadequate ventilation will cause a reduction in cooling capacity and, in extreme cases, compressor failure.



Avoid excessively dusty areas and institute a periodic cleaning schedule (see Section VII, Condenser Cleaning). If the compressor is allowed to overheat the unit's High Pressure Cutout (HPC) will cycle the unit on and off until cleaning is done and proper airflow is restored. This cycling will eventually damage the unit's compressor.

On models HX 150 through HX 750 a stirrer motor is located under the case top. (Models HX 500 and HX 750 have two stirrer motors.) Heat generated by the stirrer motor is discharged through vents in the case top. Do not block the vents. A minimum clearance of 2 inches (5 centimeters) is necessary for adequate ventilation.

NOTE: HX 75s and units with plate heat exchangers do not have stirrer motors.

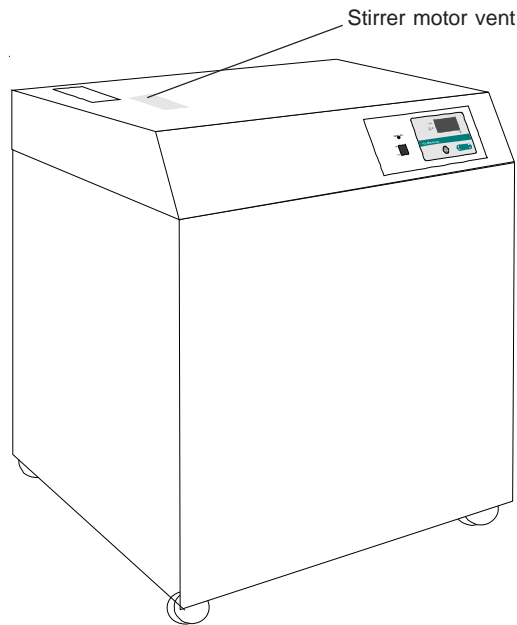

Refer to the table below to determine the approximate amount of air intake required for the unit to retain its full rated capacity. If the air intake does not meet these standards, cooling capacity will be reduced.

	HX 75	HX 150	HX 300
Air Intake			
<i>Cubic feet per minute</i>	600	1050	1900
<i>Liters per minute</i>	17000	29730	53800
	HX 500		HX 750
Air Intake			
<i>Cubic feet per minute</i>	5000		5600
<i>Liters per minute</i>	141750		158800

Site (Water-cooled units)

The unit should be located in a laboratory or clean industrial environment with easy access to a facility cooling water supply and a drain.

All units are equipped with castors for easy movement. This allows the unit to be placed in a small area, as long as there is ample space for the unit to be moved for access on all four sides. A minimum access clearance of 3 feet (1 meter) on two adjacent sides is recommended.

The facility cooling water supply must meet or exceed the requirements listed in the table shown on the next page for the unit to operate at its full rated capacity. If the facility cooling water does not meet these standards, the cooling capacity will be reduced.

As the temperature of the cooling water supply increases, the required flowrate and pressure of the cooling water supply increases.

For example, with a model HX 150, if the temperature of the cooling water supply is +65°F, the flow rate must be at least 1.5 gallons per minute, with a pressure differential of at least 3.5 PSI. However, if the temperature of the cooling water supply is +85°F, the flow rate must be at least 4.0 gallons per minute, with a pressure differential of at least 10 PSI.

If the unit is being used with a building water supply, the back pressure of the drain must be less than the supply pressure.



To prevent damage to the unit's inlet and outlet valves, maximum static facility water pressure should not exceed 150 psig and available supply-to-return differential pressure must not exceed 35 psid across the rated flow range. See next page.

A water-regulating valve, located in the FACILITY WATER INLET line regulates the flow rate of the cooling water supply as it enters the unit. The valve regulates the flow rate based on the heat load. Flow through the unit stops automatically when the unit is shut off.

On models HX 150 through HX 750 a stirrer motor is located under the case top. (Models HX 500 and HX 750 have two stirrer motors.) Heat generated by the stirrer motor is discharged through vents in the case top. Do not block the vents. A minimum clearance of 2 inches (5 centimeters) is necessary for adequate ventilation. See illustration on previous page.

NOTE: HX 75s and units with plate heat exchangers do not have stirrer motors.

Temperature of cooling water supply				
	+55°F (+13°C)	+65°F (+18°C)	+75°F (+24°C)	+85°F (+29°C)
HX 75				
Minimum Flow Rate				
<i>Gallons per minute</i>	0.75*	1.0	1.5	3.0
<i>Liters per minute</i>	2.8*	3.7	5.7	11.4
Minimum Pressure D				
<i>Minimum PSID</i>	1.5*	2.0	3.5	8.0
<i>Minimum Bar</i>	0.10*	0.13	0.24	0.55
HX 150				
Minimum Flow Rate				
<i>Gallons per minute</i>	1.0*	1.5	2.0	3.5
<i>Liters per minute</i>	3.8*	5.7	7.6	13.2
Minimum Pressure D				
<i>Minimum PSID</i>	2.0*	3.5	5.0	10.0
<i>Minimum Bar</i>	0.13*	0.24	0.34	0.69
HX 300				
Minimum Flow Rate				
<i>Gallons per minute</i>	2.5*	4.0	6.5	11.0
<i>Liters per minute</i>	9.5*	15.1	24.6	41.6
Minimum Pressure D				
<i>Minimum PSID</i>	6.0*	8.0	13.5	25.0
<i>Minimum Bar</i>	0.41*	0.55	0.93	1.72
HX 500				
Minimum Flow Rate				
<i>Gallons per minute</i>	3.5	5.0	8.0	16.0
<i>Liters per minute</i>	13.2	18.9	30.3	60.6
Minimum Pressure D				
<i>Minimum PSID</i>	13.0	17.0	23.0	57.0**
<i>Minimum Bar</i>	0.89	1.17	1.58	3.93
HX 750				
Minimum Flow Rate				
<i>Gallons per minute</i>	6.0	8.0	12.5	16.6
<i>Liters per minute</i>	22.7	30.3	47.3	62.8
Minimum Pressure D				
<i>Minimum PSID</i>	14.0	20.0	28.5	40.0**
<i>Minimum Bar</i>	0.96	1.38	1.96	2.76

At 20°C ambient.

*Operating at these pressures may lead to valve "chatter" under some operating conditions.

Facility Water Maximum Inlet Pressure must not exceed 150 PSIG.

Facility Water Maximum Pressure Differential must not exceed 35 PSID under any condition.

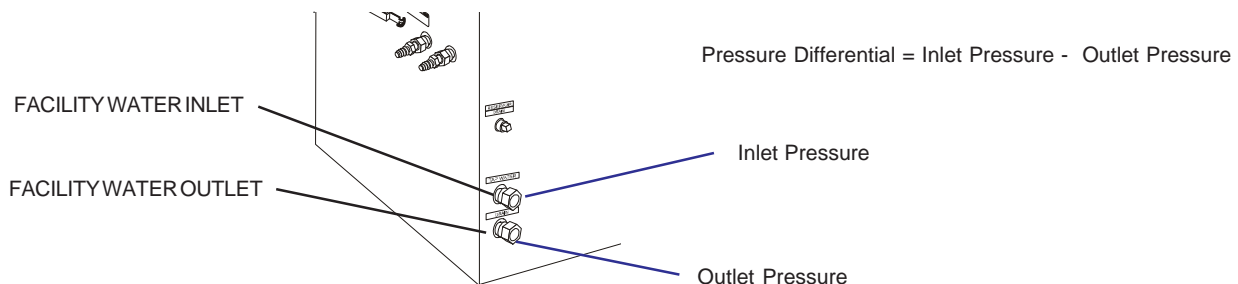

Electrical Requirements



The unit construction provides protection against the risk of electric shock by grounding appropriate metal parts. The protection may not function unless the power cord is connected to a properly grounded outlet. It is your responsibility to assure a proper ground connection is provided.

The user is responsible to ensure that the power cord provided meets local electrical codes. If not, contact qualified installation personnel.

The unit is intended for use on a dedicated outlet. The HX has an internal circuit protection that is equivalent (approx.) to the branch circuit rating. This is to protect the HX, and is not intended as a substitute for branch circuit protection.

Refer to the table below to determine the unit's electrical requirements. Verify the requirements by reviewing the ratings listed on the name plate label on the rear of the case top.

	HX 75 & HX 150		HX 300		
Volts	208-230 220-240		208-230	200-220	380-420
Hertz	60	50	60	50	50
Phase	1	1	3	3	3
Plug	NEMA L6-30P or L6-20P		NEMA L15-30P or L16-20P		
	HX 500 & HX 750				
Volts	208-230		380-420		
Hertz	60		50		
Phase	3		3		

Make sure the voltage of the power source agrees with the unit's voltage and frequency rating. The unit is designed to tolerate deviations of $\pm 10\%$ from the rated line voltage.

Models HX 75 through HX 300 rated 24 Amps or less have an 8 foot (2.4 meter) power cord installed on the unit at the time of shipment.

HX 500s and HX 750s do not have a power cable. Installation of the cable is your responsibility. Wire the unit in conformance to local, state and federal electrical codes. Double check all wiring to make sure it is properly connected and protected from the elements. See the instructions and illustration on the next page.

Models HX 300 through HX 750 are equipped with a compressor crankcase heater. The crankcase heater warms the oil in the compressor and prevents refrigerant from mixing with the oil. Before start up, connect the unit to its power source for at least 12 hours. This allows time for the oil to heat and separate from the refrigerant.

To access the connections open the pullbox.

- Insert your cable through the conduit.
- Locate 3TB and 4TB and connect your cable.
- Close the pullbox.

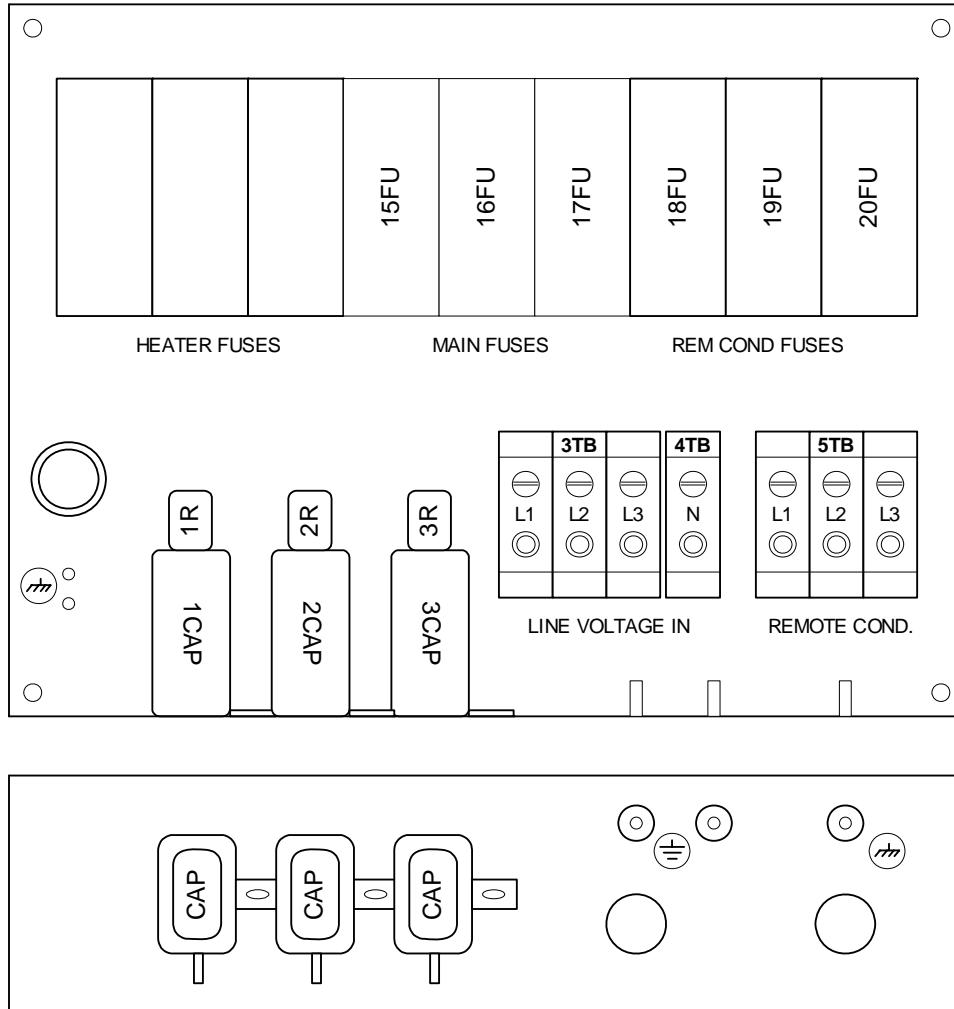

Note: Pullbox shown with remote condenser option.

Plumbing Requirements

Air-cooled and water-cooled units

Before installing the unit to an instrument that previously used facility water as a cooling fluid, flush the instrument several times to remove any rust or scale that has built up. Consult the manufacturer of the instrument for a cleaning fluid recommendation.

The plumbing fittings used to connect the HX to your application are located on the right side of the unit (labelled SUPPLY and RETURN). These connections are $\frac{3}{4}$ inch NPT, 1 inch NPT for units with CP-75 or TU-9 pumps.

Remove the protective plugs from the SUPPLY and RETURN connections. Connect the SUPPLY fitting to the inlet of your application. Connect the RETURN fitting to the outlet of your application.

The RESERVOIR DRAIN connection, located on the rear of the unit, is a $\frac{1}{2}$ inch FPT fitting connected internally to the unit's fluid reservoir. This fitting is for draining the reservoir. The unit is shipped with a $\frac{1}{2}$ inch MPT plug installed in this fitting. Remove the plug to drain the reservoir.

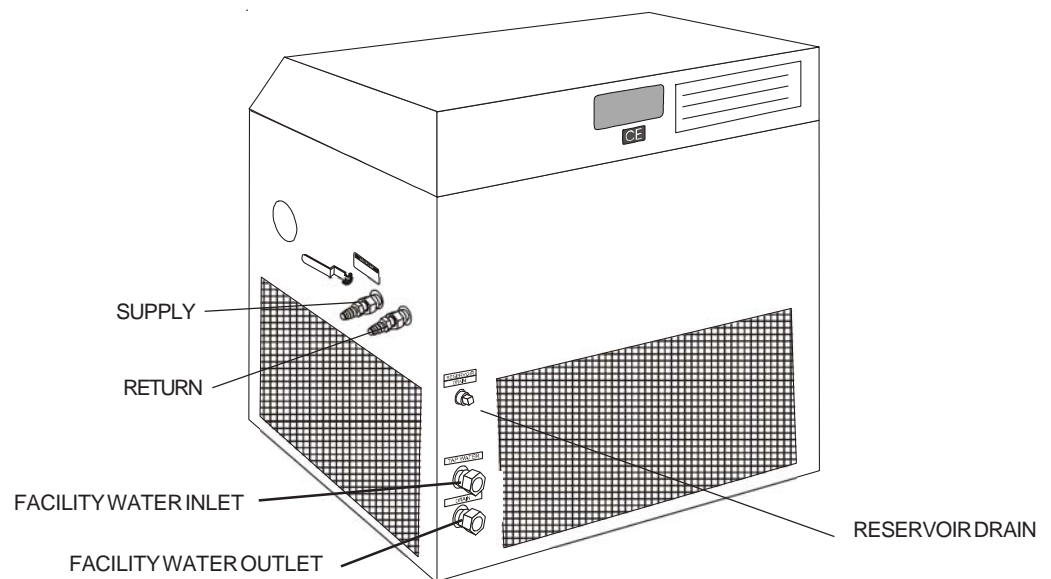

Two plumbing adapters ($\frac{3}{4}$ inch MPT x $\frac{5}{8}$ inch hose) are included with the unit. If the unit is being plumbed to the instrument being cooled using flexible tubing, install the adapters in the SUPPLY and RETURN plumbing ports. To prevent leaking, wrap the threads of the adapters with Teflon® sealing tape before installing them in the plumbing ports. The adapters will accept $\frac{1}{2}$ or $\frac{5}{8}$ inch ID flexible tubing.

Flexible tubing, if used, should be heavy wall or reinforced construction. All tubing should be rated to withstand 110 psi at the unit's highest possible operating temperature. Make sure all tubing connections are securely

clamped. Avoid running tubing near radiators, hot water pipes, etc. If substantial lengths of tubing are necessary, insulation may be required to prevent loss of cooling capacity.

Tubing and insulation are available from Thermo Fisher. Contact our Sales Department for more information (see Preface, After-sale Support).

If the unit is "hard plumbed" to the instrument being cooled or to the cooling water supply, damage can occur if the unit is bumped or jolted from its site. Provisions should be made to prevent the unit from being moved after installation. Once the unit is plumbed, secure the locking castors on the unit's base. If the unit is located in a heavy traffic area where the possibility of collision is possible, we recommend securing the unit to the site using blocks or mounting brackets.

It is important to keep the distance between the unit and your application as short as possible, and to use the largest diameter tubing practical. Tubing should be straight and without bends. If diameter reductions must be made, they should be made at the inlet and outlet of your application, not at the HX.

If substantial lengths of connecting tubing are required, they should be pre-filled with cooling fluid before connecting them to the unit.

Water-cooled units

The plumbing connections used to connect the water-cooled condenser in the HX to the facility cooling water supply are located at the rear of the unit (labelled FACILITY WATER INLET and OUTLET). On HX 75s through HX 300s, these fittings are ½" FPT. On HX 500s and HX 750s, these fittings are 1" FPT.

Remove the plastic protective plugs from the connections. Connect the FACILITY WATER INLET fitting to the facility cooling water supply. Connect the FACILITY WATER OUTLET fitting to a drain.

Automatic Refill Device

The automatic refill device is designed to maintain the correct level of cooling fluid in the reservoir. The device consists of a solenoid valve and a reservoir float switch. If the cooling fluid level falls, the float switch drops, opening the solenoid valve and allows makeup fluid to fill the reservoir. The controller will display Add. Once the cooling fluid level reaches the proper level, the float switch rises and the solenoid valve closes. The controller will display the reservoir fluid temperature.

The plumbing connection for the refill device is located at the left rear corner of the unit and is labelled AUTO REFILL. This connection is a ⅜ inch OD stainless steel barbed fitting. Connect this fitting to a makeup fluid source using ⅝ or ¾ inch ID flexible tubing. Make sure all tubing connections are securely clamped.

Tubing is available from Thermo Fisher. Contact our Sales Department for more information (see Preface, After-sale Support).

Fluids



Never use flammable or corrosive fluids with this unit. Do not use automotive antifreeze. Commercial antifreeze contains silicates that can damage the pump seals. Use of automotive antifreeze will void the manufacturer's warranty.

Thermo Fisher recommends using distilled/deionized water with a 0.05 to 0.1 MOhmcm reading.



Highly distilled/deionized water, above the 3 MOhmcm region, may become aggressive and is not recommended for use with units with wetted parts other than stainless steel. Distilled/deionized water in the 15 MOhmcm region is definitely aggressive and should not be used. Units operating in these regions should be closely monitored. See Water Quality Standards and Recommendations in this section.

If you do not have access to distilled/deionized water we recommend using filtered facility water. Thermo Fisher cannot recommend any custom fluids, these fluids are too dependent on your particular application.



If your unit is equipped with a plate heat exchanger do not use 100% water as a recirculating fluid. Due to the physical nature of a plate heat exchanger, and its response to temperature changes, using 100% water may cause the plate heat exchanger to rupture.

Below +8°C, a non-freezing solution is required. A 50/50 mixture, by volume, of distilled/deionized water and laboratory grade ethylene glycol is suggested. The selected cooling fluid must have a viscosity of 50 centistokes or less.



Ethylene glycol (EG) is hygroscopic, it will absorb water from its environment. This can affect the freezing point and boiling point of the fluid over time. This may result in system failure.



When using EG/water top-off with EG/water. Do not top-off with plain water. Topping-off with plain water can severely affect the freezing point and boiling point of the fluid. This may result in system failure.



Do not use a Deionization (DI) filter with Inhibited EG. A DI filter will remove inhibitors from the solution rendering the fluid ineffective against corrosion protection. Also, inhibitors increase fluid conductivity.

For units with extended temperature ranges above +35°C, we recommend distilled/deionized water up to +80°C. Above +80°C, you are responsible for the fluid(s) used.

Water Quality Standards and Recommendations

	Permissible (PPM)	Desirable (PPM)
Microbiologicals		
(algae, bacteria, fungi)	0	0
Inorganic Chemicals		
Calcium	<40	<0.6
Chloride	<250	<25
Copper	<1.3	<1.0
Iron	<0.3	<0.1
Lead	<0.015	0
Magnesium	<12	<0.1
Manganese	<0.05	<0.03
Nitrates\Nitrites	<10 as N	0
Potassium	<20	< 0.3
Silicate	<25	<1.0
Sodium	<20	< 0.3
Sulfate	<250	<50
Hardness	<17	<0.05
Total Dissolved Solids	<50	<10
Other Parameters		
pH	6.5-8.5	7-8
Resistivity	0.01*	0.05-0.1*
* MOhmcm (compensated to 25°C)		

Unfavorably high total ionized solids (TIS) can accelerate the rate of galvanic corrosion. These contaminants can function as electrolytes which increase the potential for galvanic cell corrosion and lead to localized corrosion such as pitting which can be observed at the studs and on the outside surface of cooling coils. Eventually, the pitting will become so extensive that the coil will leak refrigerant into the water reservoir.

As an example, raw water in the United States averages 171 ppm (of NaCl). The recommended level for use in a water system is between 0.5 to 5.0 ppm (of NaCl).

Recommendation: Initially fill the tank with distilled/deionized water. Do not use untreated facility water, as the total ionized solids level may be too high.

Maintain this water quality at a resistivity of between 1 to 10 MOhmcm (compensated to 25°C) by using a purification system. Although the initial fill may be as high as 10 MOhmcm (compensated to 25°C), the desired level for long time usage is 1 to 3 MOhmcm (compensated to 25°C).

These two recommendations will reduce the electrolytic potential of the water and prevent or reduce the galvanic corrosion observed.

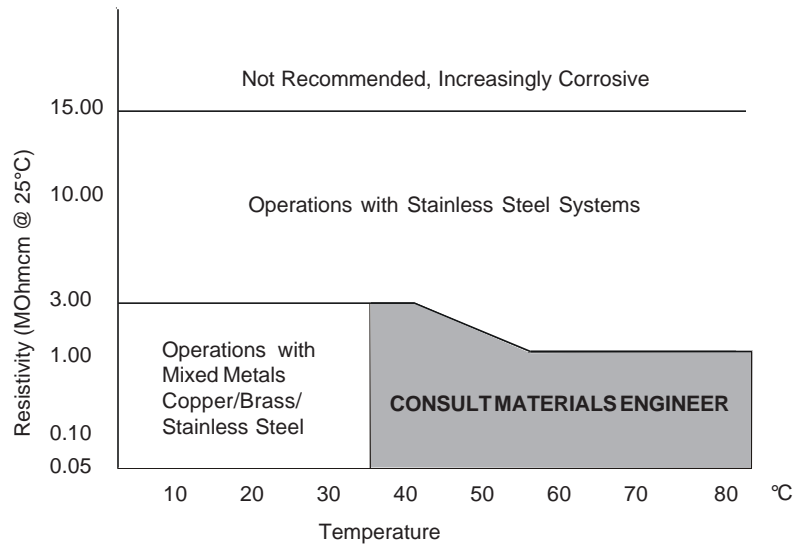

Filling Requirements

The reservoir access panel is located at the left rear corner of the case top. To open the access panel, slide the latch back (towards the rear of the unit) and lift.

The reservoir cover is located below the access panel. Loosen the thumbscrews and remove the reservoir cover. Fill the fluid reservoir with cooling fluid to within 1 inch of the top.

The fluid capacity of the instrument being cooled and the recirculation lines may be significant. To prevent the lowering of the fluid level in the reservoir below the operating level, have extra cooling fluid on hand to keep the reservoir filled to within 1 inch of the top.

When the recirculating system is full, replace the reservoir cover and the access panel.

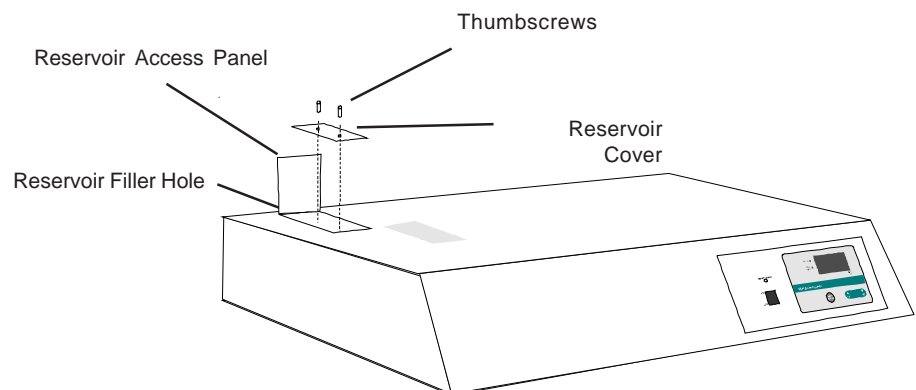

Blank page.

Section IV Operation

Start Up/Shut Down

Before starting, check all electrical and plumbing connections and make sure the recirculating system (the HX, your application, and the recirculation lines) has been properly filled with cooling fluid. Also, make sure the flow control valve is properly set (see Flow Control in this section). For CE Mark units ensure the circuit breaker on the right hand side of the unit is on.

For water-cooled units — ensure that the facility water is turned on.

HX 300s through HX 750s are equipped with a compressor crankcase heater. The crankcase heater warms the oil in the compressor and prevents refrigerant from mixing with the oil. Before start up, the unit must be connected to its power source for at least 12 hours. This allows time for the oil to be heated and separate from the refrigerant.

To start the unit, place the ON/OFF switch in the ON position. The pump and refrigeration system will start. The °C display will indicate the reservoir fluid temperature. After starting recheck the fluid level, a "top off" may be needed.

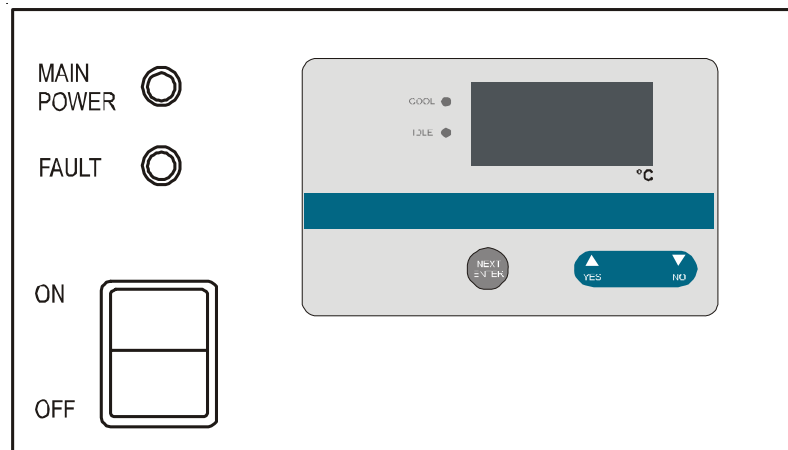

The COOL and IDLE LEDs indicate the status of the refrigeration system. COOL illuminates to indicate the refrigeration system is removing heat from the cooling fluid. As the operating temperature approaches the temperature setpoint, the COOL LED will extinguish.

IDLE illuminates to indicate the refrigeration system is not removing heat from the cooling fluid because the temperature has dropped below the setpoint. When the reservoir temperature approaches the setpoint the LED will flash. When the temperature reaches the setpoint the LED will extinguish.

To shut the unit off, place the ON/OFF switch in the OFF position.

When the unit is shut off, wait approximately five minutes before restarting. This allows time for the refrigeration pressures to equalize. If the pressures are not allowed to equalize, the compressor will short-cycle (clicking sound) and no cooling will occur.

Digital Controller

The digital controller controls temperature using a PID (Proportional-Integral-Derivative) algorithm. It is designed with self-diagnostic features and easy to use operator interface.

NEXT ENTER 

Use this key to accept and save changes.

YES, ▲

This key is used to increase numerical values.

NO, ▼

This key is used to decrease numerical values.

Setpoint

When the controller is powered it displays the reservoir fluid temperature. Press the **NEXT ENTER** key to view the setpoint. The display flashes between **SP** and the actual setpoint number. If desired, use the **YES** and **NO** keys to change the setpoint. The display flashes as soon as either key is depressed. Once the desired setpoint is displayed, press **NEXT ENTER**.

NOTE: The new value will not be used by the controller until **NEXT ENTER** is depressed and the display stops flashing. The controller will not allow you to enter a value above the maximum or below the minimum value, or any illegal value. If you try to enter an illegal value the display will revert to its original value when the last digit was entered.

If **NEXT ENTER** is not depressed within one minute, the controller will time out and the new value will not be accepted. The controller will revert to the previous value.

NOTE: Error codes are addressed in Section VIII, Service.

Setup Loop

The controller is used to view the unit's configuration, and to set temperature limits and PID parameters. Thermo Fisher recommends that only a qualified technician change the PID values. Values can be changed using the YES and NO keys. Press the NEXT key twice to accept the new value.

Select IndC to configure the unit to keep running in the event of a fault, select FLt to configure the unit to shut down.

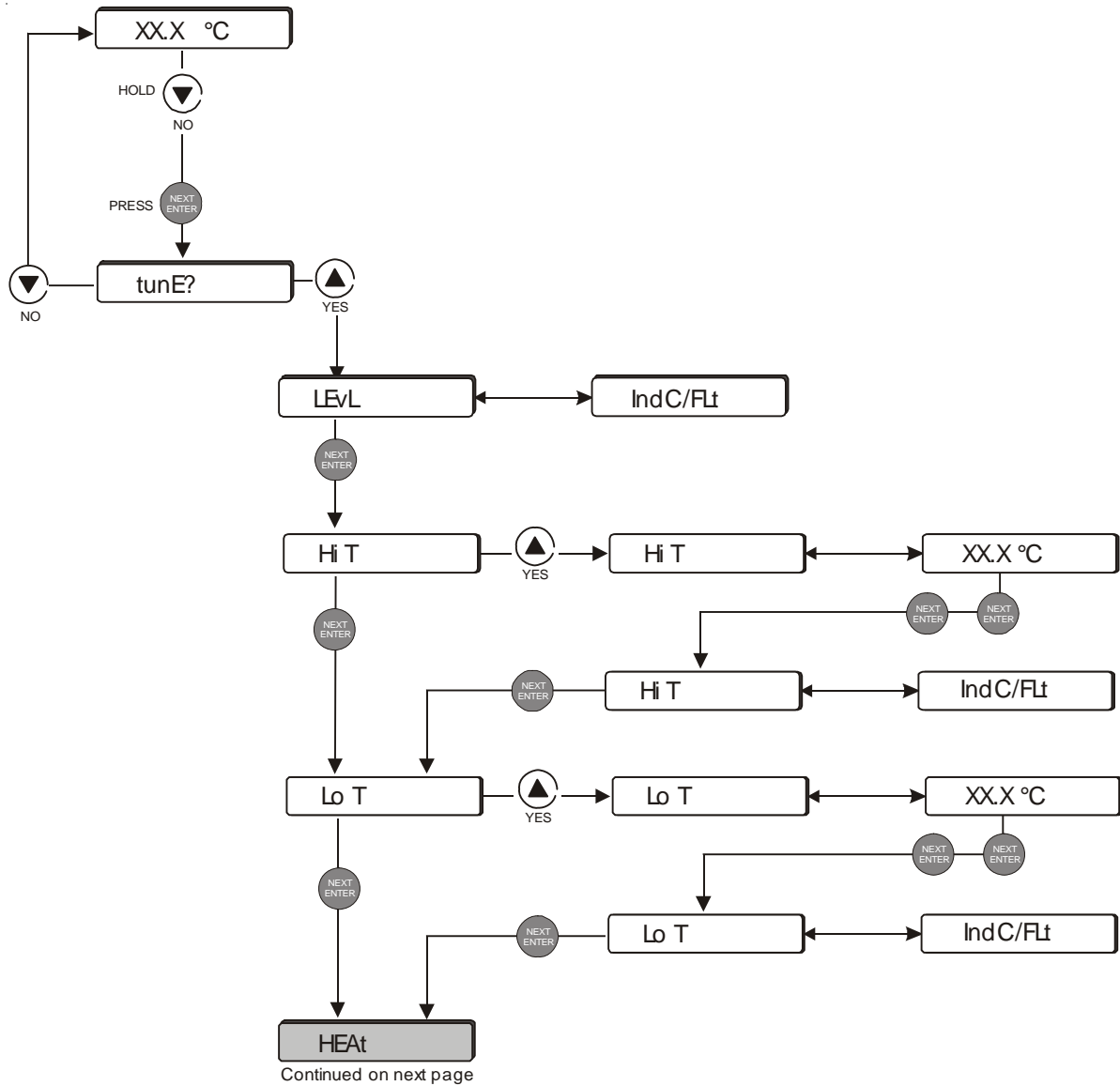

Setup Loop (1 of 2)

Continued from previous page

We recommend only a qualified technician change the PID values. Incorrect PID values will hamper unit performance.

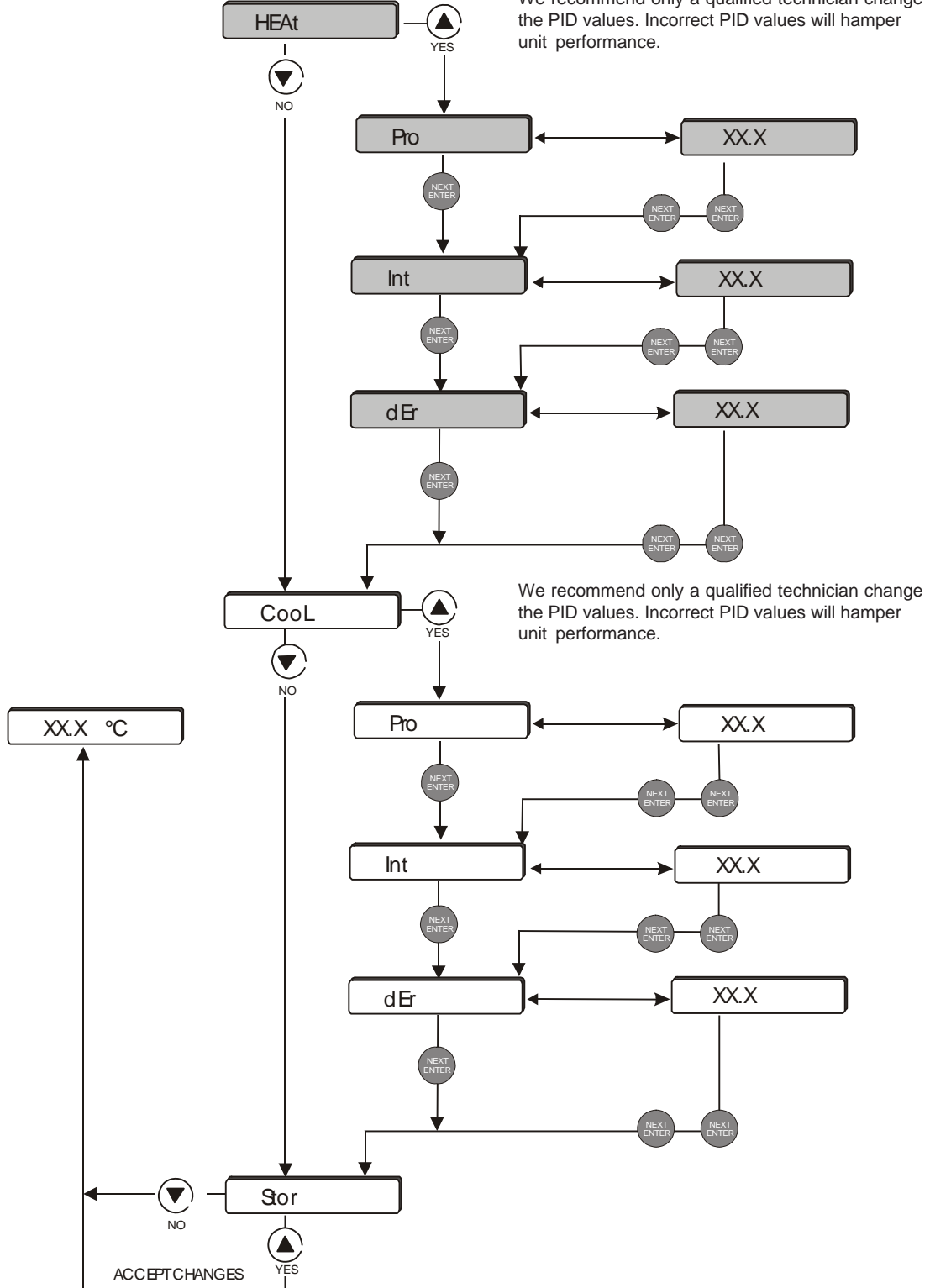

We recommend only a qualified technician change the PID values. Incorrect PID values will hamper unit performance.

Setup Loop (2 of 2)

NOTE: Should you desire to return to the temperature display and abort *all* changes, keep pressing NEXT until the display reads **Stor**. Press **NO**.

15-Pin Interface

A female 15-pin interface connector is located on the rear of the unit. The connector is also a status relay contact and a remote on/off control. The interface allows you to set the high and low temperature limits, and low fluid level, as faults.

A status relay energizes when the unit is powered. When an error occurs this relay de-energizes. If the unit is IndC configured, press any controller key to clear the error message. If the unit is FLt configured, cycle the MAIN POWER ON OFF switch to clear the error message. See Setup Loop on page 29.

To use the remote start, place the ON/OFF LOCAL REMOTE switch to the REMOTE position, place the MAIN POWER ON OFF switch to ON, and then apply a 24VAC $\pm 10\%$ signal to the interface. The unit will stop when the MAIN POWER switch is turned OFF or when the signal is removed.

The pin out information is:

Pin 1	Chassis ground
Pin 9	Status relay contact open on error
Pin 10	Status relay contact closed on error
Pin 11	Status relay common
Pin 13	On/off relay coil
Pin 14	On/off relay coil

The status relay is rated 2 amps at 24 V AC/DC and ≤ 0.8 Ohms contact resistance. The on/off relay coil is rated 24VAC $\pm 10\%$.

Flow Control

The RECIRCULATING FLOW CONTROL handle, located on the right-hand side of your unit, is connected to a valve that controls the flow rate of the cooling fluid to the instrument being cooled.

When the handle is in the full vertical "+" position, the valve is open and all possible cooling fluid is supplied to the instrument being cooled. When the handle is in the full horizontal "-" position, the valve is closed and no cooling fluid is supplied to the instrument being cooled. When the handle is between these two positions, the flow rate of the cooling fluid is between full flow and no flow. Use a flow meter on the SUPPLY line to adjust the desired flow rate.

The handle is normally closed for start up. Once the unit is running slowly open the valve for the desired flow rate. If the unit is equipped with an optional flow sensor, the flow control valve must be opened slightly on start up to allow fluid to circulate through the flow rate sensor. For small pumps, a flow rate of more than 0.3 gpm (1.0 lpm) is necessary. For large pumps, a 1.0 gpm (3.8 lpm) is needed.



Never rapidly move the valve wide open from the closed or slightly open position.

Pressure Gauge

The RECIRCULATING PRESSURE gauge is located next to the flow control handle. The gauge indicates the operating pressure of the system.

Section VI Optional Features

External Pressure Regulator

For applications requiring a maximum pressure less than 55 psi, an External Pressure Reducer (EPR) is available. An EPR allows an adjustable operating pressure of 10 to 50 psi. If the pressure of the fluid leaving the unit exceeds the valve setting the relief valve will bypass the fluid back into the unit to relieve the pressure. The back pressure of the connected equipment and the flow rate of the recirculating fluid to your application determine the pressure of the system.

Connect the EPR assembly as shown below. Tighten the hose clamps tight enough to prevent leakage. Do not overtighten or the clamps will “bite” into the flexible tubing and can cause excessive wear.

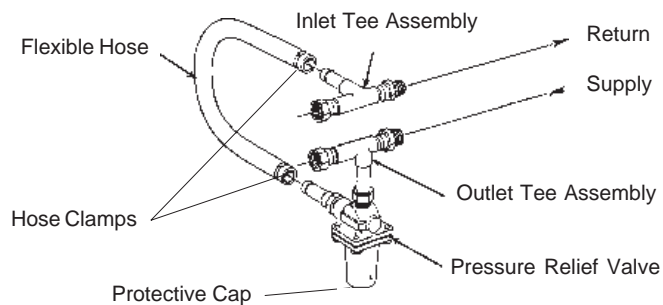

Connect the outlet tee assembly to the inlet of your application. Connect the inlet tee assembly to the outlet of your application.

Adjustment

When adjusting the relief valve some leaking may occur, place a container under the valve during adjustment.

Remove the protective cap and locate a threaded fitting with a slot for a large screwdriver. Hold the threaded fitting in place and loosen the lock nut on the valve body until it is almost flush with the threaded fitting. Unscrew the threaded fitting three to four turns. (If the threaded fitting unscrews completely from the valve housing, screw it back in two to three turns.)

To simulate blockage, close (or pinch off) the hose between the EPR outlet tee assembly and your application. Monitor the operating pressure of the HX unit. Turn the threaded fitting until the desired relief pressure is set (the EPR valve cannot be set lower than the total back pressure of your instrument, or flow will not be received).

Tighten the locknut to secure the position of the threaded fitting. Open the hose between the EPR outlet tee assembly and your application.

Particulate Filters

Particulate filter assemblies attach to the supply side of the recirculation water. Refer to the separate manual attached to the filter assembly.

The frequency for cleaning/changing the filter depends on your usage. Should the unit's performance be degraded, check the filter.

Filters are available from Thermo Fisher, contact our Customer Service Center. Before calling refer to the name plate label on the rear or side of the unit to obtain the following information:

-BOM number

-Serial number

Section VII Maintenance

Service Contracts

Thermo Fisher Scientific offers on-site Service Contracts designed to provide extended life and minimal downtime for your unit. For more information, contact our Service Department (see Preface, After-sale Support).

Condenser Cleaning (Air-cooled units only)

For proper operation, the unit needs to pull substantial amounts of air through a finned condenser. A build up of dust or debris on the fins of the condenser will lead to a loss of cooling capacity.



Eventually the compressor will overheat and the High-Pressure Cutout (HPC) will activate and temporarily shut down the unit. The HPC will cycle the unit on and off until the condenser is cleaned. After a period of time, this cycling will damage the unit's compressor.

The frequency of cleaning depends on the operating environment. We recommend making a monthly visual inspection of the condenser after initial installation. After several months, the cleaning frequency will be established.

For "standard" air-cooled units, periodic vacuuming of the fins on the condenser is necessary. For units with the optional remote air-cooled condenser, remove any debris from around the condenser site. If a visible accumulation of dust or dirt is found on the condenser fins, the condenser should be cleaned with a condenser cleaning solvent and rinsed with water.



Exercise caution not to damage the condenser fins or coil. Condenser fin or coil damage can result in a loss of performance and, in extreme cases, refrigeration system failure.

Hoses

The unit's internal and external hoses and clamps should be inspected and tightened on at least a semiannual basis.

Algae

To restrict the growth of algae in the fluid reservoir, we recommend the reservoir cover be kept in place and that all recirculation lines be opaque. This will eliminate the entrance of light, which is required for the growth of most common algae.

We recommend the use of Chloramine-T, 1 gram per 3.5 liters. Other algicides can be harmful to the unit's internal components. Contact us for additional information.

Blank page.

Section VIII Service



For personal safety and equipment reliability, only a qualified technician should perform the following procedure. Contact our Service Department for assistance (see Preface, After-sale Support).

Configuration

Case Top

The unit has a hinged case top to allow service access. The case top is secured to the top of the unit base by a hinge between the case top and base (along the rear of the unit), and by two spring clips located at the front corners, see illustration on page 9. To gain access to the pump assembly or the reservoir area, disengage the spring clips with a flat bladed screw driver and lift the front of the top cover and tilt it back. A support brace, located on the right side of the inner base, will stop and support the case top. Ensure the spring clips engage when the top is lowered back into position.

Reservoir Cover

Access to the inside of the fluid reservoir is necessary to clean the reservoir. The figure below illustrates a typical layout of the components mounted on top of the reservoir cover. The component layout varies depending on the unit size. If you are unable to identify the components on your unit's reservoir cover, contact our Customer Service Department for assistance (see Preface, After-sale Support).

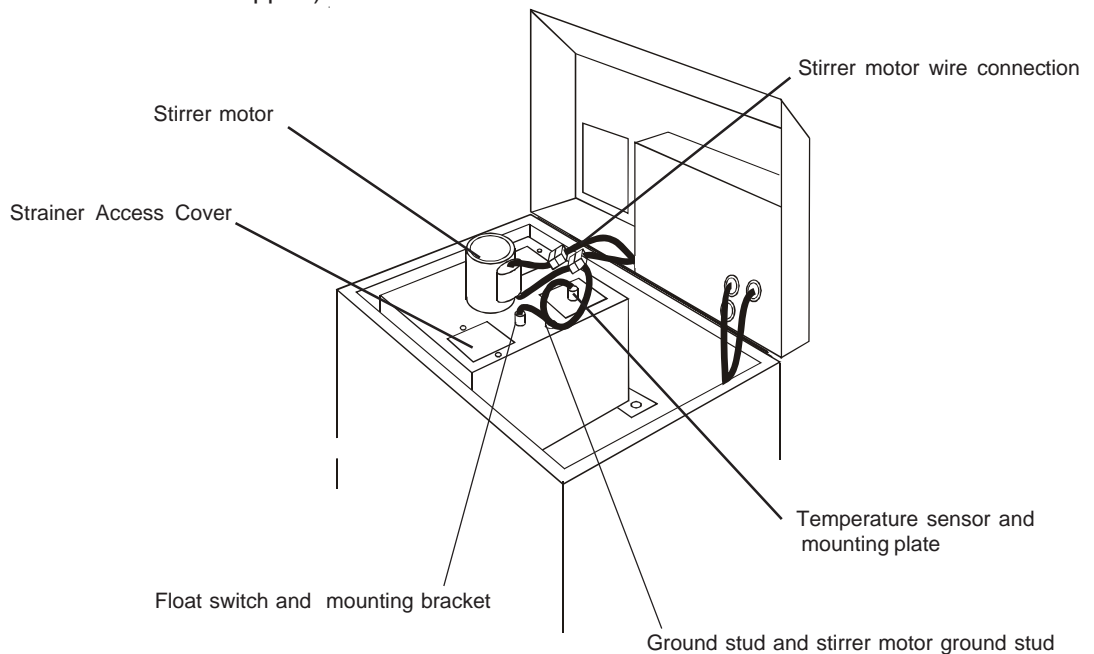

Disconnect the unit from its power source before removing the reservoir cover.

Locate the reservoir stirrer motor (units with plate heat exchangers and HX 75s do not have a stirrer motor; HX 500s and HX 750s have two stirrer motors). Disconnect the motor wires at the plug located on the side of the electrical box cover. Also disconnect the green ground wire that connects the ground stud on the reservoir cover to the unit's grounding bar.

Locate the float switch mounting bracket. Remove the two stainless steel screws that secure the bracket to the reservoir cover. Carefully remove the mounting bracket and place the assembly in an area adjacent to the reservoir. Make sure not to strain the connecting wires.

Locate the temperature sensor mounting plate. Remove the two stainless steel screws that secure the bracket to the reservoir. Carefully remove the sensor mounting plate with the sensor(s) attached and place the assembly in a protected area adjacent to the reservoir. Make sure not to damage the sensor(s) or strain the connecting wires.

Remove the stainless steel screws that secure the reservoir cover to the reservoir. Remove the cover and place it to one side in a manner that protects the stirrer motor blades from being bent.

Service Access Panels

Service access panels on your unit allow easy access to the pump and refrigeration assemblies. Panel location varies with the size and type of unit. The panels are designed to allow removal without disconnecting the HX from the instrument being cooled.



Disconnect the unit from its power source before removing any of the access panels.

Reservoir Cleaning

Periodic reservoir cleaning is necessary. We recommend making a monthly visual inspection of the reservoir after initial installation. After several months, the frequency of cleaning will be established.



Disconnect the unit from its power source and drain the reservoir before cleaning the reservoir.

Lift the top cover to access the reservoir. Remove the reservoir cover as described in Configuration. Clean the reservoir with a cleaning fluid compatible with the recirculating system and the cooling fluid.



Do not use steel wool or other abrasive materials. They can scratch the stainless steel surface and initiate rusting.

When the reservoir is clean, reassemble the cover assembly and close the case top. Refer to Section III, Filling Requirements for instructions on replacing the cooling fluid.

Pump Strainer

Units with PD and TU pumps have pump strainers that require cleaning. If debris is drawn into the recirculating system, the pump strainer will prevent the material from being drawn into the pump and damaging the pump vanes.

After initial installation, the strainer may become clogged with debris and scale. Clean the strainer after the first week of installation. After this first cleaning, a monthly visual inspection is recommended. After several months, the frequency of cleaning will be established.



Disconnect the power cord from the power source and drain the fluid reservoir before cleaning the strainer. Do not operate the unit with any strainer removed.

The wire mesh pump strainer is located in the reservoir on the pump suction line. Remove the strainer access panel located on top of the reservoir cover to access the strainer, see illustration on page 37.

Cover the strainer with a plastic bag to help catch any debris that may become dislodged during removal.

Unscrew the strainer and rinse it with water. Replace the strainer. Refer to Section III, Filling Requirements for instructions on replacing the cooling fluid.

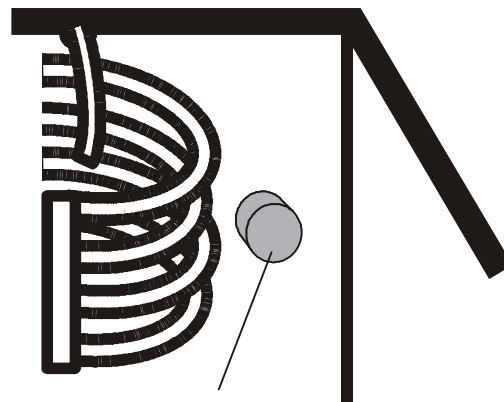

Pump Strainer

Error Codes

The controller also has the capability to display error codes. The codes are:

Display	Indication
Er00	ROM Checksum
Er01	RAM Test Fail
Er02	Keypad Test Failed
Er03	EEPROM Critical Parameters Checksum
Er04	EEPROM Noncritical Parameters Checksum
Er05 -13	Interrupt Error
Er14	Synchronous Error - check connections
Er15	Asynchronous Error
Er16	Bad Calibration Data - Redo Calibration
Er19/Lot	Low Temperature Alarm - Latching Error
Er20/Add	Level Warning - Self Clearing
Er21/Hit	High Temperature Alarm - Latching Error
Er22	High Temperature Limit (Fixed) - Latching Error
Er23	Shorted RTD2 (Optional/If Enabled) - Latching Error
Er24	Open RTD2 (Optional/If Enabled) - Latching Error
Er25	Shorted RTD1 - Latching Error
Er26	Open RTD1 - Latching Error
Er27/LoFL	Low Flow (Optional) - Latching Error
Er31/LLF	Low Level Fault
Er33	Low Temperature Limit (Fixed) - Latching Error
Er50	Auxiliary Error (Optional) - Self Clearing
Er51/PrES	Pressure Cutout (Optional) - Self Clearing
Er52	System Error - Self Clearing

Self clearing errors clear after the error condition is corrected. Latching errors clear after the error is corrected and any key on the controller is pressed.

If the unit is IndC configured, press any controller key to clear the error message. If the unit is FLt configured, cycle the MAIN POWER ON OFF switch to clear the error message.

The unit is supplied with two reservoir level switches. The first switch illuminates the Add display and activates the auto refill device. The second level switch is a safety interlock. It illuminates the LLF display.

The unit may be supplied with an optional flow sensor. The error setpoint may be preset or adjustable.

Pump Motor Lubrication

Some units with PD pumps require pump motor lubrication. Refer to the name plate label on the rear of the case top to identify the specific pump in your unit.

Several companies manufacture motors used to drive the pump. These motors use sleeve type bearings with large oil reservoirs. Oiling instructions are generally posted on each motor. In the absence of instructions, add approximately 30 to 35 drops of SAE 20 non-detergent oil in each fill hole on the following schedule (SAE 20 = 142 CS viscosity):

Duty Cycle	Oiling Frequency
Continuous	Once every year
Intermittent	Once every 2 years
Occasional	Once every 5 years

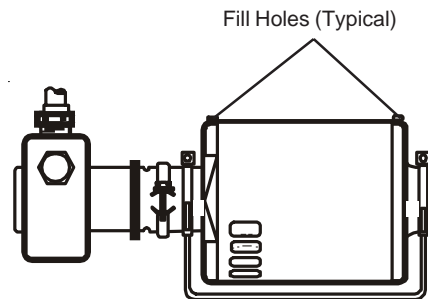

Phase Rotation

Three-phase units with three-phase pump motors are equipped with a phase rotation interlock. Refer to the name plate label on the rear of the case top for the specific electrical requirements of your unit. The interlock, located behind the access panel under the bonnet, prevents the unit from starting if the phase rotation is wrong and causes an Er52 display on the controller. If the unit will not start, see Section IX, Checklist. If the options in the checklist are not applicable, the problem may be phase rotation.

If phase rotation is the problem, disconnect the unit from its power source, remove the pullbox cover. Reverse any two line conductors on the line side of the relay. See page 20.



Never remove the green ground wire.

Replace the pullbox cover. Reconnect the unit to its power source. If the unit will not start, contact our Customer Service Department.

High/Low Pressure Cutouts

All units, except air-cooled HX 75s, have a high pressure cutout. The high pressure switch is a safety device on the discharge side of the compressor. Should the unit's refrigeration discharge pressure become too high the high pressure cutout will activate and shut down the compressor and the controller will display Er52. High pressures can be caused by a lack of cooling water to the compressor or debris in the refrigeration lines.

Some units have a low pressure switch. The low pressure switch is on the suction side and protects the refrigeration system from operating under low refrigeration pressures. Should the unit's refrigeration discharge pressure become too low the low pressure cutout will activate and shut down the compressor and the controller will display Er52. Low pressures can be caused by a leak in the refrigeration lines.

Once the cause of the problem has been identified and corrected you must manually reset the cutout. Units have a yellow sticker identifying the cutout location. The switch(es) can be accessed through the opening in the service panel

There are two types of switches. Either locate the white switch on the cutout and press in on the switch until a "click" is heard. (If the switch does not "click" the cutout was not activated and the unit shut down occurred for another reason.) On the other type move the green switch on top the cutout as shown.

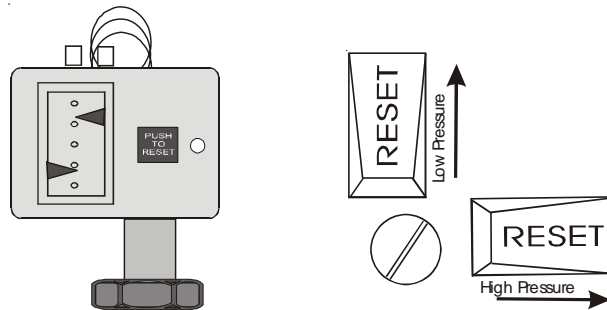

Pump Motor Overload Protector

Refer to the name plate label for the specific electrical requirements of your unit; specifically, identify the phase requirements of your unit.

The pump motor overload protector prevents the pump motor from exposure to excessive current. If an overload fault occurs, due, for example, to excessive pressure or flow, or excessive ambient temperature, the overload protector will shut off the unit and the controller will display Er52 until the overload is reset.

The protector is located behind the access panel under the bonnet.

Pressure Relief Valve (PD and TU Pumps Only)

Units with a PD or TU pump have an adjustable pressure relief valve. Refer to the name plate label on the rear of the case top to identify the specific pump in your unit.

The pressure relief valve establishes the maximum operating pressure of the unit. If the pressure of the fluid leaving the pump exceeds the valve setting, the relief valve will bypass the fluid within the unit to relieve the pressure. The valve does not determine the actual operating pressure; the back pressure of the connected equipment and the setting of the flow control valve determine the operating pressure of the system. If adjustment seems necessary, consult our Service Department for assistance.

Before calling, refer to the name plate label on the rear of the case top to obtain the following:

- *BOM number*
- *Serial number*

Refrigeration Data

Refer to the name plate label on the rear or side of the unit to identify the specific refrigeration data for your unit. For any additional data contact Thermo Fisher.

Blank page.

Section IX Troubleshooting

Displaying Software Version

To display the software version ensure the controller is displaying the reservoir fluid temperature. Depress and hold NO for at least 10 seconds. For example, 0507 displays software version digits to **left** of decimal. Note, the two leading zeros do not display. Press NEXT ENTER. 48 displays software version digits to **right** of decimal. Press NEXT ENTER. 1 displays software version revision letter (as its equivalent number - display cannot show letters. A=1, B=2, etc.) Press NEXT ENTER 0000 displays checksum - this can be disregarded. Press NEXT ENTER to return to reservoir fluid temperature.

Checklist

Unit will not start or cycles on and off

Check house circuit breaker.

HX 300s through HX 750s are equipped with a compressor crankcase heater. The crankcase heater warms the oil in the compressor and prevents refrigerant from mixing with the oil. Before start up, the unit must be connected to its power source for at least 12 hours. This allows time for the oil to be heated and separate from the refrigerant.

For CE Mark units, check the circuit breaker setting on the bonnet.

For units equipped with an optional Emergency Off (EMO) button, ensure it has not been activated. The EMO location varies, but it is usually located next to the controller.

For units equipped with an optional REMOTE LOCAL switch, check its position.

Check for a error message. Depress the NEXT ENTER button.

On air-cooled units, ensure the condenser fins are clean and that proper airflow is not restricted.

On water-cooled units, ensure the facility water is on and make sure the cooling water supply is connected to the FACILITY INLET connection, not the FACILITY OUTLET connection. Check the High Pressure Cutout, it may need to be reset (see Section VIII, High/Low Pressure Cutouts).

Check power source for correct voltage output. Refer to the name plate label on the rear of the unit for the specific electrical requirements of your unit. Power source must be specified voltage, $\pm 10\%$.

On three phase units with three phase pump motors, the phase rotation may be reversed (see Section VIII, Phase Rotation).

Unit will not circulate fluid

Check the tubing, strainer, and any optional filters/cartridges between the unit and your application for obstructions or for cleaning/replacement.

Units with PD and TU type pumps may require pump strainer cleaning. Refer to the name plate label on the rear of the case top to identify the specific pump in your unit. For instructions on cleaning the pump strainer (see Section VIII, Pump Strainer).

On units with PD pumps, check the pump and coupling. Make sure the power is off and locate the brass pump and grey motor. A silver clamp ring holds the two together. Remove the clamp and separate the pump and motor. First look to see if the coupling is broken or not, and then check the pump shaft by rotating. If it is seized or sticks then it has failed. Contact Thermo Fisher.

On units with CP type pumps, if the back pressure of the instrument being cooled is greater than the maximum pressure of the pump, adequate flow may not be obtained. Check for obstructions in the tubing.

Inadequate temperature control

Check/adjust the setpoint.

Make sure the installation of the unit is in compliance with the conditions described in Section III.

Make sure the heat load of the instrument being cooled is not greater than the cooling capacity of the unit.

When the unit is shut off, wait approximately five minutes before restarting. This allows time for the refrigeration pressures to equalize. If the pressures are not allowed to equalize, the compressor will short-cycle (clicking sound) and no cooling will occur.

The controller circuit board may be defective.

Service Assistance

If, after following these troubleshooting steps, your unit fails to operate properly, contact our Service Department for assistance (see Preface). Before calling, please obtain the following information:

BOM number

Serial number

Voltage of unit

Voltage of power source

Temperature of facility water

Software version

Section X Diagrams

**Refrigeration
Flow Diagram
(HX 75 and HX 150)**

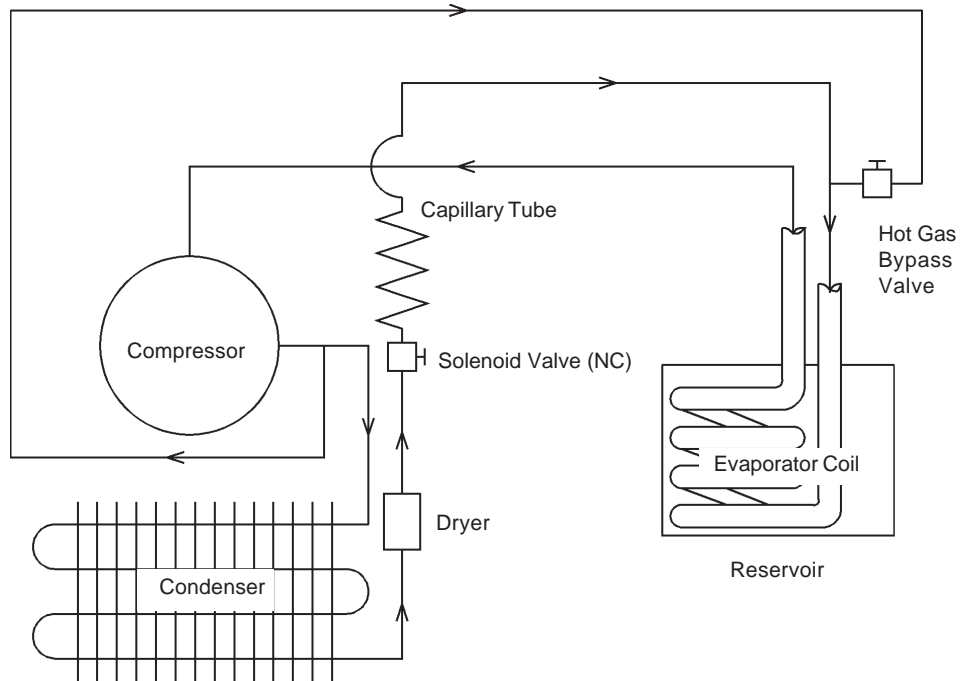

**Refrigeration
Flow Diagram
(HX 300 through HX 750)**

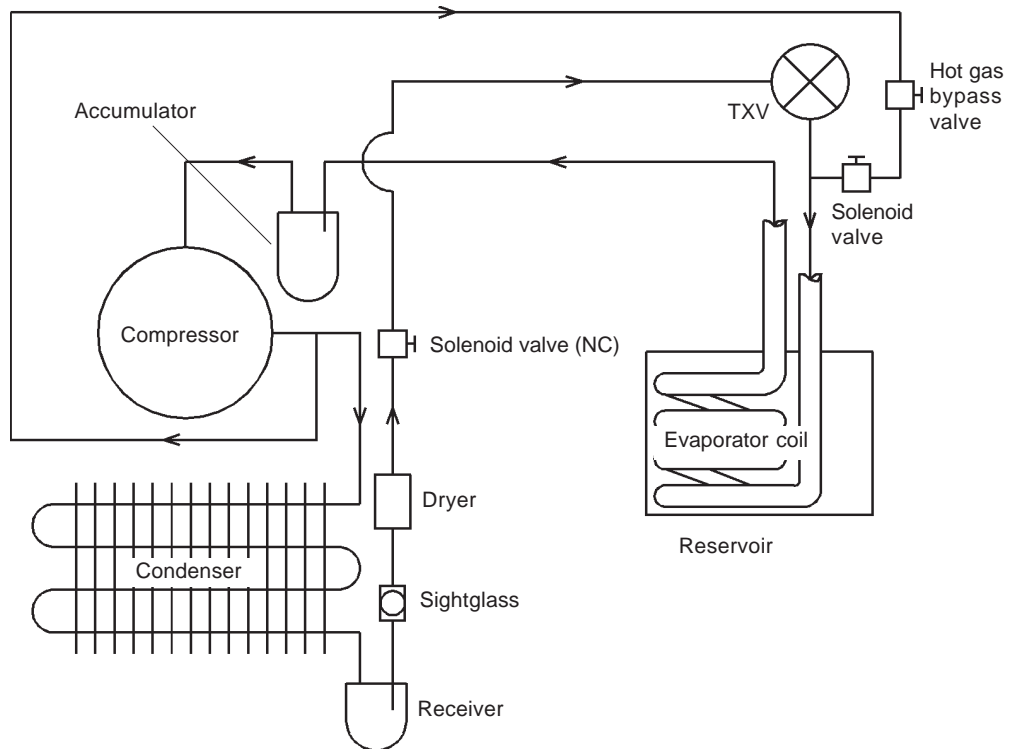

Pump Flow Diagram (CP Pumps)

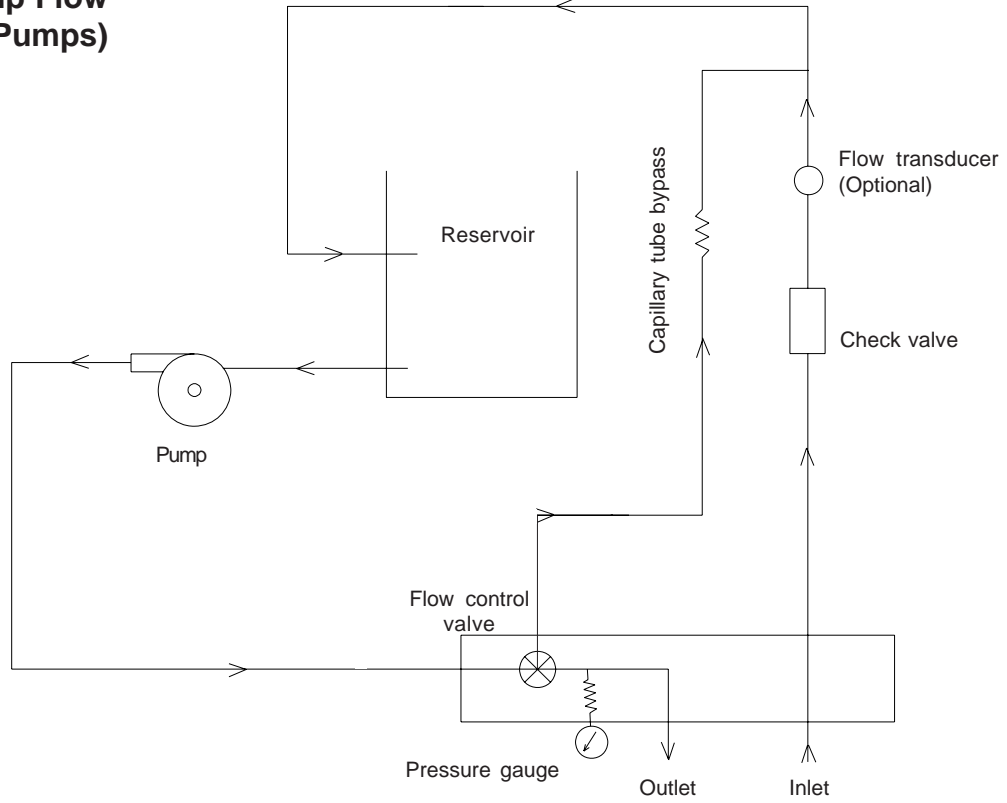

Pump Flow Diagram (PD and TU Pumps)

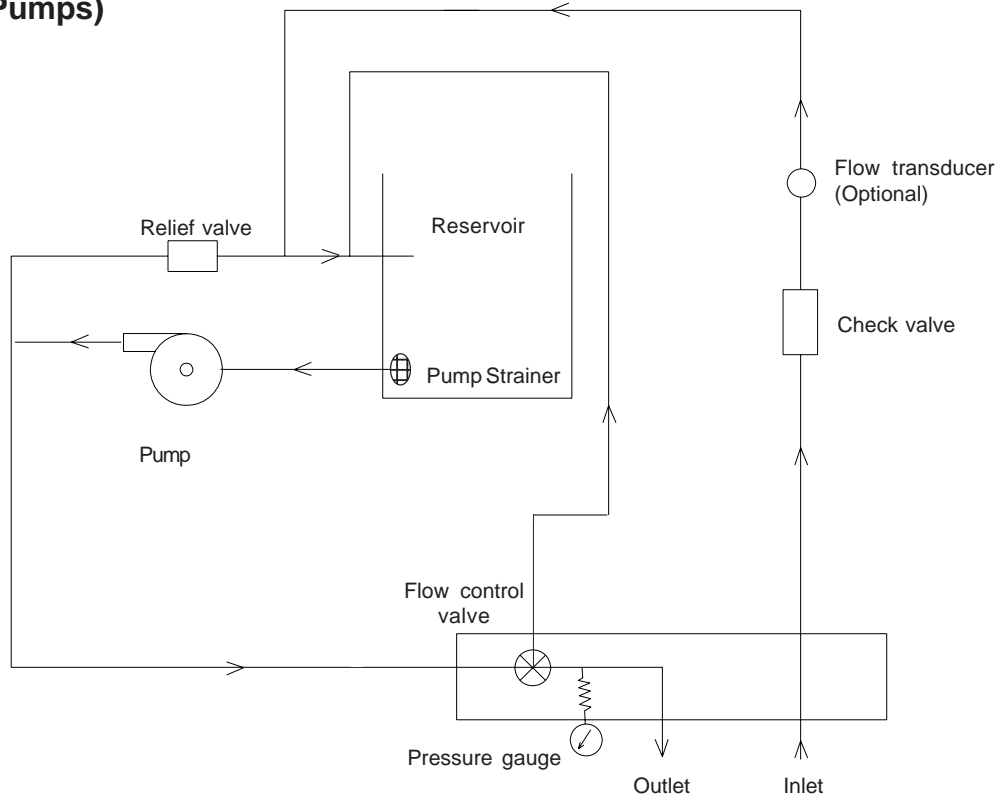

Dimensions

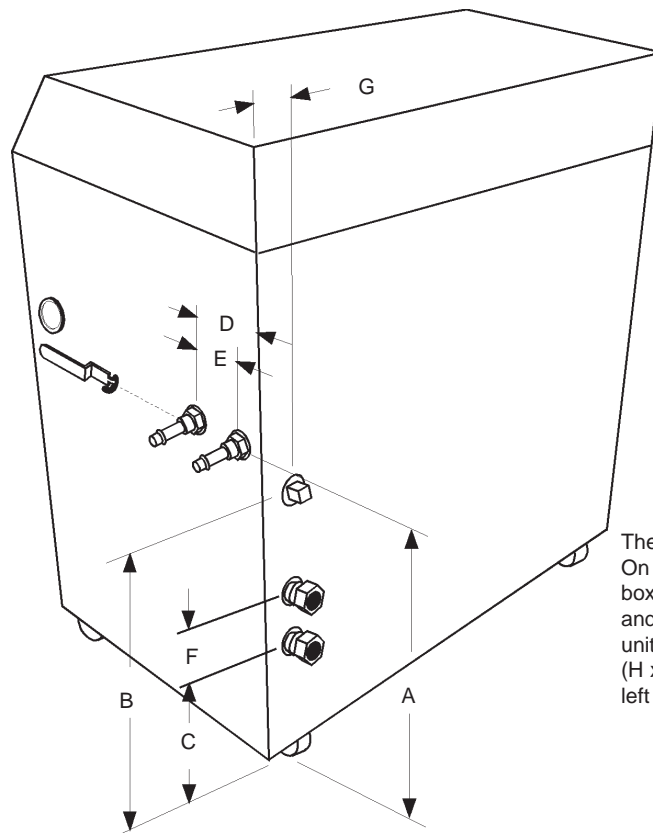

The pullbox comes in two sizes. On HX 300s, 500s and 750s the box is 12" x 16" x 4" (H x W x D) and is located on the rear of the unit. For all others it is 6" x 6" x 4" (H x W x D) and is located on the left side.

Unit Dimensions	HX 75	HX 150	HX 300	HX 500	HX 750AC*
<i>Dimension A</i>	16	20	25 ³ / ₈	25 ¹ / ₄	41
<i>Dimension B</i>	15 ¹ / ₄	19 ¹ / ₄	23 ¹ / ₂	21 ¹ / ₈	33 ³ / ₄
<i>Dimension C</i>	8 ¹ / ₄	9 ¹ / ₄	8 ³ / ₈	5 ¹ / ₂	NA
<i>Dimension D</i>	7 ¹ / ₄	7 ¹ / ₄	7 ¹ / ₂	9 ¹ / ₂	9 ¹ / ₂
<i>Dimension E</i>	3	3	3	3	3
<i>Dimension F</i>	3	3	3	5 ¹ / ₂	NA
<i>Dimension G</i>	1 ³ / ₈	1 ³ / ₈	1 ¹ / ₂	2 ¹ / ₄	NA
<i>Dimension H</i>	2 ¹ / ₂	2 ¹ / ₂	2 ³ / ₈	2 ¹ / ₄	2 ¹ / ₄
<i>Dimension I</i>	25 ⁷ / ₈	28 ¹ / ₂	32 ¹ / ₂	36 ¹ / ₈	36
<i>Dimension J</i>	48 ¹ / ₂	54	64 ⁷ / ₈	73 ¹ / ₂	86 ¹ / ₄
Crate Dimensions (H x W x D)	46x30x27	49x33x29	55x40x33	61x54x36	74x54x36

* Air-cooled units. Water-cooled units are the same size as the HX-500 units.

1. Dimensions are given in inches, ±1/8 inch.
2. Model HX 750 with a water-cooled condenser has the same dimensions as an HX 500.
3. Dimension A is the distance from the floor to the center of the SUPPLY and RETURN connections.
4. Dimension B is the distance from the floor to the center of the DRAIN connection.
5. Dimension C is the distance from the floor to the center of the facility water outlet connection.
6. Dimension D is the distance from the center of the SUPPLY connection to the rear of the unit case.
7. Dimension E is the distance between the SUPPLY and RETURN connections.
8. Dimension F is the distance between the center of the FACILITY WATER connections (upper inlet and lower outlet).
9. Dimension G is the distance from the edge of the unit case to the center of the three plumbing connections.
10. Dimension H is the distance from the floor to the bottom of the case, height of the castors (not shown).
11. Dimension I is the depth of the unit with the case top open (not shown).
12. Dimension J is the height of the unit with the case top open (not shown).

Section XI Wetted Materials

Fluid Path Plumbing

- 1 Stainless Steel
- 2 Brass
- 3 Copper
- 4 Nylon
- 5 Bronz
- 6 Silver
- 7 Antimony
- 8 Nickle
- 9 EPDM
- 10 Silicon
- 11 PVC

CP Pumps

- 1 Stainless Steel
- 2 Buna N
- 3 Graphite
- 4 Ceramic

TU Pumps

- 1 Bronze
- 2 Monel
- 3 Graphite
- 4 Buna N

PD-2 Pumps

- 1 Bronze
- 2 Stainless Steel
- 3 Graphite
4. Viton

WARRANTY

Thermo Fisher Scientific warrants for 12 months from date of shipment any Thermo Scientific product according to the following terms.

Any part of the unit manufactured or supplied by Thermo Fisher and found in the reasonable judgment of Thermo Fisher to be defective in material or workmanship will be repaired at an authorized Thermo Scientific Product Repair Depot without charge for parts or labor. The unit, including any defective part must be returned to an authorized Thermo Scientific Product Repair Depot within the warranty period. The expense of returning the unit to the authorized Thermo Scientific Product Repair Depot for warranty service will be paid for by the buyer. Our responsibility in respect to warranty claims is limited to performing the required repairs or replacements, and no claim of breach of warranty shall be cause for cancellation or rescission of the contract of sales of any unit. With respect to units that qualify for field service repairs, Thermo Fisher Scientific's responsibility is limited to the component parts necessary for the repair and the labor that is required on site to perform the repair. Any travel labor or mileage charges are the financial responsibility of the buyer.

The buyer shall be responsible for any evaluation or warranty service call (including labor charges) if no defects are found with the Thermo Scientific product.

This warranty does not cover any unit that has been subject to misuse, neglect, or accident. This warranty does not apply to any damage to the unit that is the result of improper installation or maintenance, or to any unit that has been operated or maintained in any way contrary to the operating or maintenance instructions specified in this Instruction and Operation Manual. This warranty does not cover any unit that has been altered or modified so as to change its intended use.

In addition, this warranty does not extend to repairs made by the use of parts, accessories, or fluids which are either incompatible with the unit or adversely affect its operation, performance, or durability.

Thermo Fisher Scientific reserves the right to change or improve the design of any product without assuming any obligation to modify any unit previously manufactured.

THE FOREGOING EXPRESS WARRANTY IS IN LIEU OF ALL OTHER WARRANTIES, EXPRESSED OR IMPLIED, INCLUDING BUT NOT LIMITED TO WARRANTIES OR MERCHANTABILITY AND FITNESS FOR A PARTICULAR PURPOSE.

Thermo Fisher Scientific's OBLIGATION UNDER THIS WARRANTY IS STRICTLY AND EXCLUSIVELY LIMITED TO THE REPAIR OR REPLACEMENT OF DEFECTIVE COMPONENT PARTS AND Thermo Fisher DOES NOT ASSUME OR AUTHORIZE ANYONE TO ASSUME FOR IT ANY OTHER OBLIGATION.

Thermo Fisher ASSUMES NO RESPONSIBILITY FOR INCIDENTAL, CONSEQUENTIAL, OR OTHER DAMAGES INCLUDING, BUT NOT LIMITED TO LOSS OR DAMAGE TO PROPERTY, LOSS OF PROFITS OR REVENUE, LOSS OF THE UNIT, LOSS OF TIME, OR INCONVENIENCE.

This warranty applies to units sold in the United States. Any units sold elsewhere are warranted by the affiliated marketing company of Thermo Fisher Scientific. This warranty and all matters arising pursuant to it shall be governed by the law of the State of New Hampshire, United States. All legal actions brought in relation hereto shall be filed in the appropriate state or federal courts in New Hampshire, unless waived by Thermo Fisher Scientific.



Artisan Technology Group is your source for quality new and certified-used/pre-owned equipment

- FAST SHIPPING AND DELIVERY
- TENS OF THOUSANDS OF IN-STOCK ITEMS
- EQUIPMENT DEMOS
- HUNDREDS OF MANUFACTURERS SUPPORTED
- LEASING/MONTHLY RENTALS
- ITAR CERTIFIED SECURE ASSET SOLUTIONS

SERVICE CENTER REPAIRS

Experienced engineers and technicians on staff at our full-service, in-house repair center

*InstraView*SM REMOTE INSPECTION

Remotely inspect equipment before purchasing with our interactive website at www.instraview.com ↗

WE BUY USED EQUIPMENT

Sell your excess, underutilized, and idle used equipment. We also offer credit for buy-backs and trade-ins. www.artisanng.com/WeBuyEquipment ↗

LOOKING FOR MORE INFORMATION?

Visit us on the web at www.artisanng.com ↗ for more information on price quotations, drivers, technical specifications, manuals, and documentation

Contact us: (888) 88-SOURCE | sales@artisanng.com | www.artisanng.com