



Artisan Technology Group is your source for quality new and certified-used/pre-owned equipment

- FAST SHIPPING AND DELIVERY
- TENS OF THOUSANDS OF IN-STOCK ITEMS
- EQUIPMENT DEMOS
- HUNDREDS OF MANUFACTURERS SUPPORTED
- LEASING/MONTHLY RENTALS
- ITAR CERTIFIED SECURE ASSET SOLUTIONS

SERVICE CENTER REPAIRS

Experienced engineers and technicians on staff at our full-service, in-house repair center

*InstraView*SM REMOTE INSPECTION

Remotely inspect equipment before purchasing with our interactive website at www.instraview.com ↗

WE BUY USED EQUIPMENT

Sell your excess, underutilized, and idle used equipment. We also offer credit for buy-backs and trade-ins. www.artisanng.com/WeBuyEquipment ↗

LOOKING FOR MORE INFORMATION?

Visit us on the web at www.artisanng.com ↗ for more information on price quotations, drivers, technical specifications, manuals, and documentation

Contact us: (888) 88-SOURCE | sales@artisanng.com | www.artisanng.com

STEELHEAD 1 CE97
30°C to 130°C
Stainless Steel
Heat Exchanger
w/ MODICOMM RS-485 (CHX)
Serial Communication
Model 620099991707

Thermo Manual P/N U00206
Rev. 06/11/04

Instruction and Operation Manual



STEELHEAD HEAT EXCHANGER

PREFACE

Compliance	2
Nameplate Data	2
Unpacking	2
After-sale Support	2

SECTION I SAFETY

Warnings	3
Material Safety Data Sheets	3

SECTION II GENERAL INFORMATION

Description	4
Specifications	4

SECTION III INSTALLATION

Site	5
Electrical Requirements	5
Safety Control Requirements	5
Plumbing Requirements	6
Facility Water Requirements	6
Fluids	6
Front Panel Gauges	7
Front Panel Controls	7
Low Profile Membrane Key Functions	9
LED Indicators	10
Controller Loops	12
Error Messages	15
MODICOMMRS-485 (CHX)	16
Serial Communication Specifications	16

SECTION IV OPERATION

Pre Start Up & Filling Requirements	18
Start Up & Shut Down	19
Changing a Value	20
Remote Operation	20
Temperature Control	21
Flow Control	21
Flow Monitors	21
Low Level Monitors	21
Resistivity and Temperature Sensor	21

SECTION V PREVENTATIVE MAINTENANCE

Service Contracts	22
General Guidelines	22
Daily Preventative Maintenance	24
Fluid Inspection/Draining	25
Fluid pH	25
Stainless Steel Particulate Filter	26
Barnstead DI Filter	26
Culligan DI Filter	27
Pump Motor Ball Bearing Lubrication	27
Reservoir Cleaning	27

SECTION VI TROUBLESHOOTING

Facilitization Problem Troubleshooting	28
Error Message Troubleshooting	30

SECTION VII DIAGRAMS

Flow Diagram	33
Fork Lift Channel Dimensions	34
Wiring Diagram	35

APPENDIX A

Remote Electronic Interface	A-1
-----------------------------------	-----

APPENDIX B

Quick Start Up Procedures	B-1
---------------------------------	-----

APPENDIX C

Using the AMAT Heat Exchanger Configuration Touch Screen	C-1
--	-----

Preface

Compliance

This product has been tested and found to be in compliance with the requirements defined in the EMC standards defined by 89/336/EEC as well as Low Voltage Directive (LVD) 73/23/EEC and the Machinery Directive 93/44/EEC . The testing has demonstrated compliance with the following directives:

LVD, 73/23/EEC	Complies with UL 3101-1:93 and IEC 1010-1
EMC, 89/336/EEC	EN 55011, Class A Verification
IEC 1000-4-2:1995	Electro-Static Discharge
IEC 1000-4-3:1994	Radiated Electromagnetic Field
IEC 1000-4-4:1995	Conducted Electrical Fast Transient/Burst
93/44/EEC	Machinery Directive

For any additional information refer to the Letter of Compliance that shipped with the unit (Declaration of Conformity).

Nameplate Data

MODEL: STEELHEAD 1	PHASE: 3/PE 4WIRE
FREQUENCY:	50/60 HERTZ
FULL LOAD AMPS:	23/25
HEATER: 6KW @ 208VOLTS	PUMP: 3.0 HP
LARGEST LOAD HEATER	16.7 AMPS
INTERRUPT CAPACITY:	10KA PER EN60898
10KAIC W/MAX 120 AMP FUSE PER UL1077	
MASS:	385LBS 174KG
ELECTRICAL DIAGRAM:	6.3259

Unpacking

Retain all cartons and packing material until the unit is operated and found to be in good condition. If the unit shows external or internal damage contact the transportation company and file a damage claim. Under ICC regulations, this is your responsibility.

After-sale Support

Thermo Electron Corporation is committed to customer service both during and after the sale. If you have questions concerning the operation of your unit, contact our Sales Department. Before calling, please refer to the serial number label on the rear of the unit to obtain the following information (see Section II, Description for serial number label location):

- *unit BOM number* _____
- *unit serial number* _____

Section I Safety

Warnings

Make sure you read and understand all instructions and safety precautions listed in this manual before installing or operating your unit. If you have any questions concerning the operation of your unit or the information in this manual, please contact our Sales Department (see After-sale Support).

Performance of installation, operation, or maintenance procedures other than those described in this manual may result in a hazardous situation and may void the manufacturer's warranty.

Transport the unit with care. Sudden jolts or drops can cause damage.

Do not attempt to move the unit without proper lifting or moving equipment — serious injury can occur.

Do not lift unit by the filter.

Observe all warning labels.

Never remove warning labels.

Never operate damaged or leaking equipment.

Never operate the unit without fluid in the reservoir.

Always lock the main circuit breaker in the OFF position, turn off the unit and disconnect the power supply from the power source before performing any service or maintenance, or before moving the unit.

Never operate equipment with damaged power cords.

Refer service and repairs to a qualified technician.

Some circuits in the enclosure will remain energized even with the line cord disconnected. Control voltages will be present. If repairs are authorized inside the enclosure, the main power and 15-pin plug must be removed from the unit.

In addition to the safety warnings listed above, warnings are posted throughout the manual. Read and follow these important instructions. Failure to observe these instructions can result in permanent damage to the unit, significant property damage, or personal injury or death.

Material Safety Data Sheets

Ethylene Glycol	Union Carbide Chemicals and Plastics Company Inc. Industrial Chemicals Division 39 Old Ridgebury Road Danbury, CT 06819-000 307-744-3487
Teflon® Paste	Hercules Chemical Company Passaic, NJ 07055-7398 1-800-221-9330
De-Ox Anti-Oxidant	IlSCO 4730 Madison Road Cincinnati, OH 45227 513-871-4000

If you have Internet access, you can access numerous MSDS forms via the EPA Chemical Substances Database.

Cornell Univ. has ~325,000 on line searchable MSDS at
<http://www.pdc.cornell.edu/issearch/msdssrch.htm>

Section II General Information

Description

The heat exchanger system consists of a thermal fluid recirculating system which provides a constant fluid flow. A second loop consists of a facilities water loop which recirculates through a plate heat exchanger for fluid cooling. A 6 kilowatt heater is located in the fluid recirculating system.

The recirculating fluid loop has a deionizing package with a replaceable cartridge and a 20 micron particulate filter with a replaceable filter element. A small plate heat exchanger is used to cool the fluid entering the deionizing cartridge.

Throughout the manual, you will be asked to consult the unit's serial number label for specific information. The label is located on the right of the control box.

Specifications

Temperature Range	30°C to 130°C
Reservoir Volume	5 Gallons 19 Liters
Unit Dimensions (Outer Envelope) (H x W x D)	32 x 20 ^{3/8} x 31 ^{3/8} Inches 812.8 x 517.5 x 796.9 Millimeters
Frame Dimensions (H x W X D)	28 ^{1/2} x 20 x 25 Inches 723.9x 508.0 x 635.0 Millimeters
Cooling Capacity¹	8KW @ 5.0 GPM Facility Water Flow Rate
Heating Capacity²	6KW @ 208V
Flow ³	8.0 Gallons/Minute 30.3 Liters/Minute
Pressure	30 to 60 PSI - 130 PSI Max

1. 22°C facility water with 2 - 8 GPM process water flow rate. 8°C or greater difference between process water and facility water.
2. 39 watts per square inch.
3. 15 meters from unit through ^{3/8} inch ID hose. Flow split equally between flow channels.

Section III Installation

Site

Locate the unit in a laboratory or clean industrial environment where ambient temperatures are inside the range of +10°C to +40°C (+50°F to +104°F).



Never place the unit in a location where excessive heat, moisture, or corrosive materials are present.

Excessively dusty areas should be avoided and a periodic cleaning schedule should be instituted.

Install the Steelhead unit on a level surface. The unit is equipped with locking casters on the front left and right rear of the unit to prevent movement. The unit is also equipped with adjustable leveling feet.



To prevent damage, raise the leveling feet to the full up position when not in use. Secure the leveling feet by securing the jam nut on the leveling foot shaft to the case bottom.

The unit is designed to stand alone or can also be stacked with another Steelhead unit, or a standard AMAT 0 or 1 heat exchanger. See the Fork Lift Channel Dimension Diagram in Section VII.

Electrical Requirements



The unit construction provides protection against the risk of electrical shock by grounding appropriate metal parts. It is the user's responsibility to assure that a proper ground connection is provided to the unit.

Rated Voltage: 200 to 208VAC, 50/60Hz, 3Ø

Rated Circuit: 30Amps

Make sure the voltage of the power source meets the specified voltage, ±10%.

Safety Control Requirements

EMERGENCY OFF guarded mushroom push-button with pull reset is provided to turn off the unit in case of an emergency. An EMERGENCY OFF connector is provided on the top left portion of the rear of the unit to include the system into the emergency off circuit. An isolated set of normally closed contacts is provided for the EMERGENCY OFF safety circuit. Contact rating is 60AMP make and 10AMP break at 24VAC.

The EMERGENCY OFF safety connector receptacle port is part number AMP 206061-1. The mating plug part number is AMP 206060-1 which uses sockets part number AMP 66101-1.

Plumbing Requirements

The plumbing connections are located on the bottom rear of the unit and are labelled THERMAL FLUID CHAMBER #1, #2, #3, #4. The four THERMAL FLUID SUPPLY (to the tool) connections have ½" quick disconnect nipples. The four THERMAL FLUID RETURN (from the tool) connections have ½" quick disconnect couplers.

Keep the distance between the heat exchanger system and your application as short as possible, and use the largest diameter tubing practical. Tubing should be straight and without bends. If diameter reductions are needed make them at the inlet and outlet of your application, not at the heat exchanger system.

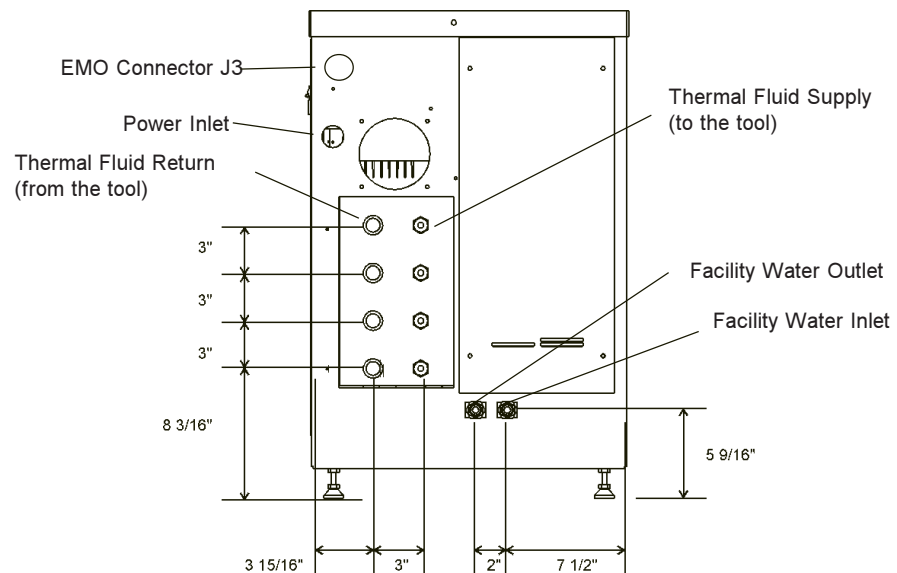

Facility Water Requirements

Facility water inlet and outlet connections are located at the bottom-center-rear of the unit and are labelled FACILITY WATER. The facility water connections are 3/8" (Parker push-loc male hose nipples).

Fluids



Never use flammable or corrosive fluids with this unit. Do not use automobile anti-freeze. Commercial anti-freeze contains silicates that can damage the pump seals and cause leaks. Use of automobile anti-freeze will void the manufacturer's warranty.

The unit is designed to use a **100% electronic grade ethylene glycol** as the thermal fluid. Change the fluid as required, see Section V.

Front Panel Gauges

1. Pump Pressure. Reads the pressure at the outlet of the unit.
2. Filter Pressure Gauge. The filter cartridge should be cleaned/replaced when the gauge reads 1Bar (15psi) more than the pump pressure gauge.

Front Panel Controls

Main Disconnect Circuit Breaker

30 Amp, 3 Pole 10 KAIC used to locally disconnect main power at the unit.

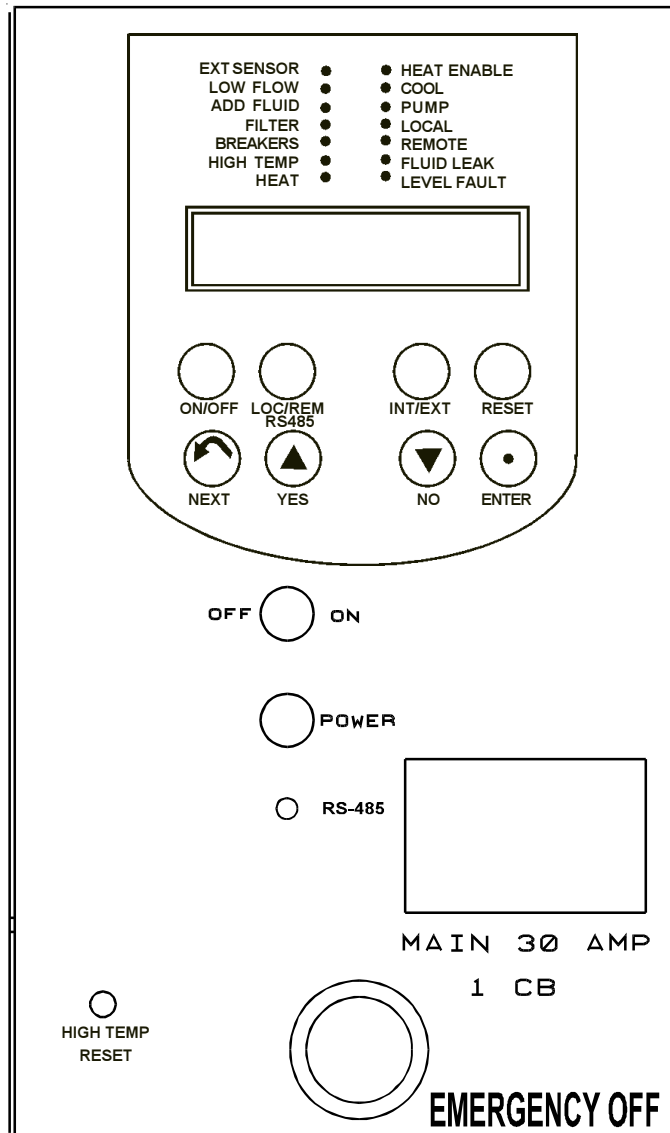

Pad Lock - Lockout

When the unit is not in use or is being serviced, the Pad Lock - Lockout should be used. The lockout requires a padlock with a 3/4" diameter shackle.

POWER - Amber

The POWER light indicates that the main disconnect circuit breaker is on, power is available, and the control and secondary circuit breakers (in the electrical enclosure) are on.

RS485

The RS485 light indicates that the serial communication mode (MODICOMM/RS485) is active. The light flashes each time a query is received.

ON/OFF

Turning the ON/OFF rotary switch to the ON position enables the unit. The controller illuminates and runs a diagnostic test, and then the unit enters the standby mode.

Turning the ON/OFF rotary switch to the OFF position disables the unit.

NOTE: The machine circuit is interlocked to the electrical enclosure so the removal of the panel will turn off the unit and the controller.

HEATER HIGH TEMPERATURE MANUAL RESET

The HEATER HIGH TEMPERATURE MANUAL RESET button allows the heater high temperature switch to be reset once the temperature is below the Heater High Temperature setting.



Resetting the button will automatically start the unit if the unit is in the ON mode.

J1

DB-15 Female Connector. J1 connects to the standard AMAT 5000 Heat Exchanger Interface. See Appendix A for connector and pinout information.



Supplying the wrong voltage to any of the remote interface pins can seriously damage the controller. Verify that the cable is plugged into the correct port on the AMAT tool before beginning remote operation.

J2

DB-9 Female Connector. J2 connects to an approved AMAT temperature probe for external temperature control, display and temperature feedback signal.

J4 & J5

DB-9 Female Connectors. Configured for RS485 and MODICOMM Serial Communication Protocol.

Low Profile Membrane Key Functions

ON/OFF

The **ON/OFF** key toggles the controller from on to off and vice versa. The controller will not switch to the ON mode unless proper conditions exist inside the unit. See Error Messages in this section.

LOC/REM RS485

The **LOC/REM RS485** key toggles the unit from local to remote to RS485 operation. The RS485 mode is serial communication.

INT/EXT

The **INT/EXT** key switches between the internal and external RTD probe. Display #1 will alternate from INT T XXC to EXT T XXC. The control of the fluid temp will switch from internal RTD probe to the external RTD probe. If there is no external probe the controller will continue to display and to control from the internal RTD probe.

RESET

The **RESET** key will attempt to clear the Add Fluid or Change Filter condition status.

NEXT

The **NEXT** key is used to sequence through the controller displays.

YES

The **YES** key is used to increment values displayed on the controller.

NO

The **NO** key is used to decrement values displayed on the controller.

ENTER

The **ENTER** key is used to accept values displayed on the controller.

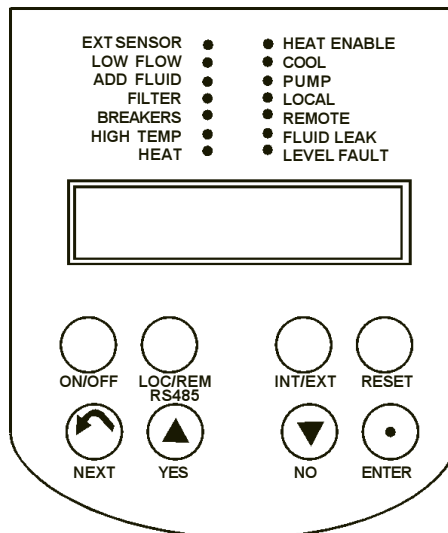

LED Indicators

EXT SENSOR - Amber

When this is lit the controller is using the external RTD probe to control the fluid temperature and Display #1 EXTT XXXC is shown. When it is not lit the controller is using the internal RTD probe.

LOW FLOW - Amber

This LED is lit whenever any flow drops below the flow setpoint. Also, whenever a low flow condition exists a signal is sent to the tool through P1. The low flow condition status and LOW FLOW LED is turned off automatically when the low flow condition returns to above the setpoint, or when the flow is disabled in the setup mode.

ADD FLUID - Amber

This LED is lit and an add fluid signal is sent to the tool whenever there is approximately 3¾ gallons left in the tank. The ADD FLUID LED goes out and the signal to the tool is automatically removed when the add fluid condition is corrected.

NOTE: When the ADD FLUID LED is on and the digital signal to the tool goes high (open circuit), fill the unit using the procedures and cautions mentioned in this manual or equipment damage or safety shut down of the heat exchanger could occur.

FILTER - Amber

This LED is lit when the particulate fluid filter has been in service for six months. This signals the operator to change the filter. The LED goes out and the filter timer is reset when the **RESET** key is depressed. **NOTE:** The **RESET** key will not reset the filter timer unless the FILTER LED is lit.

BREAKERS - Amber

This LED is lit whenever the pump circuit breaker or the heater circuit breaker is tripped. An ERROR message PUMP TRIP or HEAT TRIP will also flash on the display. The BEAKERS LED will go out and the error message will stop flashing whenever the error condition is corrected.

A heat breaker trip condition will light the BREAKERS LED and flash the HEAT TRIP warning message. A heat breaker condition will clear itself automatically when the condition is corrected.

A pump breaker trip condition will light the BREAKER LED, flash the PUMP TRIP warning message and turn off the HEAT ENABLE LED. The BREAKER LED will go out, the PUMP TRIP warning message will stop and the HEAT ENABLE LED will turn on when the pump breaker trip condition is corrected.

HIGH TEMP - Amber

This LED is lit whenever a high temperature condition exists. When this condition is detected the controller turns off the unit and illuminates the HIGH TEMP LED. When the high temperature condition is corrected press the heater high temperature reset switch to automatically restart the unit.

HEAT - Amber

This LED is on steady when the controller is supplying 100% heat. The HEAT LED is off when the controller is not supplying any heat. The HEAT LED flashes when the controller is controlling the temperature inside the heat PID proportional band.

HEAT ENABLE - Green

This LED is lit whenever the controller is on and conditions are proper for allowing heat to be supplied to the fluid.

The following conditions are needed for the HEAT ENABLE LED to light.

1. **ON/OFF** mode must be **ON**
2. There is no high temperature condition
3. Pump signal on

COOL - Green

This LED is on steady when the controller is supplying 100% cooling to the fluid. The LED is off when the controller is not supplying any cooling to the fluid. The LED flashes when the controller is controlling temperature by cooling inside the cool PID proportional band.

PUMP - Green

This LED indicates the status of the pump control logic.

In the REMOTE mode, the LED is lit whenever the pump on signal from the tool is on and the controller ON/OFF status is ON. 24VDC must be supplied to pin 10 of P1.

In either the LOCAL or REMOTE mode, pressing the control ON button will turn on either the LOCAL or REMOTE LED (whichever has been previously selected). Pressing the controller ON button again will turn both the LOCAL and REMOTE LED off.

NOTE: The machine circuit is interlocked to the electrical enclosure so the removal of the panel will turn off the unit and the controller.

LOCAL - Green

This LED is lit whenever the controller is in the local mode and is off when the controller is in the remote mode, as selected by the **LOC/REM** key (ON mode only).

REMOTE - Green

This LED is lit whenever the controller is in the remote mode and is off when the controller is in the local mode, as selected by the **LOC/REM** key (ON mode only).

FLUID LEAK - Amber

This LED is lit whenever a leak is detected by the controller.

LEVEL FAULT - Amber

This LED is lit when the controller detects two gallons remaining in the tank. When a low level condition is detected the controller disables the heater and turns off the HEAT ENABLE LED. Once the condition is corrected it must be cleared with the **RESET** key before the heater will be enabled.

Controller Loops

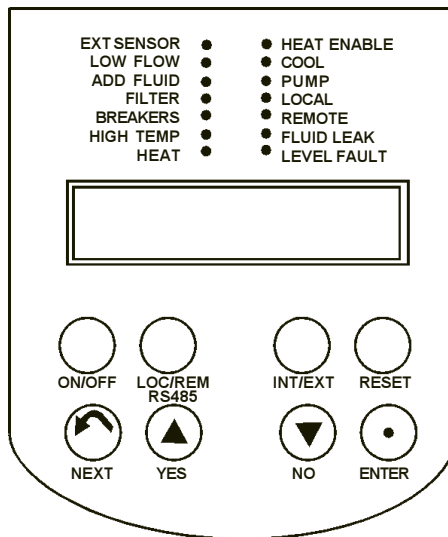

Two controller loops allow the operator to display and/or alter different parameters of the controller. The loops can be accessed from the temperature display by pressing and holding the key combinations shown on Figure 1 below.

When the controller is first powered up it goes through a short self test and then enters the Operator's Loop, displaying the reservoir fluid temperature.

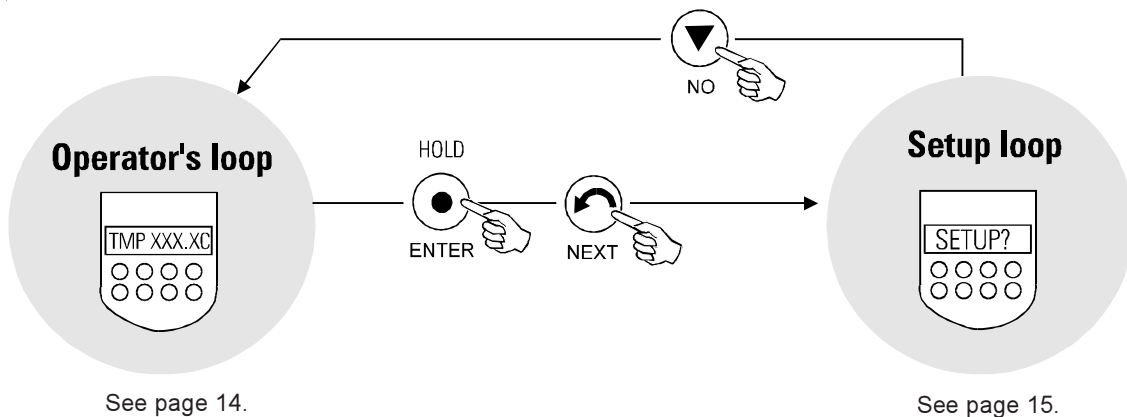

Figure 1 Changing Loops

Operators Loop

When the controller is first powered it goes through a short self test and then enters the Operator's Loop, displaying the reservoir temperature as measured by either the internal or external RTD probe.

By pressing the NEXT key the controller will step through the menu shown below.

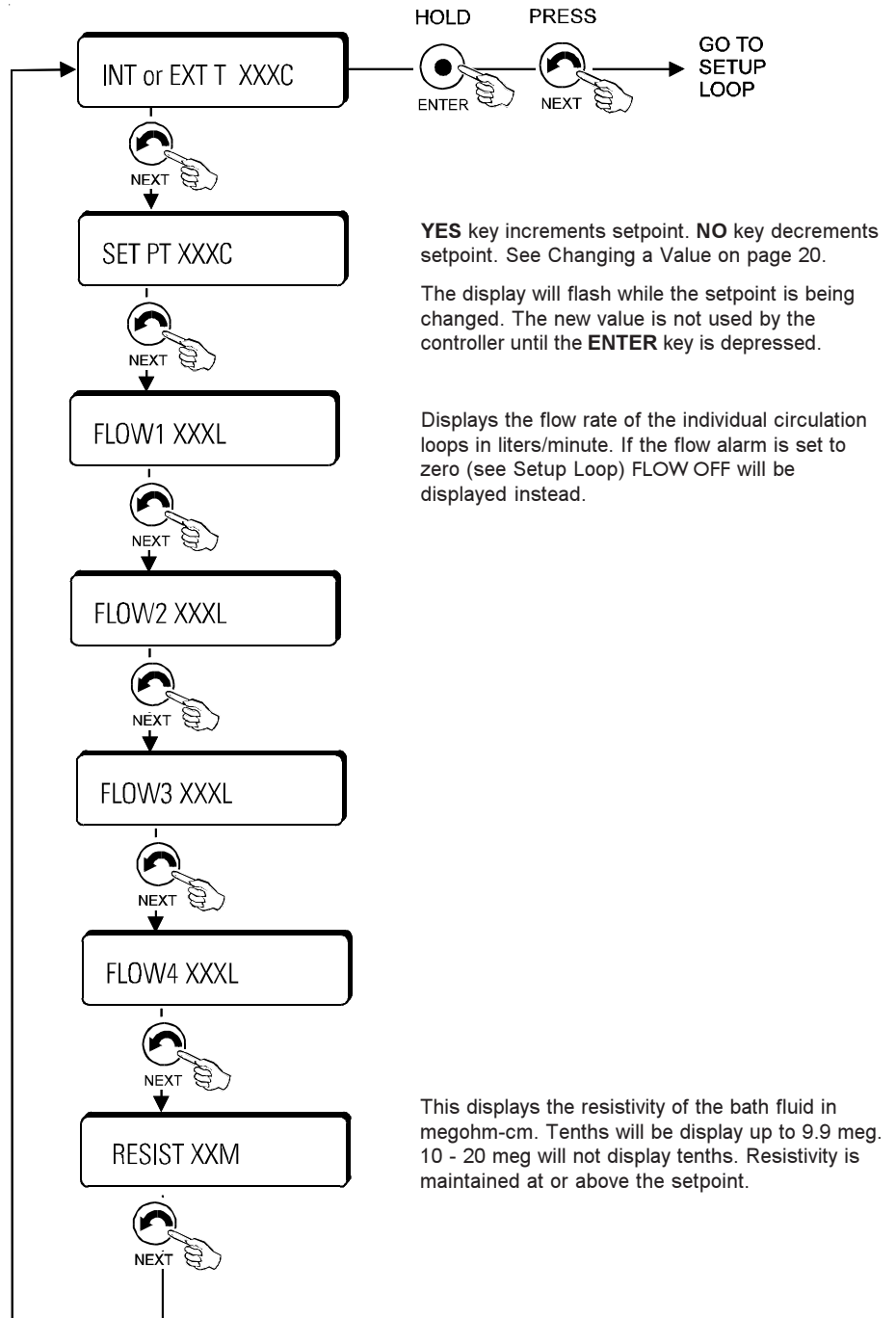

Figure 2 Operator's Loop

Setup Loop

The Setup Loop allows the operator to change the flowrate setpoints. To enter this loop you must be in the Operator's Loop and displaying the temperature. Depress and hold the ENTER key while pressing the NEXT key. Follow the menu shown in Figure 3.

Each of the four flows can be set independently. The controller compares this value to the actual flow of the circulation loop. If the actual flow drops below the alarm value, the controller signals a low flow condition. If the alarm is set to zero, the flow checking for the circulation loop will be disabled and the operators loop display will display FLOW X OFF.

Adjust values with the UP and DOWN arrows. See Changing a Value on page 20. Press ENTER then NEXT for the controller to accept each new entry.

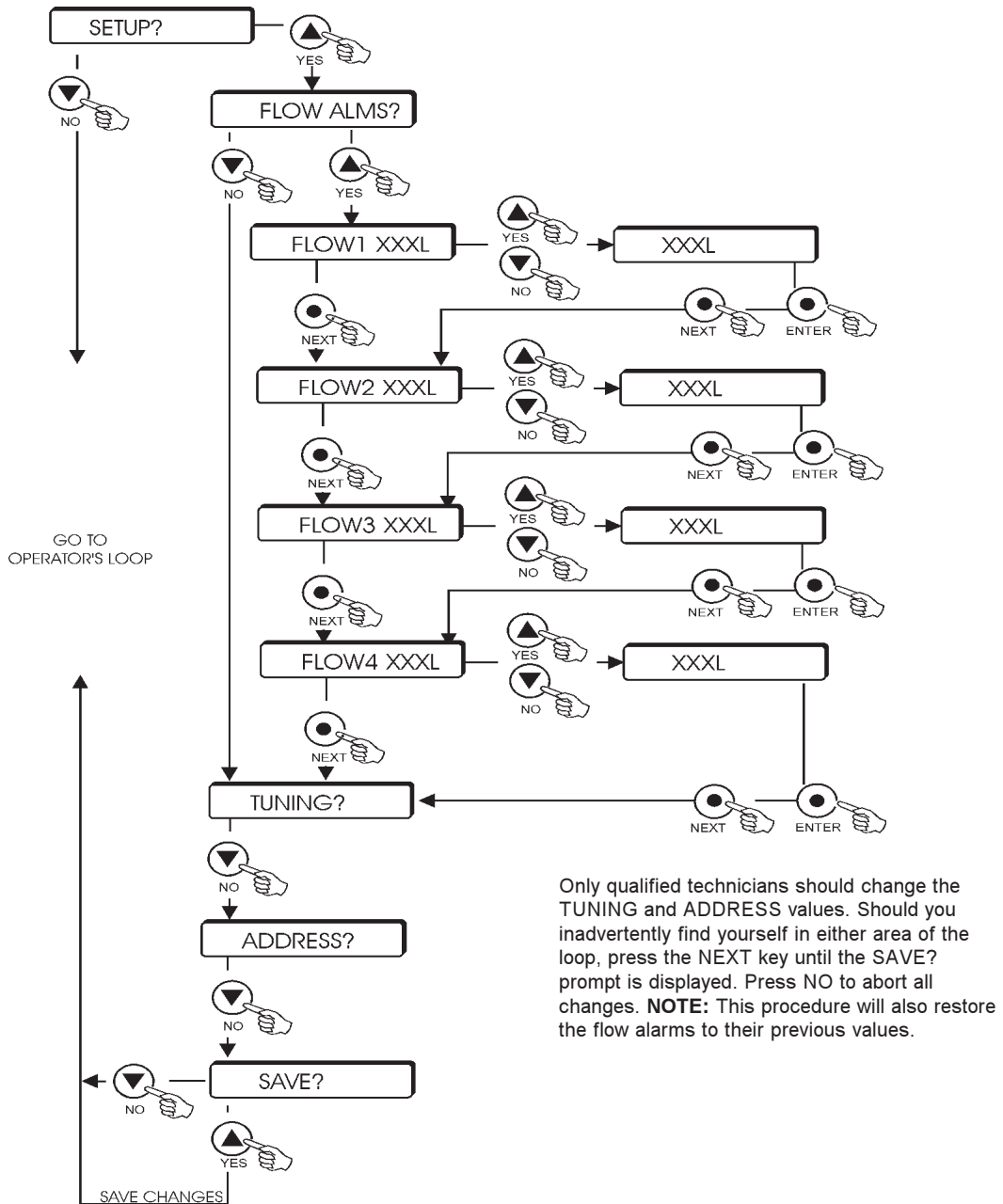

Figure 3 Setup Loop

ERROR Messages

Error messages are displayed whenever certain conditions are detected. When this occurs the error message will be displayed by alternating the error message and the normal display. The keys and menus will perform normally.

All error messages, except for OVER TEMP, disappear when the error condition is corrected. Corrective action for all error messages is listed in the Maintenance Section of this manual.

PHASE ERR

This message is displayed whenever the controller senses a phase error or missing phase coming into the unit. This condition will not allow the controller to switch to ON.

24V OFF (Remote Mode Only)

This message is displayed whenever the controller loses the 24 volt input signal from the tool. This signal loss turns off the unit and will not allow the controller to switch to ON.

PUMP TRIP

This message is displayed whenever the controller senses the pump circuit breaker has tripped.

PUMP OVRLD

This message is displayed whenever the controller senses a pump motor overload condition.

HEAT TRIP

This message is displayed whenever the controller senses the heater circuit breaker has tripped.

PUMP CNTL

This message is displayed whenever the controller senses a pump controller error condition. This condition causes the heater to be disabled and turns off the PUMP LED.

HEAT CNTL

This message is displayed whenever the controller senses a heat control error condition. This condition disables the heater.

RTD FAIL

This message is displayed whenever the internal temperature probe has failed, i.e. shorted or opened, and the probe is controlling (displaying) temperature at the time of failure. This condition stops heating and cooling but the pump continues to operate. This condition automatically resets.

OVER TEMP

This message is displayed whenever the controlling temperature, i.e. INT T or EXT T, goes beyond 140°C. This condition will turn off the heat exchanger. The unit will be in the standby mode and will not restart until power is cycled to the controller.

MODICOMM RS485 (CHX) Interface

Author: Applied Materials.
 Title: Heat Exchanger Serial Communication.
 ID #: 0250-35965.
 Date: 2/28/97.
 Revision: A.

Serial Communication

When the controller is in the ON mode, depressing the RS485 local/remote pushbutton releases control of temperature setpoint to the MODICOMM (CHX) interface. The interface can also be used to turn the unit on and off.

Outputs are provided for fluid level, fluid flow, resistivity and fluid temperature. There are also digital outputs for fault summary and warning summary.

Serial Communication Specification

Connection Point

The RS-485 connector is a nine pin, metal shell "D-connector" with female pins, mounted on the back of the unit with 4-40 threaded jack sockets. J4 and J5 are connected in parallel to accommodate "daisy chain" connections.

RS-485 connector pinout information

Pin 5	Ground
Pin 9	T+
Pin 1	T-

Configuration

Number of heat exchangers per heat exchanger controller	1
Base address (in 4X memory) for the input segment	0
Input segment size	9
Base address (in 4X memory) for the output segment	9
Output segment size	6

Optional Digital Input Points

Digital Input Point 1	Fluid level fault	(1=fault, 0=OK)
Digital Input Point 2	Fluid flow fault	(1=fault, 0=OK)
Digital Input Point 3	not used	
Digital Input Point 4	not used	
Digital Input Point 5	Fuse fault	(1=fault, 0=OK)
Digital Input Point 6-32	reserved	

Optional Analog Input Points

Analog Input Point 1	Fluid resistivity, engineering units are MOhm-cm
Analog Input Point 2	Fluid flow rate, engineering units are gpm
Analog Input Point 3-5	reserved

Number of Configurable Digital Input Points.	0
Number of Configurable Analog Input Points.	0
Number of Configurable Digital Output Points.	0
Number of Configurable Analog Output Points.	0

Analog range values

These are scaling ranges only. The heat exchanger does not need to meet this range for operation.

	Number	Name	eu_lo	eu_hi
REQUIRED INPUT	1	Actual temperature	-60° C	160° C
OPTIONAL INPUT	1	Fluid resistivity	0 MW-cm	20 MW-cm
OPTIONAL INPUT	2	Fluid flow rate	0 GPM	10 GPM
REQUIRED OUTPUT		Temperature set point	-60° C	160° C

Configurable Names	NOT APPLICABLE
Configurable Terminology	NOT APPLICABLE
Configurable Engineering Units	NOT APPLICABLE

Heat Exchanger Controller's 4X memory map

4X Adrs.	Description		
100	Required Digital Inputs	1..2	(2 used; 14 not used)
101	Required Analog Input	1	(Actual temperature)
102	Optional Digital Inputs	1,2,5	(3 used; 2 not used; 11 reserved)
103	Optional Digital Inputs		(16 reserved)
104	Optional Analog Input	1	(Fluid resistivity)
105	Optional Analog Input	2	(Fluid flow rate)
106...108	Optional Analog Inputs		(3 reserved)
109	Required Digital Output	1	(1 used; 15 not used)
10A	Required Analog Output	1	(Temperature set point)
10B	Optional Digital Outputs		(16 reserved)
10C...10E	Optional Analog Outputs		(3 reserved)

Fault Summary (Digital Input Point 1 is the logical OR of these conditions): Fault condition shuts unit down.

Pump circuit breaker open fault

Pump overload fault

Pump TRIAC fault

Fluid major leak fault

Power phase error fault

Fluid low level fault

Fluid high temperature fault

Warning Summary (Digital Input Point 2 is the logical OR of these conditions)

Heater circuit breaker open warning

Heater TRIAC warning

Internal RTD warning

Fluid low flow warning

Reference

Applied Materials Serial Communication Specification No. 0250-35965, 4/28/97 Rev. A.

Section IV Operation

Pre Start Up & Filling Requirements



Whenever removing the fill cap or refilling the unit release any built up pressure in the reservoir by opening the manual air bleed valve. When refilling the heat exchanger should be running or the chamber quick disconnects detached from the unit so fluid will not run back from the lines or application to the reservoir and create an over-spill condition.

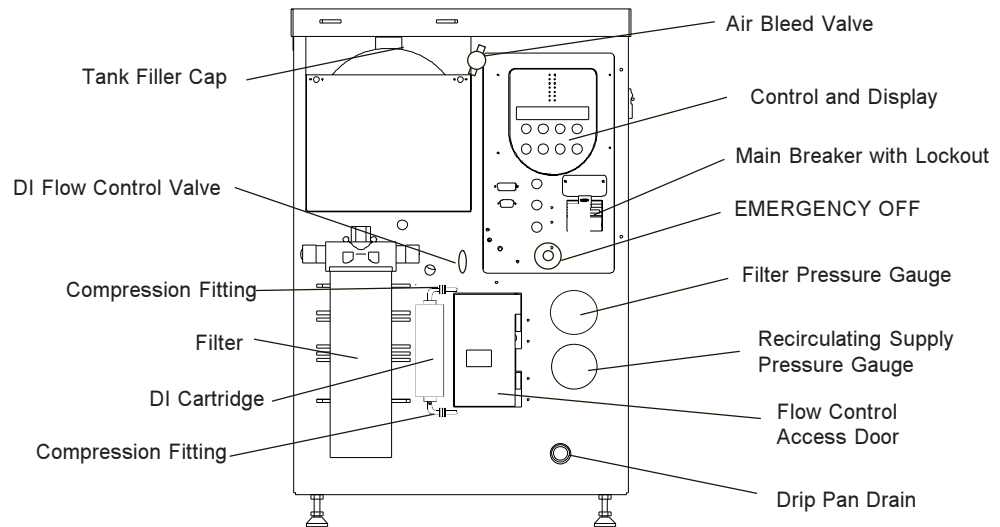

Ensure that the deionizer (DI) cartridge is installed and that the DI flow control valve is in the OPEN position. **NOTE:** Use the flow meter, located on the rear of the unit, to regulate flow control to meet your DI requirements.

Turn the main breaker on and the amber POWER LED will light. Turn the ON/OFF rotary switch to ON.

Remove the 1¼" filler cap from the top of the reservoir. Using a funnel, carefully fill the reservoir with recirculating fluid. If the units are stacked, the lower unit will need a funnel with an extended flexible neck (due to the proximity of the filter on the upper unit).

NOTE: Immediately stop filling when the ADD FLUID LED extinguishes.

Replace the filler cap on the reservoir. Also, close the manual bleed valve located to the right of the tank fill fitting.

Depress the RESET button to remove the level fault and extinguish the LEVEL FAULT LED.

The amount of recirculating fluid needed depends on the total requirements of your system. Also, if substantial lengths of recirculating lines are used, add enough fluid to compensate for their volume. The maximum reservoir volume is 5 gallons (19 liters).

NOTE: When refilling, the heat exchanger should be running or the chamber quick disconnects detached from the unit so fluid will not run back from the lines or tool to the reservoir to create an over-spill condition.

Start Up & Shut Down



Before starting unit make sure the flow control valve located behind the access door on the front of the unit is closed to prevent excessive start-up pressures. The valve handle should be in the upright position. After the unit has started, open the valve until the desired flow and pressure is observed on the front panel displays.

Before starting check all electrical connections and ensure the plumbing connections are correctly made to the ten fittings on the rear of the unit. Ensure that the DI flow control valve is the OPEN position.



Ensure cooling water is always available to the unit.

Turn the main breaker on and the amber POWER LED will light.

Turn the OFF/ON rotary selector switch to ON. The controller will initiate a self-diagnostic with all segments of the display flashing and all LEDs sequentially lighting. After the last LED lights, the controller should display INT T XXXC (XXX is the temperature after the pump discharge). The LOCAL or REMOTE LED illuminates to indicate the unit is in the ON mode. If an error message appears and flashes see Error Messages on page 15.

The LOW FLOW LED will be lit. If more fluid is needed both the LEVEL FAULT and ADD FLUID LEDs will flash. To turn the unit on press the ON/OFF button on the controller membrane.

NOTE: The unit will not start until the LEVEL FAULT and ADD FLUID conditions are cleared and the ON/OFF button is depressed.

In LOCAL the unit will start immediately, if there are no faults. In REMOTE the unit will only start when the appropriate interface connections are made.

Certain other fault error messages will also inhibit start up. They are: PHASE, PUMP TRIP, PUMP OVERLOAD, PUMP CONTROL, RTD FAIL, and OVERTEMP. A heater high temperature, indicated by the HIGH TEMP LED illuminating, will also inhibit start up.

NOTE: The unit may need additional fluid as the plumbing starts to fill.



To avoid premature depletion of DI cartridge resins, always run the unit with the tank filler cap on and the bleed valve shut.

With the unit running use the operator's menu to view the fluid temperature, change the setpoint (LOCAL mode only) and monitor flow. Scroll through the operator's menu using the NEXT key.

Turn the unit off by depressing the ON/OFF controller membrane button.

Changing a Value

The **YES** key increments the value. The **NO** key decrements the value.

The display will flash as soon as either key is depressed, and continue to flash until the **ENTER** key is pressed to accept the new value.

The new value will not be used by the controller until the **ENTER** key is depressed and the display stops flashing.

If the **NEXT** key is pressed while the value is flashing, the new value will not be accepted. The display will stop flashing and the original value will be displayed. In this case the **NEXT** key is used to abort data entry. The display will not sequence unless the **NEXT** key is depressed.

For large values the display can be changed by manipulating the individual digits. Press the **YES** key and the **NO** key at the same time. The most significant digit will start to flash. Press the **YES** key to increment, or the **NO** key to decrement the digit. Press the **ENTER** key to accept the digit and to move to the next least significant digit. Repeat until all the digits are entered. Pressing the **NEXT** key before entering all the digits will abort the procedure and return the display to the original value.

The controller will not allow you to enter a value above the maximum or below the minimum values, or any illegal value. If you try to enter an illegal value the display will revert to its original value when the last digit is entered.

Remote Operation



Verify that the remote interface cable is connected to the correct interface port on the tool. If the interface cable is plugged into the incorrect port on the tool, the Steelhead controller can be damaged.

When the controller is in the ON mode and the REMOTE pushbutton is depressed, the controller will relinquish PID control of temperature to the standard AMAT 5000 platform interface. The unit can be turned on and off by the remote interface. When controlled from the remote interface, the temperature can be controlled by software provided by the AMAT 5000 platform.

In addition to remote control the interface provides digital indication of the add fluid level, the flow status, and an analog signal of recirculating fluid temperature and resistivity.

See Appendix A for the details on the AMAT 5000 platform interface control of the heat exchanger.

Temperature Control

Fluid temperature control is achieved by activating a chilled-water solenoid valve and a tank heater. PID microprocessor algorithms control both the valve and heater, unless in the remote mode where control of the valve and heater is from the host unit.

Flow Control

Flow control is achieved by adjusting the flow control valve to the desired flow and pressure. The valve is located behind the front bottom access door.

Flow Monitors

Each recirculating THERMAL FLUID RETURN line is each equipped with a flow sensor. The sensor confirms proper flow returning from your application.

The flow sensor provides an opto-isolated current sinking transistor output at the P1 connector for flow rates above one gallon per minute. The signal is absent at flow rates below one gallon per minute.

Each channel's flow setpoint value can be changed or turned off for the full operating range of the flow monitor, see page 14.

Low Level Monitors

There are two level switches in the reservoir. When the fluid level drops to 3¾ gallons, the ADD FLUID lamp on the side of the unit will illuminate and a signal is sent to the tool. If the fluid level should drop to 2.0 gallons, the LEVEL FAULT LED illuminates and the heater is disabled.

If the fluid level drops to two gallons the LEVEL FAULT LED illuminates and the heater is disabled. If a LEVEL FAULT occurs within three minutes after an ADD FLUID fault, the unit shuts down and the LEVEL FAULT LED will flash. It is not possible to start the unit in any mode with an active LEVEL FAULT. The fault clears automatically once the reservoir is refilled. The ON/OFF button must be pressed to start the unit.

Resistivity & Temperature Sensor

A resistivity and temperature sensor is located in the recirculating process fluid outlet line. The sensor provides output voltages to J1 pins 7 and 8 which are proportional to temperature and resistivity respectively.

Pin7	Temperature Readout 0 - 10V = 0 - 100°C
Pin6	Temperature Readout Common
Pin8	Resistivity Out 0 - 16 megohm-cm 3.4 VDC full scale
Pin11	Resistivity Out Common

Section V Preventative Maintenance



For personal safety and equipment reliability, the following procedures should only be performed by a qualified technician. Contact our Service Department for assistance (see Preface, After-sale Support).



Shut down the system and lock the main circuit breaker in the OFF position before attempting any preventative maintenance.



Do not remove the bleed off resistors from the capacitor filter. Capacitors carry a residual charge after power down.

Service Contracts

Thermo NESLAB offers on-site Service Contracts that are designed to provide extended life and minimal downtime for your unit. For more information, contact our Service Department (see Preface, After-sale Support).

General Guidelines

NOTE: Each chiller/tool application contains its own set of variables, potentially increasing or decreasing the frequency of action items. See Fluid Degradation Risk Assessment Chart on the next page.



Uninhibited Ethylene glycol (EG) degrades over time and starts to corrode metal. Draining the system alone will not remove corrosion by-products. Use system pressure to flush all the components.



EG is hygroscopic, it will absorb water from its environment. This can affect the freezing point and boiling point of the fluid over time. This may result in system failure.



Top-off the system with Uninhibited EG. Do not “top-off” with water. Topping-off with plain water can severely affect the freezing point and boiling point of the fluid. This may result in system failure.

Fluid Degradation Risk Assessment Chart *

Uninhibited Ethylene Glycol in Steelhead Heat Exchanger

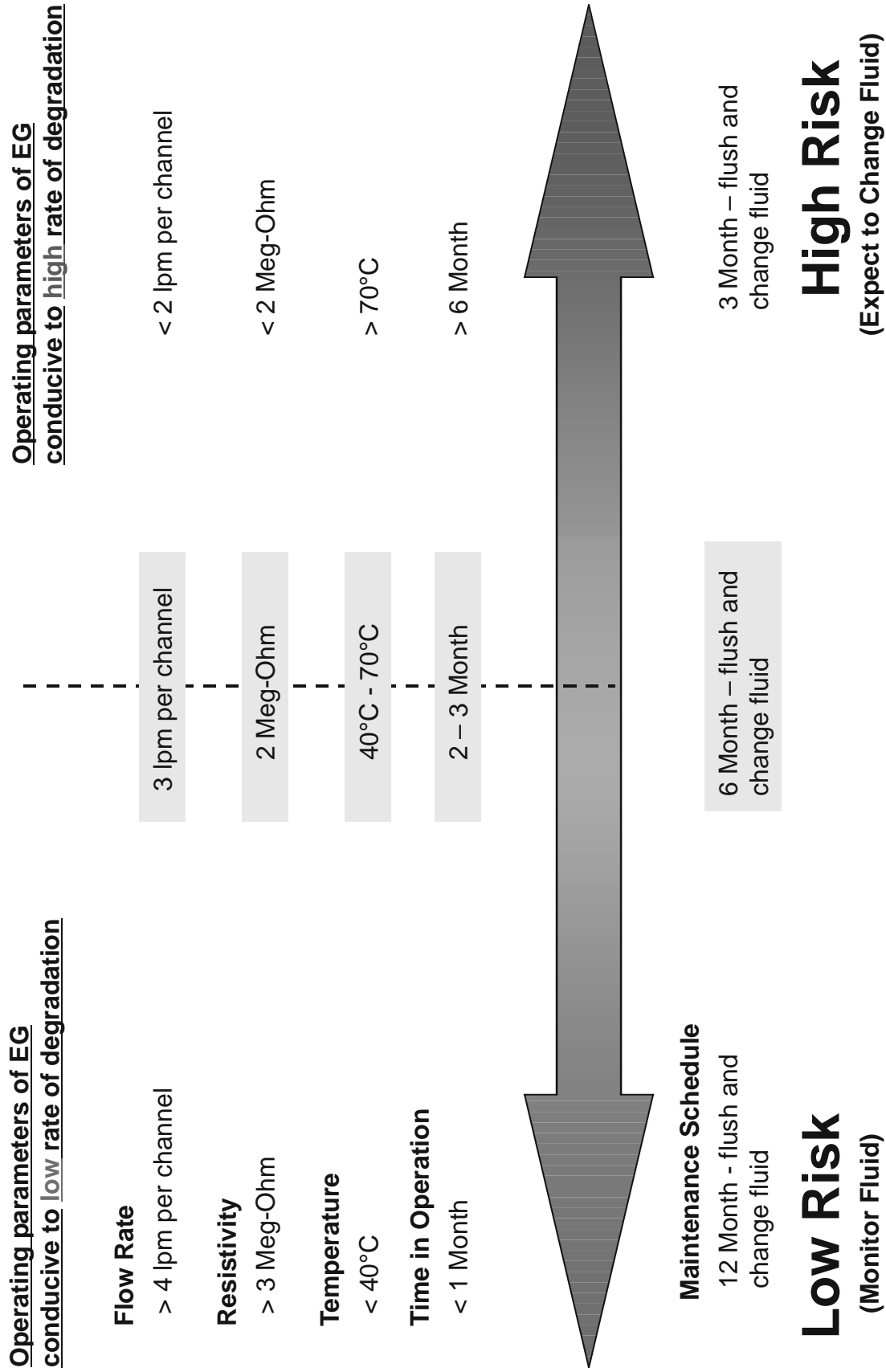

* Contact Thermo NESLAB for further details supporting fluid issues in high temperature applications.

ACTION	Daily	Weekly	Every 3mos	Every 6mos	Every 12mos
Check Controller	x				
Check Flow Indicators	x				
Check ADD Fluid LED	x				
Check Drip Pan	x				
Check Fault Indicator	x				
Inspect Fluid		x			
Measure Fluid pH		x			
Clean Particulate Filter Element				x or $\Delta P > 15 \text{psi}$ see text	
Change Barnstead DI Filter			x or RES < desired level see text		
Change Culligan DI Filter					x or RES < desired level see text
Lubricate Pump Motor Bearings				x	
Clean Reservoir					x

Daily Preventative Maintenance

CONTROLLER DISPLAY Check for any error messages.

LOW FLOW Normal indication if one of the loops is not in use, otherwise at least one of the flows is below its alarm setpoint. Check that flow setpoints are correct. Check for correct pump operation. Check for flow obstructions.

ADD FLUID Check for leaks and improper tank sealing. Add fluid until LED extinguishes.

FLUID LEAK The unit drip pan is accumulating facility water or recirculating fluid. Immediately locate the cause of the leak and turn off the unit if a failure is eminent. Repair leak or replace unit.

LEVEL FAULT Verify there are no leaks in the system. Add fluid until LED extinguishes. Run unit and recheck for leaks.

Fluid Inspection/Draining



Failure to remove corrosion by-products or particles in your system may rapidly lower resistivity, clog the particulate filter, and result in damage to the mechanical seals contained in the unit's pump.

Because Uninhibited EG contains no corrosion inhibitors, the fluid must be inspected weekly for visual signs of degradation. New, Uninhibited EG should be clear and colorless. The fluid should be replaced at the first sign of deviation from its clear and colorless appearance.



Before changing the fluid, lower the operating temperature of the unit to prevent injury from contact with the hot temperature fluid. Use proper fluid handling and disposal techniques.

Drain & Flush Protocol

1. Drain the Thermo NESLAB unit, connection lines, and tool. If necessary, use system pressure to flush the Thermo NESLAB unit, connection lines, and tool.
2. Clean new or lightly corroded existing systems (chiller, connection lines, and tool) with a 1-2% trisodium phosphate solution. Flush with Uninhibited EG if trisodium phosphate is not available.
3. Repeat if necessary until there are no signs of particles exiting from the system.
4. Perform a final rinse with your application Uninhibited EG.
5. For extensively corroded existing systems that is beyond self-help, contact a professional industrial cleaning company, one who has experience in cleaning industrial machinery and in performing repairs or replacement of components.

Fluid pH



Uninhibited ethylene glycol can become corrosive in as little as three weeks. This is a function of the temperature, oxygen concentration, and metals exposed to the fluid.

Uninhibited EG normally has a pH of 5.5 - 8.0, *depending on the specific glycol manufacturer*. Please refer to your specific manufacturer of Uninhibited EG for their recommendation for fluid change-out.

Particulate Filter Element (Part# 008371)

If debris is drawn into the system, the filter prevents the material from being ingested into the fluid loop. As the filter collects particles, it creates a pressure drop in the flow loop. This pressure drop is measured by comparing the filter pressure with the main pressure on the gauges located on the front of the unit. Clean the filter if the pressure difference is greater than 15 psi (1.1 kg/cm²).

Before replacing the filter element, relieve any tank pressure by activating the bleed valve located just right of the filler port. Close the flow control valve located behind the front access door and disconnect the supply lines from the rear of the unit.

Drain the cannister. The drain is located on the bottom of the cannister.

Using the filter tool attached to the side of the unit, loosen the ring nut on the filter head clockwise until free. *Slowly* lower the cannister towards you to remove it from the unit. **NOTE:** A small amount of fluid may drain from the line. Remove and replace the filter element.

Ensure both top and bottom O-rings in the cannister are in place and properly oriented. The rounded side faces the filter, see illustration of cross section.



Install a new head gasket (016859) on the filter head. Reinstall the cannister.

Replace the ring nut. Tighten using the filter tool until the housing contacts the filter head. Check for leaks.

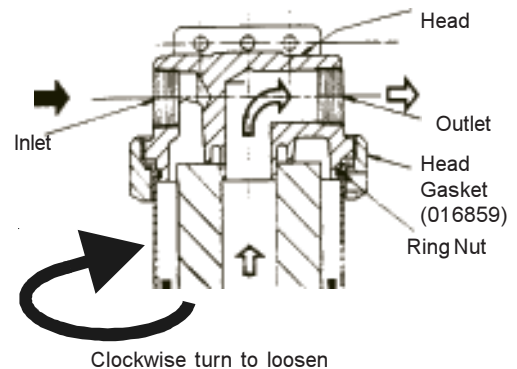

Barnstead DI Filter (Part# 008699)

Change the Barnstead deionization (DI) filter when the resistivity of the fluid drops below the desired level. Typical cartridge life is 3 months. Actual cartridge life depends on the system application, fluid quality and the desired minimum DEI level.

The DI flow valve controls flow to and from the cartridge. The DI flow control valve is above the unit's DI cartridge. The valve has a small green handle, see illustration on page 18. Close the valve handle.

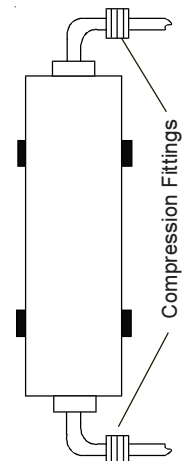

Relieve any tank pressure by activating the bleed valve. The valve is located just right of the filler port, see illustration on page 18.

Loosen the compression fitting nuts on the top and bottom of the cannister. Remove the fittings from the old cartridge and wrap threads with 3 - 4 turns of Teflon® tape. Install the fittings on the new cartridge.

Reconnect the compression nuts. *Do not overtighten.*

Open the valve and check for leaks. If leaks are present, slightly tighten the compression nuts and check again. Repeat as necessary.

NOTE: To avoid premature depletion of the DI resins, always run the unit with the tank filler cap on tight and the bleed valve shut.

Culligan DI Filter (Part# 026272)

Not all units are equipped with this filter. Change the Culligan deionization (DI) filter when the resistivity of the fluid drops below the desired level. Typical cartridge life is 12 months. Actual cartridge life depends on the system application, fluid quality, and the desired minimum DEI level.

If the resistivity remains low the resistivity probe may need cleaning/replacement. Contact Thermo.

NOTE: Excessive flow through the DI will prevent the unit from reaching higher temperature set points. Thermo recommends monitoring the DI level and adjusting the flow rate to produce the desired value.

Pump Motor Bearings Lubrication

Lubricate the pump motor bearings every six (6) months. Two bearing lubrication Alemite fittings are located at the top front and bottom rear of the motor. Clean tip of fittings and apply grease gun, use one to two full strokes per fitting.

Tools Required: Screw driver to remove the left side panel, grease gun with long flexible hose.

Grease Type: Polyurea

Typical Grease: Shell Dolium BRB

Reservoir Cleaning

Clean the reservoir every twelve (12) months or sooner if visual inspection shows signs of contamination. If cleaning is necessary, flush the reservoir with a cleaning fluid compatible with the circulating system and the recirculating fluid.

Section VI Troubleshooting

Facilitization Problem Troubleshooting

Customer-related problems have occurred on NESLAB Steelhead Heat Exchangers during facilitization or start up at Applied Materials and its customers. Although there were no defects with the Steelhead units, NESLAB has developed the following reference guide to help minimize reoccurrence of these problems. This guide lists potential facilitization problems, possible causes for these problems, and lists several items to check before rejecting the unit or contacting NESLAB service.

If the problem remains, if you have any questions regarding the information in this table, or if you require assistance from NESLAB, contact our Service Group at (800) 4NESLAB.

Problem	Possible Cause	Recommendation
Unit will not heat above a certain temperature (i.e., ~30°C)	<ol style="list-style-type: none">1. The facility water lines are hooked up incorrectly. If the inlet and outlet lines are reversed, the facility water will flow continuously in heat mode, especially with a high temperature setpoint.2. Excessive flow through DI loop.	<ol style="list-style-type: none">1. Verify that the facility water lines are correctly hooked up.2. Regulate DEI valve towards the off position. Monitor flow rate using the flow meter on the rear of the unit.
In Remote Mode, the temperature output signal reads a constant temperature (0-15°C), that is not equal to the setpoint.	The remote interface cable is connected incorrectly at the tool. If the voltages supplied through the remote interface are incorrect, the main control board in the unit may be damaged.	Verify that the remote interface cable is correctly connected at the tool. If incorrectly installed, contact NESLAB service to replace the damaged main control board.
Pump pressure or flow is deteriorated.	<ol style="list-style-type: none">1. The filter cartridge may be dirty. If the filter is clogged this will reduce pump performance. Filter changing is part of routine maintenance.2. The flow control valve may not be set to meet the tool's needs. This valve allows adjustment of the flow and pressure.	<ol style="list-style-type: none">1. Check the filter pressure gauge on the front of the unit. If the pressure reading is outside the tolerance listed in this manual, the filter may need to be changed.2. Adjust the flow control valve to the desired setting.
The unit will not maintain a resistivity level, or the resistivity level is always zero.	The resistivity cartridge is exhausted or the thermal fluid is heavily contaminated. Replacing the resistivity cartridge to maintain a resistivity level is part of routine maintenance.	Install a new resistivity cartridge. If an increase in resistivity does not occur, flush out the thermal fluid system (including lines to the tool), and fill with new fluid.

Problem	Possible Cause	Recommendation
Flow alarm will not clear.	NESLAB factory sets all four flow alarms to 3.8 lpm. It is possible that flow alarm setpoints for loops not in use are not set to zero, or flow alarm for loops in use may be set too high.	Verify the alarm setpoint for the process loops not in use are set to zero (off). Verify that the alarm setpoints for the process loops in use are set to the desired value.
Unit leaks at the facility inlet/outlet, reservoir drain, filter cartridge drain, or the DEI cartridge.	The fittings may not be tight enough or Teflon® tape is not applied, causing leakage.	These fittings are used during facilitization should be prepared and tightened in accordance with the instructions in this manual.
Fluid in filter cannister or DEI cartridge appears contaminated.	The thermal fluid specified for use in the Steelhead unit family naturally degrades over time. This degradation can cause fluid contamination and possible damage to the unit if the fluid is not regularly replaced. Fluid replacement is part of routine maintenance for the unit.	Flush out the thermal fluid loop (including the lines to the tool) and replace with new fluid as specified in this manual.
Temperature calibration appears to be off, either in remote or local mode.	Because of temperature gradients inside the unit and heat transfer to the environment through the fluid lines, the temperature at the tool may be different than the temperature at the unit.	Contact NESLAB service for a field verification of temperature calibration .
Unit has missing or bent leveling foot.	Leveling foot jam nut not tightened securely to case. This could cause foot shaft to loosen and lower. The lowered leveling foot could become bent during movement of the unit or could fall out completely.	Ensure all leveling foot jam nuts are securely tightened to the case.
CB trips during ramp to set point.	Excessive flow through DI loop, causing excessive heater draw.	Regulate DEI towards off position.

Error Message Troubleshooting



Actions listed below should be performed only by a competent technician. Contact NESLAB Service for assistance.

Error Message	Type	Indication	Action
OVER TEMP	Failure	Unit will not run, Unit turned off due to fluid temperature limit exceeded.	Check that pump is running, check cooling solenoid operation, verify actual temperature of fluid and temperature display.
PHASE ERR	Failure	Unit will not run, Incorrect phase rotation, Low voltage, Voltage unbalance, Loss of phase.	Check for correct voltages, reverse main power phasing if necessary.
24V OFF (Remote mode only)	Failure	Unit will not run, 24Vdc return not available from AMAT interface.	Check that customer 15 pin interface is properly connected and that 24 Vdc is across pins 10 and 9.
PUMP TRIP	Failure	Unit will not run. Pump circuit breaker tripped or opened.	Check for shorts on the pump circuit, or if circuit breaker is closed and error persists,
PUMP OVRLD	Failure	Unit will not run. Pump motor overload relay has tripped, BREAKERS led is lit.	Check that motor overload setting is at least FLA of motor and less than SFA of motor, adjust if needed. Reset motor overload and measure motor current for each phase line under normal running conditions. Investigate pump overload.
RTD FAILED	Failure	Unit will continue to run in the on mode with heat and cool functions disabled. In the off mode the controller indicates the failure.	Check that the RTD probe is not shorted or opened. Check the RTD board input by placing a resistor in place of the RTD.
PUMP CNTL	Failure	Controller will not start or will not stop the pump.	Check main control board pump triac for short or open, check pump control circuit wiring.
HEAT TRIP	Failure	Heater will not enable. Heater circuit breaker tripped or opened, BREAKERS led is lit.	Check for shorts on the heater circuit. Check heater current on each phase line, normal rating is 16.7 Amps at 208 Volts.
HEAT CNTL	Failure	Controller will not enable or disable the heater contactor.	Check main control board heater triac for short or open, check heater control circuit wiring.

Error Message	Type	Indication	Corrective Action
BAD CAL	Warning	Flashes BAD CAL for several seconds after a calibration has been performed outside of the calibration zone allowed for a standard RTD. Protects against potential calibration errors.	Redo calibration of RTD until values are acceptable.
EXT SENSOR	Status	Unit is controlling temp with a remotely located RTD probe.	None.
LOW FLOW	Warning	At least one of the flows is below its alarm setpoint.	Assure that flow loops not used are turned off. Check that flow setpoints are correct. Check for correct pump operation. Check for flow obstructions.
ADD FLUID	Warning	Fluid level is low in reservoir.	Check for leaks. Check for improper sealing of the tank. Add fluid.
FILTER	Warning	Six months since filter has been cleaned or replaced. Counts as long as controller has power.	Clean or replace filter, Perform 6 month PMI.
BREAKERS	Failure	Heater and/or pump breaker is open.	See Error Message.
HIGH TEMP	Failure	Heater HTC tripped or malfunctioned, the unit will not run.	Adjustable HTC: Increase HTC setting and reset Fixed Temp. HTC: Reset HTC and check operation.
HEAT	Status	Controller is asking for the heater solid state relays to turn on.	None.
HEAT (Flashing)	Status	Controller is maintaining temp control within the proportional band by asking the solid state relays to turn on and off.	None.
HEAT ENABLE	Status	Controller is asking for the heater contactor to turn on.	None.

Continued on next page.

Error Message	Type	Indication	Corrective Action
COOL (Steady)	Status	Controller is asking for the cooling solenoid to turn on.	None.
COOL (Flashing)	Status	Controller is maintaining temperature control within the proportional band by asking the solenoid valve to turn on and off.	None.
PUMP	Status	The pump is on either locally or remotely.	None.
LOCAL	Status	The unit is on and in the local mode.	None.
REMOTE	Status	The unit is on and in the remote mode.	None.
FLUID LEAK	Failure	The unit drip pan is accumulating facility water or recirculating fluid.	Immediately locate the cause of the leak and turn off the unit if a failure is eminent. Repair leak or replace unit.
LEVEL FAULT (Steady)	Failure	Heater is disabled, unit will continue to operate. If unit is off the unit will not turn on.	Add Fluid until the ADD FLUID led goes out when reset.
LEVEL FAULT (Flashing)	Failure	Unit is off and will not turn on. Fluid level went from an ADD FLUID warning to a LEVEL FAULT within three minutes.	Check for fluid leak in system. The fault will reset once the reservoir is filled past the ADD FLUID level.

Flow Diagram

Section VII Diagrams

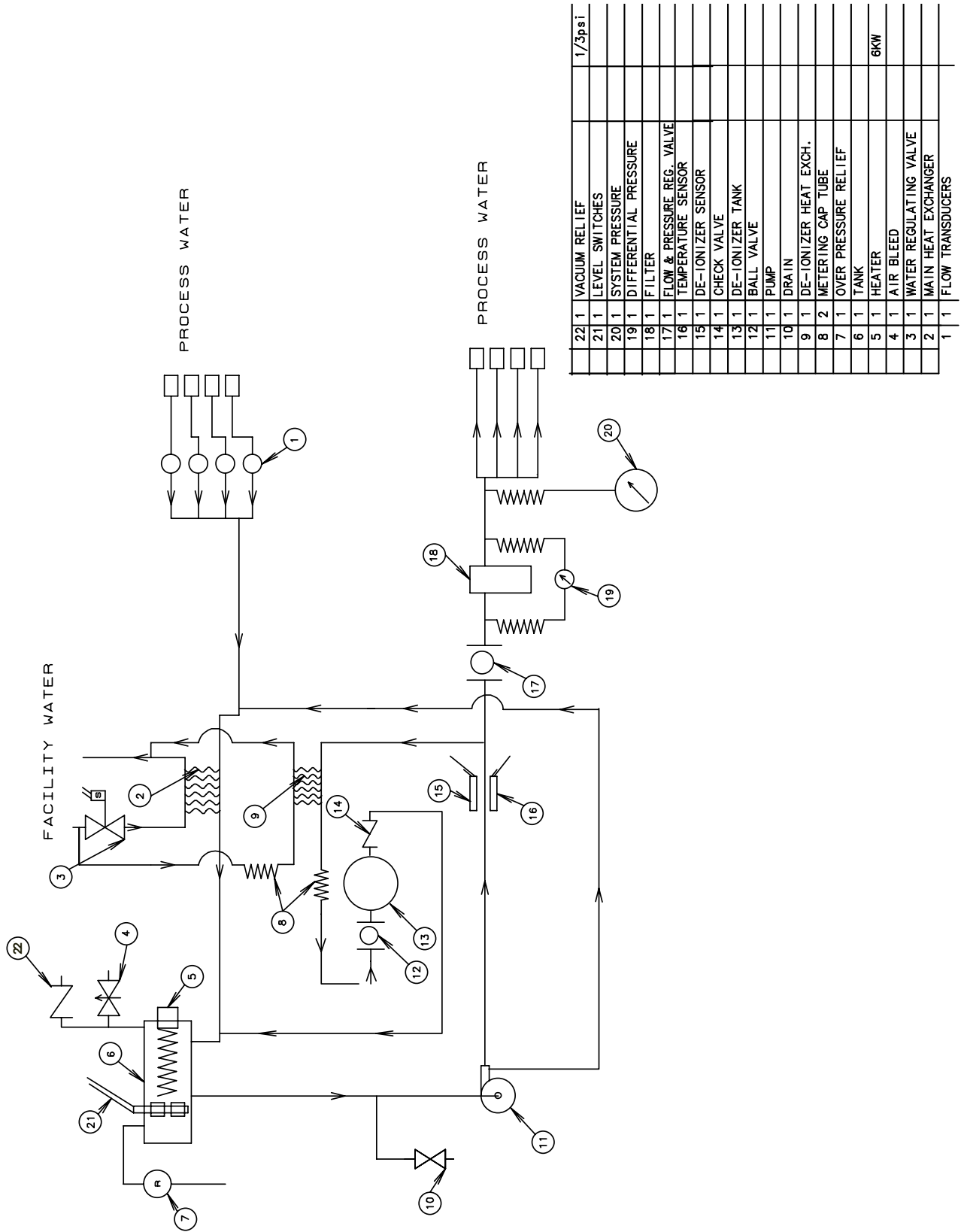

Fork Lift Channel Dimensions

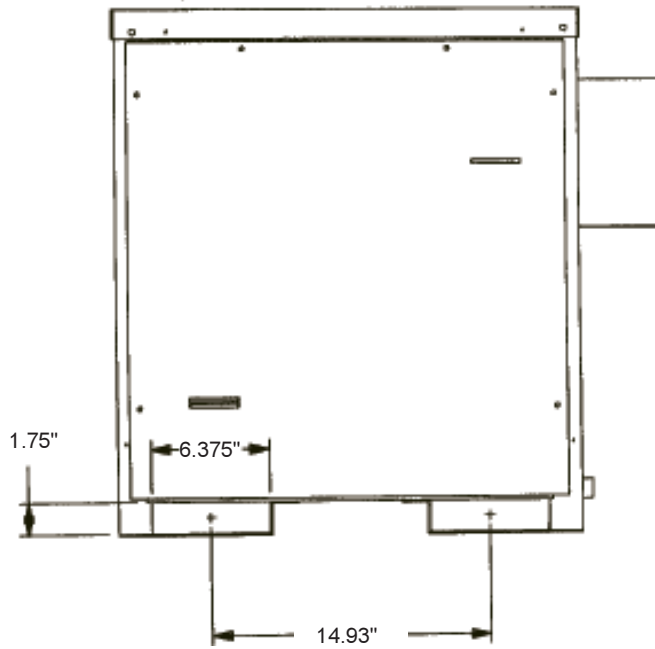

Appendix A - Remote Electronic Interface

STANDARD AMAT 5000 PLATFORM INTERFACE

The Steelhead unit is designed to operate like the AMAT heat exchanger. The interface cable should be connected to the AMAT HEAT EXCHANGER port of the AMAT tool.



Connecting the Steelhead to the NESLAB HEAT EXCHANGER port will damage the Steelhead controller.

Based on the specification given by Charles Pennington of Applied Materials for out sourcing the Steelhead 1 and 0 heat exchangers, the NESLAB controller can be upgraded to other types of serial communications by addition of the communications board and a connector to the rear of the unit with associated cabling.

Connector Type: Female D-Subminiature (DB 15S) Connector

AMAT Standard 5000 Platform Interface Pinout (Inputs and Outputs are to the heat exchanger)

Pin 1	Digital Output	Thermal Fluid Flow
Pin 2	Digital Output	Thermal Fluid Level in Reservoir
Pin 3	Digital Input	Heater Control Signal
Pin 4	Digital Input	Facility Water Valve
Pin 5	Digital Input	Pump Power Control
Pin 6	Analog Common	Referenced to Pin 7
Pin 7	Analog Output	Temperature Read Out
Pin 8 ¹	Analog Output	Resistivity Readout
Pin 9	Digital Common	24 VDC Common
Pin 10	Digital Power Supply	+24 VDC
Pin 11	Analog Common	Referenced to pin 8
Pin 12	Analog Power Supply	+15 VDC (we do not use)
Pin 13	Analog Power Supply	- 15 VDC (we do not use)
Pin 14	Analog Common	Referenced to Pin 15
Pin 15	Analog Input	Temperature Setpoint (5000 and 5200 platforms supply no signal)

1. Older versions - constant 10 volts.

Continued on next page

*Each unit has local and remote temperature control.

*Remote temperature control is done from the microprocessor of the 5000 platform and the NESLAB heat exchanger relinquishes control of the heater, cooling valve and pump control to the 5000 platform.

*The connector is accessible with the covers installed.

*The digital signal opto-isolated inputs to the heat exchanger use a current of less than 30 milliamps at a voltage of 0 to 1VDC. A 3 kohm resistor is in series with the input.

*The digital signal opto-isolated inputs to the heat exchanger use a current of less than 0.25 milliamps at a voltage of 18 to 24VDC.

*The digital outputs are open collector opto-isolated transistors that can sink up to 30 milliamps with VCE max of 30 VDC

*The temperature read out analog signal can supply up to 5 milliamps at a voltage of 10 VDC

*The analog signals are common at the heat exchanger controller and are isolated from ground by a transformer. (Connector J1 pins 6, 11, and 14 are common at the controller.)

*The temperature read out analog signal is linear where 0 to 10 VDC = 0 to 150°C.

*The resistivity read out analog signal scale is nonlinear. Resistivity range: 0-16 megohm-cm 3.4VDC full scale.

*The remote setpoint function is not used on a standard 5000 platform interface. The wiring for a remote setpoint signal is available on the NESLAB interface where -5 VDC to + 10 VDC can be programmed to whatever temperature range desired.

Appendix B Quick Starting Procedures

Before starting

1. Assure filter housing is appropriately tightened.
2. Assure resistivity filter is in place and its fittings are tight.
3. Units are shipped with new particulate filter elements installed. Assure that used units have the correct filter elements installed.

Start up procedure

1. Connect facility water lines.
2. Connect the thermal fluid supply and return to each chamber used.
3. Connect line cord to appropriate 200-208 Volts, 50 or 60 Hz, 3Ø, 30Amp Circuit.
4. Main breaker ON, and power available.
5. Turn rotary switch to ON. Controller will light up and go through diagnostics. No fault messages on controller display.
6. Fill unit until ADD FLUID LED extinguishes. **Use 100% Electronic Grade Ethylene Glycol.**
7. Press the ON/OFF button on the controller to start the unit.
8. After the unit has started, set the flow control valve until the desired flow and pressure is observed on the front panel displays.
9. Add additional fluid if the lines and application need to be filled.
10. Run the unit in LOCAL.
11. Put the setpoint at 30°C and assure cooling water is available to maintain temperature control.
12. Turn off flow alarms of chamber loops not being used.

With the display indicating INT T XX.XC, press and hold the ENTER key while pressing the NEXT key. The display will indicate SETUP?. Press the YES key and the display will indicate FLOW ALMS?. Press the YES key and the display will indicate FLOW1 XX.XL. (The controller default value is 3.8 lpm.) To scroll past any of the flow values press NEXT. Setting the flow alarm value to zero turns off that flow alarm. Press the YES and NO keys to change the value. When the desired value is displayed, press ENTER. Set all flow alarm values to zero if the chamber loop is not used in the application. After scrolling past the fourth flow alarm, the display will ask for TUNING?, press NEXT and the display will show TEMP OUT?. Press NEXT again and the display will show RES OUT?. Press NEXT and the display will show SAVE? Press YES to accept the entered values or NO to retain the original values before changing.

Note: The PID values are factory preset. Do not change unless authorized.

13. Unit is now ready for use.

Appendix C Using the AMAT Heat Exchanger Configuration Touch Screen

Shown in the figure below is an example of the AMAT Heat Exchanger Configuration Touch Screen. There are eight boxes on each screen labelled HX1, HX2, HX3, HX4, HX5, HX6, HX7 and HX8.

NOTE: Although the software has eight boxes, only two heat exchangers can be directly controlled.

To configure:

Select AMAT 1&2 in the upper right hand corner of the box.

Designate which chamber wall or cathode is attached to the heat exchanger.

26-Jul-1996 Applied Materials Precision 5000-4950 10:12:07
System Wafer Chamber A Chamber B Recipe Control Program Service

Heat Exchanger Maintenance Screen

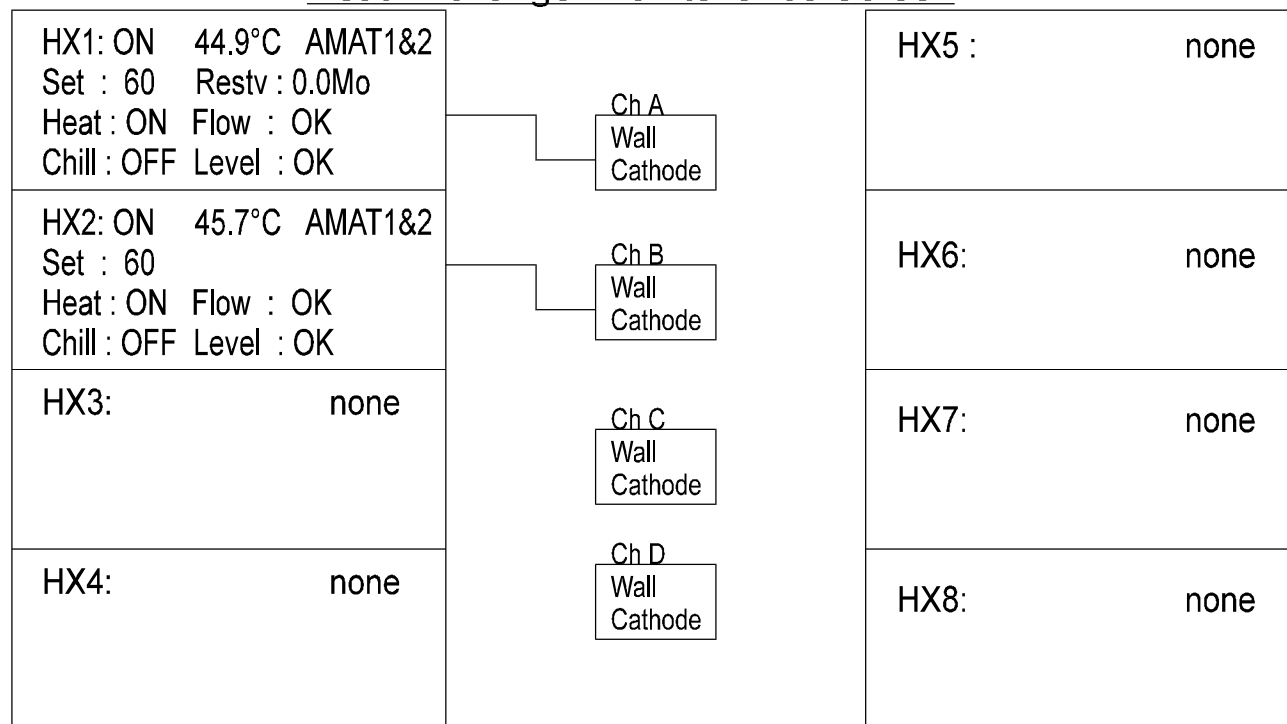

Previous Screen



Artisan Technology Group is your source for quality new and certified-used/pre-owned equipment

- FAST SHIPPING AND DELIVERY
- TENS OF THOUSANDS OF IN-STOCK ITEMS
- EQUIPMENT DEMOS
- HUNDREDS OF MANUFACTURERS SUPPORTED
- LEASING/MONTHLY RENTALS
- ITAR CERTIFIED SECURE ASSET SOLUTIONS

SERVICE CENTER REPAIRS

Experienced engineers and technicians on staff at our full-service, in-house repair center

*InstraView*SM REMOTE INSPECTION

Remotely inspect equipment before purchasing with our interactive website at www.instraview.com ↗

WE BUY USED EQUIPMENT

Sell your excess, underutilized, and idle used equipment. We also offer credit for buy-backs and trade-ins. www.artisanng.com/WeBuyEquipment ↗

LOOKING FOR MORE INFORMATION?

Visit us on the web at www.artisanng.com ↗ for more information on price quotations, drivers, technical specifications, manuals, and documentation

Contact us: (888) 88-SOURCE | sales@artisanng.com | www.artisanng.com