



Artisan Technology Group is your source for quality new and certified-used/pre-owned equipment

- FAST SHIPPING AND DELIVERY
- TENS OF THOUSANDS OF IN-STOCK ITEMS
- EQUIPMENT DEMOS
- HUNDREDS OF MANUFACTURERS SUPPORTED
- LEASING/MONTHLY RENTALS
- ITAR CERTIFIED SECURE ASSET SOLUTIONS

SERVICE CENTER REPAIRS

Experienced engineers and technicians on staff at our full-service, in-house repair center

*InstraView*SM REMOTE INSPECTION

Remotely inspect equipment before purchasing with our interactive website at www.instraview.com ↗

WE BUY USED EQUIPMENT

Sell your excess, underutilized, and idle used equipment. We also offer credit for buy-backs and trade-ins. www.artisanng.com/WeBuyEquipment ↗

LOOKING FOR MORE INFORMATION?

Visit us on the web at www.artisanng.com ↗ for more information on price quotations, drivers, technical specifications, manuals, and documentation

Contact us: (888) 88-SOURCE | sales@artisanng.com | www.artisanng.com

Electronic Rotary Cam Switch System
VARICAM®

VS-5E Series

SPECIFICATIONS & INSTRUCTION MANUAL



GENERAL SAFETY RULES



(Please read this safety guide carefully before operation)

Thank you very much for purchasing our product.
Before operating this product, be sure to carefully read this manual so that you may fully understand the product, safety instructions and precautions.

- Please submit this manual to the operators actually involved in operation.
- Please keep this manual in a handy place.



Signal Words

Safety precautions in this guide are classified into DANGER and CAUTION.

Symbol	Meaning
 DANGER	Incorrect handling may create a hazardous situation that will result in death or serious injury.
 CAUTION	Incorrect handling may create a hazardous situation that will result in moderate injury or physical damage.

Instructions accompanied by a  symbol may also result in serious damage or injury. Be sure to observe all instruction accompanied by symbol.





Graphic Symbols



Symbol	Meaning
	Indicates prohibited items.
	Indicates items that must be performed / adhered to.

Application Limitation



This product is not designated to be used under any situation affecting human life. When considering the use of this product for special purposes, such as for medical equipment, aerospace equipment, unclear power control systems, traffic systems, etc., please consult NSD.

1. Handling Precautions



 DANGER	
	- Do not touch components inside the controller. Doing so may result in electric shock.
	- Do not damage the cable by applying excessive load, placing heavy objects on it, or clamping it. Doing so may result in electric shock or fire.
	- Turn the power supply OFF before wiring, transporting and inspecting the controller. Failure to do so may result in electric shock. - Provide an external safety circuit so that the entire system functions safely even when the controller is faulty.
	- Connect the grounding terminal of the controller. Failure to do so may result in electric shock or malfunction.

 CAUTION	
	- Do not expose the controller to water, corrosive atmosphere, flammable gas, etc. Doing so may result in fire or the controller may become faulty.
	- Be sure to use the controller and the ABSOCODER sensor in the environment designated by the general specifications in the manual. Failure to do so may result in electric shock, fire, malfunction or unit failure. - Be sure to use the specified combination of the ABSOCODER sensor, controller and sensor cable. Failure to do so may result in fire or the controller may become faulty.



2. Storage

 CAUTION	
	- Do not store the controller in a place exposed to water, or toxic gas and liquid.
	- Be sure to store the controller in a place within the designated temperature and humidity range not exposed to direct sunlight. - Be sure to consult NSD when the controller is stored for long periods.



3. Transport



 CAUTION	
	- Do not hold the cable or shaft of ABSOCODER sensor when transporting. Doing so may result in injury or the controller may become faulty.

4. Installation



 CAUTION	
	- Do not step on the controller or place heavy objects on the controller. Doing so may result in injury. - Do not block the exhaust port or allow any foreign matter to enter the controller. Doing so may result in fire or unit failure.
	- Be sure to secure the controller and ABSOCODER sensor with the provided brackets. Failure to do so may allow these to fall, resulting in malfunction or injury. - Be sure to secure the specified distance between the main body and the control panel or other equipment. Failure to do so may result in malfunction.

5. Wiring



 DANGER	
	- Be sure to secure the terminal block firmly. Failure to do so may result in fire. - Be sure to mount the terminal cover provided with the controller before supplying power and starting operation after installation and wiring has been completed. Failure to do so may result in electric shock.

 CAUTION	
	- Be sure to keep the sensor cable, control cable, and communication cable at least 100 mm away from the main circuit and power line. Failure to do so may result in injury or in malfunction. - Be sure to connect all cables correctly. Failure to do so may result in injury or the controller may become faulty. - Be sure to firmly connect the external I/O connectors and sensor connectors. Failure to do so may result in incorrect input and output or injury.



6. Operation

 CAUTION	
	- Do not change the controller's function switch settings during operation. Doing so may result in injury. - Do not approach the machine after instantaneous power failure has been recovered. Doing so may result in injury if the machine starts abruptly.
	- Be sure to check that the power supply specifications are correct. Failure to do so may result in the controller becoming faulty. - Be sure to provide an external emergency stop circuit so that operation can be stopped with power supply terminated immediately. - Be sure to conduct independent trial runs for the controller before mounting the controller to the machine. Failure to do so may result in injury. - When an error occurs, be sure to eliminate the cause, ensure safety, and reset the error before restarting operation. Failure to do so may result in injury.

7. Maintenance And Inspection

 CAUTION	
	- Do not disassemble, remodel, or repair the unit. Doing so may result in electric shock, fire, or unit malfunction.
	- The capacitor of the power line deteriorates through prolonged use. We recommended that the capacitor be replaced every five years to prevent secondary damage.

8. Disposal

 CAUTION	
	- Be sure to handle the controller as industrial waste when disposing of it.

CONTENTS

A. Specifications Section

1. SUMMARY	A- 1
1-1. SUMMARY	A- 1
1-2. FEATURES	A- 2
1-3. SYSTEM COMPONENTS	A- 3
1-4. FUNCTIONS.....	A- 4
2. SPECIFICATIONS.....	A- 6
2-1. CONTROLLER SPECIFICATIONS	A- 6
2-1-1. <i>General Specifications</i>	A- 6
2-1-2. <i>Performance Specifications</i>	A- 6
2-1-3. <i>Input/Output Specifications</i>	A- 7
2-2. SENSOR SPECIFICATIONS	A- 8
2-3. EXTENSION CABLE SPECIFICATIONS	A- 8
3. OUTER DIMENSIONS	A- 9
3-1. CONTROLLER OUTER DIMENSIONS.....	A- 9
3-2. SENSOR OUTER DIMENSIONS.....	A-11
3-3. EXTENSION CABLE OUTER DIMENSIONS	A-14
3-4. EXTERNAL CABLE OUTER DIMENSIONS	A-14
4. MODEL LIST	A-15

B. Introductory Section

5. INSTALLATION	B- 1
5-1. CHECKING THE CONTENTS OF THE SHIPPING CASE	B- 1
5-2. MOUNTING PROCEDURE & PRECAUTIONS	B- 2
5-2-1. <i>Controller Mounting Procedure & Precautions</i>	B- 2
5-2-2. <i>Sensor Mounting Procedure & Precautions</i>	B- 3
6. WIRING & CONNECTIONS.....	B- 6
6-1. POWER SUPPLY CONNECTION.....	B- 6
6-2. CONTROLLER & SENSOR CONNECTION	B- 6

6-3. CONNECTOR CONNECTIONS	B- 7
6-3-1. Connector Names & Functions	B- 7
6-3-2. Signal Names & Descriptions	B- 7
6-3-3. Circuit Diagram	B- 8
6-3-4. Connector Pin Configuration & Signal Names	B- 8
6-3-5. Signal Timing	B-12

C. Operation Section

7. OPERATING SEQUENCE (FLOWCHART)	C- 1
--	-------------

8. OPERATION	C- 2
---------------------------	-------------

8-1. POWER ON	C- 2
8-2. SENSOR ROTATION DIRECTION SETTING	C- 3
8-3. ORIGIN POINT SETTING	C- 3
8-4. SWITCH OUTPUT SETTING	C- 4
8-5. RUN	C- 6

9. ADVANCED OPERATION	C- 7
------------------------------------	-------------

9-1. INITIAL SETTINGS	C- 7
9-1-1. Initial Setting List	C- 7
9-1-2. Basic Initial Setting Procedure	C- 9
9-1-3. Designation of VS-5EX Output Specifications (Designated for VS-5EX Model Only)	C-10
9-1-4. Protected Switch Function	C-11
9-1-5. Canceling the Protected Switch Function	C-12
9-1-6. Current Position Value Setting	C-13
9-2. DESIGNATING THE SWITCH OUTPUT SETTINGS	C-14
9-2-1. Setting The Switch Outputs by The TEACH Function	C-14
9-2-2. Designating Multi-Dog Settings	C-16
9-2-3. Canceling Multi-Dog Settings	C-17
9-2-4. Canceling Switch Output Settings	C-18
9-3. EXECUTING RUN	C-19
9-3-1. Checking Setting Values During Run	C-19
9-3-2. Changing The Setting Values During Run	C-20
9-3-3. Checking Switch Outputs From RUN Mode	C-21

10. ERRORS	C-22
-------------------------	-------------

10-1. ERROR DISPLAYS & COUNTERMEASURES	C-22
10-2. SETTING PROCEDURES AFTER REPLACING SENSOR/CONTROLLER	C-22

A. Specifications Section

1. Summary

1-1. Summary

Troublesome Cam Adjustments Made Easy By An Electronic Switch Format

A mechanical cam switch format using limit switches and cams has long been the standard in automatic machinery such as packing, printing, press, and assembly machines, and difficult angular adjustment and switch replacement procedures have long been the cause of headaches.

Now, with the VS-5E Series, this mechanical switch format has been replaced with an easy electronic cam switch format. With our durable Absocoder sensor mounted on the rotational axis, the switch ON/OFF positions can be easily designated from the Controller to obtain cam outputs which correspond to the rotational angle.

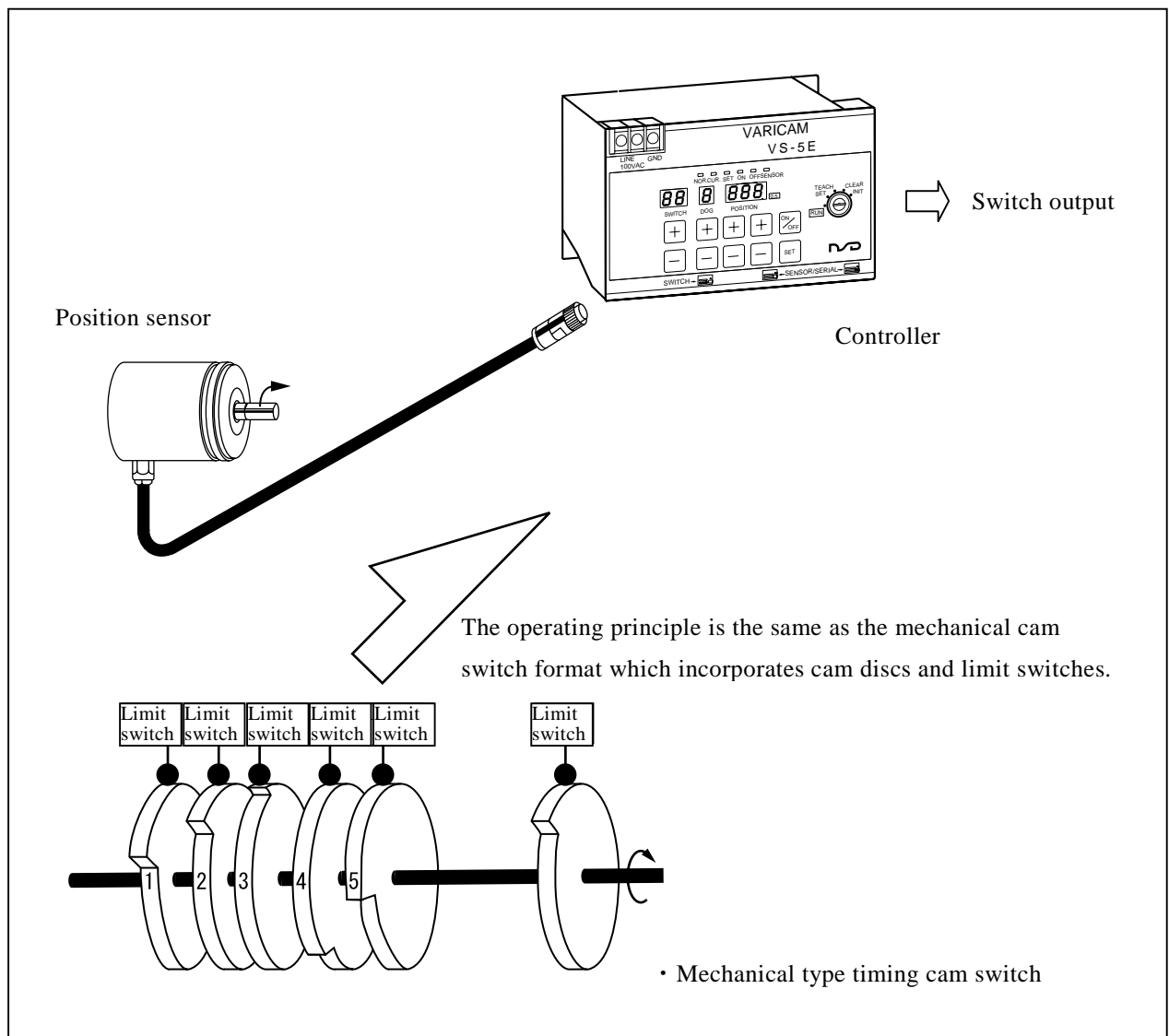

1-2. Features

(1) Easy Setting Procedure With No Cam Adjustments

ON/OFF-position settings are designated by a simple key input operation. Settings can also be designated using the TEACH function.

(2) Compact Design And Minimal Wiring

With only a compact Sensor mounted on the machine, minimal space is required. The Sensor and Controller are connected by a single cable, making connection quick and easy.

(3) Durable Absocoder Sensor

NSD's unique Absocoder Position Sensor is designed to withstand vibration, shocks, severe temperatures, oil, and dust, etc., making it ideal for factory environments.

(4) No Origin-Point Return Required When Power is Interrupted

An absolute angle detection format eliminates cumulative error, and does away with the need for origin-point returns when the power supply is interrupted.

(5) Automated Setup Changes

With the VS-5ED and VS-5EX Models, several Programs can be registered in advance. When a setup change occurs, simply select the appropriate Program.

(6) Accommodates High-Speed Machine Operation

With a switch ON/OFF width of 1 degree, response is possible for speeds as high as 900 rpm, enabling faster machine speeds.

(7) Three Sensor Size Available (28, 62)

The appropriate sized sensor for your specific needs can be selected. (28 small size, 62 standard size.)

(8) 100 Meter Cable Extension

The standard 2-meter sensor cable can be extended to 100 meters using the special extension cable.

1-3. System Components

6 Controller types, and 2 Sensor types are available.

Select the appropriate type according to the application and environment.

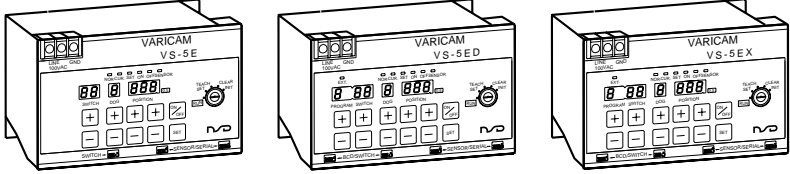
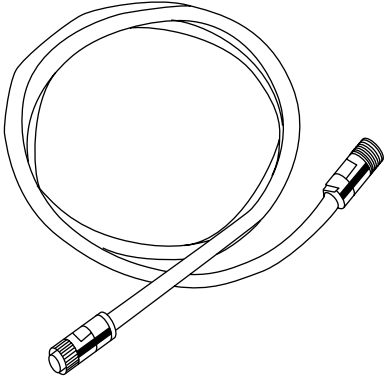
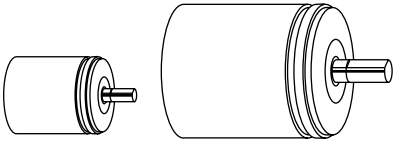
<p>Controllers</p>	<p style="text-align: center;">VS-5E,VS-5E-1 VS-5ED,VS-5ED-1 VS-5EX,VS-5EX-1</p> 
<p>Extension Cables</p>	<p style="text-align: center;">3P-S-0102(FG)-L 3P-RBT-0102(FG)-L</p> 
<p>Sensors</p>	<p style="text-align: center;">VRE-P028 VRE-P062</p>  <p style="text-align: center;">28 62</p>

1-4. Functions

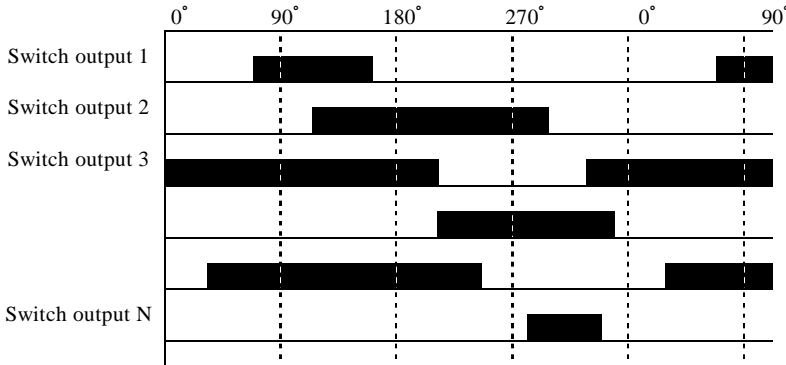
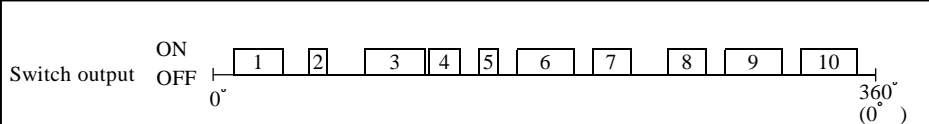
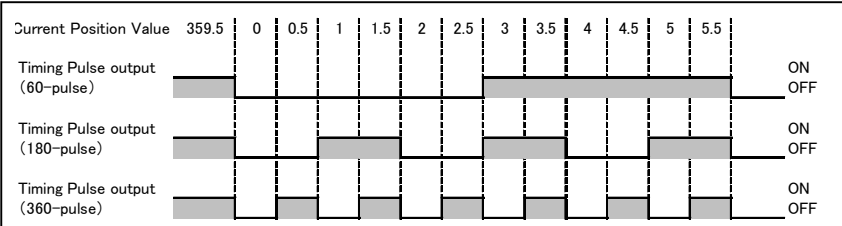
Function	Description																		
<p>Switch Output Function</p>	<p>The operating principle is the same as the mechanical cam disk and limit switch format. ON/OFF settings are designated at the Controller, and switch output ON/OFF operations occur according to the rotation angle of the Sensor.</p> <p>< Ex > ON Angle OFF Angle</p> <table border="1" data-bbox="518 376 901 555"> <tr> <td>Switch output 1</td> <td>75°</td> <td>165°</td> </tr> <tr> <td>Switch output 2</td> <td>120°</td> <td>300°</td> </tr> <tr> <td>Switch output 3</td> <td>320°</td> <td>210°</td> </tr> <tr> <td>:</td> <td>210°</td> <td>350°</td> </tr> <tr> <td>:</td> <td>30°</td> <td>250°</td> </tr> <tr> <td>Switch output N</td> <td>280°</td> <td>340°</td> </tr> </table> 	Switch output 1	75°	165°	Switch output 2	120°	300°	Switch output 3	320°	210°	:	210°	350°	:	30°	250°	Switch output N	280°	340°
Switch output 1	75°	165°																	
Switch output 2	120°	300°																	
Switch output 3	320°	210°																	
:	210°	350°																	
:	30°	250°																	
Switch output N	280°	340°																	
<p>Multi-Dog Function</p>	<p>Up to 10 ON/OFF values (dogs) can be designated for each switch.</p> 																		
<p>Protected Switch Function</p>	<p>The primary feature of the Varicam system is that it enables switch output settings to be changed quickly and easily. However, there are certain switch outputs where an easy setting change is not desirable. The “Protected Switch” function is used in such cases to prevent the setting from being changed in the usual manner. To change or delete a protected switch, the Protected Switch function must first be canceled. The Protected Switch function can be used for switch Nos. 1-10.</p>																		
<p>Timing Pulse Output</p>	<p>This output, which consists of ON/OFF signal outputs evenly spaced through 1 revolution, is convenient for detecting the rotation speed. 60, 180, or 360(per revolution) timing pulse types can be selected.</p> <p>Current Position Value & Pulse Output</p> 																		

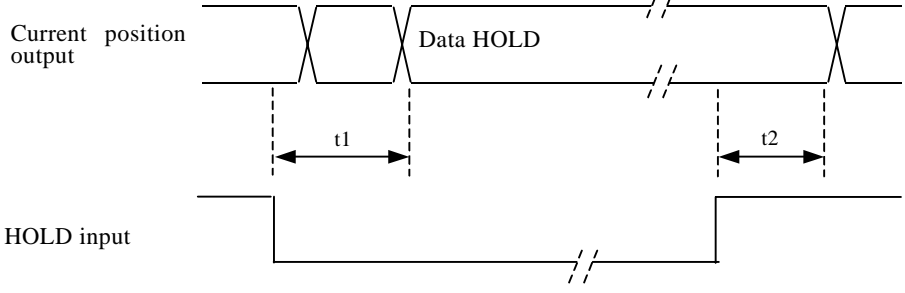
Function	Description
External Origin Set Function	Origin-point (zero-point) setting is executed by an external signal input. (Standard VS-5EX function)
TEACH Setting	Switch ON/OFF positions are designated by actually moving the machine to those positions.
Current Position HOLD Function	<p>When the Programmable Controller reads the current position output, the current position value changes faster than the Controller can scan the data, making a correct reading impossible. To counter this problem, the HOLD function prevents the current position value from changing when Controller reading occurs.</p> <p>(Standard VS-5ED and VS-5EX function)</p> 
Output HOLD Function	When the mode selector switch setting is changed from RUN to another mode position, the output status which existed in the RUN mode will be maintained.
Serial Communication Function	An RS-232C connector is provided for copying the switch output settings to the Host Controller as a backup measure. For details regarding serial communication procedures, contact your NSD representative.

2. Specifications

2-1. Controller Specifications

2-1-1. General Specifications

Item	Specifications		
Model	VS-5E, VS-5ED, VS-5EX	VS-5E-1, VS-5ED-1, VS-5EX-1	
Construction	Built-in type (mounting on panel face is also possible using a special fixture)		
Input power voltage	100VAC 50/60Hz	24VDC	
Permissible voltage fluctuation	85V - 132VAC	21.6V - 30VDC	
Power consumption	20VA or less	8VA or less	
Insulation resistance	20M or more between AC power terminals & ground		
Withstand voltage	1500VAC, 60Hz, for 1 minute between AC power terminals and ground	500VAC, 60Hz, for 1 minute between DC power terminals and ground	
Ambient temperature	0 - 55		
Ambient humidity	20 - 90%RH (no condensation)		
Ambient atmosphere	Free of corrosive gases, excessive dust, etc.		
Ground	Must be securely grounded		
Weight	Approx. 0.7kg		

Note: The VS-5E-1, VS-5ED-1, and VS-5EX-1 operation panel inscriptions appear in both in English and Japanese.

2-1-2. Performance Specifications

Item	Specifications			
Model	VS-5E, VS-5E-1	VS-5ED, VS-5ED-1	VS-5EX, VS-5EX-1	
Position detection format	Absolute detection			
Number of position detection devices	1			
ON/OFF position setting format	Numeric key input or TEACH setting			
Minimum setting unit	0.5°			
Number of multi-dogs	Max. of 10 per switch output			
Response rotation speed	Max. 900 rpm (when ON/OFF zone is 1 degree)			
Number of Programs	1	8	16	32
Number of switch outputs	24	24	40	24
Setting value memory	EEP-ROM			
Display	Switch No., multi-dog No., current position value, setting value, operation error, initial No. Program No.			
Error displays	Memory error, sensor error, no setting, setting impossible			
Auxiliary functions	-Protected switch (for switch No.1-10 outputs) -Timing pulse output (60, 180, 360 pulse/revolution) -Setting change during operation			
	-Serial communication		External origin set function Current position output	

2-1-3. Input/Output Specifications

Item	Specifications			
Model	VS-5E, VS-5E-1	VS-5ED, VS-5ED-1	VS-5EX, VS-5EX-1	
Input signals		-Program No...3 points -HOLD...1 point	-Program No...4 points -HOLD or External Origin Set...1 point	-Program No...5 points -HOLD or External Origin Set...1 point
Output signals	-Switch output...24 points -Timing pulse...1 point -System Ready...1 point	-Switch output...24 points -Timing pulse...1 point -System Ready...1 point -Program No...3 points -Current pos. value (BCD)...3-digit + 0.5 display -Latch pulse...1 point	-Switch output...40 points -Timing pulse...1 point -System Ready...1 point -Program No...4 points -Current pos. value (BCD)...3-digit + 0.5 display -Latch pulse...1 point	-Switch output...24 points -Timing pulse...1 point -System Ready...1 point -Program No...5 points -Current pos. value (BCD)...3-digit + 0.5 display -Latch pulse...1 point

Item		Specifications		Circuit Diagram
Input	Program No. HOLD input	Input format	DC input, negative logic	
		Rated input voltage	24VDC	
		Input current	10mA TYP (24VDC)	
		Isolation	Photo-coupler	
Output	Switch output Program No.	Output format	Transistor open collector, negative logic	
		Rated load voltage	24VDC (Max. 30V)	
		Max. load current	100mA	
		Max. voltage drop when ON	2.0V (100mA)	
		Isolation	Photo-coupler	
	Timing pulse	Output format	Transistor open collector, negative logic	
		Rated load voltage	24VDC (Max. 30V)	
		Max. load current	100mA	
		Max. voltage drop when ON	1.5V (100mA)	
		Isolation	Photo-coupler	
Current position value BCD output latch pulse	Output format	Transistor open collector, positive logic		
	Rated load voltage	24VDC (Max. 30V)		
	Max. load current	5mA		
	Max. voltage drop when ON	0.7V (5mA)		
	Isolation	Photo-coupler		

2-2. Sensor Specifications

Model Code		VRE-P062		VRE-P028	
Outside Dimensions	mm	62 dia. x 71.5 long		28 dia. x 35 long	
Mass	kg	1.2		0.25	
Starting Torque	N-m	4.9 x 10 ⁻² or less (with oil seal)		1.5 x 10 ⁻³ or less (without oil seal)	
Moment Inertia	kg-m ²	6.4 x 10 ⁻⁶		9.3 x 10 ⁻⁸	
Permissible Input Shaft Load	Radial	N	98	15	
	Thrust	N	49	9.8	
Mechanical permissible Input Shaft Speed	r/min	3,600		6,000	
Resistance to Vibration		20G, 2,000 Hz, up/down 4h, forward/back 2h, conforms to JIS D1601 standard			
Cable Length	standard	2m			
	option	Extensible up to 100 m			
Ambient Temperatures	Storage	-30 to +90			
	Operating	-20 to +60			

2-3. Extension Cable Specifications

Cable Type	STANDARD	ROBOTIC
Model Code	3P-S-0102-[]	3P-RBT-0102-[]
	Specify an overall length of cable required in []	
Ambient Operating Temperature Range	-5 to +60	
Construction	3-pair (6-core)	
Cross-sectional Area of Wire	0.2mm ²	
Color of Sheath	Grey	Black
Advantages	Standard cable	Usable with moving machine member thanks to excellent flexibility.
Available Length of Cable Assembly	2, 3, 5, 8, 10, 13, 15, 20, 30, 50, 100 meters	2, 3, 5, 8, 10, 13, 15, 20, 30, 50, 100 meters
	6.5, 9.8, 16.4, 26.2, 32.8, 42.6, 49.2, 65, 98, 164, 328 ft.	6.5, 9.8, 16.4, 26.2, 32.8, 42.6, 49.2, 65, 98, 164, 328 ft.

3. Outer Dimensions

3-1. Controller Outer Dimensions

VS-5E (VS-5E-1 model has same dimensions.)

Unit: mm

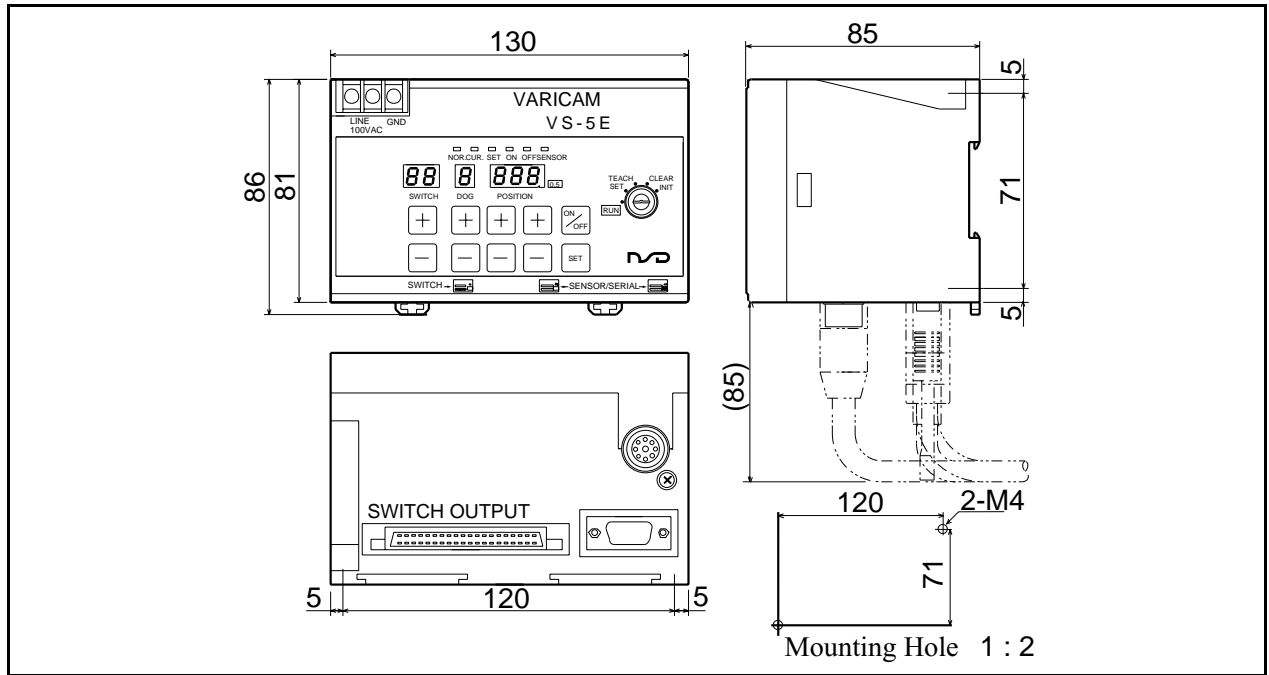

VS-5ED (VS-5ED-1 model has same dimensions.)

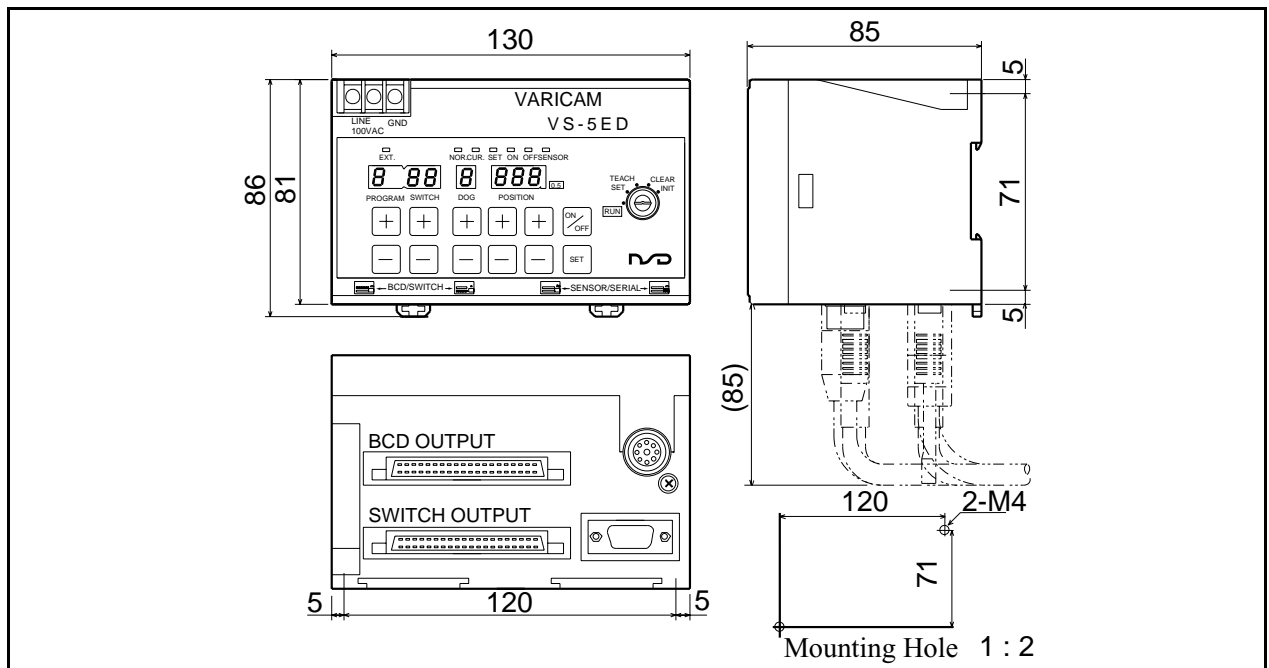

Note: The VS-5E-1, VS-5ED-1, and VS-5EX-1 operation panel inscriptions appear in both in English and Japanese.

VS--5EX (VS-5EX-1 model has same dimensions.)

Unit: mm

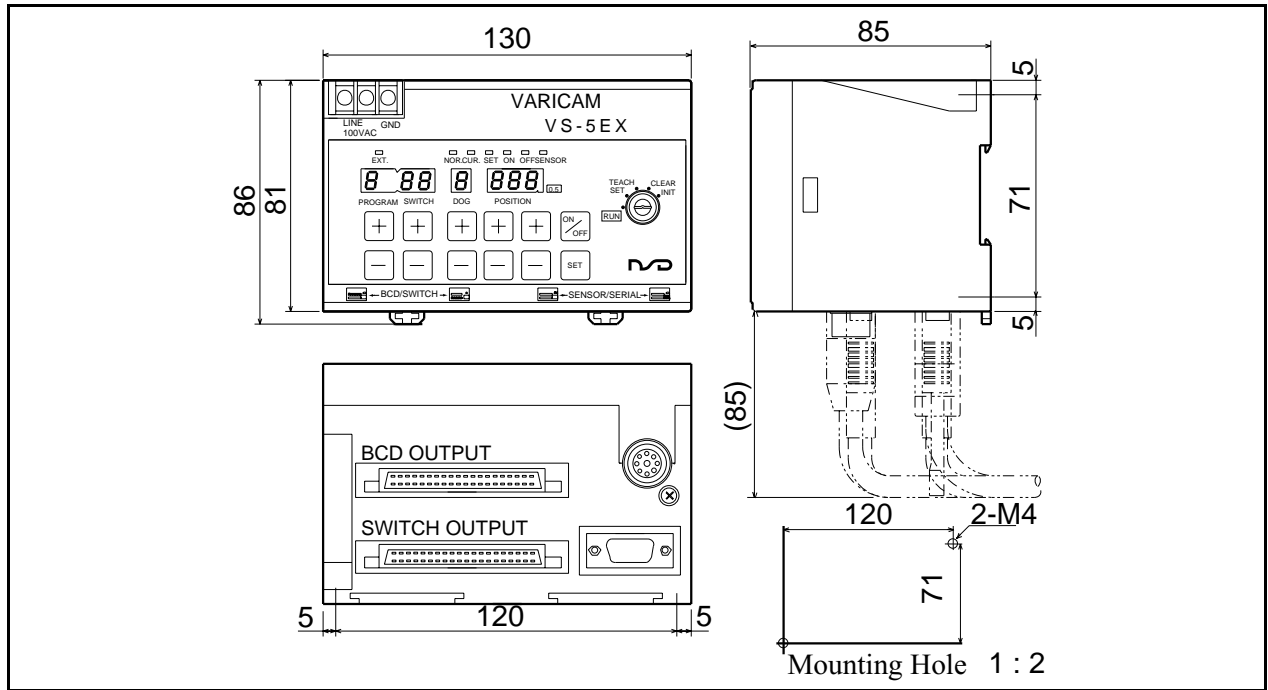

Outer Dimensions when panel mounting fixture (VS-K05) is used.

The VS-K05 can be used for 6 Controller types.

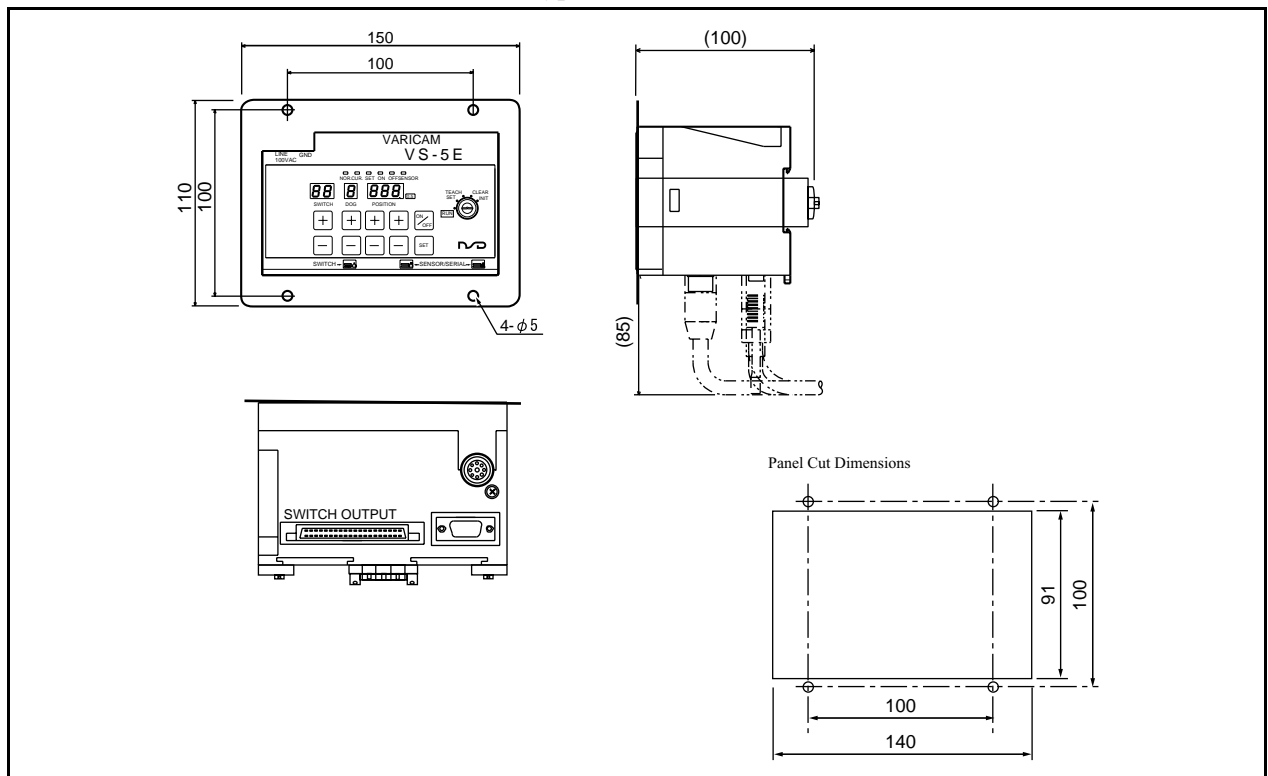

3-2. Sensor Outer Dimensions

VRE-P062SAC

Unit: mm

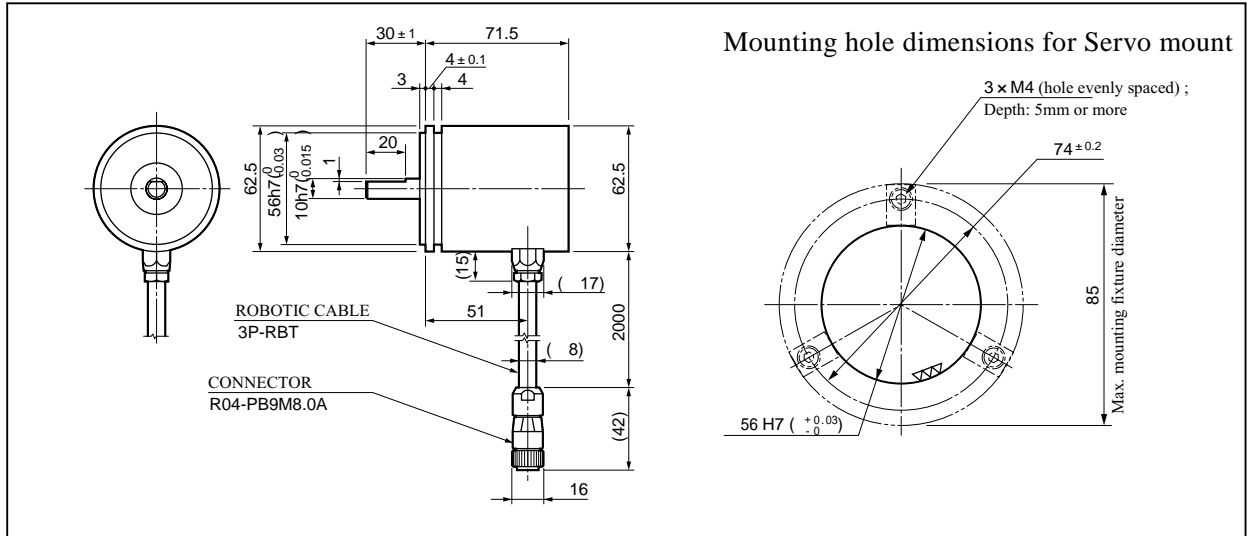

VRE-P062SBC

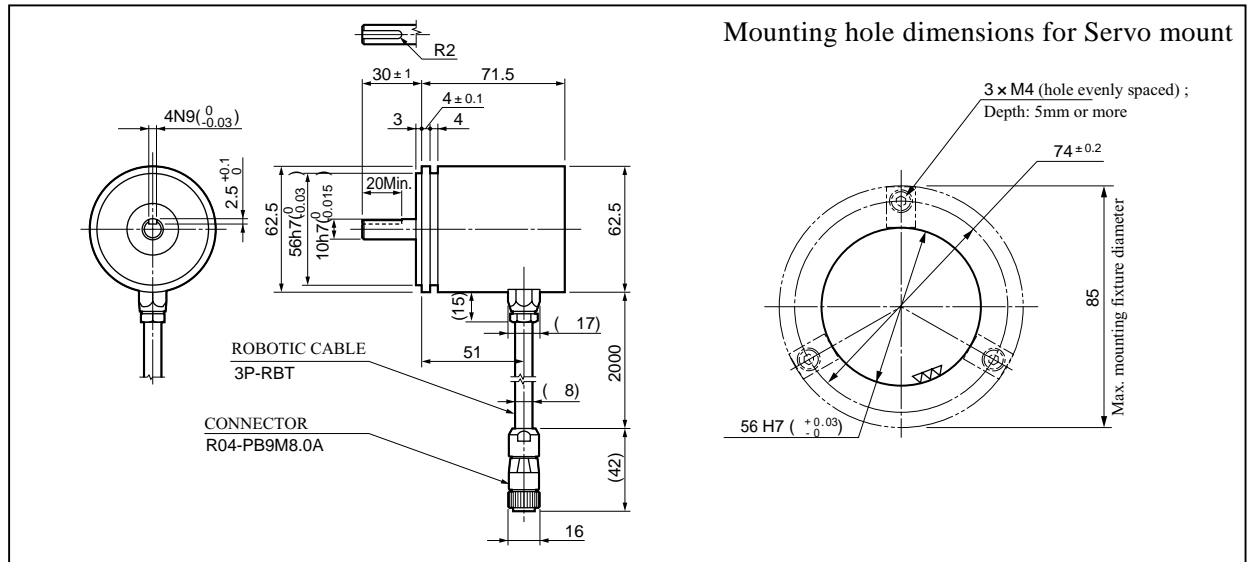

Mounting fixture for reinforced
Servo mount (2 piece set)

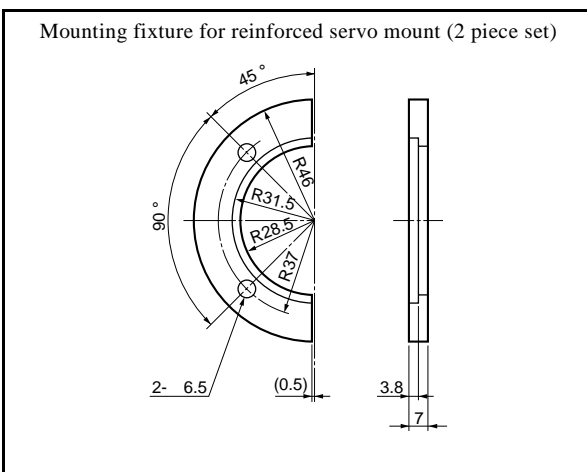

Mounting hole dimensions for
VRE-P062SAC/SBC reinforced Servo mount

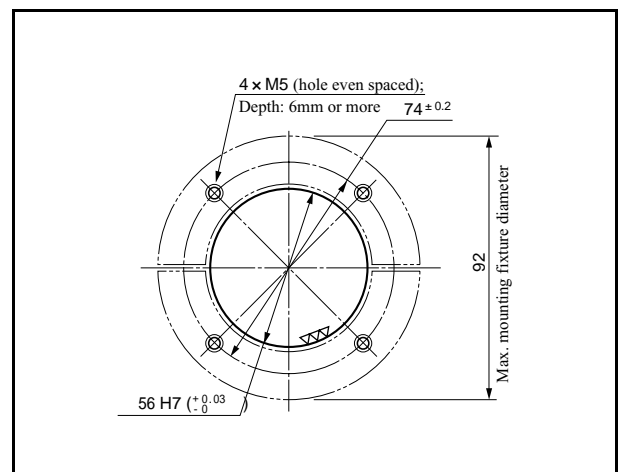

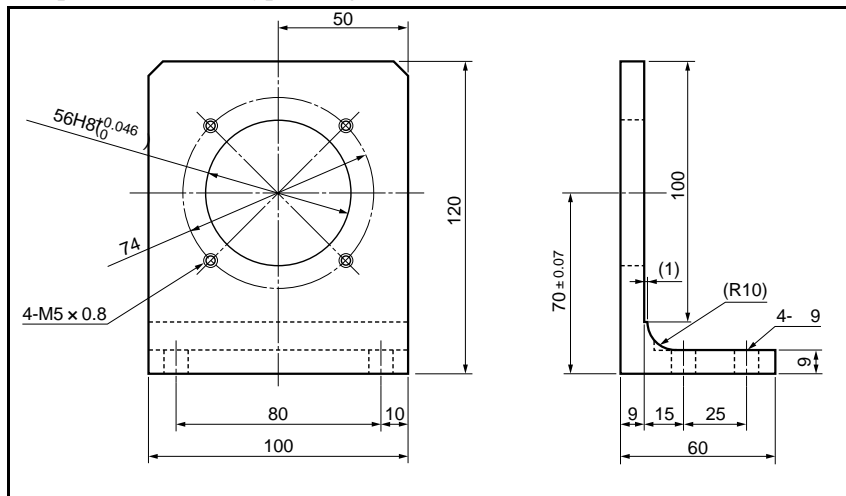
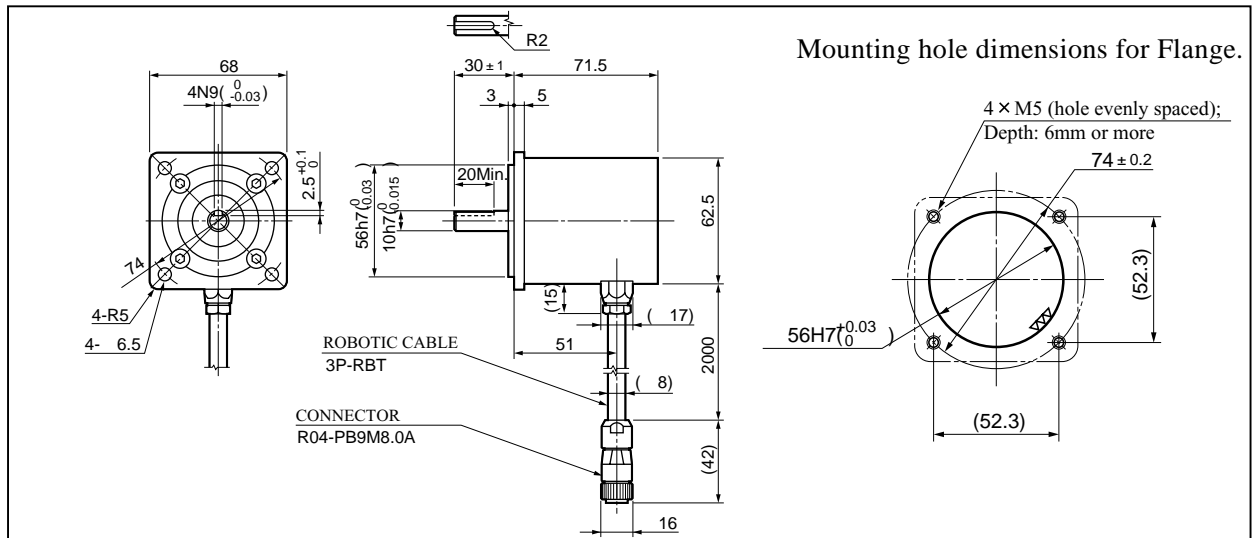
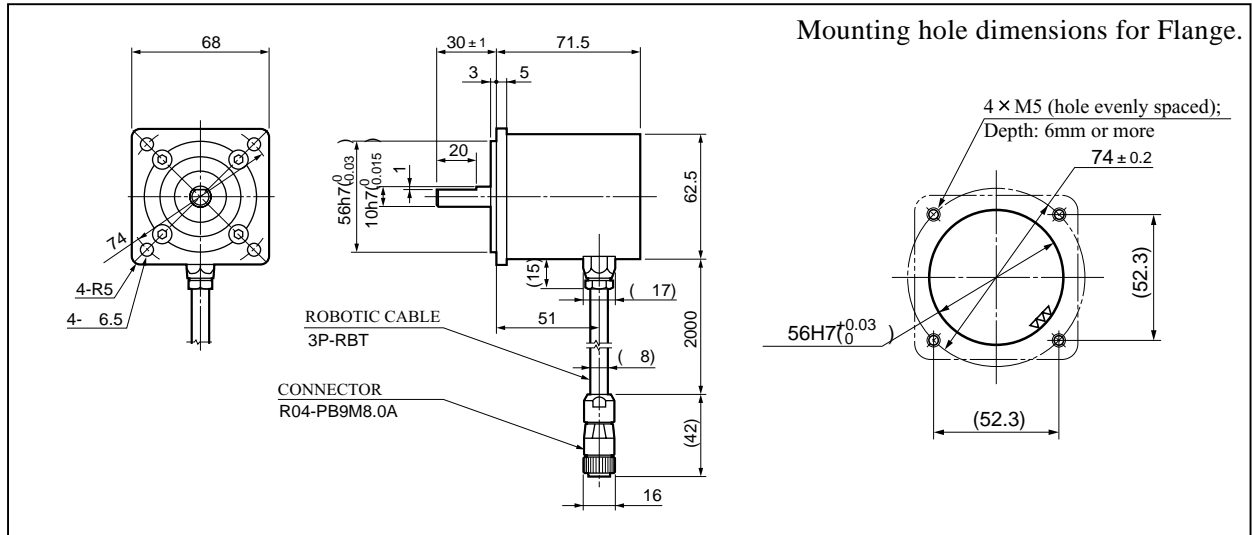

Used for flange type and reinforced servo type mounts.

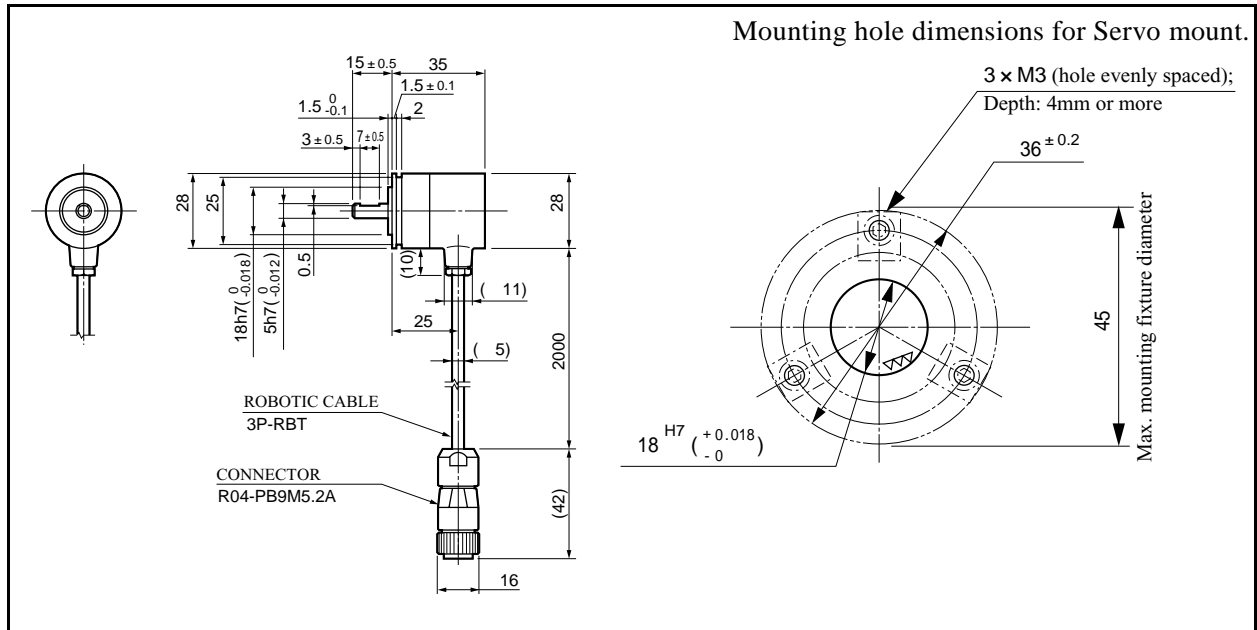

3-3. Extension Cable Outer Dimensions

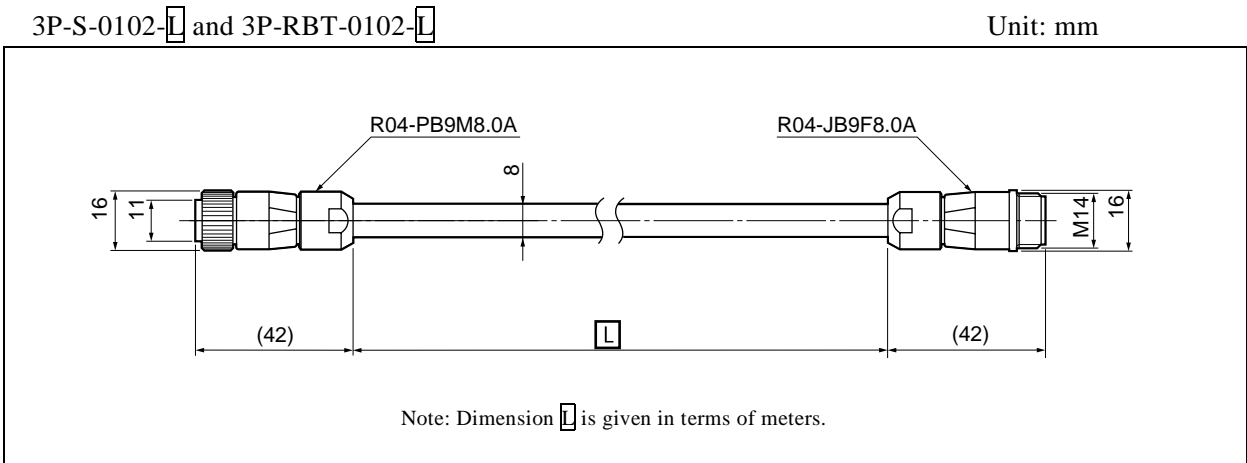

3-4. External Cable Outer Dimensions

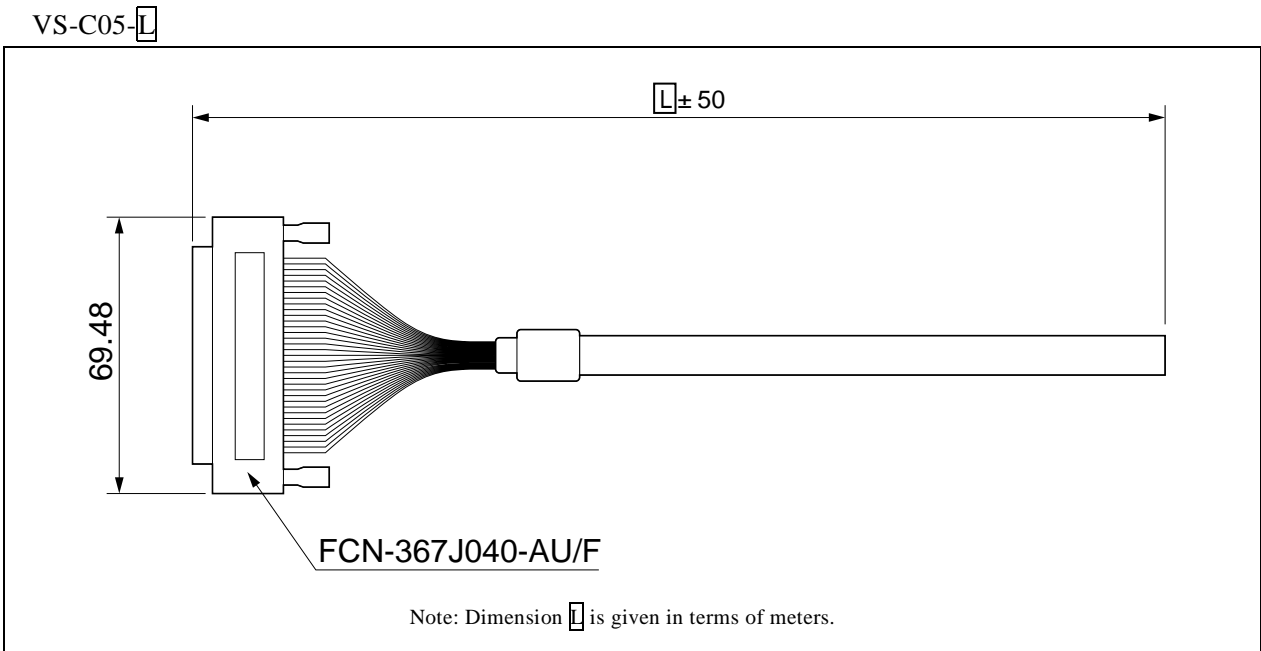

4. Model List

Select the appropriate Model from the Table below.

Name	Model	Description	
Controller	VS-5E	1 Program, 24-point output, Power voltage 100VAC	
	VS-5ED	8 Programs, 24-point output, Power voltage 100VAC	
	VS-5EX	16 Programs, 40 point output; or 32 Programs, 24-point output, Power voltage 100VAC	
	VS-5E-1	1 Program, 24-point output, Power voltage 24VDC	
	VS-5ED-1	8 Program, 24-point output, Power voltage 24VDC	
	VS-5EX-1	16 Programs, 40-point output; or 32 Programs, 24-point output, Power voltage 24VDC	
Sensor	VRE-P062SAC	Outer shape: 62 dia. shaft type: Notched, with servo mounting fixture (*1).	
	VRE-P062SBC	Outer shape: 62 dia. shaft type: Keyway, with servo mounting fixture (*1).	
	VRE-P062FAC	Outer shape: 62 dia. shaft type: Notched, with flange mounting format.	
	VRE-P062FBC	Outer shape: 62 dia. shaft type: Keyway, with flange mounting format.	
	VRE-P028SAC	Outer shape: 28 dia. shaft type: Notched, with servo mounting fixture.	
Extension cable	3P-S-0102-2	Standard cable 2m	
	3P-S-0102-3	3m	
	3P-S-0102-5	5m	
	3P-S-0102-8	8m	
	3P-S-0102-10	10m	
	3P-S-0102-15	15m	
	3P-S-0102-20	20m	
	3P-S-0102-30	30m	
	3P-S-0102-50	50m	
	3P-S-0102-100	100m	
	3P-RBT-0102-3	Robotic cable 3m	
	3P-RBT-0102-5	5m	
	3P-RBT-0102-10	10m	
	3P-RBT-0102-15	15m	
	3P-RBT-0102-20	20m	
	3P-RBT-0102-30	30m	
	3P-RBT-0102-50	50m	
	Panel-mount fixture	VS-K05	
	Reinforced servo mounting fixture	SH-01	Can be used with the VRE-P062SAC and VRE-P062SBC.
	L-Shaped flange	RB-01	Can be used with the VRE-P062.
External cable	VS-C05-1	1m	
	VS-C05-2	2m	

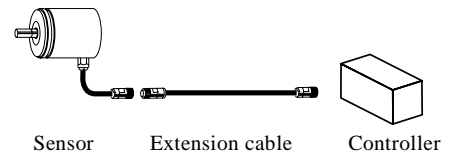

*1. The sensor's servo mounting fixture is normally secured at 3 points. However for the 62 dia. type, a reinforced fixture which is secured at 4 points is also available. (Specify when ordering.)

*2. Designate the desired cable length (in meters) at the [L] box portion of the model name.

B. Introductory Section

5. Installation

The handling procedures from the point of delivery to system installation are described in this section.

5-1. Checking The Contents of The Shipping Case

Open the packing case, and verify that all items are present.

(1) Controller

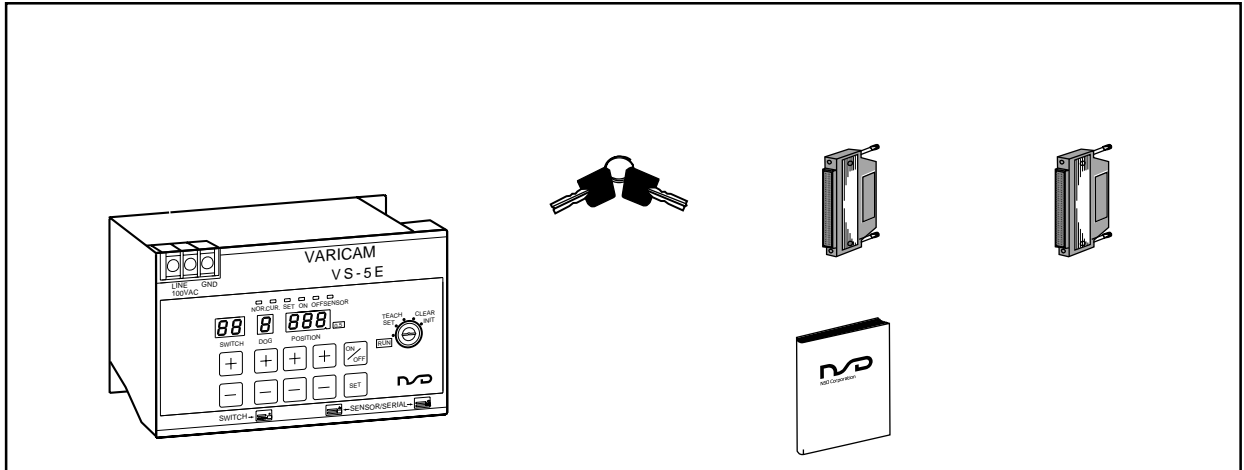

[1] Controller unit	1 unit	[4] BCD connector	1 unit
		(not provided with VS-5E Model)	
[2] Keys	2 keys	[5] Operation Manual	
[3] Switch output connector	1 unit		

(2) Sensor

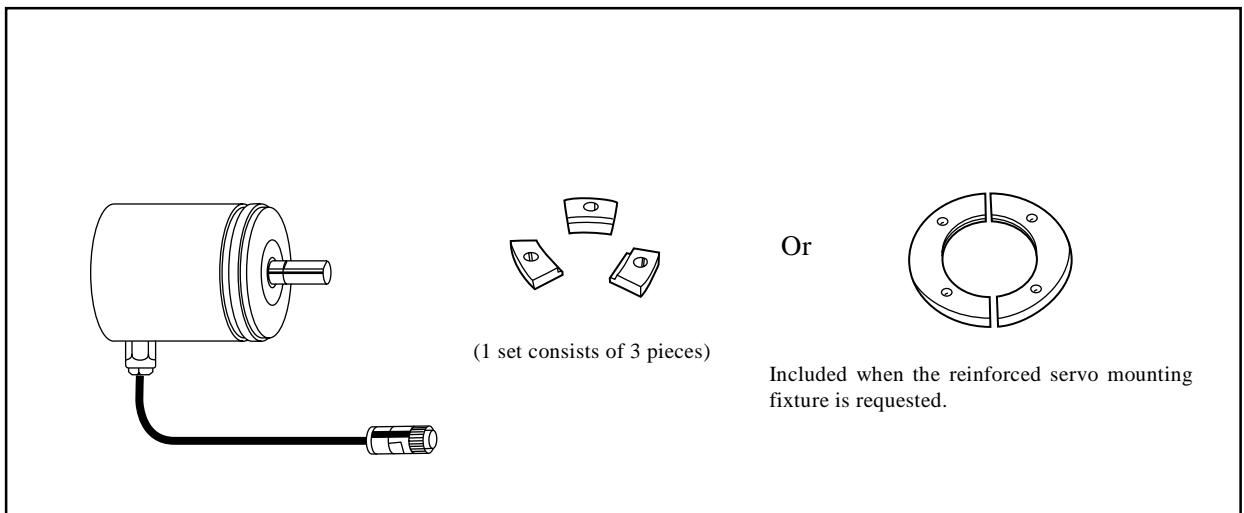

[1] Sensor unit	1 unit	[3] Reinforced servo mounting fixture	1 unit
[2] Servo mounting fixture	1 set		(Option)

Notes:

1. When an extension cable and/or the panel-mounting fixture has been ordered, these will be shipped in a separate case.
2. Auxiliary items are not included for the flange mount type sensor.

5-2. Mounting Procedure & Precautions

The Controller and Sensor installation procedure and precautions are described in this section. Refer to item 3 (Outer Dimensions) at the Specifications Section for further mounting information.

5-2-1. Controller Mounting Procedure & Precautions

When installing the Controller, the following conditions and precautions should be observed.

Installation Site

The following conditions should be satisfied:

1) The Controller should not be exposed to direct sunlight.
2) The ambient temperature should be kept within a 0-55 °C range.
3) The ambient humidity should be kept within a 20-90% RH range.
4) Avoid areas where condensation is likely (high humidity areas with extreme temperature changes).
5) Avoid areas where dust is excessive.
6) Avoid areas containing high levels of salt or rust.
7) The site should be free of flammable and corrosive gases.
8) The site should be away from splashing water, oil, or chemicals.
9) Avoid areas where vibration and shocks are excessive.

Installation Precautions

1) Either secure the unit with 2 M4 screws, or secure it to a DIN rail. (Recommended DIN rail: PFP100N (2) (Omron Co.))
2) In order to improve noise resistance, install as far away as possible from high-voltage and power cables.
3) A space of approximately 85mm is required beneath the Controller to plug in and unplug the connectors.

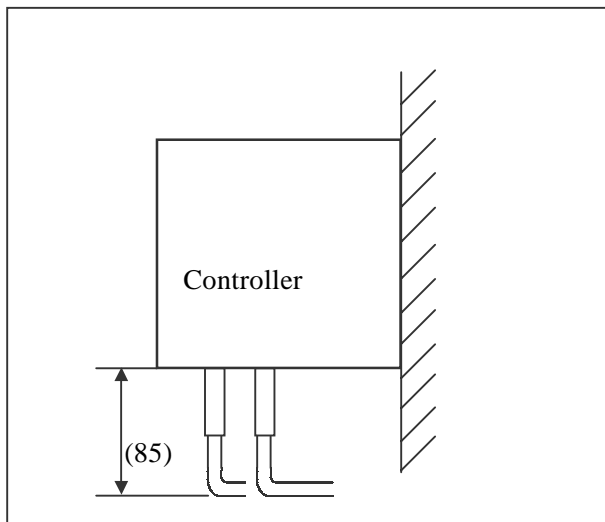

5-2-2. Sensor Mounting Procedure & Precautions

Sensor Handling

Item	Description
Never drop the Sensor, or subject it to excessive forces or shocks.	
Avoid stepping on, or applying excessive stress to the cable.	

Sensor Body

Item	Description	Remarks
(1) Mounting dimensions	Refer to the outline drawing for the Sensor model in question to determine the mounting dimensions.	
(2) Cable port	When possible, the cable port should be facing downward. 	
(3) Cable	The bend diameter for movable parts should never be less than 150mm (robot cable). 	Do not use the standard cable for movable parts.

Sensor Shaft Mounting Procedure

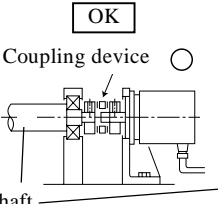
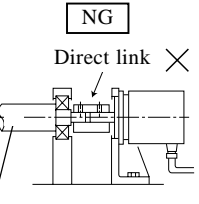
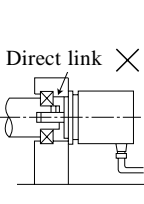
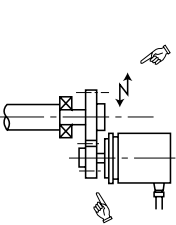
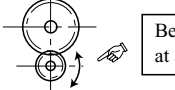
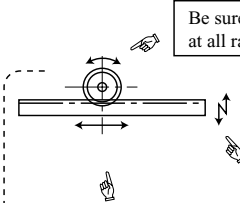
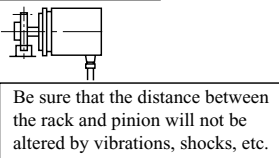
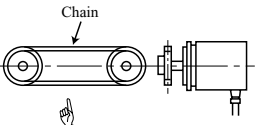
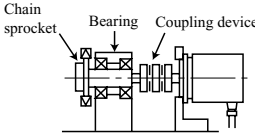
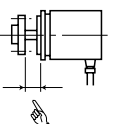
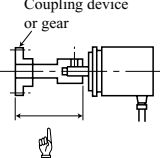
Item	Description	Remarks
(1) Coupling of Machine shaft and Sensor shaft	<p>Be sure to use a coupling device to link the 2 shafts. (Refer to Appended Fig.1 for the recommended coupling device specifications.)</p> <div style="display: flex; justify-content: space-around; align-items: center;"> <div style="text-align: center;"> <p>OK</p>  </div> <div style="text-align: center;"> <p>NG</p>  </div> <div style="text-align: center;"> <p>NG</p>  </div> </div> <p style="text-align: center;">Shaft</p>	<p>A `direct-link` format will result in shaft fatigue and/or breakage after a long periods. Therefore, be sure to use a coupling device to link the shafts.</p>
(2) For gear-type linkage	<p>If a gear linkage is used, be sure that some backlash exists.</p> <div style="display: flex; justify-content: space-around; align-items: center;"> <div style="text-align: center;"> <p>Be sure that the distance between shafts will not be altered by vibrations, shocks, etc.</p>  </div> <div style="text-align: center;"> <p>Be sure that backlash exists at all gear positions.</p>  </div> </div> <p style="text-align: center;">The Sensor shaft pinion should be as light (small) as possible. This is especially true for environments where vibration/shocks are likely.</p>	<p>Incorrect gear mounting can result in gear bending or breakage.</p>
(3) For rack-and-pinion type linkage	<p>Be sure that backlash exists at all rack positions.</p> <div style="display: flex; justify-content: space-around; align-items: center;"> <div style="text-align: center;"> <p>Be sure that backlash exists at all rack positions.</p>  </div> <div style="text-align: center;"> <p>Be sure that the distance between the rack and pinion will not be altered by vibrations, shocks, etc.</p>  </div> </div> <p style="text-align: center;">Be sure that the distance between the rack and pinion is not altered when horizontal motion of the rack occurs.</p> <p style="text-align: center;">The Sensor shaft pinion should be as light (small) as possible. This is especially true for environments where vibration/shocks are likely.</p>	<p>Incorrect rack-and-pinion mounting can result in gear bending or breakage.</p>
(4) For chain or pulley linkage	<p>When a chain or pulley linkage format is used, there is an inherent risk of the shaft's load being increased by the resulting tension. Therefore, a bearing should be used, with the shafts being linked by a coupling device immediately behind the bearing.</p> <p style="text-align: center;">Recommended linkage format :</p> <div style="display: flex; justify-content: space-around; align-items: center;"> <div style="text-align: center;"> <p>Chain</p>  </div> <div style="text-align: center;"> <p>Chain sprocket Bearing Coupling device</p>  </div> </div> <p style="text-align: center;">Even a small amount of tension can produce a considerable load on the shaft.</p> <p style="text-align: center;">This linkage format is also applicable to the `rack-and-pinion` and `gear` methods shown above.</p>	
(5) Shaft mounting position	<p>The shaft should be attached to the coupling device or gear at a point which is as near to the Sensor body as possible.</p> <div style="display: flex; justify-content: space-around; align-items: center;"> <div style="text-align: center;"> <p>NG</p>  </div> <div style="text-align: center;"> <p>NG</p>  </div> </div> <p style="text-align: center;">This distance should be as short as possible. ○ When this distance is short, the load placed on the bearing by vibrations/shocks is slight.</p> <p style="text-align: center;">Never use an extended shaft format.</p>	

Coupling Device Selection and Handling

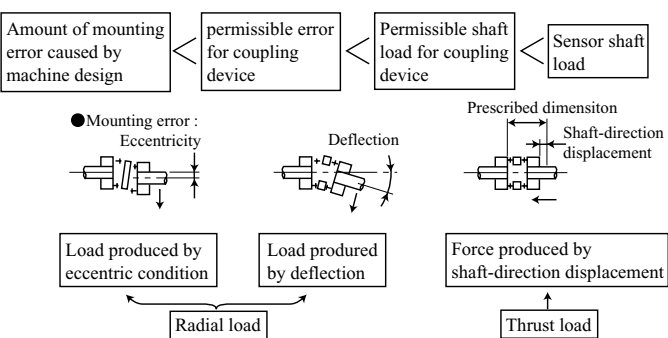
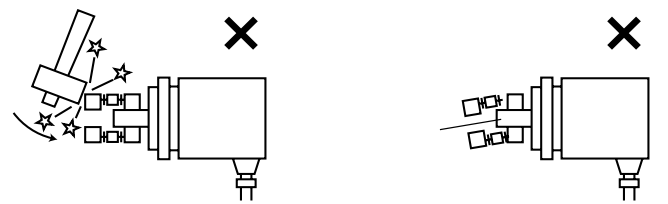
Item	Description	Remarks
<p>(1) Coupling device selection precautions</p>	<p>Selection of the coupling device should be based on the following factors:</p>  <p>● Mounting error : Eccentricity</p> <p>Deflection</p> <p>Prescribed dimension Shaft-direction displacement</p> <p>Load produced by eccentric condition</p> <p>Load produced by deflection</p> <p>Force produced by shaft-direction displacement</p> <p>Radial load</p> <p>Thrust load</p> <p>If the selected coupling device is larger than necessary (when used in high vibration/shock environments), the load which is applied to the shaft by the vibrations/shocks will be increased by the weight of the coupling device. Be sure to select a coupling device with an adequate transmission torque surplus relative to the Sensor shaft's torque.</p>	<p>A larger than necessary coupling device will increase the 'mounting error' shaft load accordingly.</p>
<p>(2) Coupling device installation precautions</p>	<p>Never hammer the coupling device into position, and be sure that it is mounted in a straight manner.</p> 	<p>Excessive force may deform the coupling device, thereby reducing its efficiency and durability.</p>

6. Wiring & Connections

6-1. Power Supply Connection

(1) Power Supply

- The power cable should be as thick as possible to minimize voltage drops.
- Twist the power cable.
- For crimp type terminals, use the R3 type.

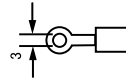

(2) Ground

- Be sure the unit is securely grounded in order to prevent electrical shocks.
- The cable should be as thick as possible.

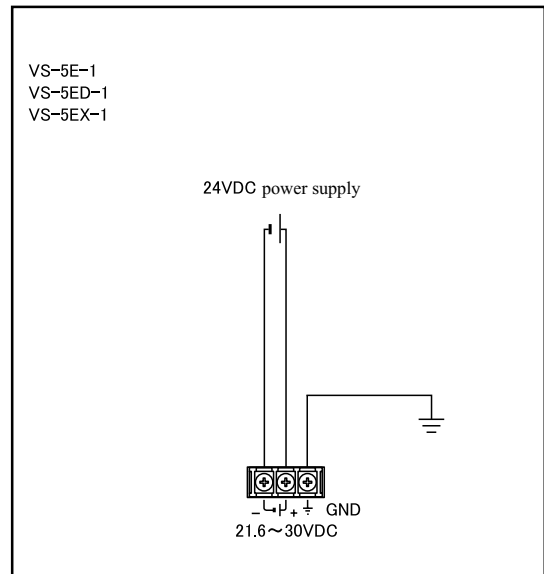
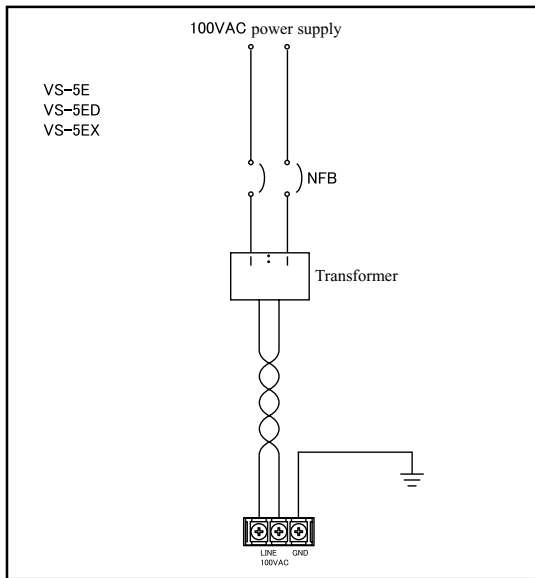

6-2. Controller & Sensor Connection

The Sensor is equipped with a 2-meter cable. If a longer cable length is required, the special extension cable must be used. The maximum extensible length varies according to the Sensor and Cable Models being used. (Refer to the Specifications Section for details.)

Cable Connection

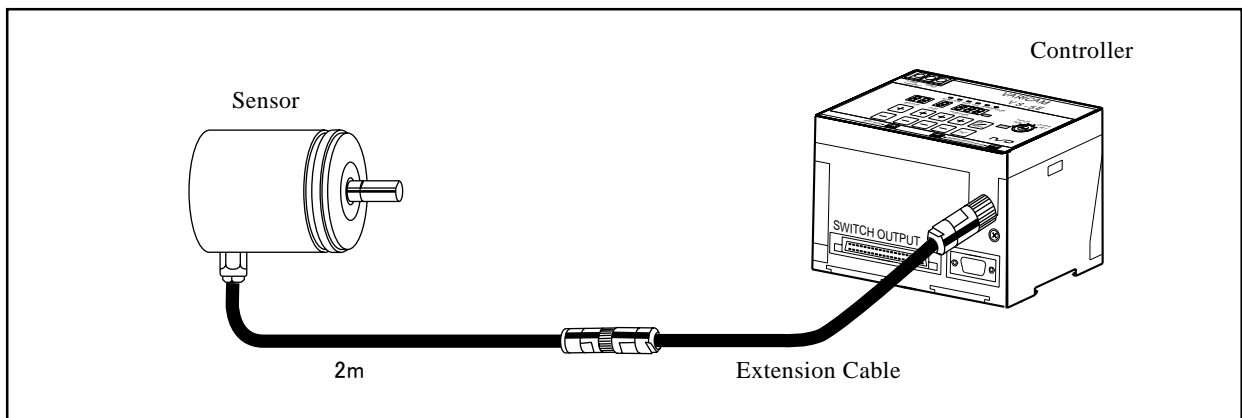

6-3. Connector Connections

6-3-1. Connector Names & Functions

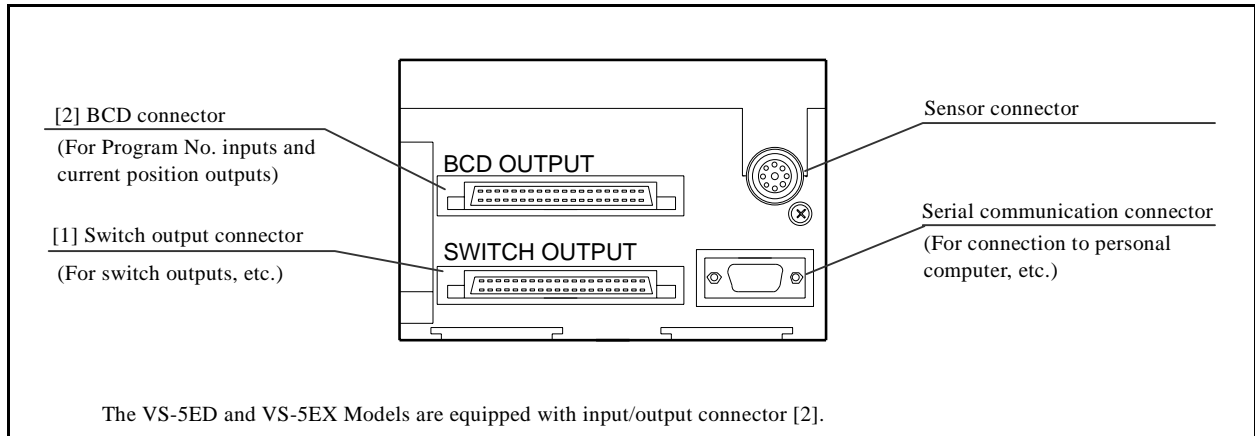

6-3-2. Signal Names & Descriptions

Name		Description	Applicable Model		
			VS-5E	VS-5ED	VS-5EX
Outputs	Switch outputs	ON/OFF signal outputs occur according to setting values.			
	System Ready signal	Output when Controller and Sensor are functioning normally.			
	Timing pulse	Outputs 60, 180, or 360 pulse signals per revolution.			
	Current position value	BCD 3-digit + 0.5 degree unit signal output for current position display.			
	Latch pulse	Latch pulse for current position output. The current position value is stable at the leading edge of this pulse.			
	Program No.	The currently selected Program No. is output.			
Inputs	Program No.	External Program No. input.			
	Current position HOLD	Used to prevent the current position value from changing while it is being read by the Programmable Controller.			or
	External origin set	Used for external origin setting inputs.			

6-3-3. Circuit Diagram

(1) Outputs

[1] Switch outputs, System Ready, timing pulse, and Program No.

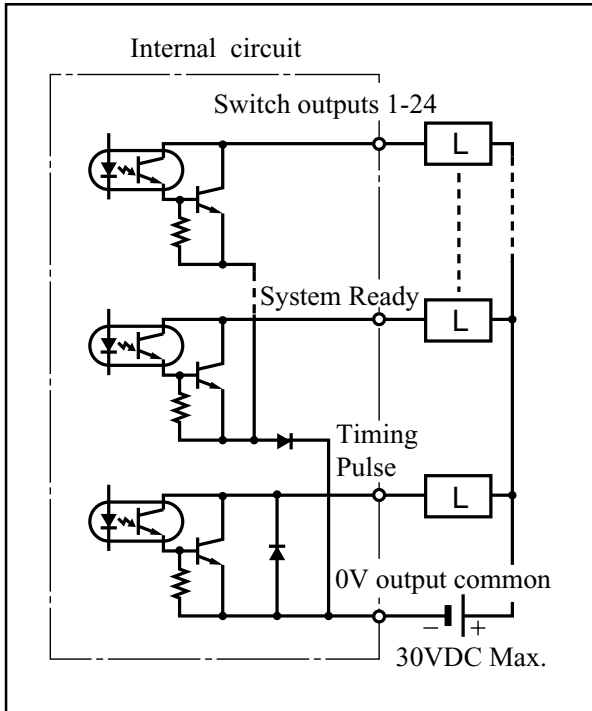

[2] Current position and latch pulse

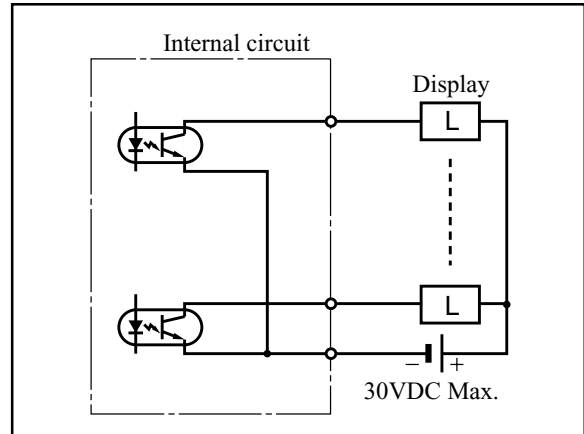

(2) Inputs

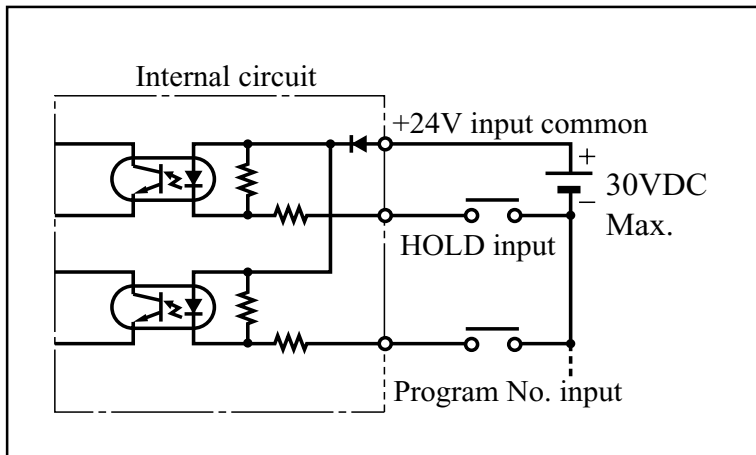

6-3-4. Connector Pin Configuration & Signal Names

(1) For VS-5E and VS-5ED Models

[1] Switch Output Connector (for VS-5E and VS-5ED)

[Connector Model: FCN361J040-AU/FCN-360C040-E] (Fujitsu Co.)

Pin No.	Signal Name	Pin No.	Signal Name
B20	Switch output 1	A20	Switch output 17
B19	Switch output 2	A19	Switch output 18
B18	Switch output 3	A18	Switch output 19
B17	Switch output 4	A17	Switch output 20
B16	Switch output 5	A16	Switch output 21
B15	Switch output 6	A15	Switch output 22
B14	Switch output 7	A14	Switch output 23
B13	Switch output 8	A13	Switch output 24
B12	Switch output 9	A12	
B11	Switch output 10	A11	
B10	Switch output 11	A10	
B9	Switch output 12	A9	
B8	Switch output 13	A8	
B7	Switch output 14	A7	
B6	Switch output 15	A6	System ready
B5	Switch output 16	A5	Timing pulse
B4		A4	0V common
B3		A3	0V common
B2		A2	0V common
B1		A1	0V common

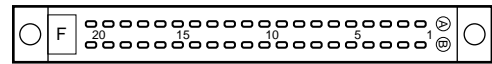

This drawing shows the arrangement of pins as viewed from the soldering terminals.

(Connector diagram)

Cable color and marking when external cable is used

Pin No.	Cable Color & Marking	Pin No.	Cable Color & Marking
B20	Pink (Black ■■■■)	A20	Pink (Red ■■■■)
B19	Yellow (Black ■■■■)	A19	Yellow (Red ■■■■)
B18	White (Black ■■■■)	A18	White (Red ■■■■)
B17	Gray (Black ■■■■)	A17	Gray (Red ■■■■)
B16	Orange (Black ■■■■)	A16	Orange (Red ■■■■)
B15	Pink (Black ■■■■)	A15	Pink (Red ■■■■)
B14	Yellow (Black ■■■■)	A14	Yellow (Red ■■■■)
B13	White (Black ■■■■)	A13	White (Red ■■■■)
B12	Gray (Black ■■■■)	A12	Gray (Red ■■■■)
B11	Orange (Black ■■■■)	A11	Orange (Red ■■■■)
B10	Pink (Black ■■■■)	A10	Pink (Red ■■■■)
B9	Yellow (Black ■■■■)	A9	Yellow (Red ■■■■)
B8	White (Black ■■■■)	A8	White (Red ■■■■)
B7	Gray (Black ■■■■)	A7	Gray (Red ■■■■)
B6	Orange (Black ■■■■)	A6	Orange (Red ■■■■)
B5	Pink (Black ■■■■)	A5	Pink (Red ■■■■)
B4	Yellow (Black ■■■■)	A4	Yellow (Red ■■■■)
B3	White (Black ■■■■)	A3	White (Red ■■■■)
B2	Gray (Black ■■■■)	A2	Gray (Red ■■■■)
B1	Orange (Black ■■■■)	A1	Orange (Red ■■■■)

(External cables can be used at either the switch output connector or the BCD connector.)

[2] BCD Connector (VS-5ED is equipped with this connector)

[Connector Model: FCN361J040-AU/FCN-360C040-E] (Fujitsu Co.)

Pin No.	Signal Name	Pin No.	Signal Name
B20		A20	Current position output 0.5
B19		A19	Current position output 1
B18		A18	Current position output 2
B17		A17	Current position output 4
B16		A16	Current position output 8
B15		A15	Current position output 10
B14		A14	Current position output 20
B13		A13	Current position output 40
B12		A12	Current position output 80
B11	Timing pulse	A11	Current position output 100
B10		A10	Current position output 200
B9	Current position HOLD input	A9	Latch pulse
B8	Program No.input 1	A8	Program No.output 1
B7	Program No.input 2	A7	Program No.output 2
B6	Program No.input 4	A6	Program No.output 4
B5		A5	
B4		A4	
B3		A3	
B2	24V input common	A2	0V output common
B1	24V input common	A1	0V output common

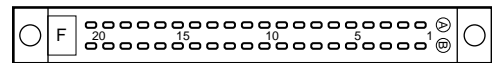

This drawing shows the arrangement of pins as viewed from the soldering terminals.

(Connector diagram)

This output is the same signal at A5.

(2) For VS-5EX Model

● When using a 16-Program, 40-switch output format

[1] Switch Output connector

[Connector Model: FCN361J040-AU/FCN-360C040-E] (Fujitsu Co.)

Pin No.	Signal Name	Pin No.	Signal Name
B20	Switch output 1	A20	Switch output 17
B19	Switch output 2	A19	Switch output 18
B18	Switch output 3	A18	Switch output 19
B17	Switch output 4	A17	Switch output 20
B16	Switch output 5	A16	Switch output 21
B15	Switch output 6	A15	Switch output 22
B14	Switch output 7	A14	Switch output 23
B13	Switch output 8	A13	Switch output 24
B12	Switch output 9	A12	Switch output 25
B11	Switch output 10	A11	Switch output 26
B10	Switch output 11	A10	Switch output 27
B9	Switch output 12	A9	Switch output 28
B8	Switch output 13	A8	Switch output 29
B7	Switch output 14	A7	Switch output 30
B6	Switch output 15	A6	Switch output 31
B5	Switch output 16	A5	Switch output 32
B4		A4	0V common
B3		A3	0V common
B2		A2	0V common
B1		A1	0V common

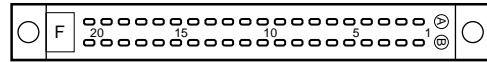

This drawing shows the arrangement of pins as viewed from the soldering terminals.

(Connector diagram)

[2] BCD Connector

[Connector Model: FCN361J040-AU/FCN-360C040-E] (Fujitsu Co.)

Pin No.	Signal Name	Pin No.	Signal Name
B20	Switch output 33	A20	Current position output 0.5 (Speed binary output 1)
B19	Switch output 34	A19	Current position output 1 (Speed binary output 2)
B18	Switch output 35	A18	Current position output 2 (Speed binary output 4)
B17	Switch output 36	A17	Current position output 4 (Speed binary output 8)
B16	Switch output 37	A16	Current position output 8 (Speed binary output 16)
B15	Switch output 38	A15	Current position output 10 (Speed binary output 32)
B14	Switch output 39	A14	Current position output 20 (Speed binary output 64)
B13	Switch output 40	A13	Current position output 40 (Speed binary output 128)
B12	System ready	A12	Current position output 80 (Speed binary output 256)
B11	Timing pulse	A11	Current position output 100 (Speed binary output 512)
B10		A10	Current position output 200 (Speed binary output 1024)
B9	Current position HOLD input	A9	Latch pulse
B8	Program No.input 1	A8	Program No.output 1
B7	Program No.input 2	A7	Program No.output 2
B6	Program No.input 4	A6	Program No.output 4
B5	Program No.input 8	A5	Program No.output 8
B4		A4	
B3		A3	
B2	24V input common	A2	0V output common
B1	24V input common	A1	0V output common

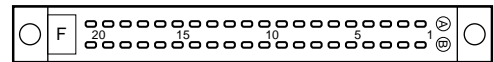

This drawing shows the arrangement of pins as viewed from the soldering terminals.

(Connector diagram)

As shown below when the " external origin set " function is used.

B9	External origin set input
----	---------------------------

● When using a 32-Program, 24-switch output format

[1] Switch Output connector

[Connector Model: FCN361J040-AU/FCN-360C040-E] (Fujitsu Co.)

Pin No.	Signal Name	Pin No.	Signal Name
B20	Switch output 1	A20	Switch output 17
B19	Switch output 2	A19	Switch output 18
B18	Switch output 3	A18	Switch output 19
B17	Switch output 4	A17	Switch output 20
B16	Switch output 5	A16	Switch output 21
B15	Switch output 6	A15	Switch output 22
B14	Switch output 7	A14	Switch output 23
B13	Switch output 8	A13	Switch output 24
B12	Switch output 9	A12	
B11	Switch output 10	A11	
B10	Switch output 11	A10	
B9	Switch output 12	A9	
B8	Switch output 13	A8	
B7	Switch output 14	A7	
B6	Switch output 15	A6	
B5	Switch output 16	A5	
B4		A4	0V common
B3		A3	0V common
B2		A2	0V common
B1		A1	0V common

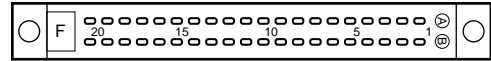

This drawing shows the arrangement of pins as viewed from the soldering terminals.

(Connector diagram)

[2] BCD Connector

[Connector Model: FCN361J040-AU/FCN-360C040-E] (Fujitsu Co.)

Pin No.	Signal Name	Pin No.	Signal Name
B20		A20	Current position output 0.5 (Speed binary output 1)
B19		A19	Current position output 1 (Speed binary output 2)
B18		A18	Current position output 2 (Speed binary output 4)
B17		A17	Current position output 4 (Speed binary output 8)
B16		A16	Current position output 8 (Speed binary output 16)
B15		A15	Current position output 10 (Speed binary output 32)
B14		A14	Current position output 20 (Speed binary output 64)
B13		A13	Current position output 40 (Speed binary output 128)
B12	System ready	A12	Current position output 80 (Speed binary output 256)
B11	Timing pulse	A11	Current position output 100 (Speed binary output 512)
B10		A10	Current position output 200 (Speed binary output 1024)
B9	Current position HOLD input	A9	Latch pulse
B8	Program No.input 1	A8	Program No.output 1
B7	Program No.input 2	A7	Program No.output 2
B6	Program No.input 4	A6	Program No.output 4
B5	Program No.input 8	A5	Program No.output 8
B4	Program No.input 16	A4	Program No.output 16
B3		A3	
B2	24V input common	A2	0V output common
B1	24V input common	A1	0V output common

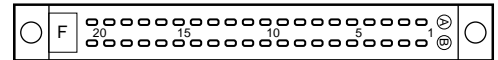

This drawing shows the arrangement of pins as viewed from the soldering terminals.

(Connector diagram)

As shown below when the " external origin set " function is used.

B9	External origin set input
----	---------------------------

6-3-5. Signal Timing

(1) Program No. Input & Switch Output (For VS-5ED and VS-5EX)

When the Program No. is changed by an external input, the output timing will be as shown below.

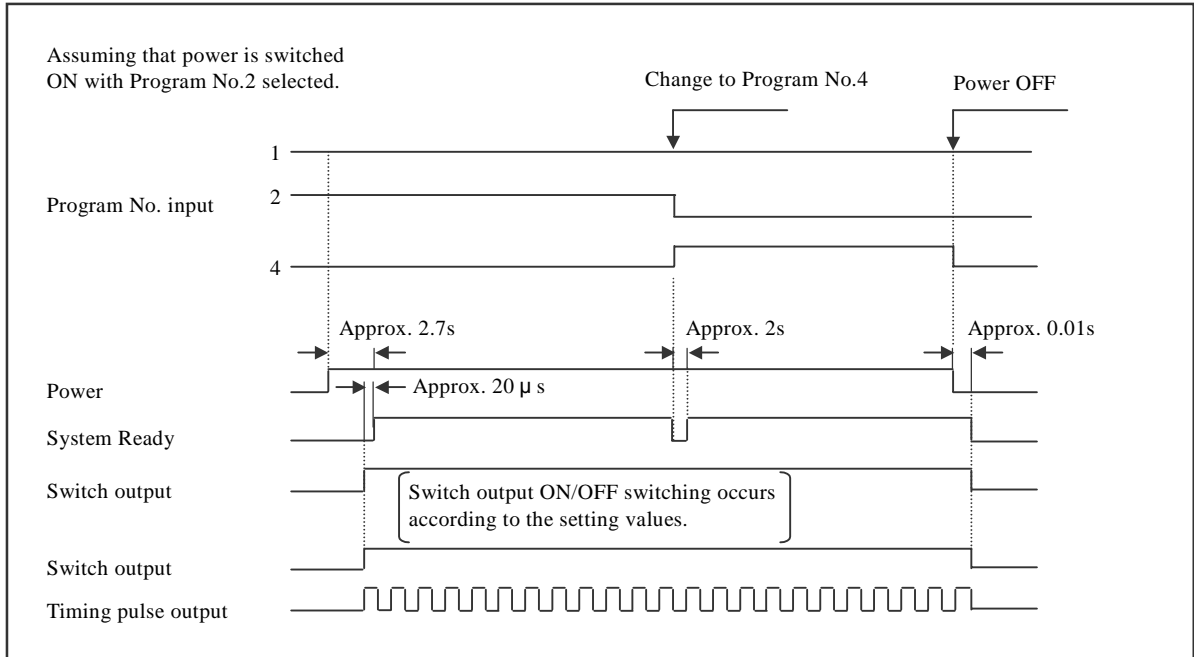

Note: When the Program No. is changed, the System Ready signal switches OFF for approximately 2 seconds, and a “HOLD” status is established for the switch outputs and timing pulse. Use care when designating the signal inputs.

(2) Current Position Output & Latch Pulse (For VS-5ED & VS-5EX)

The current position value stabilizes at the leading edge of the latch pulse. Therefore, the current position value should be read at that time.

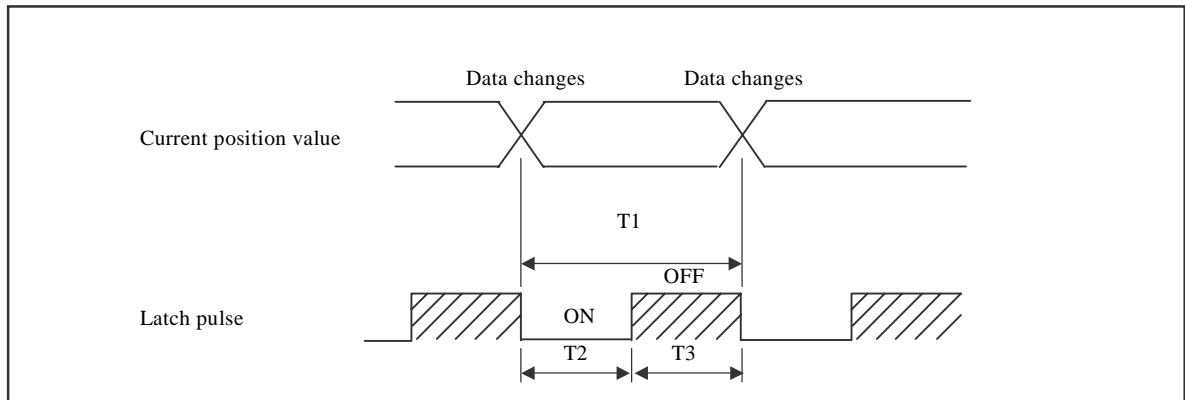

$$T2 = T1 \div 2$$

(The T1 initial setting should be designated as 0.352ms, 17.6ms, or 35.2ms.)

(3) Current Position Output When HOLD Input is Operative

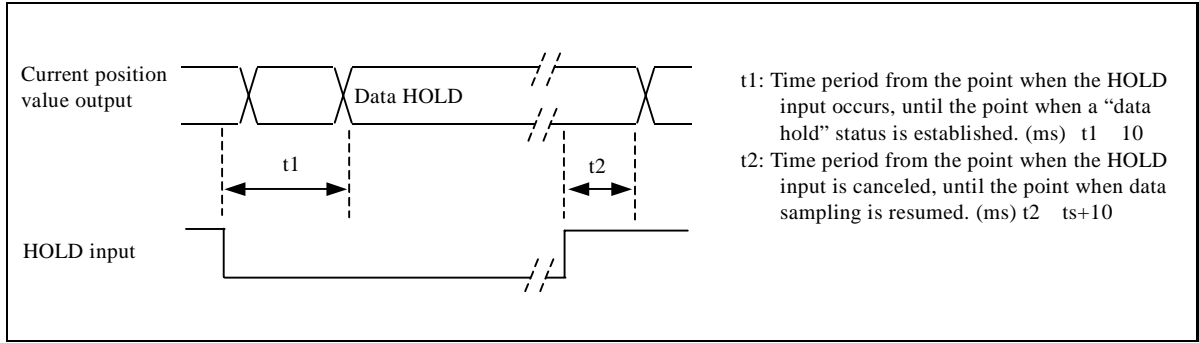

(4) Current Position Output When "External Origin Set" Input Occurs

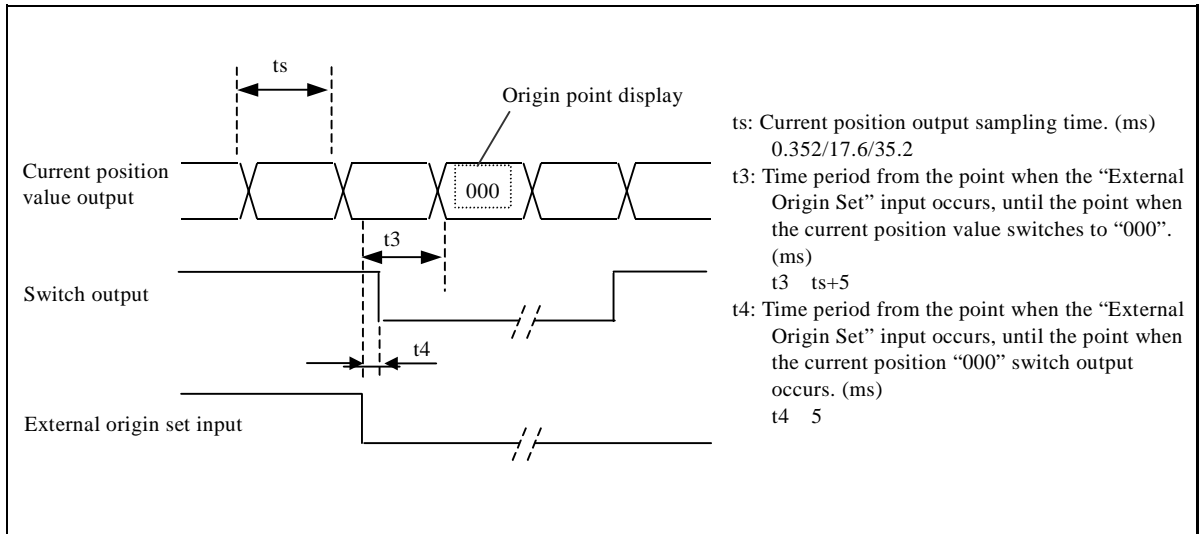

C. Operation Section

Unless otherwise specified, the operation procedures described in this section apply to the VS-5ED Model.

If the VS-5E Model is being used, please ignore the PROGRAM display items.

Operation procedures for the VS-5EX Model are identical to those for the VS-5ED Model.

7. Operating Sequence (Flowchart)

An operation flowchart is shown below. The Basic operation steps are shown in the shaded boxes. For advanced operations, the steps shown in the boxes are also required.

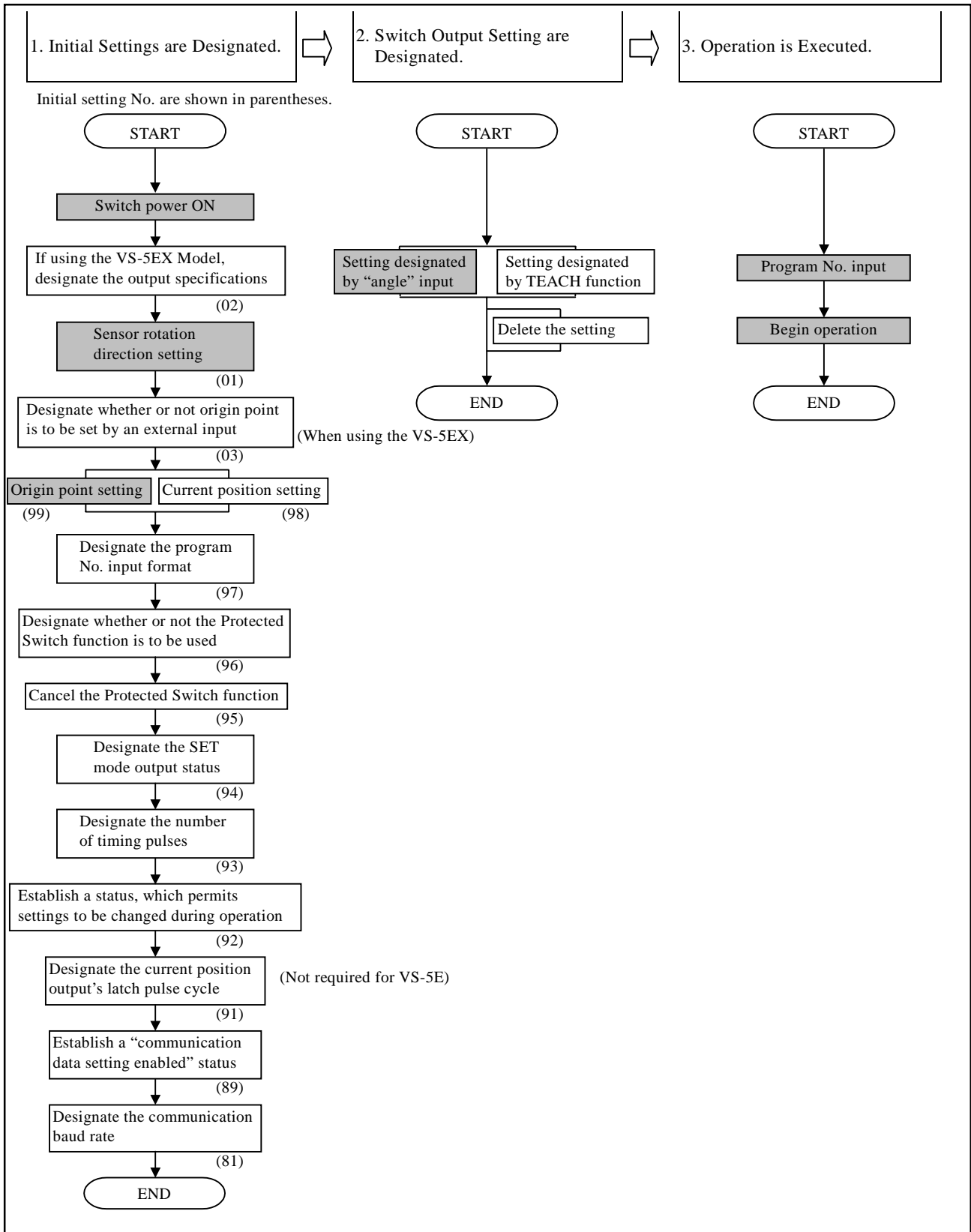

8. Operation

The VS-5E Series becomes operative when the following 5 operations are performed.

Item	Description
1) Switch power ON	
2) Set the sensor rotation direction	Designate the direction in the angular value increases.
3) Set the origin point	Move the machine to the origin point position, then designate that position as “zero” at the Controller.
4) Set the switch outputs	Set the Switch ON/OFF positions.
5) Run	

8-1. Power ON

The VS-5E Series is not equipped with a power switch. Power ON/OFF switching is executed by an external switch.

Note: Before switching the power ON, be sure that the wiring is correct, and the terminals are secure.

8-2. Sensor Rotation Direction Setting

Designate the sensor rotation direction in which the angular value is to increase.

- 1** Set the key-switch to the INIT position.

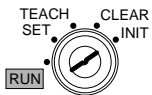

Set the mode selector key-switch to the INIT position in order to designate the rotation direction.

- 2** Enter the initial No.



SWITCH

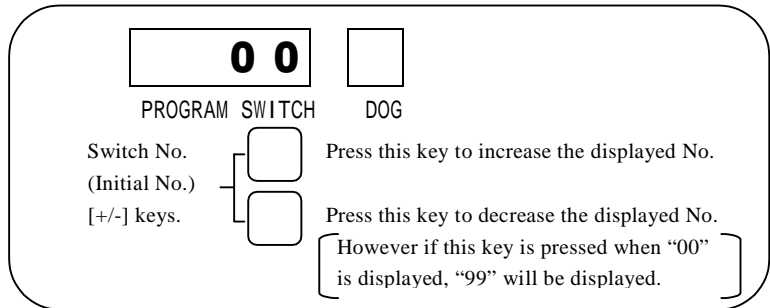
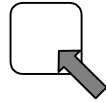

- 3** Designate the setting content.



DOG

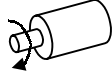
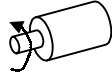

Each time the [ON/OFF] key is pressed, the display will alternate between “0” and “1”.

Setting Value	Description
0	 CW direction
1	 CCW direction

8-3. Origin Point Setting

Move the machine to the desired origin point position and designate that position as the origin point. The key-switch should be left at the INIT position for this operation.

- 1** Verify that the Absocoder sensor is connected.

If not connected, a “sensor error” will occur, and setting will be impossible.

- 2** Move the machine to the origin point position.

- 3** Designate initial No.”99”.

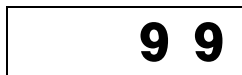

SWITCH

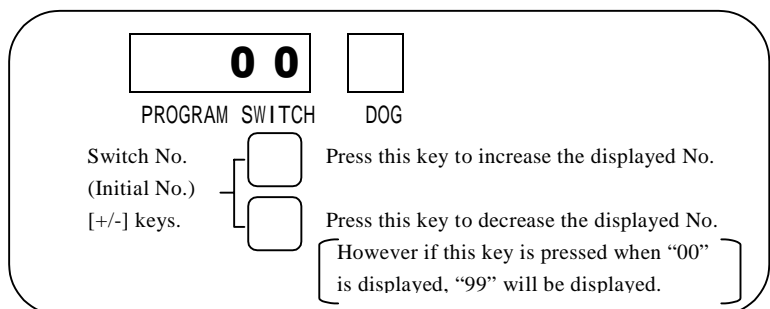
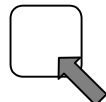

- 4** Press the [set] key.



At this time, “000” will be indicated at the POSITION display, and the origin setting operation is completed.

8-4. Switch Output Setting

- 1** Set the key-switch to the SET position.

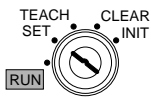

Setting Example

ON Position	125.5
OFF Position	234.5

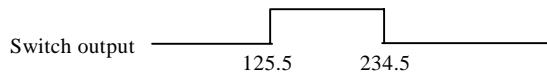

- 2** Designate the Program No.

1

PROGRAM

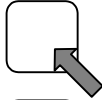

Program No. range:

Doesn't apply to VS-5E Model.	
VS-5ED.....	0 ~ 7
VS-5EX.....	00 ~ 15 or 00 ~ 31

- 3** Designate the switch No.

1 0 7

SWITCH

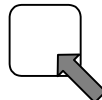

Switch No. range:

VS-5E.....	01 ~ 24
VS-5ED.....	01 ~ 24
VS-5EX.....	01 ~ 40 or 01 ~ 24

- 4** Designate the ON position value.



1 2 5 . **0.5**

POSITION



- If the ON LED is not lit, press the [ON/OFF] key.
- A 0.5 degree unit setting is displayed with a decimal point.
- Designate the ON and OFF position values in order, beginning from the smallest value.

- 5** Press the [SET] key.



6 Press the [ON/OFF] key.

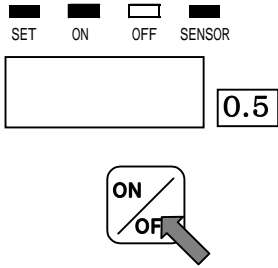

- This establishes the OFF position setting mode.
The OFF LED should be lit at this time.

7 Designate the OFF position value.

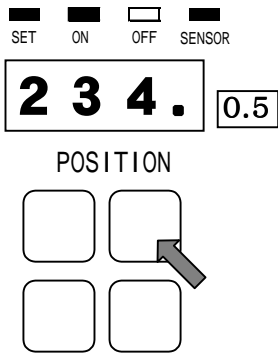

8 Press the [SET] key.



The designated OFF position value is registered.

8-5. Run

Switch outputs will switch ON and OFF according to the designated setting values during Run.

1 Select the desired Program No.

Not required for VS-5E Model.

Set the key-switch to the SET position.

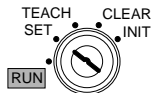

Select the desired Program No.

PROGRAM

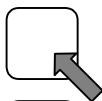

2 Set the key-switch to the RUN position.

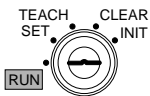

The “current position value” will then be displayed at the POSITION display area.

Switch outputs will switch ON and OFF according to the designated setting values.

The timing pulse output will switch ON and OFF according to the current position value.

[RUN Mode Display]

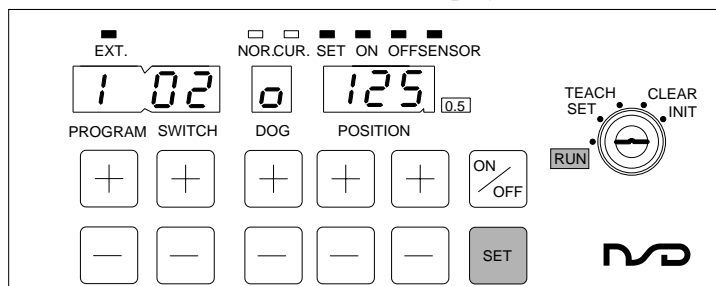

To check a Switch output status while in the RUN mode, designate the desired Switch No. The output status for that Switch will then be displayed at the “Dog” display area.

ON : DOG OFF : DOG

9. Advanced Operation

9-1. Initial Settings

In order to use the VALICAM functions, those required functions must first be designated at the initial settings. In this section, the initial setting procedure will be explained.

In the Initial Setting List shown below, the factory setting values (default values) are shown in []. Unless another setting is desired, these setting items can be skipped.

9-1-1. Initial Setting List

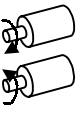
Initial No.	Item	Description	Setting	Applicable Model			Setting Procedure page No.
				VS-5E	VS-5ED	VS-5EX	
0 1	Sensor rotation direction	Designate the sensor rotation direction in which the current position value is to increase.	 CW direction:[0] CCW direction:1				8-2
0 2	VS-5EX output specifications	Select either the “16-Program, 40-Switch” or the “32-Program, 24-Switch” format. When using the VS-5EX Model, this setting should be designated first, immediately after delivery.	16-Program, 40-Switch: [0] 32-Program, 24-Switch: 1				9-1-3
0 3	“Current position HOLD/External origin set” selection	- Designate which of these functions is to be used. (Both functions cannot be designated.) - When the “External origin set” function is selected, setting changes cannot be made during RUN operation. (Refer to Initial No.92.)	Current position HOLD: [0] External Origin Set : 1				9-1-2
9 9	Origin point setting	Rotate the sensor to the desired origin point position and designate that position as the origin point (000).	Setting must be designated by one of these 2 formats.				8-3
9 8	Current position setting	The current position value for any desired sensor position can be designated by entering that value.					9-1-6
9 7	Program No. input format	Designate the format to be used for selecting the No. of the Program to be run.	By panel key input: [0] By external connector input: 1 By serial communication: 2	See note			9-1-2
9 6	Protected switch	Designate whether or not the Protected Switch function is to be used. The Protected Switch function can be used for Switch Nos. 1-10.	protected Switch function INVALID: [0] VALID: 1				9-1-4 9-1-5
9 5	Protected Switch Cancel	This setting is designated to cancel the Protected Switch function so that the Protected Switch setting value can be changed. Immediately after canceling the Protected Switch function, the key-switch should be set to the SET or TEACH position in order to change the setting value. If the key-switch is set to the RUN position, the “cancel” command will be invalid.	Do not cancel: [0] Cancel: 1				9-1-2

Note: To change a setting value by serial communication during operation, a setting of “2” is required.

Initial No.	Item	Description	Setting	Applicable Model			Setting Procedure page No.
				VS-5E	VS-5ED	VS-5EX	
9 4	Output status in SET mode	Select the output status, which is to exist when the key-switch setting is changed from the RUN mode to another mode. - If the “output HOLD” status is selected, the status, which existed just prior to switching from the RUN mode, will be maintained. - The current position value output will not be held.	Output OFF: [0] Output HOLD: 1				9-1-2
9 3	Timing pulse	Designate the number of pulses to be output per revolution.	360: [0] 180: 1 60: 2				
9 2	Setting Change during operation	This setting determines whether or not switch output settings can be changed during operation. If an “enabled” setting is designated, setting values can be changed in 0.5 degree units during operation. Setting changes during operation are impossible for the VS-5EX Model when in the “external origin set” mode.	Change disable: [0] Change enable: 1				
9 1	Latch pulse cycle	Designate the latch pulse cycle for the current position output. A changeable latch pulse cycle format is used in order to facilitate easy reading of the current position value.	0.352ms: [0] 17.6ms: 1 35.2ms: 2				
8 9	Communication setting	This setting is required when setting are to be designated by a communication format. - All settings, including initial settings, can be designated by a communication format. - This setting will be invalid if the key-switch setting is changed from the INIT mode to another mode.	Setting disabled: [0] Setting enabled: 1				
8 1	Communication baud rate	This setting is required when the communication format is used.	9600bps: [0] 4800bps: 1 2400bps: 2				
7 8	Display output logic	Designate the desired output logic for the Current Position or the Speed output.	Positive logic: [0] Negative logic: 1				
0 4	Display content	Switching between a “current position BCD output” and a “speed binary output” is possible.	Current position BCD: [0] Speed Binary: 1				

Note: If the key-switch is set to the INIT position, Initial No. “00” will be displayed.

9-1-2. Basic Initial Setting Procedure

Initial settings are designated as described below.

1 Set the key-switch to the INIT position.

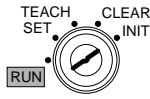

All initial settings are designated with the key-switch set to the INIT position.

2 Designate the Initial No.



SWITCH

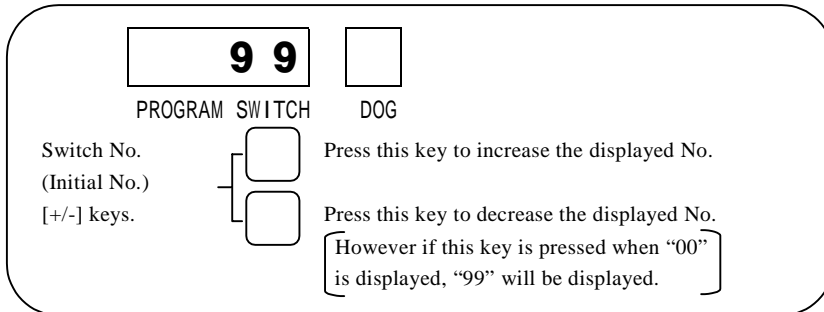
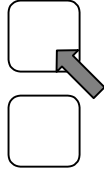

Warning!

Note: To select an initial No. of 96 or less, the following procedure is designated after initial No. 97 is displayed:

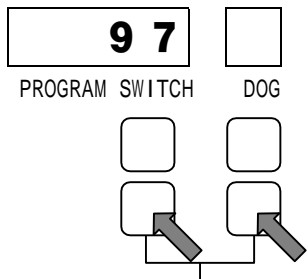

To decrease the initial No., press the DOG [-] and SWITCH [-] keys simultaneously.

3 Designate the setting content.



DOG

Each time the [ON/OFF] key is pressed, the display will change between the 0, 1, and 2 values.



The basic initial setting procedure is covered by steps [1] to [3] above.
For details regarding additional initial settings, refer to the following pages.

9-1-3. Designation of VS-5EX Output Specifications (Designated for VS-5EX Model Only)

The setting procedure described below should be executed immediately after delivery.

- 1** Set the key-switch to the INIT position.

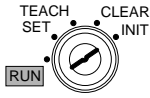

- 2** Designate Initial No. "2".



SWITCH

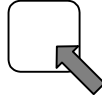

- 3** Designate the setting status.



DOG



Each time the [ON/OFF] key is pressed, the displayed value will alternate between 0 and 1.

0...16-Program, 40-Switch format

1...32-Program, 24-Switch format

- 4** While pressing the DOG [-] key, also press the [set] key.



DOG

The POSITION display will flash.

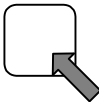

- 5** Press the [SET] key again.



The POSITION display will stop flashing, indicating that a setting has been designated.

Note: If the above "output specifications" setting is designated after other data setting have been made, those settings will have to be re-designated.

9-1-4. Protected Switch Function

- 1 Set the key-switch to the INIT position.

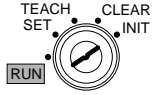

- 2 Designate Initial No. "96".

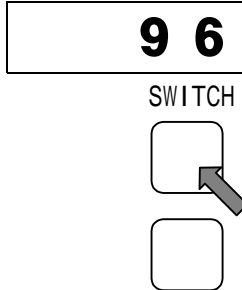

In order to select Initial No. "96", first designate "97", then execute the procedure shown below.

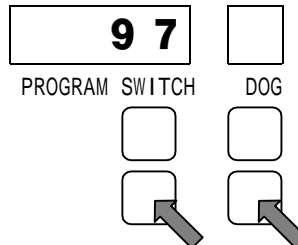

While pressing the Dog [-] key, also press the Switch [-] key. The displayed No. will change to "96".

- 3 Designate the password as "777".

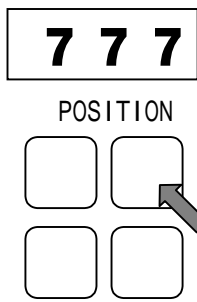

- 4 Press the [SET] key.



When the setting is designated, the value shown at the DOG display will change from 0 to 1, indicating that the Protected Switch function is operative.

9-1-5. Canceling the Protected Switch Function

- 1** Set the key-switch to the INIT position.

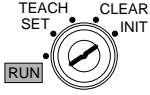

- 2** Designate Initial No. "96".

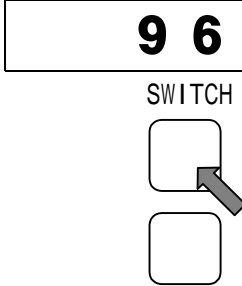

In order to select Initial No. "96", first designate "97", then execute the procedure shown below.

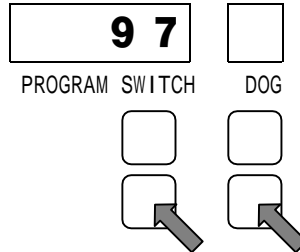

While pressing the Dog [-] key, also press the Switch [-] key. The displayed No. will change to "96".

- 3** Designate the password as "555".

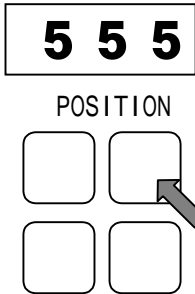

- 4** Press the [SET] key.



The value shown at the DOG display will change from 1 to 0, indicating that the Protected Switch function has been canceled.

9-1-6. Current Position Value Setting

This setting operation is the equivalent of the “origin set” operation. However, with this procedure, there’s no need to move the machine to the origin point position.

Instead, the current position value for a given position is designate by a numeric input.

1 Verify that the Absocoder sensor is connected.

If not connected, a “sensor error” will occur, and setting will be impossible.

2 Set the key-switch to the INIT position.

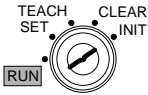

3 Designate Initial No. “98”.

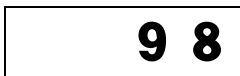

SWITCH



4 Use the POSITION keys to designate the desired current position value.

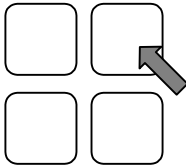

Permissible setting range: 000 to 359.5

5 Press the [SET] key.



The designated current position value will then be displayed as the value of the current STOP position.

(This completes the initial setting operations.)

9-2. Designating The Switch Output Settings

9-2-1. Setting The Switch Outputs by The TEACH Function

- 1** Set the key-switch to the TEACH position.

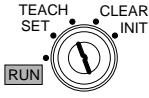

- 2** Select the desired Program No.

1

PROGRAM

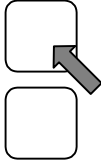

- 3** Select the desired switch No.

1 0 1

SWITCH

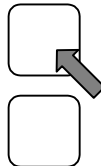

- 4** Press the POSITION key.

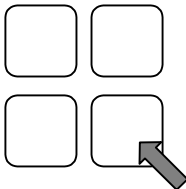

The current position value will be displayed.

- 5** Move the machine to the desired ON position.

NOR. CUR. SET ON OFF SENSOR

1 2 5

POSITION

The current position value will be displayed.

- 6** Press the [SET] key.



The ON position setting is registered.

7 Press the [ON/OFF] key.



When the OFF LED is lit, the OFF position setting mode will be established.

8 Press the POSITION key.

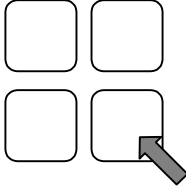

The current position value will be displayed.

9 Move the machine to the desired OFF position.

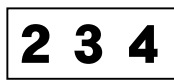

POSITION

10 Press the [SET] key.



The OFF position setting is registered.

Notes:

1. Multi-dog settings and deletions can also be executed with the key-switch set to the TEACH position. (Refer to section 9-2-3 for details.)
2. When the key-switch is set to the TEACH position, the current position output and the latch pulse will be ON. If an output HOLD status is in effect, the switch output and timing pulse output statuses will be maintained when a change from the RUN to the TEACH mode occurs. The System Ready output will switch OFF at this time.

9-2-2. Designating Multi-Dog Settings

When designating switch output settings, up to 10 ON/OFF settings can be made for each output. These multi-dog settings can be designated either by the normal switch output setting format, or by the TEACH format.

Set the key-switch to the SET or the TEACH position.

To designate a multi-dog setting, enter the dog No. after designating the switch No.

The setting procedure is described below.

- 1 Set the key-switch to the SET position (or TEACH position).**

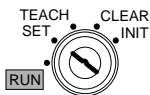

- 2 Designate the desired dog No.**

0

DOG

Permissible dog No. setting range: 0-9

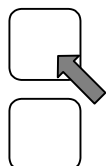

- 3 Set the ON position value.**

- 4 Press the [SET] key.**

- 5 Press the [ON/OFF] key.**

- 6 Set the OFF position value.**

- 7 Press the [SET] key.**

- 8 Designate the next dog No. setting.**

Repeat the above procedure for each dog No.

9-2-3. Canceling Multi-Dog Settings

The following procedure is used to cancel multi-dog settings. Set the key-switch to the SET or TEACH position.

- 1** Designate the dog No. to be canceled.
- 2** Designate the same setting value for both the ON and OFF positions.
- 3** Press the [SET] key.

Note: When a dog is canceled, the remaining dog Nos. will be adjusted (re-numbered).

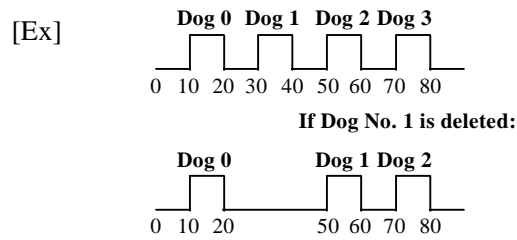

9-2-4. Canceling Switch Output Settings

The settings for a given switch No., and for all switch Nos. larger than that No. are canceled.

- 1** Set the key-switch to the CREAM position.

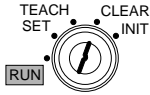

- 2** Select the desired Program No.

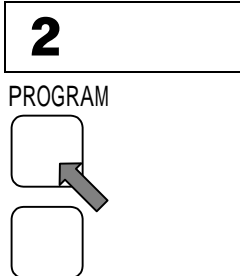

- 3** Select the desired switch No.

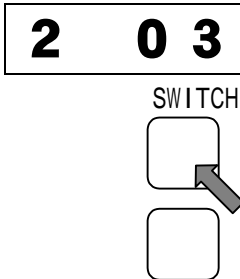

- 4** Press the [SET] key.



The POSITION display will begin to flash.

To abort the CREAM operation, turn the key-switch to another mode position.

- 5** Press the [SET] key again.

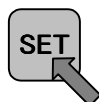

The setting will be canceled (cleared).

(In order to prevent accidental deletion of setting values, a format is used in which the [SET] key must be pressed twice.)

Notes:

1. When the key-switch is set to the CLEAR position, the current position output and the latch pulse will be ON. If an output HOLD status is in effect, the switch output and timing pulse output statuses will be maintained when a change from the RUN to the CLEAR mode occurs. The System Ready output will switch OFF at this time.
2. To cancel the settings for only one switch No., set the key-switch to the SET position, and designate the same value for both the ON and OFF positions of that switch No.

9-3. Executing Run

9-3-1. Checking Setting Values During Run

Although the current position value is normally displayed during Run mode, the switch output settings can also be displayed.

- 1** With current position value displayed, press the [SET] key.



The setting value will be displayed at the POSITION display. Press the [SET] key again to return to the current position value display.

- 2** Select the switch No. or dog No. to be displayed.

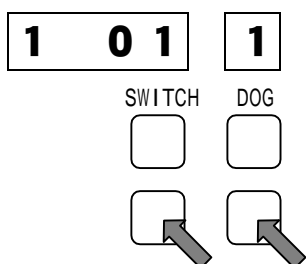

Designate the switch No. or dog No. to be displayed.

- 3** Press the [ON/OFF] key.



Each time the [ON/OFF] key is pressed, the display content will alternate between the ON and OFF position setting values.

9-3-2. Changing The Setting Values During Run

Setting values can be changed in 0.5 degree increments during Run, to enable fine adjustments. In order to perform this function, it must first be enabled by the Initial No. 92 setting. (For details, refer to sections 9-1-1 and 9-1-2.)

- 1** Press the [SET] key to switch to the “setting value” display mode.



- 2** Select the switch No. or dog No.

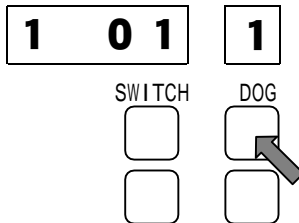

Select the switch No. or dog No. where a setting change is desired.

- 3** Press the [ON/OFF] key.



Designate whether the ON or OFF setting value is to be changed.

- 4** Press the key shown below to make the setting value flash.

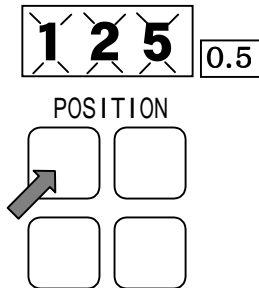

When the setting value is flashing, it can be changed in 0.5 degree units.

- 5** Change the setting value.

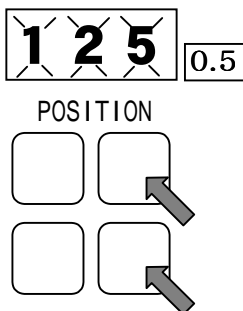

Press one of the above keys.

Press the [+] key to increase the value in 0.5 degree units.
Press the [-] key to decrease the value in 0.5 degree units.
(The 0.5 degree units setting is displayed with a decimal point.
At that time, the setting value is changed and output.)

- 6** Press the [SET] key.

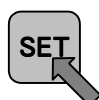

The setting value will stop flashing, and the system will return to the “current position” display mode.

9-3-3. Checking Switch Outputs From RUN Mode

The ON/OFF statuses of 6 switch outputs can be simultaneously displayed at the “Position” display area for verification.

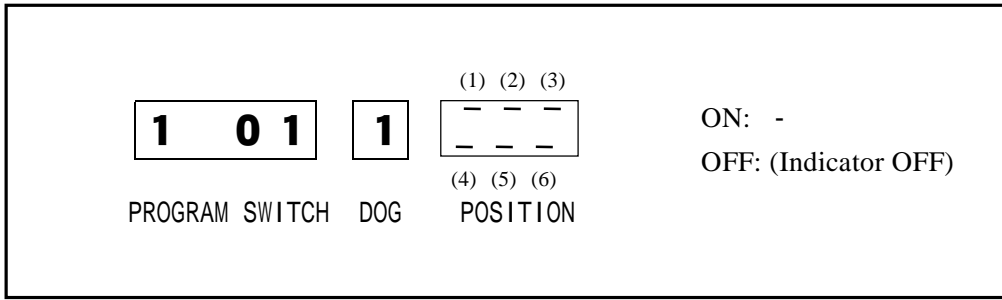

1 Press the [SET] key to switch to the ON/OFF status display mode.



Each time the [SET] key is pressed, the “Position” display content will change as follows:

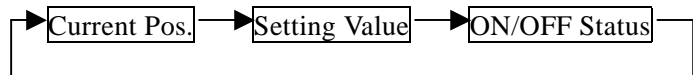

2 Designate the desired Switch No.

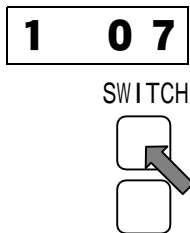

The ON/OFF statuses for 6 switch Nos. are displayed, beginning from the designated Switch No.

Setting Nos.: 01, 07, 13, 19.....

3 Check the Switch Output Status.

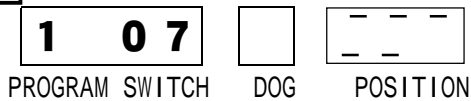

A status display such as that shown at left would indicate that Switch Nos. 7, 8, 9, 10, and 11 are ON, and Switch No. 12 is OFF.





10. Errors

Error causes and countermeasures are described below.

10-1. Error Displays & Countermeasures

When a Controller or Sensor error occurs, there will be an error display, and an error signal output. When this occurs, refer to the following Table to determine the cause and the appropriate countermeasure.

Error Displays, Causes, & Countermeasures Table

Error Display	Name	Output Status	Probable Cause	Countermeasure	Error Cancel Procedure
 flashing display "NOR." LED is OFF	Memory error	Switch outputs OFF Timing pulse output OFF System Ready output OFF	Memory data has been changed to due external noise, etc.	Cancel the error, and re-designate the settings beginning from the initial settings.	Press the [ON/OFF] key. All setting data will be deleted, and [000] will be displayed.
 flashing display "NOR." LED is OFF	Sensor error	Switch outputs OFF Timing pulse output OFF System Ready output OFF	1) Sensor connector is disconnected or loose. 2) Position sensor hardware malfunction.	1) Correct the error cause. 2) If caused by a Sensor or Controller malfunction, replace the malfunctioning unit.	After correcting the error cause, press the [ON/OFF] key.
 is flashing.	"No setting" error		During the switch output setting operation, an ON setting was designated without designating the corresponding OFF setting.	Cancel the error, and, after re-designating the ON position setting, designate the OFF position setting.	Press the [ON/OFF] key.
 is flashing.	Setting error		The position where a setting was attempted is outside the permissible setting range.	Cancel the error and designate a correct setting.	Press the [ON/OFF] key.

10-2. Setting Procedures After Replacing Sensor/Controller

After replacing the Sensor or Controller, the following setting items must be designated.

Item Replaced	Setting Required
Sensor	Re-designate the origin point setting.
Cable	
Controller	All setting items must be designated.



NSD Corporation

3-31-23, Osu, Naka-ku, Nagoya, Japan 460-8302
Phone: 052-261-2352 Facsimile: 052-252-0522

Artisan Technology Group - Quality Instrumentation ... Guaranteed | (888) 88-SOURCE | www.artisanng.com



Artisan Technology Group is your source for quality new and certified-used/pre-owned equipment

- FAST SHIPPING AND DELIVERY
- TENS OF THOUSANDS OF IN-STOCK ITEMS
- EQUIPMENT DEMOS
- HUNDREDS OF MANUFACTURERS SUPPORTED
- LEASING/MONTHLY RENTALS
- ITAR CERTIFIED SECURE ASSET SOLUTIONS

SERVICE CENTER REPAIRS

Experienced engineers and technicians on staff at our full-service, in-house repair center

*InstraView*SM REMOTE INSPECTION

Remotely inspect equipment before purchasing with our interactive website at www.instraview.com ↗

WE BUY USED EQUIPMENT

Sell your excess, underutilized, and idle used equipment. We also offer credit for buy-backs and trade-ins. www.artisanng.com/WeBuyEquipment ↗

LOOKING FOR MORE INFORMATION?

Visit us on the web at www.artisanng.com ↗ for more information on price quotations, drivers, technical specifications, manuals, and documentation

Contact us: (888) 88-SOURCE | sales@artisanng.com | www.artisanng.com