



## Artisan Technology Group is your source for quality new and certified-used/pre-owned equipment

- FAST SHIPPING AND DELIVERY
- TENS OF THOUSANDS OF IN-STOCK ITEMS
- EQUIPMENT DEMOS
- HUNDREDS OF MANUFACTURERS SUPPORTED
- LEASING/MONTHLY RENTALS
- ITAR CERTIFIED SECURE ASSET SOLUTIONS

### SERVICE CENTER REPAIRS

Experienced engineers and technicians on staff at our full-service, in-house repair center

### *InstraView*<sup>SM</sup> REMOTE INSPECTION

Remotely inspect equipment before purchasing with our interactive website at [www.instraview.com](http://www.instraview.com) ↗

### WE BUY USED EQUIPMENT

Sell your excess, underutilized, and idle used equipment. We also offer credit for buy-backs and trade-ins. [www.artisanng.com/WeBuyEquipment](http://www.artisanng.com/WeBuyEquipment) ↗

### LOOKING FOR MORE INFORMATION?

Visit us on the web at [www.artisanng.com](http://www.artisanng.com) ↗ for more information on price quotations, drivers, technical specifications, manuals, and documentation

**Contact us:** (888) 88-SOURCE | [sales@artisanng.com](mailto:sales@artisanng.com) | [www.artisanng.com](http://www.artisanng.com)

# ORIENTAL MOTOR GENERAL CATALOG

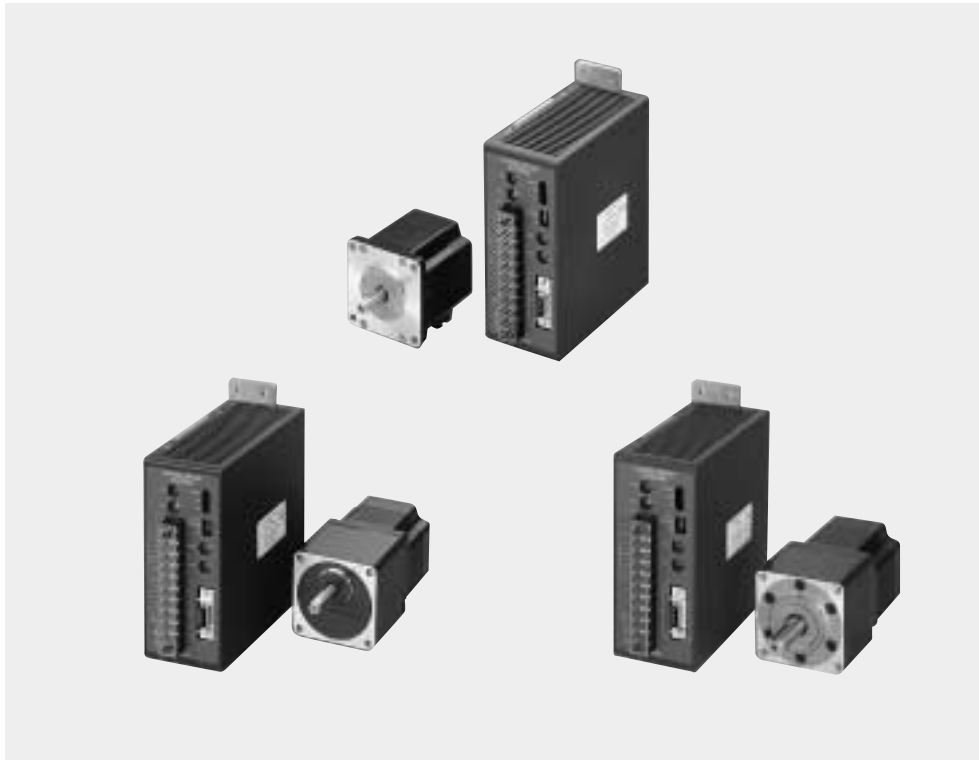

## NanoStep™ UFK•W

Features .....B-122  
 Standard Type .....B-126  
 Geared Type .....B-132  
 List of Motor and Driver Combinations .....B-145  
 Setting the Step Angle.....B-146  
 Wiring Diagram.....B-147  
 Description of Input/Output Signals.....B-148

QSTEP	5 φ with AC Driver
UPK•W	
UPK	
UFK•W	
PMU	5 φ with DC Driver
RFK	
CSK	
PMC	
UMK	2 φ with Driver
CSK	
Controllers	2 φ Stepping Motors
Low-Speed Synchronous Motors	
Accessories	

The **NanoStep UFK•W** uses 5-phase microstepping, the most advanced stepping motor drive technology available. It takes the basic 5-phase

stepping motor angle of  $0.72^\circ$  and divides it electrically into smaller step angles providing up to 125,000 steps per revolution.



## ■ What is NanoStep?

**NanoStep** is a series of stepping motors and drivers that combines high-performance 5-phase microstep drivers with high-torque/low-vibration 5-phase stepping motors. They provide smooth and precise operation.

## ■ 5-phase Microstep Drive Technology

The primary feature of stepping motors is the ability to obtain precise positioning. They achieve this by rotating and stopping at step angle increments that are determined by the pole structure of the rotor and stator. Rotating in step angle increments, however, also produces changes in rotor speed and resonance at certain speeds that can increase vibration.

Microstep driving provides a finer degree of control of the basic motor step angle by regulating the current sent to the motor coils, resulting in, low vibration, even at low speed.

- Since the basic motor step angle ( $0.72^\circ$ /full step) can be divided into proportions ranging from 1/1 to 1/250, smooth operation in fine increments is possible.
- Technology that changes the motor drive current smoothly suppresses motor vibration and makes operation audibly quieter.

## ■ Microstep Resolution Up to 125,000 Steps

**NanoStep UFK•W** enables step angles to be set independently on two resolution selection switches (16 possible microstep resolutions with as many as 250 microsteps per full step). This enables two independent resolutions to be selected by using the resolution select input. Changing resolution should occur when the motor is in the stop position. This will eliminate the chance of positioning error.

## ■ FEATURES

### 1. Low Vibration, Low Noise

Microstep technology allows the step angle to be subdivided electrically. This smoothes stepped operation at low speeds and drastically improves vibration. The **NanoStep UFK•W** uses a motor design that also helps to reduce vibration. Therefore the **NanoStep UFK•W** is ideal for applications where vibration is a problem.

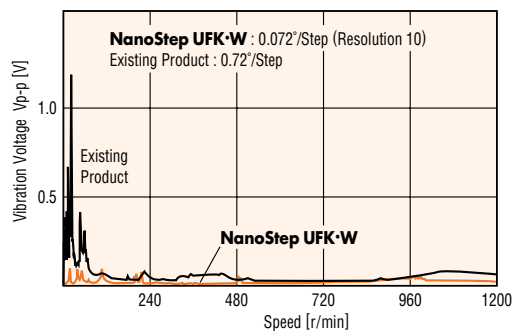

### 2. High Speed

The **NanoStep UFK•W** provides low vibration at both low and high speeds.

### 3. Standard Certified Product

This product is certified under applicable standards from around the world. Also, the CE marking is implemented according to the low voltage directive. (For details on standard certified products, see Page D-16.)

## ■ NanoStep<sup>™</sup> UFK•W SYSTEM CONFIGURATION

A high-torque 5-phase stepping motor and microstep driver are combined to make high-precision positioning with open loop control possible.

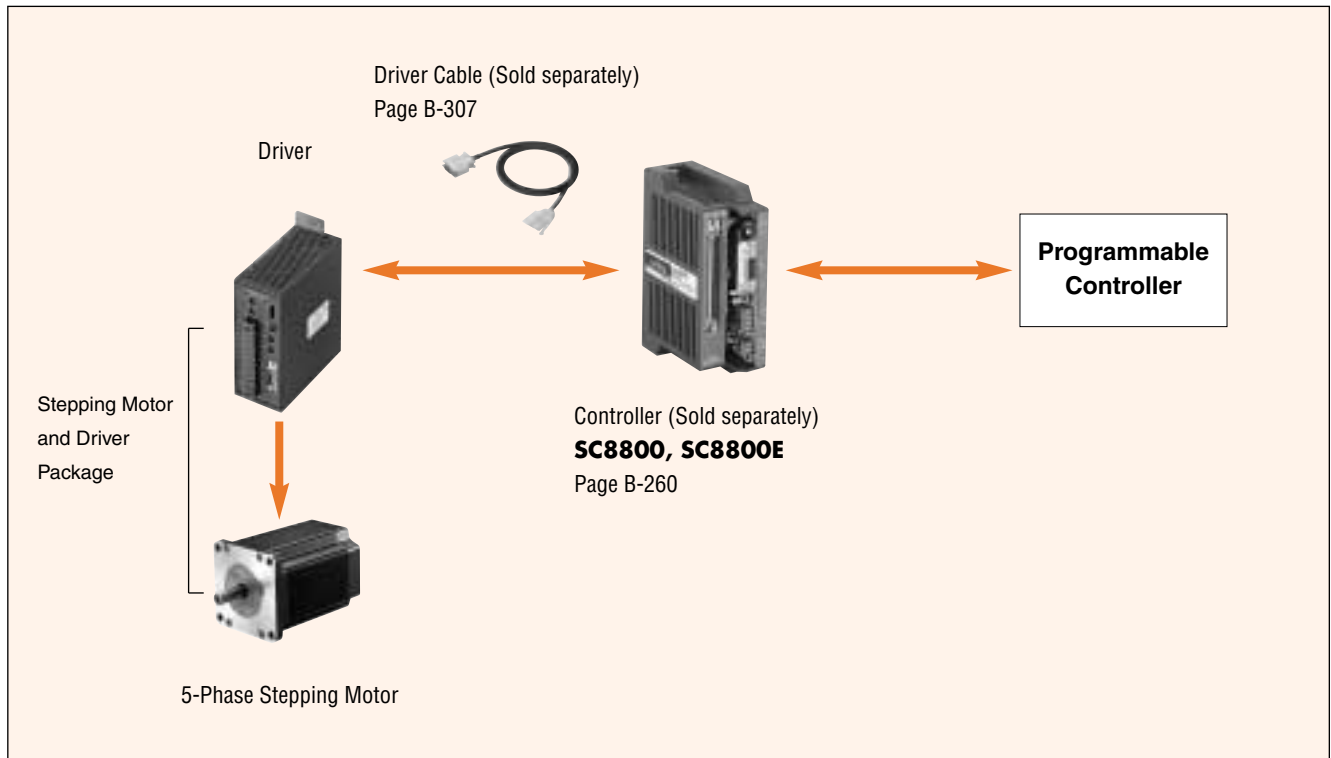

## ■ ACCESSORIES (Sold separately)

**Motor Mounting Bracket**

**Flexible Coupling**

- **Motor Mounting Brackets** Page B-298
- **Flexible Couplings** Page B-301
- **Extension Cables** Page B-306
- **Drive Cables** Page B-307

**MC Motor Couplings**

16.4 feet (5m), 32.8 feet (10m), 65.6 feet (20m) long

Flat cable for connecting the driver and controller.

Motor mounting bracket and flexible coupling cannot be fitted on to geared type.

■ PRODUCT LINE

# NanoStep™ UFK•W

## Standard Type

Page B-126

There are two motor frame sizes available: 2.36 inches (60 mm) and 3.35 inches (85 mm) square. They can handle low-speeds, low-vibration and low-noise applications.

Package Model	Maximum Holding Torque	
	oz-in	N-m
<b>UFK564</b> □ <b>W</b>	58.3	0.42
<b>UFK566</b> □ <b>W</b>	115	0.83
<b>UFK569</b> □ <b>W</b>	230	1.66
<b>UFK596</b> □ <b>W</b>	291	2.1
<b>UFK599</b> □ <b>W</b>	569	4.1
<b>UFK5913</b> □ <b>W</b>	874	6.3

● Enter **A** (single shaft) or **B** (double shaft) in the □ within the model numbers.

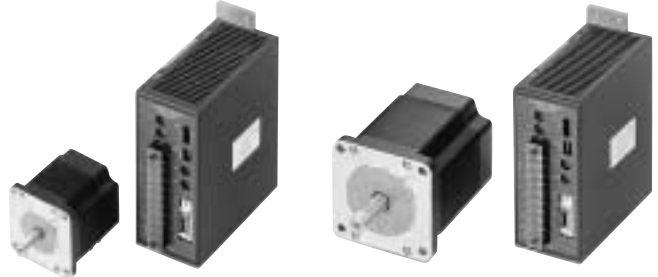

# NanoStep™ UFK•W

## TH Geared Type

Page B-132

This series combines the **UFK•W** with **TH** gears, which provide low speed reduction ratios (3.6:1, 7.2:1, 10:1, 20:1, and 30:1) and are low backlash (25 arc minutes max.)

Package Model	Permissible Torque	
	lb-in	N-m
<b>UFK564</b> □ <b>W-T3.6</b>	10.8	1.25
<b>UFK564</b> □ <b>W-T7.2</b>	21.6	2.5
<b>UFK564</b> □ <b>W-T10</b>	26	3
<b>UFK564</b> □ <b>W-T20</b>	30.3	3.5
<b>UFK564</b> □ <b>W-T30</b>	34.7	4
<b>UFK596</b> □ <b>W-T3.6</b>	39	4.5
<b>UFK596</b> □ <b>W-T7.2</b>	78.1	9
<b>UFK596</b> □ <b>W-T10</b>	78.1	9
<b>UFK596</b> □ <b>W-T20</b>	104	12
<b>UFK596</b> □ <b>W-T30</b>	104	12

● Enter **A** (single shaft) or **B** (double shaft) in the □ within the model numbers.



# NanoStep™ UFK•W

## PN Geared Type

Page B-132

The newly developed backlash reduction feature is utilized and attains backlash below 3 arc minutes. This is a major increase in precision.

Package Model	Permissible Torque	
	lb-in	N-m
<b>UFK566</b> □ <b>W-N5</b>	30.3	3.5
<b>UFK566</b> □ <b>W-N7.2</b>	30.3	3.5
<b>UFK566</b> □ <b>W-N10</b>	30.3	3.5
<b>UFK564</b> □ <b>W-N25</b>	52	6
<b>UFK564</b> □ <b>W-N36</b>	52	6
<b>UFK564</b> □ <b>W-N50</b>	52	6

● Enter **A** (single shaft) or **B** (double shaft) in the □ within the model numbers.

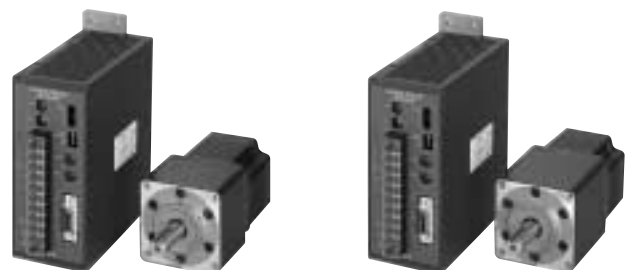

# The NanoStep™ UFK•W of Dedicated Drivers: Designed with User-Friendly Functions

Driver operating status is visible at a glance

**Signal monitor display** ————— 1

Easy to confirm I/O signals.

POWER: Power input display

TIM.: Excitation timing output display

O.H.: Overheat output display

**Motor operating current adjustment switch** ————— 2  
**Motor resting current adjustment switch**

The motor current is easy to adjust with digital switches. No ammeter necessary.

RUN: Can be adjusted the motor running current.

STOP: Can be adjusted the current at motor standstill.

**A full range of driver functions are on the front panel.**

**Pulse Input Method Switch** ————— 3

Switches between 1-pulse input and 2-pulse input.

**Automatic Current Off Switch** ————— 4

When the level of heat within the driver reaches 176°F (80°C), this function automatically switches the motor current off. The function can be set and disabled with this switch.

**Resolution Select Switch** ————— 5

Use these rotary switches to set the desired resolution from the 16 resolution levels available.

See page B-146 for details.

**Power Supply Terminals** ————— 6

Can be used with AC100V-115V ± 15% 50/60Hz.

**Protective Earthing Terminal** ————— 7

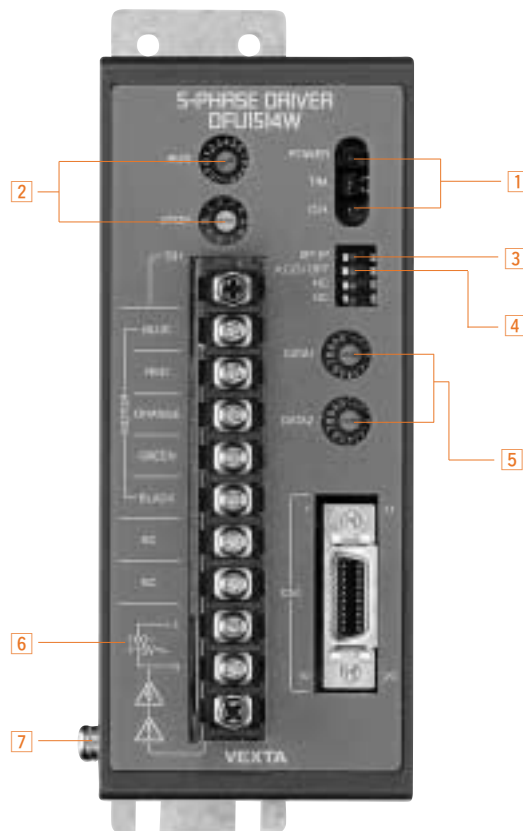

# NanoStep™ UFK•W Geared Type

This series combines the **UFK•W** motor and driver with **TH** and **PN** gears to provide high resolution, low vibration and low audible noise.

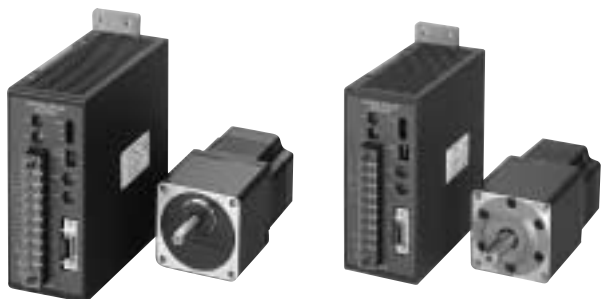

## ■ APPLICABLE STANDARDS AND CE MARKING

Products	Applicable Standards	Authorizing Organization	Standards File No.	CE Marking
Stepping Motor <b>TH</b> Geared <b>PN</b> Geared	UL1004, UL519 CAN/CSA-C22.2 No.100 CNA/CSA-C22.2 No.77	UL	E64199	Low Voltage Directive
	EN60950 EN60034-1, EN60034-5	VDE	6763ÜG	
Driver for Stepping Motor	UL508C CAN/CSA-C22.2 No.14	UL	E171462	Low Voltage Directive
	EN60950, EN50178	DEMKO	99-01497 99-01498	

### Note:

- See page D-9 for more information on operating conditions of EN/IEC standards.
- The EN/IEC standard certification depends on the type and installation size. For details, see Page D-16.
- The products are recognized when used together.

## ■ PRODUCT NUMBER CODE

**UFK 5 6 4 B W-T 7.2**

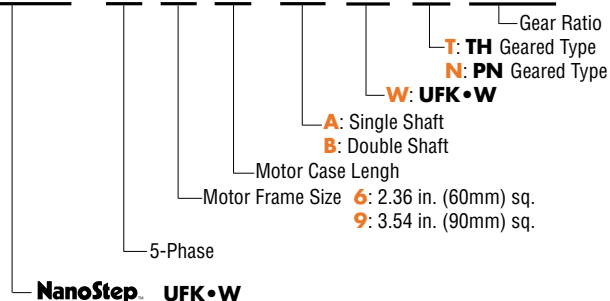

# TH Geared Type



See page B-136 to B-141 for products specification, characteristics and dimensions.

### ●High-precision positioning

A tapered gear is used for the gear output stage and the gear that merges with it to obtain high precision and low backlash operation. The backlash is 35 arc minutes (0.584°) - 10 arc minutes (0.167°) for a motor installation dimension of 2.36 in. (60mm) square and 25 arc minutes (0.417°) - 10 arc minutes (0.167°) for 3.54 in. (90mm). Backlash decreases as the speed reduction ratio increases.

### ●Five Gear Ratios

Five low gear ratios of 3.6:1, 7.2:1, 10:1, 20:1 and 30:1 are available. These gear ratios are convenient for applications requiring gearing without reducing of the motor speed.

# PN Geared Type



See page B-142 to B-145 for products specifications, characteristics and dimensions.

### ●Low backlash of 3 minutes or less

The **PN** geared type uses a newly developed backlash reduction structure to obtain backlash of 3 minutes (0.05°) or less. This is a major increase in precision compared to conventional planetary geared types with typical backlash of 20 arc minutes (0.33°).

### ●High permissible torque

Since the planetary gear structure transmits torque distributed over multiple planetary gears, it can provide large permissible torque.

For example **UFK564BW-N25** produces a maximum torque of 52 lb-in (6 N-m).

### ●Six gear ratios

The **PN** geared type, six gear ratios are available: 5:1, 7.2:1, 10:1, 25:1, 36:1 and 50:1. When the gear ratio of 7.2:1 is used, a step angle of 0.1° can be obtained for full step operation.

## ■ PRODUCT LINE

Package Model		Permissible Torque	
Single Shaft	Double Shaft	lb-in	N-m
<b>UFK564AW-T3.6</b>	<b>UFK564BW-T3.6</b>	10.8	1.25
<b>UFK564AW-T7.2</b>	<b>UFK564BW-T7.2</b>	21.6	2.5
<b>UFK564AW-T10</b>	<b>UFK564BW-T10</b>	26	3
<b>UFK564AW-T20</b>	<b>UFK564BW-T20</b>	30.3	3.5
<b>UFK564AW-T30</b>	<b>UFK564BW-T30</b>	34.7	4
<b>UFK596AW-T3.6</b>	<b>UFK596BW-T3.6</b>	39	4.5
<b>UFK596AW-T7.2</b>	<b>UFK596BW-T7.2</b>	78.1	9
<b>UFK596AW-T10</b>	<b>UFK596BW-T10</b>	78.1	9
<b>UFK596AW-T20</b>	<b>UFK596BW-T20</b>	104	12
<b>UFK596AW-T30</b>	<b>UFK596BW-T30</b>	104	12

## ■ PRODUCT LINE

Package Model		Permissible Torque	
Single Shaft	Double Shaft	lb-in	N-m
<b>UFK566AW-N5</b>	<b>UFK566BW-N5</b>	30.3	3.5
<b>UFK566AW-N7.2</b>	<b>UFK566BW-N7.2</b>	30.3	3.5
<b>UFK566AW-N10</b>	<b>UFK566BW-N10</b>	30.3	3.5
<b>UFK564AW-N25</b>	<b>UFK564BW-N25</b>	52	6
<b>UFK564AW-N36</b>	<b>UFK564BW-N36</b>	52	6
<b>UFK564AW-N50</b>	<b>UFK564BW-N50</b>	52	6



## ■ ABOUT THE GEARS

### ●TH Gears

Tapered gears are used for the final stage of the spur gear speed reduction mechanism to reduce backlash.

Gaps are required between gears to allow them to rotate smoothly. However, on the gear output shaft, these gaps become play known as backlash, and this is a problem when a control gear motor is used in applications requiring high positioning precision. The tapered gears used in the final stage are adjusted in the direction of the arrows shown in the figure below to reduce backlash.

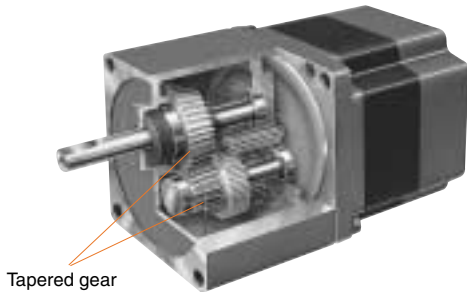

Tapered gear

**TH gear sectional diagram**

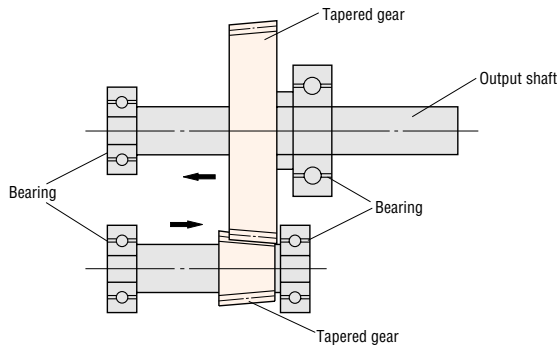

**The structure of the final stage of the TH gear**

### ●PN Gears

High-precision, high-strength **PN** (planetary) gears have been developed specially for five-phase stepping motors. Unlike ordinary spur gear mechanisms, planetary gears disperse torque over multiple planetary gears, so large torque can be obtained with minimal backlash. Moreover, since the gear output shaft is a center shaft, the same as the motor output shaft. This could be an advantage when mounting the motor.

Planetary gears have the following features.

- The overall size is small.
- High power can be continuously obtained.
- Noise is low.
- Weight is low.
- The input shaft and output shaft are on the same axis.

The **PN** gear type uses newly developed gears that utilize a backlash reduction mechanism. In this new structure there are two stages, upper and lower, for the internal gears and planetary gears.

The upper level internal gears and planetary gears reduce clockwise backlash; the lower level internal gears and planetary gear reduce counterclockwise backlash to attain backlash of 3 arc minutes or less.

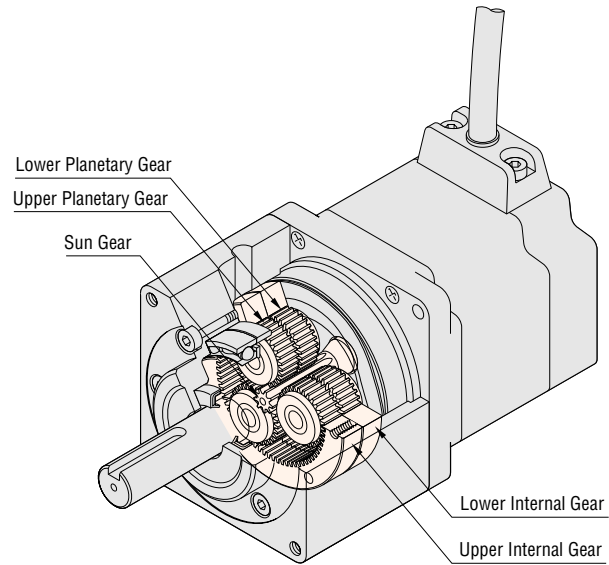

**PN gear sectional diagram**

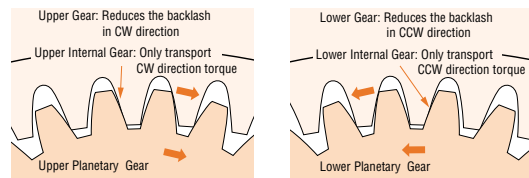

**Relationship between the internal gear and the planetary gear**

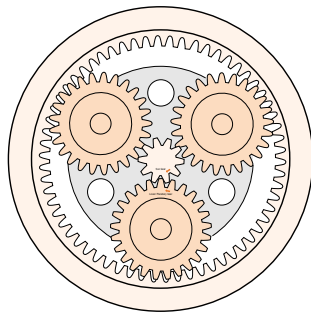

The structure of the PN gear

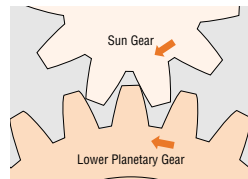
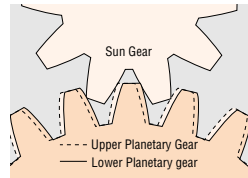
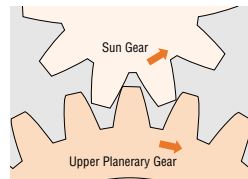

### Angular transmission error 6 minutes

The difference between the theoretical rotation angle of the output shaft and the actual rotation angle is expressed as the angular transmission error. With the **PN** geared types, special gear machining technology is used and major improvements have been made at the part and the assembly levels in order to attain high-precision positioning with an error of 6 arc minutes or less.

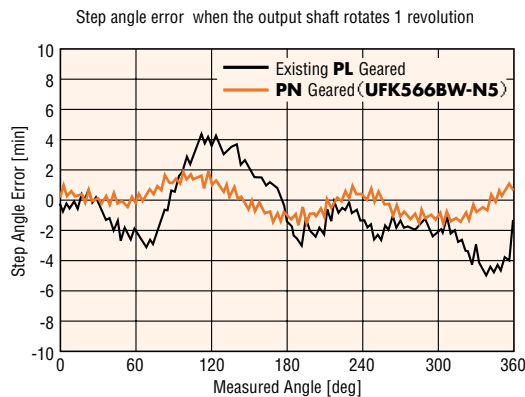

### Low-vibration operation

When a geared motor is used, the motor's low-speed vibration region is avoided and vibration is reduced. Since **PN** gears have backlash of less than 3 arc minutes, further reduction in vibration in the low-speed region is attained.

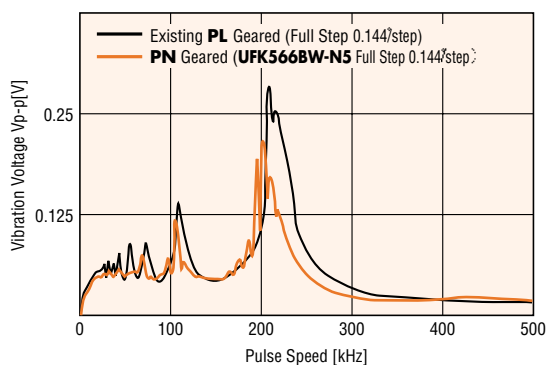

## PRECAUTIONS

When using the **NanoStep. UFK•W** Geared Type, please note the following:

### 1. Do not exceed the maximum permissible torque:

Permissible torque represents the maximum value of the mechanical strength of the gear unit. Be sure to keep the total value of acceleration/deceleration torque and load (friction) torque at the shaft under the permissible torque value. If torque exceeding the permissible torque is applied, the gear unit may fail.

### 2. Do not exceed the permissible speed range:

Do not exceed the maximum output speed of the gearhead indicated in the specifications on page B-136, B-137 and B-142. The speed affects the life of the gearhead. Be sure to use the gear unit below the maximum permissible speed.

### 3. Be careful of backlash in positioning for both forward and reverse directions:

Backlash is the free rotation angle (i.e., play) of the output shaft when the input section of the reduction gear is fixed. The value for each geared type is shown below;

- TH** Geared: Backlash 10 arc minutes, 15 arc minutes, 25 arc minutes or 35 arc minutes depending on frame size and gear ratio
- PN** Geared: Backlash 3 arc minutes maximum

Each geared type of the **NanoStep. UFK•W** provides low backlash with high accuracy in positioning. If there is a problem with backlash in bi-directional positioning, be sure to stop the motor in one direction.

### 4. The direction of gear-shaft rotations differs according to the gear ratio:

When the **TH** geared type is used, the relationship between the rotating direction of the motor shaft and the rotating direction of the gear output shaft varies, depending on the gear ratio used.

Gear ratio	3.6:1, 7.2:1 and 10:1	Same as motor
Gear ratio	20:1 and 30:1	Opposite to motor

When the **PN** geared type is used, the motor and the output shaft of the gear rotate in the same direction with all gear ratios.

# ■ SPECIFICATIONS TH GEARED TYPE



Package Model	Single Shaft	UFK564AW-T3.6	UFK564AW-T7.2	UFK564AW-T10	UFK564AW-T20	UFK564AW-T30
	Double Shaft	UFK564BW-T3.6	UFK564BW-T7.2	UFK564BW-T10	UFK564BW-T20	UFK564BW-T30
Maximum Holding Torque	lb-in (N-m)	10.8 (1.25)	21.6 (2.5)	26 (3)	30.3 (3.5)	34.7 (4)
Rotor Inertia	oz-in <sup>2</sup> (kg-m <sup>2</sup> )	0.96 (175×10 <sup>-7</sup> )				
Rated Current	A/phase	1.4				
Basic Step Angle		0.2°	0.1°	0.072°	0.036°	0.024°
Gear Ratio		3.6:1	7.2:1	10:1	20:1	30:1
Permissible Torque	lb-in (N-m)	10.8 (1.25)	21.6 (2.5)	26 (3)	30.3 (3.5)	34.7 (4)
Permissible Thrust Load	lb. (N)	8.8 (40)				
Permissible Overhung Load	lb. (N)	22 (100)				
Backlash	Arc minute (degree)	35 (0.584°)	15 (0.25°)		10 (0.167°)	
Permissible Speed Range (Gear Output Shaft Speed)	Full Step	0~500r/min	0~250r/min	0~180r/min	0~90r/min	0~60r/min
	Half Step	0~500r/min	0~250r/min	0~180r/min	0~90r/min	0~60r/min
Insulation Class		Class B [266°F (130°C)] Recognized as Class A [221°F (105°C)] by UL and CSA standards.				
Power Source		Single-Phase 100V-115V±15% 50/60Hz 5A				
Output Current	A/phase	1.4				
Excitation Mode		Microstep				
Input Signals	Input Signal Circuit	Photocoupler input, Input resistance 220Ω, Input current 20mA maximum (300Ω, 15mA maximum for pulse signal) Signal voltage Photocoupler ON: +4~+5V, Photocoupler OFF: 0~+0.5V				
	● CW Pulse Signal (Pulse Signal)	CW direction step command pulse signal (Step command signal at 1-pulse input mode) Pulse width: 1μs minimum, Pulse rise/fall: 2μs maximum Motor moves when the photocoupler state changes from ON to OFF.				
	● CCW Pulse Signal (Rotation Direction Signal)	CCW direction step command pulse signal (Rotation direction signal at 1-pulse input mode Photocoupler ON: CW, Photocoupler OFF: CCW) Pulse width: 1μs minimum, Pulse rise/fall: 2μs maximum Motor moves when the photocoupler state changes from ON to OFF.				
	● All Winding Off Signal	When in the "photocoupler ON" state, the current to the motor is cut off and the motor shaft can be rotated manually. When in the "photocoupler OFF" state, the current level set by the RUN switch is supplied to the motor.				
	● Step Angle Select Signal	When in the "photocoupler OFF" state, the step angle set by DATA1 is selected. When in the "photocoupler ON" state, the step angle set by DATA2 is selected. (The step angle can be set to 16 different resolution from 0.72° to 0.00288°.)				
Output Signals	Output Signal Circuit	Photocoupler, Open-Collector Output(Emitter common) External use condition: 24 V DC maximum, 10mA maximum				
	● Excitation Timing Signal	The signal is output every time the excitation sequence returns to the initial stage "0". (Photocoupler: ON) 0.72°/step (Resolution 1): Signal output every 10 pulses 0.072°/step (Resolution 10): Signal output every 100 pulses				
	● Overheat Signal	The signal is output when the internal temperature of the driver rises above approximately 176°F (80°C). (Photocoupler: ON) The motor stops automatically if the "Automatic Current Off" function is ON.				
Functions		Automatic current cutback, All windings off, Pulse input mode selection, Step resolution selection				
Indicators (LED)		Power input, Excitation timing output, Overheat signal output				
Driver Cooling method		Natural Ventilation				
Weight (Mass)	Motor lb. (kg)	2.1 (0.95)				
	Driver lb. (kg)	1.88 (0.85)				
Insulation Resistance	Motor	100MΩ minimum under normal temperature and humidity, when measured by a DC500V megger between the motor coils and the motor casing.				
	Driver	100MΩ minimum under normal temperature and humidity, when measured by a DC500V megger between the following places: ● Power input terminal – Protective earthing terminal ● Motor output terminal – Protective earthing terminal ● Signal input/output terminal – Power input terminal ● Signal input/output terminal – Motor output terminal				
Dielectric Strength	Motor	Sufficient to withstand 1.5kV, 60Hz applied between the motor coils and casing for one minute, under normal temperature and humidity.				
	Driver	Sufficient to withstand the following for one minute, under normal temperature and humidity. ● Power input terminal – Protective earthing terminal AC1.5kV 60Hz ● Motor output terminal – Protective earthing terminal AC1.5kV 60Hz ● Signal input/output terminal – Power input terminal AC3.0kV 60Hz ● Signal input/output terminal – Motor output terminal AC3.0kV 60Hz				
Ambient Temperature Range	Motor	+14°F~+122°F (-10°C~+50°C)				
	Driver	+32°F~+122°F (0°C~+50°C)				

- Maximum holding torque refers to the holding torque at motor standstill when the rated current is supplied to the motor (5-phase excitation). Use this value to compare motor torque performance. When using the motor with the dedicated driver, the driver's "Automatic Current Cutback" function at motor standstill reduces maximum holding torque by approximately 50%.
- The power source input current value represents the maximum current. (The input current varies according to the pulse frequency.)
- Permissible torque is the maximum value of the mechanical strength of the gear unit. Use the product with a total torque (load and acceleration) less than the permissible torque.
- Permissible overhung load indicates the value measured at 0.39 inch (10mm) from the tip of the gear output shaft.
- The direction of rotation of the motor and the gear output shaft are the same for the unit type with gear ratios of 3.6:1, 7.2:1 and 10:1. They are opposite for the 20:1 and 30:1 gear ratio types.

Package Model	Single Shaft	<b>UFK596AW-T3.6</b>	<b>UFK596AW-T7.2</b>	<b>UFK596AW-T10</b>	<b>UFK596AW-T20</b>	<b>UFK596AW-T30</b>
	Double Shaft	<b>UFK596BW-T3.6</b>	<b>UFK596BW-T7.2</b>	<b>UFK596BW-T10</b>	<b>UFK596BW-T20</b>	<b>UFK596BW-T30</b>
Maximum Holding Torque	lb-in (N·m)	39 (4.5)	78.1 (9)	78.1 (9)	104 (12)	104 (12)
Rotor Inertia	oz-in <sup>2</sup> (kg·m <sup>2</sup> )	7.65 (1400×10 <sup>-7</sup> )				
Rated Current	A/phase	1.4				
Basic Step Angle		0.2°	0.1°	0.072°	0.036°	0.024°
Gear Ratio		3.6:1	7.2:1	10:1	20:1	30:1
Permissible Torque	lb-in (N·m)	39 (4.5)	78.1 (9)	78.1 (9)	104 (12)	104 (12)
Permissible Thrust Load	lb. (N)	22 (100)				
Permissible Overhung Load	lb. (N)	66.1 (300)				
Backlash	Arc minute (degree)	25 (0.417°)	15 (0.25°)		10 (0.167°)	
Permissible Speed Range (Gear Output Shaft Speed)	Full Step	0~500r/min	0~250r/min	0~180r/min	0~90r/min	0~60r/min
	Half Step	0~500r/min	0~250r/min	0~180r/min	0~90r/min	0~60r/min
Insulation Class		Class B [266°F (130°C)] Recognized as Class A [221°F (105°C)] by UL and CSA standards.				
Power Source		Single-Phase 100V~115V±15% 50/60Hz 5A				
Output Current	A/phase	1.4				
Excitation Mode		Microstep				
Input Signals	Input Signal Circuit	Photocoupler input, Input resistance 220Ω, Input current 20mA maximum (300Ω, 15mA maximum for pulse signal) Signal voltage Photocoupler ON: +14~+15V, Photocoupler OFF: 0~+10.5V				
	● CW Pulse Signal (Pulse Signal)	CW direction step command pulse signal (Step command signal at 1-pulse input mode) Pulse width: 1μs minimum, Pulse rise/fall: 2μs maximum Motor moves when the photocoupler state changes from ON to OFF.				
	● CCW Pulse Signal (Rotation Direction Signal)	CCW direction step command pulse signal (Rotation direction signal at 1-pulse input mode Photocoupler ON: CW, Photocoupler OFF: CCW) Pulse width: 1μs minimum, Pulse rise/fall: 2μs maximum Motor moves when the photocoupler state changes from ON to OFF.				
	● All Winding Off Signal	When in the "photocoupler ON" state, the current to the motor is cut off and the motor shaft can be rotated manually. When in the "photocoupler OFF" state, the current level set by the RUN switch is supplied to the motor.				
Output Signals	● Step Angle Select Signal	When in the "photocoupler OFF" state, the step angle set by DATA1 is selected. When in the "photocoupler ON" state, the step angle set by DATA2 is selected. (The step angle can be set to 16 different resolution from 0.72° to 0.00288°.)				
	Output Signal Circuit	Photocoupler, Open-Collector Output(Emitter common) External use condition: 24 V DC maximum, 10mA maximum				
	● Excitation Timing Signal	The signal is output every time the excitation sequence returns to the initial stage "0". (Photocoupler: ON) 0.72°/step (Resolution 1): Signal output every 10 pulses 0.072°/step (Resolution 10): Signal output every 100 pulses				
Functions	● Overheat Signal	The signal is output when the internal temperature of the driver rises above approximately 176°F (80°C). (Photocoupler: ON) The motor stops automatically if the "Automatic Current Off" function is ON.				
	Functions	Automatic current cutback, All windings off, Pulse input mode selection, Step resolution selection				
Indicators (LED)		Power input, Excitation timing output, Overheat signal output				
Driver Cooling method		Natural Ventilation				
Weight (Mass)	Motor lb. (kg)	6.29 (2.85)				
	Driver lb. (kg)	1.88 (0.85)				
Insulation Resistance	Motor	100MΩ minimum under normal temperature and humidity, when measured by a DC500V megger between the motor coils and the motor casing.				
	Driver	100MΩ minimum under normal temperature and humidity, when measured by a DC500V megger between the following places: ● Power input terminal – Protective earthing terminal ● Motor output terminal – Protective earthing terminal ● Signal input/output terminal – Power input terminal ● Signal input/output terminal – Motor output terminal				
Dielectric Strength	Motor	Sufficient to withstand 1.5kV, 60Hz applied between the motor coils and casing for one minute, under normal temperature and humidity.				
	Driver	Sufficient to withstand the following for one minute, under normal temperature and humidity. ● Power input terminal – Protective earthing terminal AC1.5kV 60Hz ● Motor output terminal – Protective earthing terminal AC1.5kV 60Hz ● Signal input/output terminal – Power input terminal AC3.0kV 60Hz ● Signal input/output terminal – Motor output terminal AC3.0kV 60Hz				
Ambient Temperature Range	Motor	+14°F~+122°F (-10°C~+50°C)				
	Driver	+32°F~+122°F (0°C~+50°C)				

- Maximum holding torque refers to the holding torque at motor standstill when the rated current is supplied to the motor (5-phase excitation). Use this value to compare motor torque performance. When using the motor with the dedicated driver, the driver's "Automatic Current Cutback" function at motor standstill reduces maximum holding torque by approximately 50%.
- The power source input current value represents the maximum current. (The input current varies according to the pulse frequency.)
- Permissible torque is the maximum value of the mechanical strength of the gear unit. Use the product with a total torque (load and acceleration) less than the permissible torque.
- Permissible overhung load indicates the value measured at 0.39 inch (10mm) from the tip of the gear output shaft.
- The direction of rotation of the motor and the gear output shaft are the same for the unit type with gear ratios of 3.6:1, 7.2:1 and 10:1. They are opposite for the 20:1 and 30:1 gear ratio types.

## ■ SPEED vs. TORQUE CHARACTERISTICS

fs: Maximum Starting Pulse Rate

### UFK564AW-T3.6 UFK564BW-T3.6

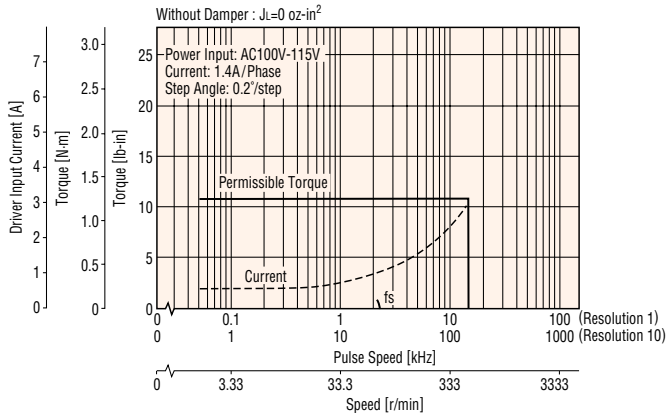

### UFK564AW-T20 UFK564BW-T20

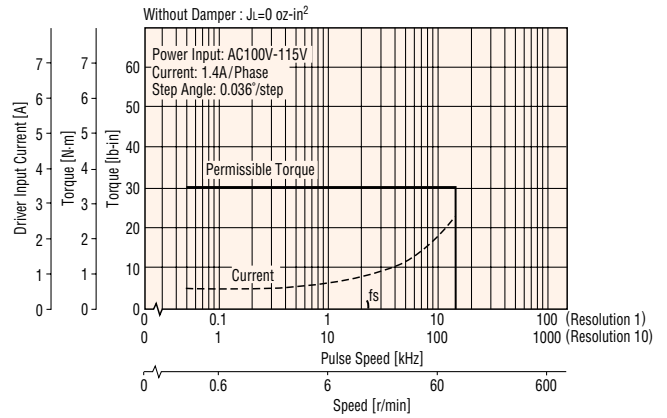

### UFK564AW-T7.2 UFK564BW-T7.2

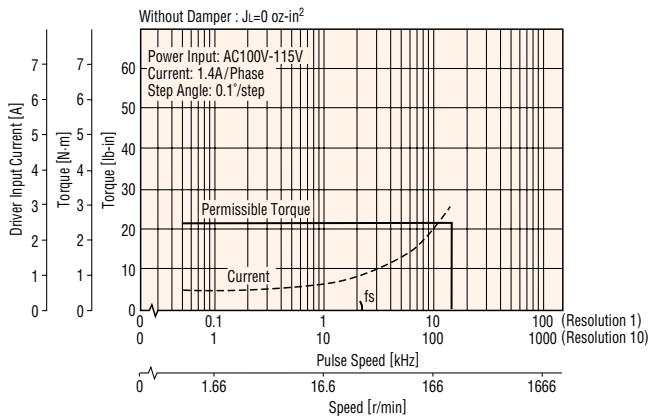

### UFK564AW-T30 UFK564BW-T30

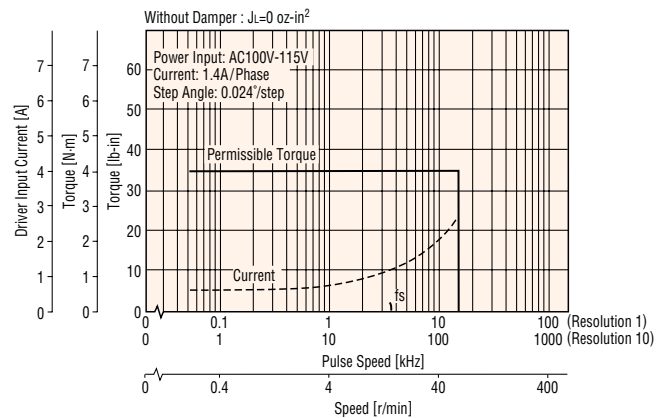

### UFK564AW-T10 UFK564BW-T10

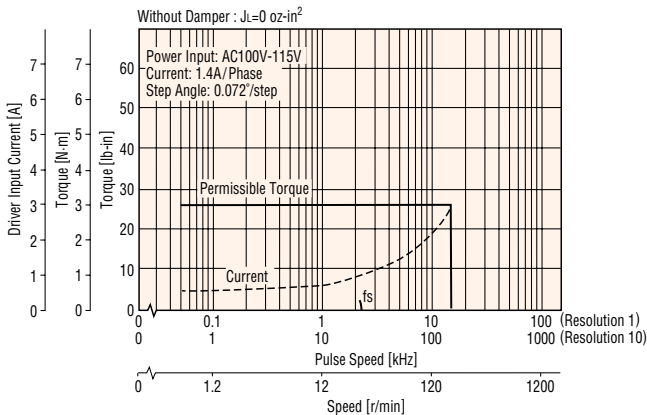

#### Note:

- Pay attention to heat dissipation from the motor and driver. The motor will produce a considerable amount of heat under certain conditions. Be sure to keep the temperature of the motor case under 212°F (100°C). [Under 167°F (75°C) is required to comply with UL or CSA standard.]
- When using the motor with the dedicated driver, the driver's "Automatic Current Cutback" function at motor standstill reduces maximum holding torque by approximately 50%.

**UFK596AW-T3.6**  
**UFK596BW-T3.6**

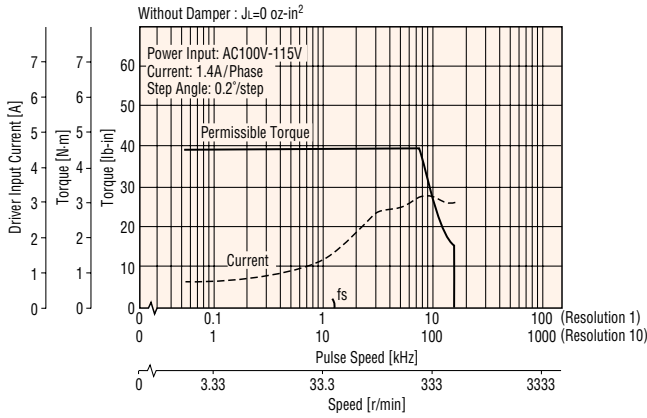

**UFK596AW-T20**  
**UFK596BW-T20**

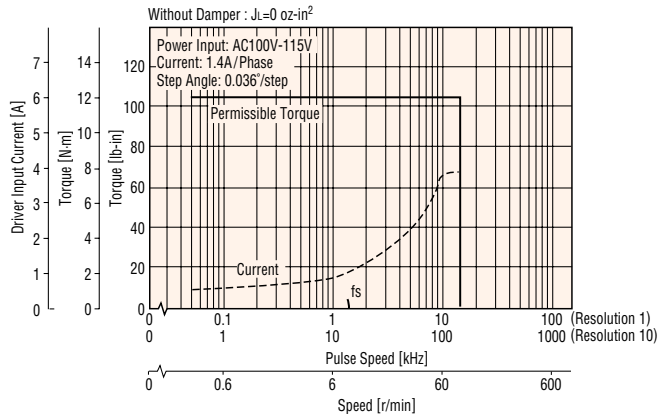

**UFK596AW-T7.2**  
**UFK596BW-T7.2**

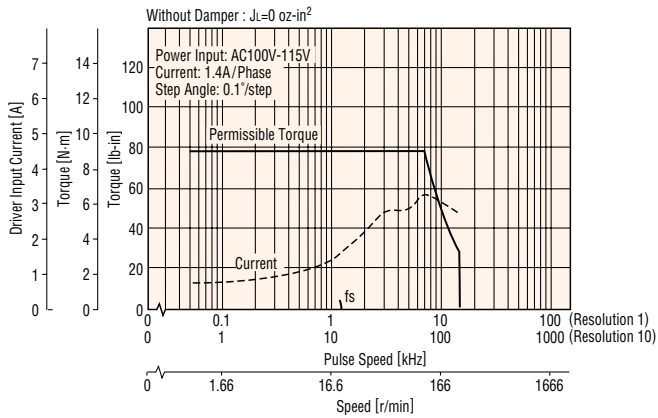

**UFK596AW-T30**  
**UFK596BW-T30**

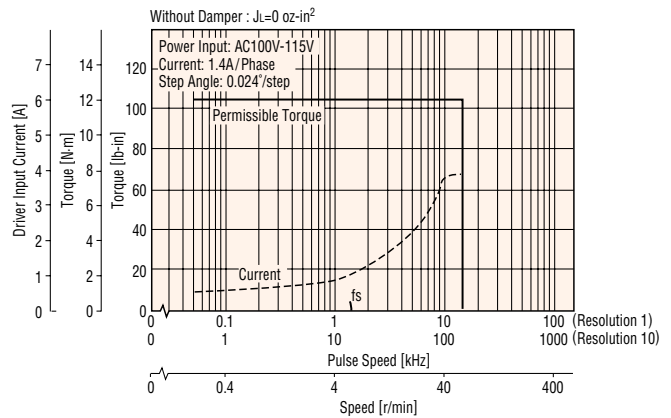

**UFK596AW-T10**  
**UFK596BW-T10**

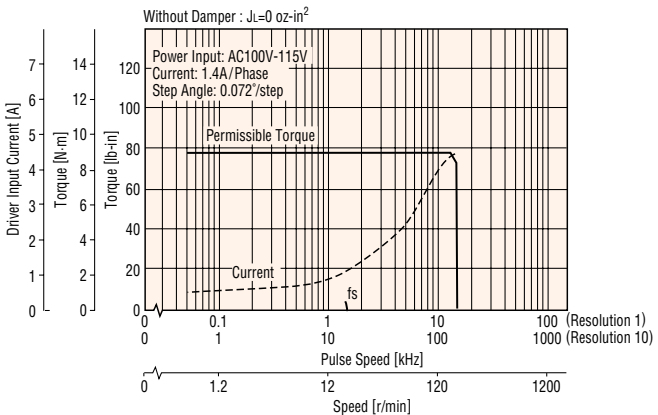

**Note:**

- Pay attention to heat dissipation from the motor and driver. The motor will produce a considerable amount of heat under certain conditions. Be sure to keep the temperature of the motor case under 212°F (100°C). [Under 167°F (75°C) is required to comply with UL or CSA standard.]
- When using the motor with the dedicated driver, the driver's "Automatic Current Cutback" function at motor standstill reduces maximum holding torque by approximately 50%.

## DIMENSIONS scale 1/4, unit = inch (mm)

### Motor

**UFK564AW-T3.6** (Single shaft) Motor Model: PK564AW-T3.6  
**UFK564AW-T7.2** (Single shaft) Motor Model: PK564AW-T7.2  
**UFK564AW-T10** (Single shaft) Motor Model: PK564AW-T10  
**UFK564AW-T20** (Single shaft) Motor Model: PK564AW-T20  
**UFK564AW-T30** (Single shaft) Motor Model: PK564AW-T30  
 Weight 2.1lb. (Mass 0.95kg)

**UFK564BW-T3.6** (Double shaft) Motor Model: PK564BW-T3.6  
**UFK564BW-T7.2** (Double shaft) Motor Model: PK564BW-T7.2  
**UFK564BW-T10** (Double shaft) Motor Model: PK564BW-T10  
**UFK564BW-T20** (Double shaft) Motor Model: PK564BW-T20  
**UFK564BW-T30** (Double shaft) Motor Model: PK564BW-T30

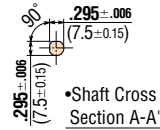
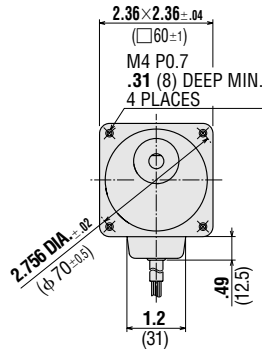
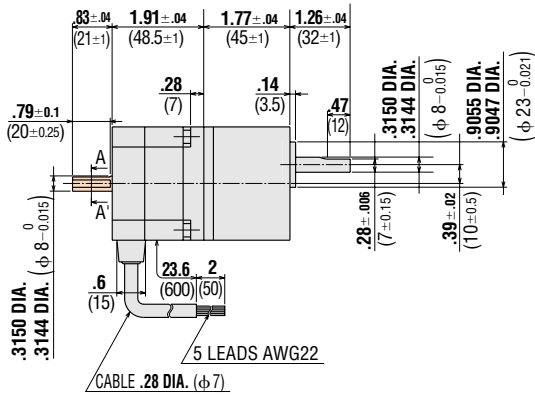

•Screws (Included)  
 4-M4 P0.7 length .71 (18)

**UFK596AW-T3.6** (Single shaft) Motor Model: PK596AW-T3.6  
**UFK596AW-T7.2** (Single shaft) Motor Model: PK596AW-T7.2  
**UFK596AW-T10** (Single shaft) Motor Model: PK596AW1-T10  
**UFK596AW-T20** (Single shaft) Motor Model: PK596AW1-T20  
**UFK596AW-T30** (Single shaft) Motor Model: PK596AW1-T30  
 Weight 6.29lb. (Mass 2.85kg)

**UFK596BW-T3.6** (Double shaft) Motor Model: PK596BW-T3.6  
**UFK596BW-T7.2** (Double shaft) Motor Model: PK596BW-T7.2  
**UFK596BW-T10** (Double shaft) Motor Model: PK596BW1-T10  
**UFK596BW-T20** (Double shaft) Motor Model: PK596BW1-T20  
**UFK596BW-T30** (Double shaft) Motor Model: PK596BW1-T30

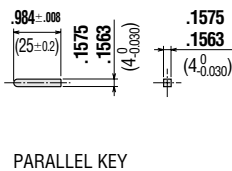
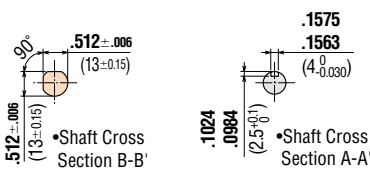
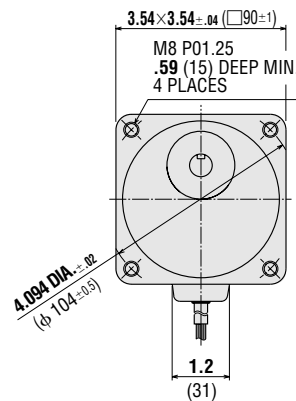
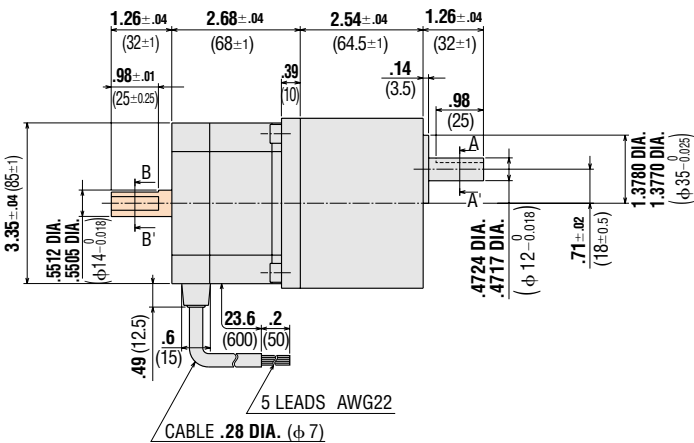

•Screws (Included)  
 4-M8 P1.25 length .71 (18)

See page B-36 for information on motor installation.

•These external appearance drawings are for double shaft models. For single shaft, ignore the colored areas.

● **Driver**

Driver Model: DFU1514W Weight 1.88lb. (Mass 0.85kg)

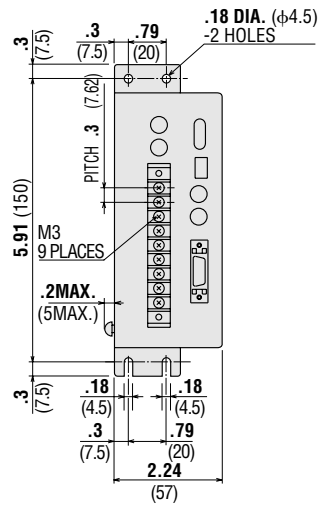
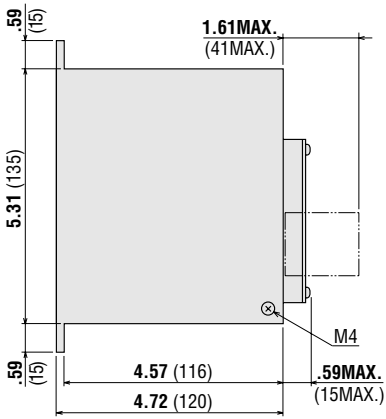
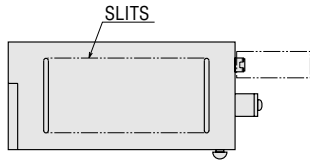

- I/O Signal Connector (Included)  
 Connector: 54306-2011 (MOLEX)  
 Connector Cover: 54331-1201 (MOLEX)

See page B-38 for information on driver installation.



# SPECIFICATIONS PN GEARED TYPE



Package Model		Single Shaft	UFK566AW-N5	UFK566AW-N7.2	UFK566AW-N10	UFK564AW-N25	UFK564AW-N36	UFK564AW-N50
		Double Shaft	UFK566BW-N5	UFK566BW-N7.2	UFK566BW-N10	UFK564BW-N25	UFK564BW-N36	UFK564BW-N50
Maximum Holding Torque	lb-in (N-m)	30.3 (3.5)				52 (6)		
Rotor Inertia	oz·in <sup>2</sup> (kg·m <sup>2</sup> )	1.53 (280×10 <sup>-7</sup> )				0.95 (175×10 <sup>-7</sup> )		
Rated Current	A/phase	1.4						
Basic Step Angle		0.144°	0.1°	0.072°	0.0288°	0.02°	0.0144°	
Gear Ratio		5:1	7.2:1	10:1	25:1	36:1	50:1	
Permissible Torque	lb-in (N-m)	30.3 (3.5)				52 (6)		
Permissible Thrust Load	lb. (N)	22 (100)						
Permissible Overhung Load	lb. (N)	55 (250)	60 (300)	60 (300)	88.1 (400)			
Backlash	Arc minute (degree)	3 (0.05°)						
Permissible Speed Range (Gear Output Shaft Speed)	Full Step	0~360r/min	0~250r/min	0~180r/min	0~72r/min	0~50r/min	0~36r/min	
	Half Step	0~360r/min	0~250r/min	0~180r/min	0~72r/min	0~50r/min	0~36r/min	
Insulation Class		Class B [266°F (130°C)] Recognized as Class A [221°F (105°C)] by UL and CSA standards.						
Power Source		Single-Phase 100V - 115V±15% 50/60Hz 5A						
Output Current	A/phase	1.4						
Excitation Mode		Microstep						
Input Signals	Input Signal Circuit	Photocoupler input, Input resistance 220Ω, Input current 20mA maximum (300Ω, 15mA maximum for pulse signal) Signal voltage Photocoupler ON: +4~+5V, Photocoupler OFF: 0~+0.5V						
	● CW Pulse Signal (Pulse Signal)	CW direction step command pulse signal (Step command signal at 1-pulse input mode) Pulse width: 1μs minimum, Pulse rise/fall: 2μs maximum Motor moves when the photocoupler state changes from ON to OFF.						
	● CCW Pulse Signal (Rotation Direction Signal)	CCW direction step command pulse signal (Rotation direction signal at 1-pulse input mode Photocoupler ON: CW, Photocoupler OFF: CCW) Pulse width: 1μs minimum, Pulse rise/fall: 2μs maximum Motor moves when the photocoupler state changes from ON to OFF.						
	● All Winding Off Signal	When in the "photocoupler ON" state, the current to the motor is cut off and the motor shaft can be rotated manually. When in the "photocoupler OFF" state, the current level set by the RUN switch is supplied to the motor.						
	● Step Angle Select Signal	When in the "photocoupler OFF" state, the step angle set by DATA1 is selected. When in the "photocoupler ON" state, the step angle set by DATA2 is selected. (The step angle can be set to 16 different resolution from 0.72° to 0.00288°.)						
Output Signals	Output Signal Circuit	Photocoupler, Open-Collector Output(Emitter common) External use condition: 24 V DC maximum, 10mA maximum						
	● Excitation Timing Signal	The signal is output every time the excitation sequence returns to the initial stage "0". (Photocoupler: ON) 0.72°/step (Resolution 1): Signal output every 10 pulses 0.072°/step (Resolution 10): Signal output every 100 pulses						
	● Overheat Signal	The signal is output when the internal temperature of the driver rises above approximately 176°F (80°C). (Photocoupler: ON) The motor stops automatically if the "Automatic Current Off" function is ON.						
Functions		Automatic current cutback, All windings off, Pulse input mode selection, Step resolution selection						
Indicators (LED)		Power input, Excitation timing output, Overheat signal output						
Driver Cooling method		Natural Ventilation						
Weight (Mass)	Motor lb. (kg)	3.31 (1.5)				3.31 (1.5)		
	Driver lb. (kg)	1.88 (0.85)						
Insulation Resistance	Motor	100MΩ minimum under normal temperature and humidity, when measured by a DC500V megger between the motor coils and the motor casing.						
	Driver	100MΩ minimum under normal temperature and humidity, when measured by a DC500V megger between the following places: ● Power input terminal – Protective earthing terminal ● Motor output terminal – Protective earthing terminal ● Signal input/output terminal – Power input terminal ● Signal input/output terminal – Motor output terminal						
Dielectric Strength	Motor	Sufficient to withstand 1.5kV, 60Hz applied between the motor coils and casing for one minute, under normal temperature and humidity.						
	Driver	Sufficient to withstand the following for one minute, under normal temperature and humidity. ● Power input terminal – Protective earthing terminal AC1.5kV 60Hz ● Motor output terminal – Protective earthing terminal AC1.5kV 60Hz ● Signal input/output terminal – Power input terminal AC3.0kV 60Hz ● Signal input/output terminal – Motor output terminal AC3.0kV 60Hz						
Ambient Temperature Range	Motor	+14°F~+122°F (-10°C~+50°C)						
	Driver	+32°F~+122°F (0°C~+50°C)						

- Maximum holding torque refers to the holding torque at motor standstill when the rated current is supplied to the motor (5-phase excitation). Use this value to compare motor torque performance. When using the motor with the dedicated driver, the driver's "Automatic Current Cutback" function at motor standstill reduces maximum holding torque by approximately 50%.
- The power source input current value represents the maximum current. (The input current varies according to the pulse frequency.)
- Permissible torque is the maximum value of the mechanical strength of the gear unit. Use the product with a total torque (load and acceleration) less than the permissible torque.
- Permissible overhung load indicates the value measured at 0.39 inch (10mm) from the tip of the gear output shaft.

# SPEED vs. TORQUE CHARACTERISTICS

fs: Maximum Starting Pulse Rate

## UFK566AW-N5 UFK566BW-N5

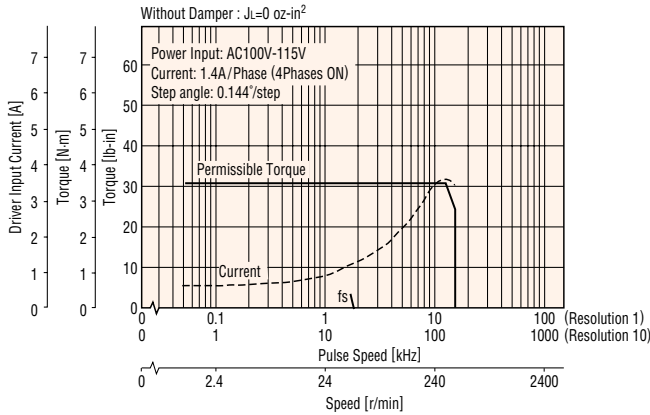

## UFK564AW-N25 UFK564BW-N25

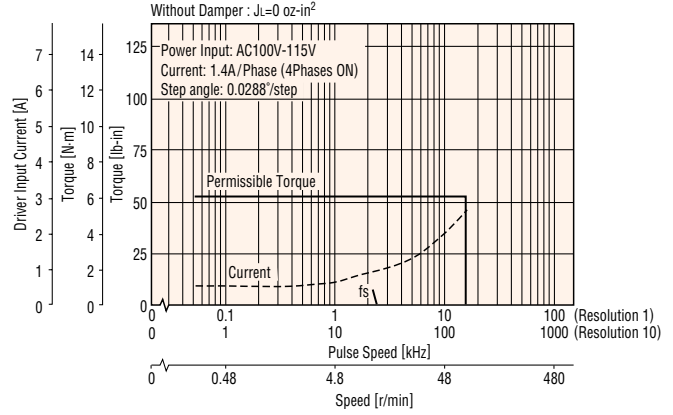

## UFK566AW-N7.2 UFK566BW-N7.2

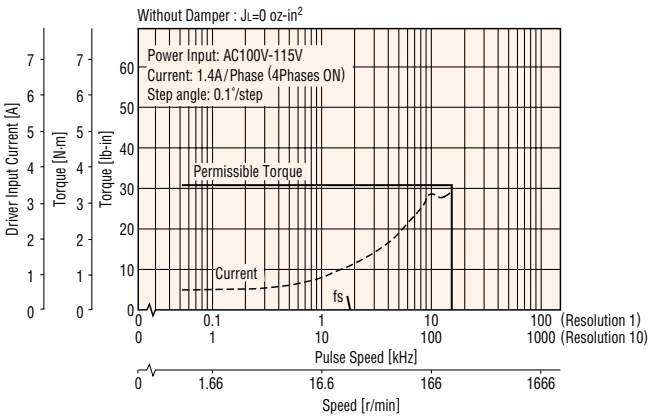

## UFK564AW-N36 UFK564BW-N36

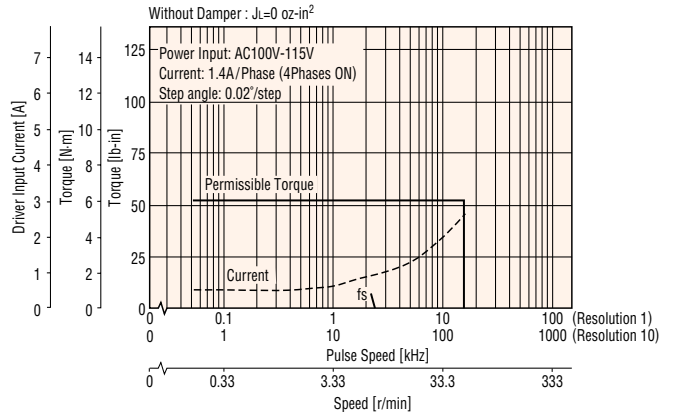

## UFK566AW-N10 UFK566BW-N10

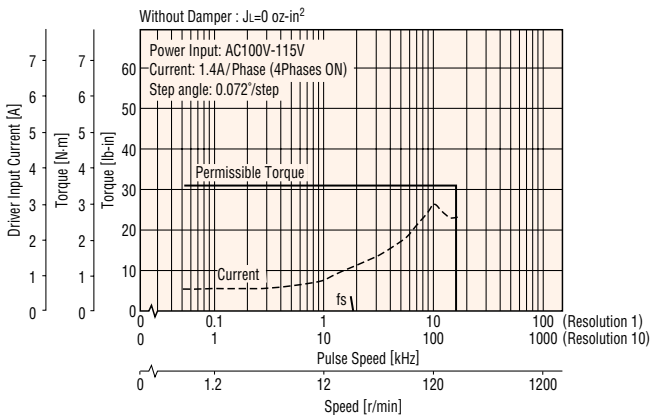

## UFK564AW-N50 UFK564BW-N50

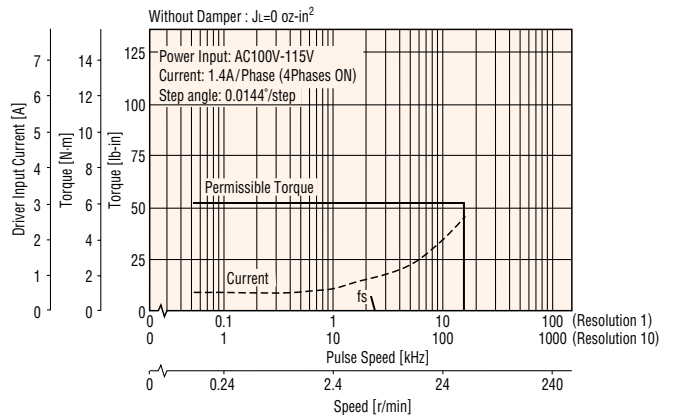

### Note:

- Pay attention to heat dissipation from the motor and driver. The motor will produce a considerable amount of heat under certain conditions. Be sure to keep the temperature of the motor case under 212°F (100°C). [Under 167°F (75°C) is required to comply with UL or CSA standard.]
- When using the motor with the dedicated driver, the driver's "Automatic Current Cutback" function at motor standstill reduces maximum holding torque by approximately 50%.

## DIMENSIONS scale 1/4, unit = inch (mm)

### Motor

<b>UFK566AW-N5</b>	(Single shaft)	Motor Model: PK566AW-N5
<b>UFK566BW-N5</b>	(Double shaft)	Motor Model: PK566BW-N5
<b>UFK566AW-N7.2</b>	(Single shaft)	Motor Model: PK566AW-N7.2
<b>UFK566BW-N7.2</b>	(Double shaft)	Motor Model: PK566BW-N7.2
<b>UFK566AW-N10</b>	(Single shaft)	Motor Model: PK566AW-N10
<b>UFK566BW-N10</b>	(Double shaft)	Motor Model: PK566BW-N10

Weight 3.31lb. (Mass 1.5kg)

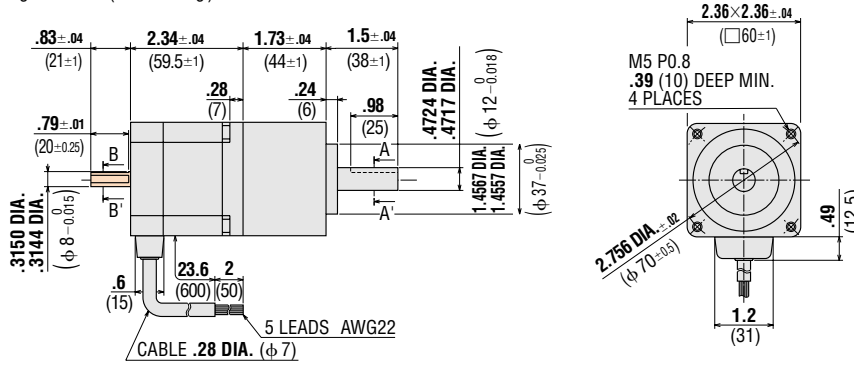

- Screws (Included)  
4-M5 P0.8 length.63 (16)

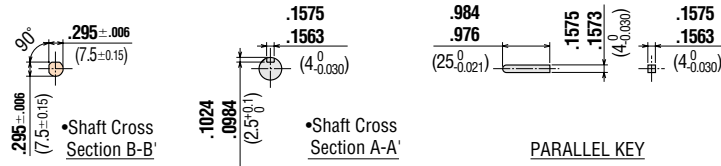

<b>UFK564AW-N25</b>	(Single shaft)	Motor Model: PK564AW-N25
<b>UFK564BW-N25</b>	(Double shaft)	Motor Model: PK564BW-N25
<b>UFK564AW-N36</b>	(Single shaft)	Motor Model: PK564AW-N36
<b>UFK564BW-N36</b>	(Double shaft)	Motor Model: PK564BW-N36
<b>UFK564AW-N50</b>	(Single shaft)	Motor Model: PK564AW-N50
<b>UFK564BW-N50</b>	(Double shaft)	Motor Model: PK564BW-N50

Weight 3.31lb. (Mass 1.5kg)

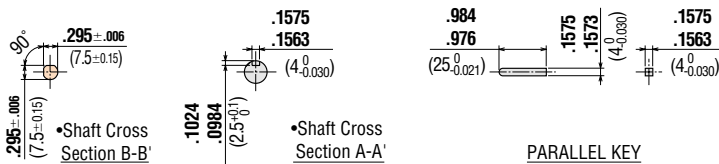
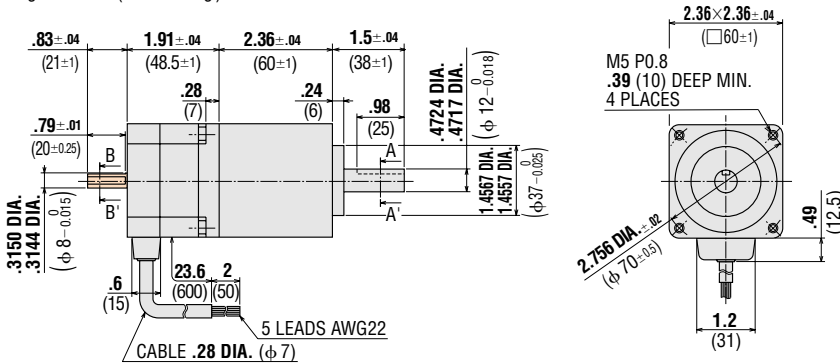

- Screws (Included)  
4-M5 P0.8 length.63 (16)

•These external appearance drawings are for double shaft models.  
For single shaft, ignore the colored areas.

See page B-36 for information on motor installation.

● **Driver**

Driver Model: DFU1514W Weight 1.88lb. (Mass 0.85kg)

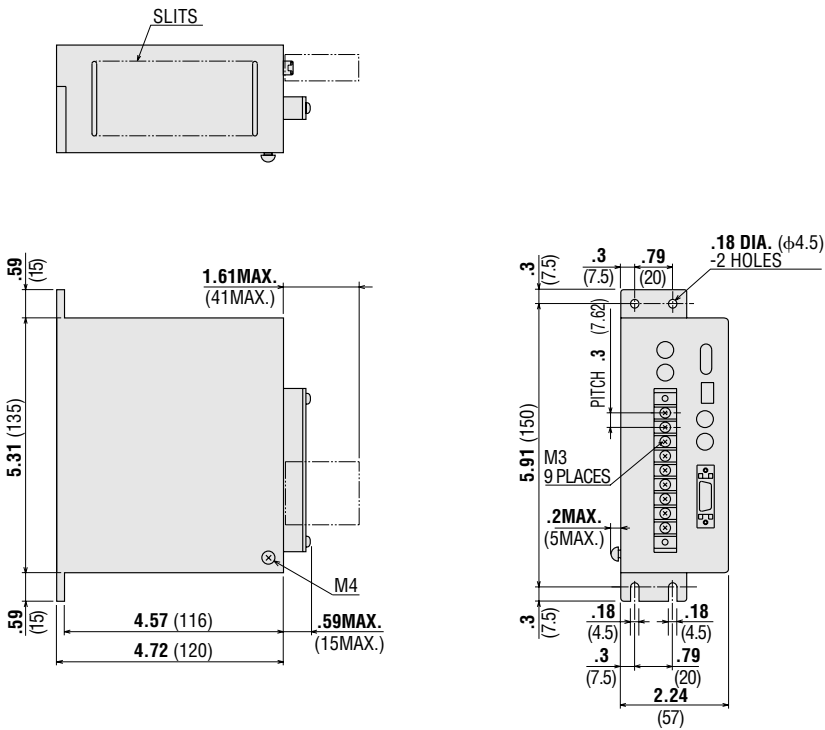

- I/O Signal Connector (Included)  
Connector: 54306-2011 (MOLEX)  
Connector Cover: 54331-1201 (MOLEX)

See page B-38 for information on driver installation.

■ **LIST OF MOTOR AND DRIVER COMBINATIONS**

Type	Package Model	Stepping Motor		Driver
		Model	Current A/phase	Model
Standard	<b>UFK564□W</b> <b>UFK566□W</b> <b>UFK569□W</b> <b>UFK596□W</b> <b>UFK599□W</b> <b>UFK5913□W</b>	PK564□W PK566□W PK569□W PK596□W PK599□W PK5913□W	1.4	DFU1514W
TH Geared	<b>UFK564□W-T3.6</b> <b>UFK564□W-T7.2</b> <b>UFK564□W-T10</b> <b>UFK564□W-T20</b> <b>UFK564□W-T30</b> <b>UFK596□W-T3.6</b> <b>UFK596□W-T7.2</b> <b>UFK596□W-T10</b> <b>UFK596□W-T20</b> <b>UFK596□W-T30</b>	PK564□W-T3.6 PK564□W-T7.2 PK564□W-T10 PK564□W-T20 PK564□W-T30 PK596□W-T3.6 PK596□W-T7.2 PK596□W-T10 PK596□W1-T10 PK596□W1-T20 PK596□W1-T30	1.4	DFU1514W
PN Geared	<b>UFK566□W-N5</b> <b>UFK566□W-N7.2</b> <b>UFK566□W-N10</b> <b>UFK564□W-N25</b> <b>UFK564□W-N36</b> <b>UFK564□W-N50</b>	PK566□W-N5 PK566□W-N7.2 PK566□W-N10 PK564□W-N25 PK564□W-N36 PK564□W-N50	1.4	DFU1514W

Enter **A** (single shaft) or **B** (double shaft) in the □ within the model numbers.

## ■ SETTING THE STEP ANGLE

With the **NanoStep UFK•W**, the motor speed and step distance can be changed without changing the input pulse frequency by switching the step angle setting switch.

The step angle is set with step angle setting switches DATA1 and DATA2. DATA1 and DATA2 each have 16 settings from which one step angle each can be selected. The step angles that can be set are shown in the table on the right.

### Setting method

DATA1 and DATA2 are set to the scale corresponding to the step angle selected for each. The step angle is changed with the step angle switching signals.

High level: The step angle set with DATA1 is selected.

Low level: The step angle set with DATA2 is selected.

### Example

Using the **PN** geared type **UFK564AW-N36** and setting DATA1 to 0.001°/step and DATA2 to 0.01°/step:

- The scale for DATA1 is set at 7.
- The scale for DATA2 is set at 1.
- When the step angle switching signal input is set to high level, the motor rotates with the 0.001°/step step angle set with DATA1.
- When the step angle switching signal input is set to low level, the motor rotates with the 0.01°/step step angle set with DATA2.

### Note:

- You should change the step angle setting input when the pulse signals are stopped so the motor will not deviate from its correct position. If you change the step angle setting input during pulse input, the motor may deviate from its correct position.
- Changing the step angle does not change the torque generated on the motor output shaft for the same rotation rate.

## ● Standard Type

Resolution Select Switch Common to DATA 1 and DATA 2	Resolution	Step Angle
0	1	0.72°
1	2	0.36°
2	2.5	0.288°
3	4	0.18°
4	5	0.144°
5	8	0.09°
6	10	0.072°
7	20	0.036°
8	25	0.0288°
9	40	0.018°
A	50	0.0144°
B	80	0.009°
C	100	0.0072°
D	125	0.00576°
E	200	0.0036°
F	250	0.00288°

## ● TH Geared Type

Resolution Select Switch Common to DATA 1 and DATA 2	Resolution	Step Angle of Output Shaft				
		Gear Ratio	Gear Ratio	Gear Ratio	Gear Ratio	Gear Ratio
		3.6: 1	7.2: 1	10: 1	20: 1	30: 1
0	1	0.2°	0.1°	0.072°	0.036°	0.024°
1	2	0.1°	0.05°	0.036°	0.018°	0.012°
2	2.5	0.08°	0.04°	0.0288°	0.0144°	0.0096°
3	4	0.05°	0.025°	0.018°	0.009°	0.0006°
4	5	0.04°	0.02°	0.0144°	0.0072°	0.0048°
5	8	0.025°	0.0125°	0.009°	0.0045°	0.0003°
6	10	0.02°	0.01°	0.0072°	0.0036°	0.0024°
7	20	0.01°	0.005°	0.0036°	0.0018°	0.0012°
8	25	0.008°	0.004°	0.00288°	0.00144°	0.00086°
9	40	0.005°	0.0025°	0.00188°	0.0009°	0.0006°
A	50	0.004°	0.002°	0.00144°	0.00072°	0.00048°
B	80	0.0025°	0.00125°	0.0009°	0.00045°	0.0003°
C	100	0.002°	0.001°	0.00072°	0.00036°	0.00024°
D	125	0.0016°	0.0008°	0.000576°	0.000288°	0.000192°
E	200	0.001°	0.0005°	0.00036°	0.00018°	0.00012°
F	250	0.0008°	0.0004°	0.000288°	0.000144°	0.000096°

## ● PN Geared Type

Resolution Select Switch Common to DATA 1 and DATA 2	Resolution	Step Angle of Output Shaft					
		Gear Ratio	Gear Ratio	Gear Ratio	Gear Ratio	Gear Ratio	Gear Ratio
		5: 1	7.2: 1	10: 1	25: 1	36: 1	50: 1
0	1	0.144°	0.1°	0.072°	0.0288°	0.02°	0.0144°
1	2	0.072°	0.05°	0.036°	0.0144°	0.01°	0.0072°
2	2.5	0.0576°	0.04°	0.0288°	0.01152°	0.008°	0.00576°
3	4	0.036°	0.025°	0.018°	0.0072°	0.005°	0.0036°
4	5	0.0288°	0.02°	0.0144°	0.00576°	0.004°	0.00288°
5	8	0.018°	0.0125°	0.009°	0.0036°	0.0025°	0.0018°
6	10	0.0144°	0.01°	0.0072°	0.00288°	0.002°	0.00144°
7	20	0.0072°	0.005°	0.0036°	0.00144°	0.001°	0.00072°
8	25	0.00576°	0.004°	0.00288°	0.001152°	0.0008°	0.000576°
9	40	0.0036°	0.0025°	0.0018°	0.00072°	0.0005°	0.00036°
A	50	0.00288°	0.002°	0.00144°	0.000576°	0.0004°	0.000288°
B	80	0.0018°	0.00125°	0.0009°	0.00036°	0.00025°	0.00018°
C	100	0.00144°	0.001°	0.00072°	0.000288°	0.0002°	0.000144°
D	125	0.001152°	0.0008°	0.000576°	0.0002304°	0.00016°	0.0001152°
E	200	0.00072°	0.0005°	0.00036°	0.000144°	0.0001°	0.000072°
F	250	0.000576°	0.0004°	0.000288°	0.0001152°	0.00008°	0.0000576°

## ■ WIRING DIAGRAM

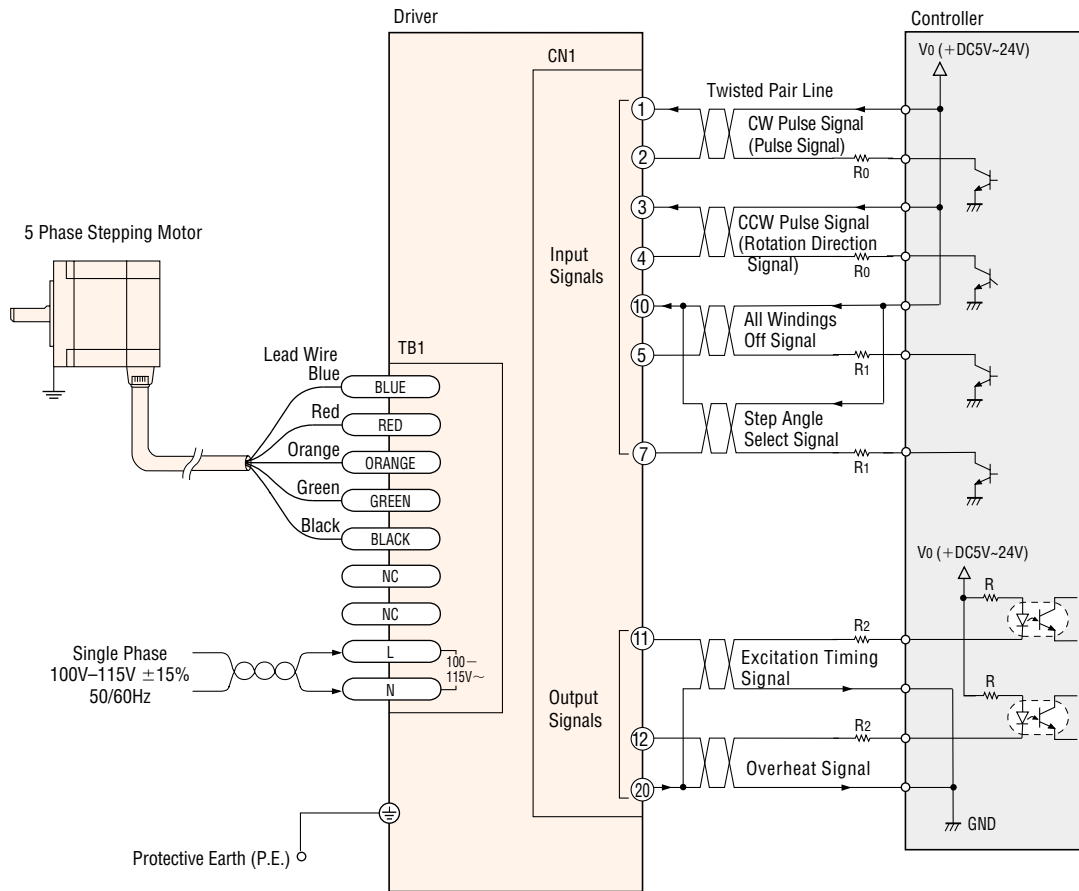

### ■ Power Supply

Use a power supply that can supply sufficient input current.

When power supply capacity is insufficient, a decrease in motor output can cause the following malfunctions:

- Motor does not rotate properly at high-speed (insufficient torque)
- Motor startup and stopping is slow.

#### Note:

- Keep the voltage  $V_0$  between DC5V and DC24V.

When they are equal to DC5V, the external resistances  $R_0$ ,  $R_1$  and  $R_2$  are not necessary.

When they are above DC5V, connect  $R_0$  to keep the current below 15mA, and connect  $R_1$  to keep the current below 20mA, and connect  $R_2$  to keep the current below 10mA.

- Use twisted-pair wire of  $3 \times 10^{-4} \text{ in}^2$  ( $0.2 \text{ mm}^2$ ) or thicker and 6.6 feet (2m) or less in length for the signal line.
- Use wire  $7.8 \times 10^{-4} \text{ in}^2$  ( $0.5 \text{ mm}^2$ ) or thicker for motor lines (when extended) and power supply lines, and use  $1.2 \times 10^{-3} \text{ in}^2$  ( $0.75 \text{ mm}^2$ ) or thicker for the wire for the protective earthing line.
- Use spot grounding for the grounding of the driver and external controller.
- Signal lines should be kept at least 3.94 inch (10cm) away from power lines (power supply lines and motor lines). Do not bind the signal line and power line together.

\* Use open collector transistors (sink type) for the signal output sections of the controller.

#### ⚠ Caution

The driver incorporates double-pole/neutral fusing for the power input. If the driver POWER LED is off, it is possible that only the neutral fuse is tripped. High voltage supplied on the hot side may cause electric shock. Turn the power off immediately and request service.

## DESCRIPTION OF INPUT/OUTPUT SIGNALS

### 1. Pulse Input

#### Input circuit and sample connection

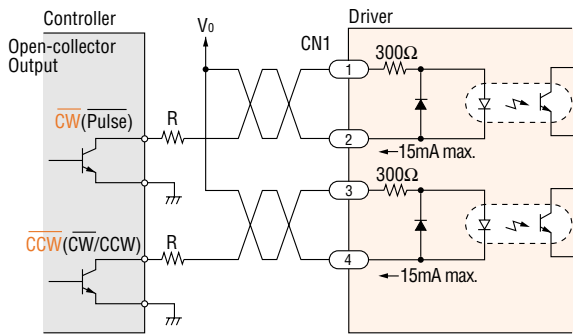

Keep the voltage between DC 5V and DC 24V. When voltage is equal to DC 5V, external resistance (R) is not necessary. When voltage is above DC 5V, connect external resistance (R) and keep the input current below 15mA.

#### 1. 1-Pulse Input Mode

##### Pulse Signal

"Pulse" signal is input to the pulse signal terminal. When the photocoupler state changes from "ON" to "OFF", the motor rotates one step. The direction of rotation is determined by the following rotation direction signal.

##### Rotation Direction Signal

The "Rotation Direction" signal is input to the rotation direction signal input terminal. A "photocoupler ON" signal input commands a clockwise direction rotation. A "photocoupler OFF" signal input commands a counterclockwise direction rotation.

#### 2. 2-Pulse Input Mode

##### CW Pulse Signal

When the photocoupler state changes from "ON" to "OFF", the motor rotates one step in the clockwise direction.

##### CCW Pulse Signal

When the photocoupler state changes from "ON" to "OFF", the motor rotates one step in the counterclockwise direction.

CW and CCW refer to clockwise and counterclockwise direction respectively, from a reference point of facing the motor output shaft.

### Pulse Signal Characteristics

#### Input Pulse characteristics

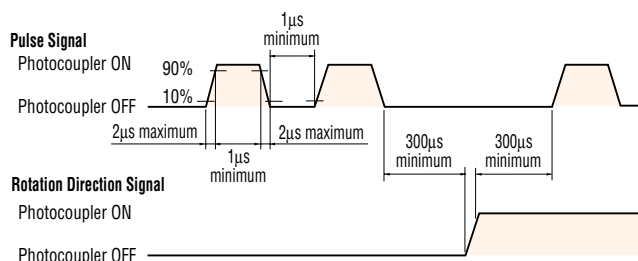

The shaded area indicates when the photocoupler is ON. The motor moves when the photocoupler state changes from ON to OFF as indicated by the arrow.

- The pulse voltage is 4~5V in the "photocoupler ON" state, and 0~0.5V in the "photocoupler OFF" state.
- Input pulse signals should have a pulse width over 1μs, pulse rise/fall below 2μs, and a pulse duty below 50%.
- Keep the pulse signal at "photocoupler OFF" when no pulse is being input.
- The minimum interval time when changing rotation direction is 10μs. This value varies greatly depending on the motor type, pulse frequency and load inertia. It may be necessary to increase this time interval.
- In 1-pulse input mode, leave the pulse signal at rest ("photocoupler OFF") when changing rotation directions.

### 2. A.W.OFF (All Windings Off) Input

#### Input circuit and sample connection

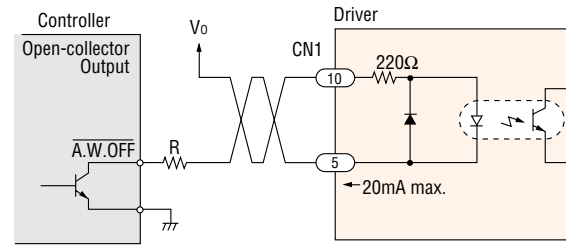

Keep the voltage between DC 5V and DC 24V. When voltage is equal to DC 5V, external resistance (R) is not necessary. When voltage is above DC 5V, connect external resistance (R) and keep the input current below 20mA.

When the "All Windings Off" signal is in the "photocoupler ON" state, the current to the motor is cut off and motor torque is reduced to zero. The motor output shaft can then be rotated freely by hand.

When the "All Windings Off" signal is in the "photocoupler OFF" state, the motor holding torque is proportional to the current set by the current adjustment rotary switches. During motor operation, be sure to keep the signal in the "photocoupler OFF" state.

This signal is used when moving the motor by external force or manual home position is desired. If this function is not needed, it is not necessary to connect this terminal.

Switching the "All Windings Off" signal from "photocoupler ON" to "photocoupler OFF" does not alter the excitation sequence.

When the motor shaft is manually adjusted with the "All Windings Off" signal input, the shaft will shift up to  $\pm 3.6^\circ$  from the position set after the "All Windings Off" signal is released.

### Manual Setting of the Home Position

Input the "All Windings Off" signal, set the motor to the desired position, then release the "All Windings Off" signal.

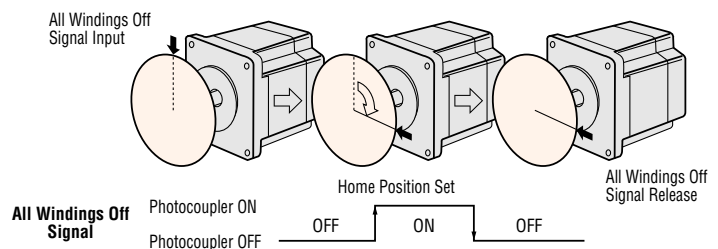

### 3. C/S (Step Angle Switching) Input

#### Input circuit and sample connection

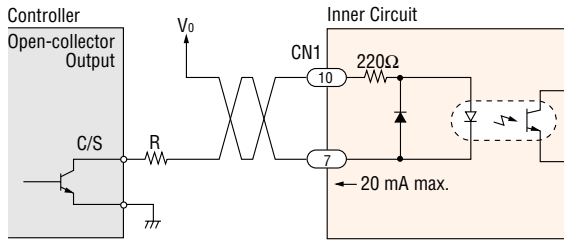

Keep the voltage between DC 5V and DC 24V.  
When voltage is equal to DC 5V, external resistance (R) is not necessary. When voltage is above DC 5V, connect external resistance (R) and keep the input current below 20mA.

When the "Step Angle Select" signal is in the "photocoupler OFF" state, the step angle set by step resolution select switch DATA1 is selected, and when the "Step Angle Select" signal is in the "photocoupler ON" state, the step angle set by step resolution select switch DATA2 is selected.

This signal can be used to change the motor speed or amount of rotation without altering the input pulses.

**Note:** Input the "Step Angle Select" signal when the driver power is off, or when pulse signals are not being input while the excitation timing signal output LED is ON. If the "Step Angle Select" signal is input at other times, the excitation timing signal output and excitation timing LED may not function properly.

### 4. TIM (Excitation Timing) Output

#### Output Circuit and Sample Connection

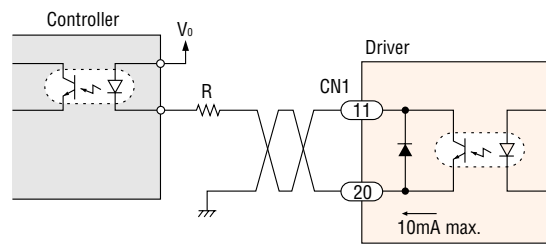

Keep the voltage between DC 5V and DC 24V.  
Keep the current below 10mA. If the current exceeds 10mA, connect external resistance (R).

The "Excitation Timing" signal is output to indicate when the motor excitation (current flowing through the winding) is in the initial stage (step "0" at power up).

The "Excitation Timing" signal can be used to increase the accuracy of home position detection by setting the mechanical home position of your equipment (for example, a photo-sensor) to coincide with the excitation sequence initial stage (step "0").

The motor excitation stage changes simultaneously with pulse input, and returns to the initial stage for each 7.2° rotation of the motor output shaft. When power is turned ON, the excitation sequence is reset to step "0".

The TIM LED lights when the "Excitation Timing" signal is output. While the motor is rotating, the LED will turn ON and OFF at a high speed and will appear to be continuously lit.

The "Excitation Timing" signal is output once for each number of pulses equivalent to 7.2° divided by the step angle setting.

Example: At a step angle setting of 0.72°/step (Division of 1): The signal is output once every 10 pulses

At a step angle setting of 0.072°/step (Division of 10): The signal is output once every 100 pulses

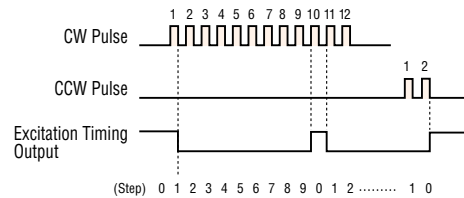

When using the "Excitation Timing" signal, set the number of input pulses and the step angle in combinations which allow the motor shaft to stop at positions which are multiples of 7.2°.

When using the "Step Angle Select" signal to change the step angle, be aware that depending on the number of pulses and step angle setting, there are conditions such as those shown below, in which the "Excitation Timing" signal will not be output.

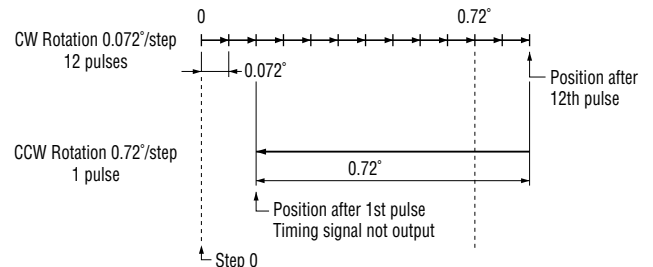



## 5. O. HEAT (Overheat) Output

### ■ Output Circuit and Sample connection

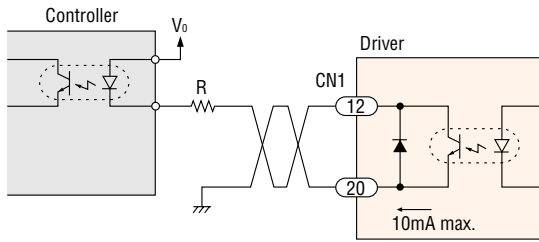

Keep the voltage between DC 5V and DC 24V.  
Keep the current below 10mA. If the current exceeds 10mA, connect external resistance (R).

The "Overheat" signal is output to protect the driver from heat damage if the internal temperature of the driver rises above 176°F (80°C).

When connected as shown in the example connection, the signal will be "photocoupler OFF" during normal conditions, and "photocoupler ON" when the temperature exceeds above 176°F (80°C).

When the "Overheat" signal is output, turn the driver power OFF, then adjust the operating conditions (ambient temperature, driver/controller settings), or use a fan etc. to cool the driver. After taking appropriate measures, turn the power ON. Turning the power ON will reset the "Overheat" signal and release the "Automatic Current Off" condition.

The O.H. LED lights when the "Overheat" signal is output.



## Artisan Technology Group is your source for quality new and certified-used/pre-owned equipment

- FAST SHIPPING AND DELIVERY
- TENS OF THOUSANDS OF IN-STOCK ITEMS
- EQUIPMENT DEMOS
- HUNDREDS OF MANUFACTURERS SUPPORTED
- LEASING/MONTHLY RENTALS
- ITAR CERTIFIED SECURE ASSET SOLUTIONS

### SERVICE CENTER REPAIRS

Experienced engineers and technicians on staff at our full-service, in-house repair center

### *InstraView*<sup>SM</sup> REMOTE INSPECTION

Remotely inspect equipment before purchasing with our interactive website at [www.instraview.com](http://www.instraview.com) ↗

### WE BUY USED EQUIPMENT

Sell your excess, underutilized, and idle used equipment. We also offer credit for buy-backs and trade-ins. [www.artisanng.com/WeBuyEquipment](http://www.artisanng.com/WeBuyEquipment) ↗

### LOOKING FOR MORE INFORMATION?

Visit us on the web at [www.artisanng.com](http://www.artisanng.com) ↗ for more information on price quotations, drivers, technical specifications, manuals, and documentation

**Contact us:** (888) 88-SOURCE | [sales@artisanng.com](mailto:sales@artisanng.com) | [www.artisanng.com](http://www.artisanng.com)