



# Artisan Scientific

QUALITY INSTRUMENTATION ... GUARANTEED

## Looking for more information?

Visit us on the web at <http://www.artisan-scientific.com> for more information:

- Price Quotations
- Drivers
- Technical Specifications, Manuals and Documentation

## Artisan Scientific is Your Source for Quality New and Certified-Used/Pre-owned Equipment

- Tens of Thousands of In-Stock Items
- Hundreds of Manufacturers Supported
- Fast Shipping and Delivery
- Leasing / Monthly Rentals
- Equipment Demos
- Consignment

### Service Center Repairs

Experienced Engineers and Technicians on staff in our State-of-the-art Full-Service In-House Service Center Facility

### InstraView™ Remote Inspection

Remotely inspect equipment before purchasing with our Innovative InstraView™ website at <http://www.instraview.com>

### We buy used equipment! We also offer credit for Buy-Backs and Trade-Ins

Sell your excess, underutilized, and idle used equipment. Contact one of our Customer Service Representatives today!

Talk to a live person: 888-88-SOURCE (888-887-6872) | Contact us by email: [sales@artisan-scientific.com](mailto:sales@artisan-scientific.com) | Visit our website: <http://www.artisan-scientific.com>

# *FlatPAC Family*

## *50 to 600 Watt*

### *AC-DC Switchers*

*Application Notes*  
*Functional and Mechanical Layout*  
*Installation and Operation Guidelines*



*F-Series*  
*(Strappable Input)*  
*A-Series*  
*(Autoranging Input)*

### **Product Description**

The FlatPAC family of user-definable offline power supplies provides a complete power solution that incorporates one, two, or three standard Vicor DC-DC converters and a front-end subassembly in a modular package. FlatPAC is available with one, two, or three outputs and total output ratings of up to 600 W. The two-up and three-up models (maximum output 400 W and 600 W) feature an autoranging input, which automatically senses the input line voltage and sets the power supply's input range accordingly. FlatPAC's unique modular design accommodates over 10,000 different configurations.

FlatPAC switchers that contain BatMod current source modules instead of VI-200 converters are indicated by the suffix -BM following the FlatPAC part number. BatMod converters provide a programmable output current, rather than a controlled output voltage. Consequently, the output supervisory terminal functions differ on FlatPACs with BatMod modules.



## AC Mains Connections

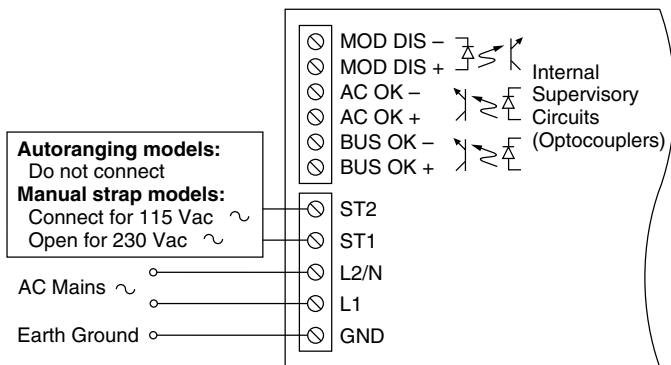

## Supervisory Connections (2-up and 3-up models)

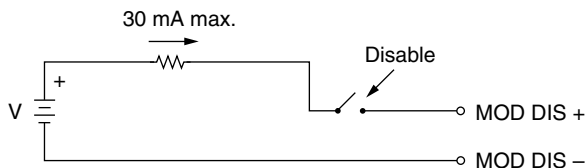

**MOD-DIS Input.** Apply a current of 1–30 mA to disable output. Forward voltage drop of internal opto diode is 1.65 V max. @ 30 mA max.

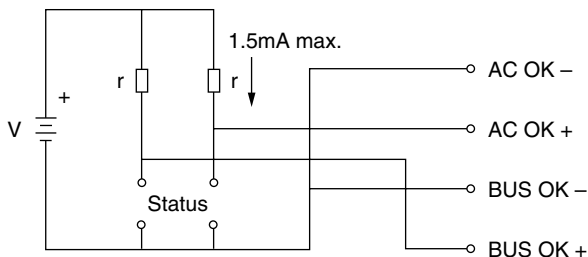

**AC-OK and BUS-OK Status Outputs.** Output transistors saturated if OK.  $V_{ce\ sat.} = < 0.4\text{ V}$  @ 1.5 mA. Maximum voltage is 70 Vdc.

### Timing Diagram—Status Signals (2-up and 3-up models)

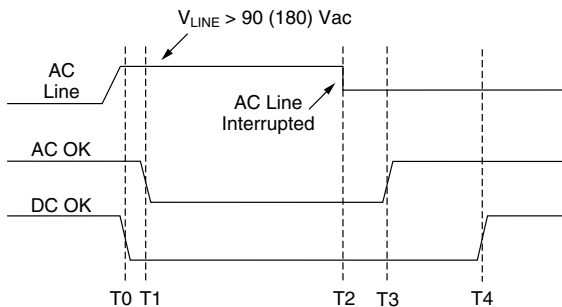

Conditions: Full Load 90 (180) Vac, AC Line

Time Interval	Min	Typ	Max	Units	Notes
T1-T0	0	0.1	1.0	ms	
T3-T2	0	—	—	ms	
T4-T2	5	—	—	ms	Ride-through time
T4-T3	5	—	—	ms	AC fail warning time

### Output Trimming (All models with VI-200s)

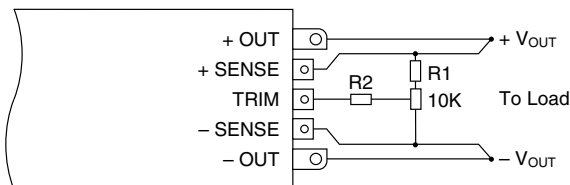

+Sense and -Sense must be connected locally or remotely (shown).

### RESISTOR VALUES FOR TRIMMING STANDARD OUTPUT VOLTAGES

Nominal Output Voltage	5 V	12 V	15 V	24 V	28 V	48 V	Trim Range
R1(k $\Omega$ )	.953	15.8	22.1	41.2	48.7	90.9	+10%, -10%
R2(k $\Omega$ )	90	90	90	90	90	90	

### Typical Applications (FlatPACs with BatMods only)

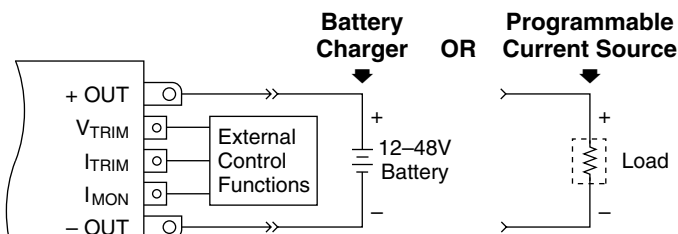

## LF-Series

Single output  
50-200 W

## MA/MF-Series

Single output  
200-400 W

## NA/NF-Series

Single output  
450-600 W

## PA/PF-Series

Dual output  
100-400 W

## QA/QF-Series

Dual output  
250-600 W

## RA/RF-Series

Triple output  
150-600 W

## Inputs

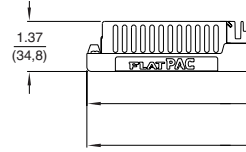

### All Models

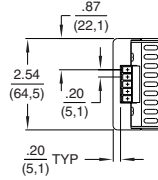

### LF-Series

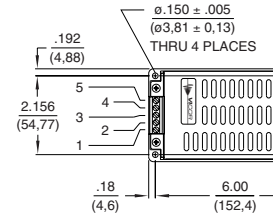

### MA-, PA-Series

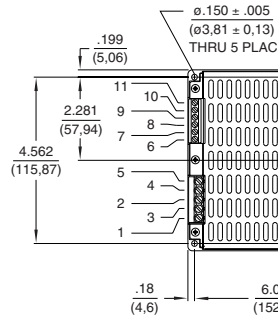
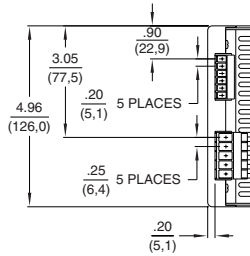

### NA-, QA-, and RA-Series

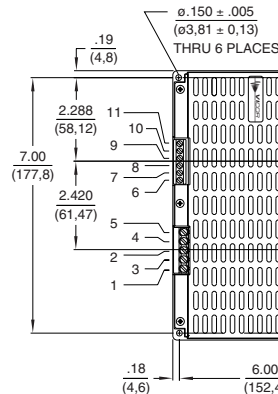
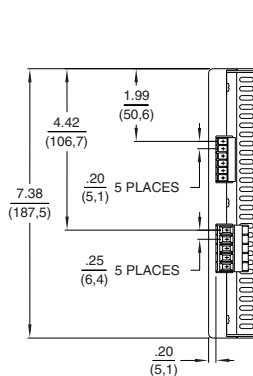

## Outputs

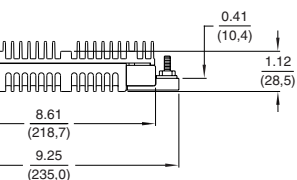

### LF-Series

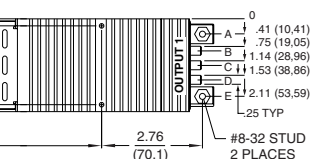

### MA-Series

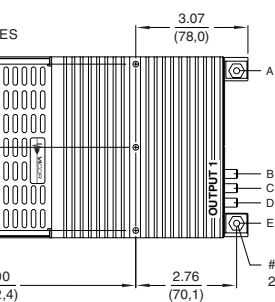

### PA-Series

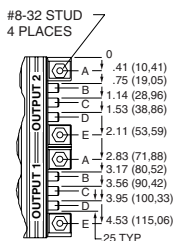

### NA-Series

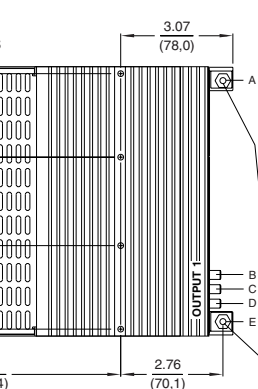

### QA-Series

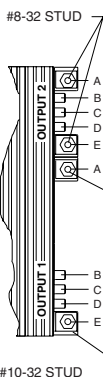

### RA-Series

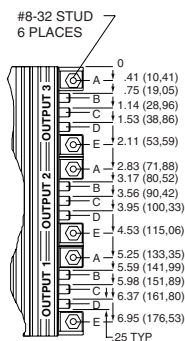

## Inputs

- 1 Earthground
- 2 L1
- 3 L2/N
- 4 <sup>1</sup>ST1
- 5 <sup>1</sup>ST2
- 6 BUS OK+
- 7 BUS OK-
- 8 AC OK+
- 9 AC OK-
- 10 MOD DIS+
- 11 MOD DIS-

<sup>1</sup> Not used on autoranging models

## Outputs

- A +Out
- B +Sense\*
- C Trim\*
- D -Sense\*
- E -Out

\*On FlatPACs with BatMods:

- B V<sub>TRIM</sub>
- C I<sub>TRIM</sub>
- D I<sub>MON</sub>

**Fusing.** The FlatPAC's internal fuses are not user-replaceable. Please return the unit to vendor if servicing is necessary.

**Grounding.** For safe operation, the FlatPAC unit must be grounded. Connect a ground lead to the terminal marked  $\frac{1}{\text{GND}}$  (GND). Use the same wire gauge as that specified for your FlatPAC unit's input voltage connections, below.

**Input Voltage Connections.** Connect the line voltage to L1 (hot) and L2N (neutral). For one-up FlatPAC models (max. output 200 W), use #16 input wire; for two-up and three-up models (max. output 400 W and 600 W), use #14 input wire. Recommended connector screw torque is 5 to 7 in-lbs (0.5 to 0.8 N-m). Use your FlatPAC model only with the corresponding input voltages and frequencies shown in the table below. *Either connect or do not connect ST1 to ST2 as indicated.*

C-Grade	Model	90–132 Vac	180–264 Vac
		47–63 Hz	
Strappable	VI-□F-C□	Connect	Open
Autoranging	VI-□A-C□	Open	Open
I-Grade	Model	90–132 Vac	180–264 Vac
		47–440 Hz	
Strappable	VI-□F-I□	Connect	Open
Autoranging	VI-□A-I□	Open	Open

**Output Wire Gauge.** Use the output wire gauge that corresponds to the output current of your FlatPAC unit, below:

105 A–160 A : #4	26 A–40 A : #10	7 A–10 A : #16
66 A–104 A : #6	16 A–25 A : #12	4 A–6 A : #18
41 A–65 A : #8	11 A–15 A : #14	0 A–3 A : #20

**Output Voltage Trimming.** Do not trim the outputs higher than 110% of their nominal output voltage. When an output is trimmed up, do not exceed its maximum rated output power.

**Operating Temperature.** Do not allow the FlatPAC to exceed its maximum operating temperature, which is reached when the heat sink is 85°C. (Full power can be delivered up to this temperature.) Heat sink temperature is a function of the output power and voltage of the supply, ambient temperature, and airflow across the heat sink. Refer to the Vicor Applications Manual to determine the maximum ambient temperature for your application. Always use worst-case conditions when calculating operating temperature. **Note:** To ensure proper heat transfer from the internal module(s) to the heat sink, the mounting holes through the heat sink (2, 3, and 4 holes on one-, two-, and three-up models, respectively) must contain torqued screws at all times during operation, whether or not the unit is mounted.

If the unit is operated unmounted, insert a #6 or metric screw through each hole from below and secure with a nut on top, torqued to 6 in-lbs (0.7 N-m).

**Output Terminal Connections.** A hardware kit with parts for output terminal connections is provided with each FlatPAC unit. The following drawing shows the assembly of those parts for the proper connection of metal power terminals.

Assembly for PCB power terminals is the same except that they do not require an external tooth lockwasher. Consult the table below for the recommended torque level for each stud size.

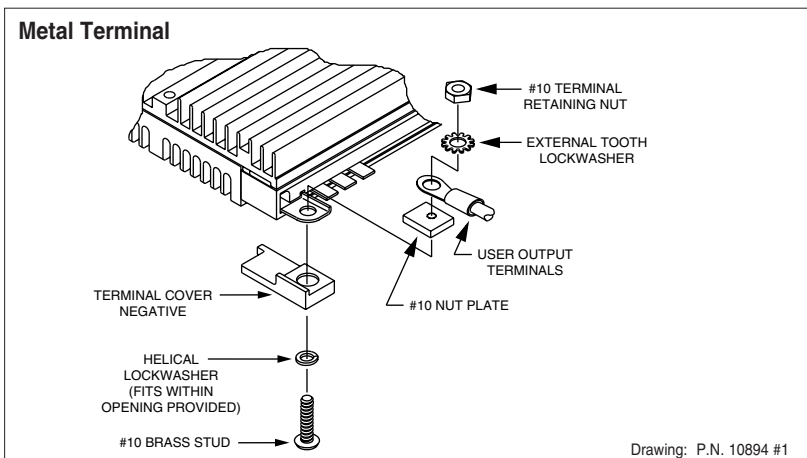

<i>Terminal and Product Model</i>	<i>Terminal Style</i>	<i>Stud Size</i>	<i>Recommended Torque</i>
<b>-Output, +Output</b>			
LF-, PA/PF-, & RA/RF-Series	PCB	8-32 UNC	10 in-lbs (1.1 N-m)
MA/MF- & NA/NF-Series	Metal	10-32 UNC	15 in-lbs (1.7 N-m)
QA/QF-Series	PCB Metal	8-32 UNC 10-32 UNC	10 in-lbs (1.1 N-m) 15 in-lbs (1.7 N-m)
<b>Supervisory</b> All models	Sized to accept AMP Faston® insulated receptacle #2-520184-2		

## For More Information

The Vicor Applications Manual and product data sheet contain complete information about FlatPAC AC-DC Switchers. To receive literature or to consult an applications engineer about installation or operation of this product, contact your nearest Vicor office. (See page 8.)

*(Bitte lesen Sie die Sicherheits-Vorschriften auf Seite 8.)*



**Sicherungen.** Die internen Sicherungen im FlatPAC können nicht vom Anwender ausgetauscht werden. Für Servicearbeiten schicken Sie das Teil bitte an den Händler zurück.

**Erdung.** Um den IEC 950 Klasse I Erdungsforderungen zu entsprechen, muß ein Erdungskabel an den Anschluß  $\perp$  (GND) angeschlossen werden. Für FlatPAC Modelle mit einem Modul (max. Leistung 200W) benutzen Sie bitte AWG 16- und für Modelle mit 2 und 3 Modulen (max. Leistung 400 W und 600 W) AWG 14-Kabel.

**Eingangverbindungen.** Abhängig von Ihrem FlatPAC Modell und der Eingangsspannung müssen ST1 und ST2 offen sein oder miteinander verbunden werden—wie nachstehend aufgeführt.

<i>Modell</i>	<i>90-132 Vac</i>	<i>180-264 Vac</i>
Strappable (VI-□F-□□)	Verbinden	Offen
Autoranging (VI-□A-□□)	Offen	Offen

**Betriebstemperatur.** Die maximale Betriebstemperatur des FlatPAC-Gerätes darf nicht überschritten werden. Dies ist gegeben, wenn der Kühlkörper eine Temperatur von 85 Grad Celsius erreicht hat.

**Weitere Informationen.** Das Vicor Applications Manual und Produkt-Datenblätter enthalten ausführliche Informationen über FlatPAC AC-DC Wandler. Fordern Sie bitte Unterlagen bei Vicor oder Ihrer nächsten Vicor Vertretung an.

Visit Vicor's Website at:  
**vicorpower.com**

**Vicor Corporation**

Andover, MA, U.S.A  
Tel: 978-470-2900  
Fax: 978-475-6715

Chicago, IL  
Tel: 630-769-8780  
Fax: 630-769-8782

Sunnyvale, CA  
Tel: 408-522-5280  
Fax: 408-774-5555

**Vicor France**

Tel: +33 1 34 52 18 30  
Fax: +33 1 34 52 28 30

**Vicor Italy**

Tel: +39 02 22 47 23 26  
Fax: +39 02 22 47 31 66

**Vicor Hong Kong**

Tel: +852-2956-1782  
Fax: +852-2956-0782

**Vicor Germany**

Tel: +49 89 962 439 0  
Fax: +49 89 962 439 39

**Vicor U.K.**

Tel: +44 1276 678222  
Fax: +44 1276 681269

**Vicor Japan**

Tel: +81-3-5487-3880  
Fax: +81-3-5487-3885



# Artisan Scientific

QUALITY INSTRUMENTATION ... GUARANTEED

## Looking for more information?

Visit us on the web at <http://www.artisan-scientific.com> for more information:

- Price Quotations
- Drivers
- Technical Specifications, Manuals and Documentation

## Artisan Scientific is Your Source for Quality New and Certified-Used/Pre-owned Equipment

- Tens of Thousands of In-Stock Items
- Hundreds of Manufacturers Supported
- Fast Shipping and Delivery
- Leasing / Monthly Rentals
- Equipment Demos
- Consignment

### Service Center Repairs

Experienced Engineers and Technicians on staff in our State-of-the-art Full-Service In-House Service Center Facility

### InstraView™ Remote Inspection

Remotely inspect equipment before purchasing with our Innovative InstraView™ website at <http://www.instraview.com>

### We buy used equipment! We also offer credit for Buy-Backs and Trade-Ins

Sell your excess, underutilized, and idle used equipment. Contact one of our Customer Service Representatives today!

Talk to a live person: 888-88-SOURCE (888-887-6872) | Contact us by email: [sales@artisan-scientific.com](mailto:sales@artisan-scientific.com) | Visit our website: <http://www.artisan-scientific.com>